

Altova XMLSpy 2024 Professional Edition



User & Reference Manual

Altova XMLSpy 2024 Professional Edition User & Reference Manual

All rights reserved. No parts of this work may be reproduced in any form or by any means - graphic, electronic, or mechanical, including photocopying, recording, taping, or information storage and retrieval systems - without the written permission of the publisher.

Products that are referred to in this document may be either trademarks and/or registered trademarks of the respective owners. The publisher and the author make no claim to these trademarks.

While every precaution has been taken in the preparation of this document, the publisher and the author assume no responsibility for errors or omissions, or for damages resulting from the use of information contained in this document or from the use of programs and source code that may accompany it. In no event shall the publisher and the author be liable for any loss of profit or any other commercial damage caused or alleged to have been caused directly or indirectly by this document.

Published: 2024

© 2018-2024 Altova GmbH

Table of Contents

1	About XMLSpy and This Documentation	22
1.1	New Features 2024.....	23
1.1.1	Version 2023.....	23
1.1.2	Version 2022.....	24
1.1.3	Version 2021.....	25
1.1.4	Version 2020.....	26
1.2	Windows File Paths.....	28
1.3	About RaptorXML Server.....	29
2	XMLSpy Tutorial	30
2.1	XMLSpy Interface.....	31
2.1.1	The Views.....	32
2.1.2	The Windows.....	33
2.1.3	Menus and Toolbars.....	35
2.1.4	Text View Settings.....	37
2.1.5	Application Options.....	40
2.2	XML Schemas: Basics.....	42
2.2.1	Creating a New XML Schema File.....	42
2.2.2	Defining Namespaces.....	44
2.2.3	Defining a Content Model.....	45
2.2.4	Adding Elements with Drag-and-Drop.....	50
2.2.5	Configuring the Content Model View.....	51
2.2.6	Completing the Basic Schema.....	53
2.3	XML Schemas: Advanced.....	57
2.3.1	Working with Complex Types and Simple Types.....	57
2.3.2	Referencing Global Elements.....	65
2.3.3	Attributes and Attribute Enumerations.....	67
2.4	XML Schemas: XMLSpy Features.....	70
2.4.1	Schema Navigation.....	70

2.4.2	Schema Documentation.....	72
2.5	XML Documents.....	77
2.5.1	Creating a New XML File.....	77
2.5.2	Specifying the Type of an Element.....	79
2.5.3	Entering Data in Grid View.....	81
2.5.4	Entering Data in Text View.....	82
2.5.5	Validating the Document.....	87
2.5.6	Adding Elements and Attributes.....	91
2.5.7	Editing in Table Display.....	93
2.5.8	Modifying the Schema.....	96
2.6	XSLT Transformations.....	98
2.6.1	Assigning an XSLT File.....	98
2.6.2	Transforming the XML File.....	99
2.6.3	Modifying the XSL File.....	100
2.7	Project Management.....	102
2.7.1	Benefits of Projects.....	102
2.7.2	Building a Project.....	102
2.8	That's It.....	105

3 GUI and Environment 106

3.1	The Graphical User Interface (GUI).....	107
3.1.1	Main Window.....	108
3.1.2	Project Window.....	110
3.1.3	Info Window.....	112
3.1.4	Entry Helpers.....	112
3.1.5	Output Window: Messages.....	113
3.1.6	Output Window: XPath/XQuery.....	115
3.1.7	Output Window: XSL Outline.....	116
3.1.8	Output Window: HTTP.....	116
3.1.9	Output Window: Find in Files.....	117
3.1.10	Output Window: Find in Schemas.....	119
3.1.11	Menu Bar, Toolbars, Status Bar.....	119
3.2	The Application Environment.....	121
3.2.1	Settings and Customization.....	121

3.2.2	Tutorials, Projects, Examples.....	124
3.2.3	XMLSpy Features and Help, and Altova Products.....	124
4	Editing Views	126
4.1	Automatic Backup of Files.....	128
4.2	Text View.....	130
4.2.1	Formatting in Text View.....	131
4.2.2	Displaying the Document.....	133
4.2.3	Editing in Text View.....	136
4.2.4	Navigating the Document.....	139
4.2.5	Entry Helpers in Text View.....	142
4.2.6	Split View.....	143
4.2.7	Text View Shortcuts.....	144
4.3	Grid View.....	146
4.3.1	Document Display.....	147
4.3.2	Document Structure.....	155
4.3.3	Document Content.....	156
4.3.4	Split View.....	160
4.3.5	Entry Helpers.....	162
4.3.6	Table Display (XML).....	163
4.3.7	Table Display (JSON).....	167
4.3.8	Drag-and-Drop (XML).....	172
4.3.9	Drag-and-Drop (JSON).....	174
4.3.10	Formulas (XML).....	177
4.3.11	Formulas (JSON).....	180
4.3.12	Filters	184
4.3.13	Images.....	187
4.3.14	Context Menu.....	189
4.3.15	Grid View Settings.....	192
4.4	Schema View.....	198
4.4.1	XSD Mode: XSD 1.0 or 1.1.....	200
4.4.2	Schema Overview.....	204
4.4.3	Content Model View.....	216
4.4.4	Attributes, Assertions, and Identity Constraints.....	237

4.4.5	Entry Helpers in Schema View.....	252
4.4.6	Validation and Smart Fixes.....	262
4.4.7	Assertion Messages.....	263
4.4.8	Base Type Modification.....	266
4.4.9	Smart Restrictions.....	267
4.4.10	xml:base, xml:id, xml:lang, xml:space.....	272
4.4.11	Back and Forward: Moving through Positions.....	273
4.5	Authentic View.....	275
4.6	Browser View.....	276
4.7	Archive View.....	278
4.8	Common Shortcuts.....	280

5 XML 282

5.1	Creating, Opening, and Saving XML Documents.....	283
5.2	Assigning Schemas and Validating.....	285
5.3	XML in Text View.....	287
5.4	XML in Grid View.....	290
5.5	XML in Authentic View.....	291
5.6	Entry Helpers (Text View, Authentic View).....	293
5.7	Validating XML Documents.....	294
5.8	Whitespace.....	296
5.9	Inserting XML Fragments.....	298
5.10	Processing with XSLT and XQuery.....	300
5.11	PDF Fonts.....	302
5.12	Additional Features.....	305

6 DTDs and XML Schemas 306

6.1	Schema Manager.....	307
6.1.1	Run Schema Manager.....	310
6.1.2	Status Categories.....	312
6.1.3	Patch or Install a Schema.....	314
6.1.4	Uninstall a Schema, Reset.....	315
6.1.5	Command Line Interface (CLI).....	316

6.2	DTDs.....	323
6.3	XML Schemas.....	326
6.4	Schema Subsets.....	327
6.5	Catalogs in XMLSpy.....	331
6.5.1	How Catalogs Work.....	331
6.5.2	Catalog Structure in XMLSpy.....	332
6.5.3	Customizing Your Catalogs.....	333
6.5.4	Environment Variables.....	335
6.6	Working with SchemaAgent.....	337
6.6.1	Connecting to SchemaAgent Server.....	338
6.6.2	Opening Schemas Found in the Search Path.....	340
6.6.3	Using IIRs.....	341
6.6.4	Viewing Schemas in SchemaAgent.....	345
6.6.5	SchemaAgent Validation.....	345
6.7	Find in Schemas.....	348
6.7.1	Search Term.....	350
6.7.2	Components.....	351
6.7.3	Properties.....	353
6.7.4	Scope.....	356
6.7.5	Find and Replace Commands.....	357
6.7.6	Results and Information.....	359
6.7.7	Finding and Renaming Globals.....	360
7	XSLT	362
7.1	XSLT Documents.....	363
7.2	XSLT Processing.....	365
7.3	XSL Outline.....	367
7.3.1	XSL Outline Window.....	368
7.3.2	Info Window.....	371
8	XQuery	374
8.1	Editing XQuery Documents.....	376
8.1.1	XQuery Documents.....	377

8.1.2	XQuery Entry Helpers.....	378
8.1.3	XQuery Syntax Coloring.....	378
8.1.4	XQuery Intelligent Editing.....	380
8.2	XQuery Evaluation.....	383
8.3	XQuery Validation.....	384
8.4	XQuery/Update Execution.....	385
8.5	XQuery Update Facility.....	387
8.5.1	Previewing and Applying Updates.....	387
8.5.2	Update Operations and Syntax.....	390
8.6	XQuery and XML Databases.....	394
9	XSLT/XQuery Debugger and Profiler	398
9.1	XSLT and XQuery Debugger.....	399
9.1.1	Mechanism and Interface.....	400
9.1.2	Commands and Toolbar Icons.....	402
9.1.3	Breakpoints.....	404
9.1.4	Tracepoints.....	406
9.1.5	Information Windows.....	410
9.1.6	Debugger Settings.....	417
10	XPath/XQuery Expressions	419
10.1	About the XPath/XQuery Window.....	420
10.2	Evaluating the Expression.....	422
10.3	Debugging the Expression.....	428
10.4	Expression Builder.....	436
10.5	XQuery Expressions for JSON.....	439
10.6	Points to Note.....	442
11	Authentic	444
11.1	Authentic View Tutorial.....	446
11.1.1	Opening an XML Document in Authentic View.....	447
11.1.2	The Authentic View Interface.....	448
11.1.3	Node Operations.....	451

11.1.4	Entering Data in Authentic View.....	454
11.1.5	Entering Attribute Values.....	456
11.1.6	Adding Entities.....	457
11.1.7	Printing the Document.....	458
11.2	Authentic View Interface.....	459
11.2.1	Overview of the GUI.....	459
11.2.2	Authentic View Toolbar Icons.....	460
11.2.3	Authentic View Main Window.....	463
11.2.4	Authentic View Entry Helpers.....	465
11.2.5	Authentic View Context Menus.....	469
11.3	Editing in Authentic View.....	472
11.3.1	Basic Editing.....	472
11.3.2	Tables in Authentic View.....	477
11.3.3	Editing a DB.....	484
11.3.4	Working with Dates.....	490
11.3.5	Defining Entities.....	492
11.3.6	XML Signatures.....	494
11.3.7	Images in Authentic View.....	495
11.3.8	Keystrokes in Authentic View.....	496
11.4	Authentic Scripting.....	497
12	HTML and CSS	499
12.1	HTML.....	500
12.2	CSS.....	502
13	JSON, JSON Schema	507
13.1	JSON Data.....	509
13.2	JSON Schema.....	512
13.3	JSON Lines and JSON Comments.....	514
13.4	JSON Text View.....	515
13.5	JSON Grid View.....	520
13.6	JSON Schema View.....	523
13.6.1	JSON Schema Version.....	524

13.6.2	Adding Global Definitions.....	526
13.6.3	Entry Helpers: Overview, Details, Constraints.....	527
13.6.4	Global and Local Definitions.....	530
13.6.5	Design View.....	532
13.6.6	Objects and Properties.....	533
13.6.7	Unspecified Properties.....	537
13.6.8	Objects and Dependencies.....	540
13.6.9	Arrays	544
13.6.10	Atomic Types.....	546
13.6.11	Type Selectors (Any, Multiple, etc).....	548
13.6.12	BSON (Binary JSON) for MongoDB.....	550
13.6.13	Operators.....	554
13.6.14	Conditionals.....	556
13.6.15	Configuring Design View.....	557
13.6.16	Generating JSON Schema Documentation.....	558
13.7	Validate JSON Documents.....	561
13.8	Insert JSON Fragments.....	563
13.9	JSON Transformations with XSLT/XQuery.....	565
13.10	XQuery Expressions for JSON.....	567
13.11	Generate JSON Schema from JSON Instance.....	569
13.12	Generate JSON Instance from JSON Schema.....	572
13.13	Convert between JSON and XML.....	573
14	YAML	574
14.1	Create and Validate YAML Documents.....	575
14.2	YAML Text View.....	577
14.3	Generate JSON Schema from YAML Document.....	578
14.4	Generate YAML Document from JSON Schema.....	581
14.5	Convert between YAML and JSON/XML.....	582
15	HTTP	583
15.1	Sending the Request.....	584
15.2	Importing a Request to Send.....	589

15.3	Receiving the Response.....	591
16	Office Open XML, ZIP, EPUB	595
16.1	Working with OOXML Files.....	597
16.2	OOXML Example Files.....	599
16.3	ZIP Files.....	601
16.4	EPUB Files.....	603
17	Databases	607
17.1	Connecting to a Data Source.....	609
17.1.1	Start Database Connection Wizard.....	610
17.1.2	Database Drivers Overview.....	612
17.1.3	ADO Connection.....	615
17.1.4	ADO.NET Connection.....	621
17.1.5	ODBC Connection.....	628
17.1.6	JDBC Connection.....	631
17.1.7	SQLite Connection.....	635
17.1.8	Native Connection.....	638
17.1.9	Global Resources.....	639
17.1.10	Database Connection Examples.....	640
17.2	Supported Databases.....	695
18	Altova Global Resources	696
18.1	Defining Global Resources.....	697
18.1.1	Files	699
18.1.2	Folders.....	704
18.1.3	Databases.....	706
18.2	Using Global Resources.....	708
18.2.1	Assigning Files and Folders.....	708
18.2.2	Assigning Databases.....	711
18.2.3	Changing the Active Configuration.....	712

19	Projects	714
19.1	Creating and Editing Projects.....	715
19.2	Using Projects.....	719
20	RaptorXML(+XBRL) Server	721
20.1	Adding Servers and Server Configurations.....	722
20.2	Validating with RaptorXML Server.....	726
20.3	Validation Options.....	727
20.3.1	Common Options.....	727
20.3.2	XML with DTD.....	728
20.3.3	DTD	728
20.3.4	XML with W3C Schema.....	729
20.3.5	W3C Schema.....	730
20.3.6	XSLT	730
20.3.7	XQuery.....	731
20.3.8	JSON	732
20.3.9	JSON Schema.....	733
20.3.10	EDGAR.....	733
20.4	XSLT and XQuery with RaptorXML Server.....	736
21	File/Directory Comparisons	738
21.1	File Comparisons.....	739
21.2	Directory Comparisons.....	740
22	Source Control	742
22.1	Setting Up Source Control.....	744
22.2	Supported Source Control Systems.....	745
22.3	Local Workspace Folder.....	747
22.4	Application Project.....	748
22.5	Add to Source Control.....	750
22.6	Working with Source Control.....	752

22.6.1	Add to, Remove from Source Control.....	752
22.6.2	Check Out, Check In.....	753
22.6.3	Getting Files as Read-Only.....	755
22.6.4	Copying and Sharing from Source Control.....	757
22.6.5	Changing Source Control.....	760
22.7	Source Control with Git.....	762
22.7.1	Enabling Git Source Control with GIT SCC Plug-in.....	763
22.7.2	Adding a Project to Git Source Control.....	763
22.7.3	Cloning a Project from Git Source Control.....	765

23 XMLSpy in Visual Studio 767

23.1	Installing the XMLSpy Plugin.....	768
23.2	Differences with XMLSpy Standalone.....	769
23.3	XMLSpy's Debuggers in Visual Studio.....	771

24 XMLSpy in Eclipse 772

24.1	Install the Integration Package for Eclipse.....	773
24.2	XMLSpy Perspective in Eclipse.....	775
24.3	Other XMLSpy Entry Points in Eclipse.....	778
24.4	XMLSpy's Debugger Perspectives.....	780

25 Menu Commands 781

25.1	File Menu.....	782
25.1.1	New	782
25.1.2	Open	787
25.1.3	Reload.....	792
25.1.4	Encoding.....	792
25.1.5	Close, Close All, Close All But Active.....	793
25.1.6	Save, Save As, Save All.....	793
25.1.7	Send by Mail.....	798
25.1.8	Print	799
25.1.9	Print Preview, Print Setup.....	800
25.1.10	Recent Files, Exit.....	801

25.2	Edit Menu.....	803
25.2.1	Undo, Redo.....	804
25.2.2	Cut, Copy, Paste, Delete.....	804
25.2.3	Copy as XML/JSON Text.....	805
25.2.4	Copy as Tab-Separated Text.....	806
25.2.5	Copy as Image.....	806
25.2.6	Copy XPath.....	807
25.2.7	Copy XPath/JSON-Pointer.....	807
25.2.8	Insert	807
25.2.9	Save as Image.....	811
25.2.10	Pretty-Print.....	812
25.2.11	Strip Whitespaces.....	812
25.2.12	Select All.....	812
25.2.13	Find, Find Next.....	812
25.2.14	Replace.....	818
25.2.15	Find in Files.....	819
25.2.16	Bookmark Commands.....	821
25.2.17	Comment In/Out.....	822
25.3	Project Menu.....	823
25.3.1	New Project.....	825
25.3.2	Open Project.....	826
25.3.3	Reload Project.....	826
25.3.4	Close Project.....	826
25.3.5	Save Project, Save Project As.....	826
25.3.6	Source Control.....	827
25.3.7	Add Files to Project.....	840
25.3.8	Add Global Resource to Project.....	841
25.3.9	Add URL to Project.....	841
25.3.10	Add Active File to Project.....	841
25.3.11	Add Active And Related Files to Project.....	841
25.3.12	Add Project Folder to Project.....	842
25.3.13	Add External Folder to Project.....	842
25.3.14	Add External Web Folder to Project.....	844
25.3.15	Script Settings.....	848
25.3.16	Properties.....	849

25.3.17	Most Recently Used Projects.....	852
25.4	XML Menu.....	853
25.4.1	Type	853
25.4.2	Insert After/Before.....	854
25.4.3	Append, Add Child.....	854
25.4.4	Wrap in Element.....	854
25.4.5	Edit as Raw Text.....	854
25.4.6	Move Up/Down/Left/Right.....	855
25.4.7	Display as Table.....	855
25.4.8	Ascending/Descending Sort.....	855
25.4.9	Flip Rows/Columns.....	855
25.4.10	Evaluate XPath.....	856
25.4.11	Check Well-Formedness.....	856
25.4.12	Validate XML.....	857
25.4.13	Validate XML on Server (high-performance).....	861
25.4.14	Validating WSDL Files.....	862
25.4.15	Validate on Edit.....	863
25.4.16	Update Entry Helpers.....	863
25.4.17	Namespace Prefix.....	863
25.5	JSON Menu.....	864
25.5.1	Type	865
25.5.2	Insert After/Before, Append, Add Child.....	865
25.5.3	Wrap in Array/Object.....	865
25.5.4	Move	866
25.5.5	Display as Table.....	866
25.5.6	Ascending/Descending Sort.....	866
25.5.7	Flip Rows/Columns.....	866
25.5.8	Remove Comments, Re-evaluate All.....	867
25.6	DTD/Schema Menu.....	868
25.6.1	Assign DTD.....	868
25.6.2	Assign Schema.....	869
25.6.3	Include Another DTD.....	870
25.6.4	Go to DTD.....	871
25.6.5	Go to Schema.....	871
25.6.6	Go to Definition.....	871

25.6.7	Generate DTD/Schema.....	872
25.6.8	Flatten DTD.....	874
25.6.9	Convert DTD to Schema.....	874
25.6.10	Flatten Schema.....	877
25.6.11	Convert Schema to DTD.....	877
25.6.12	Convert to UML.....	878
25.6.13	Generate XML from DB, Excel, EDI with MapForce.....	879
25.6.14	Design HTML/PDF/Word Output with StyleVision.....	879
25.6.15	Generate Sample XML/JSON File.....	879
25.6.16	Flush Memory Cache.....	883
25.7	Schema Design Menu.....	884
25.7.1	Schema Settings.....	884
25.7.2	Save Diagram.....	887
25.7.3	Generate Documentation.....	887
25.7.4	Configure View.....	893
25.7.5	Zoom	896
25.7.6	Display All Globals.....	896
25.7.7	Display Diagram.....	896
25.7.8	Schema Extensions for Databases.....	897
25.7.9	Connect to SchemaAgent Server.....	901
25.7.10	Disconnect from SchemaAgent Server.....	902
25.7.11	Show in SchemaAgent.....	902
25.7.12	SchemaAgent Validation.....	902
25.7.13	Create Schema Subset.....	903
25.7.14	Flatten Schema.....	904
25.8	XSL/XQuery Menu.....	906
25.8.1	XSL Transformation.....	907
25.8.2	XSL-FO Transformation.....	908
25.8.3	XSL Parameters / XQuery Variables.....	910
25.8.4	XQuery/Update Execution.....	913
25.8.5	Assign XSL.....	913
25.8.6	Assign XSL-FO.....	914
25.8.7	Assign Sample XML File.....	914
25.8.8	Go to XSL.....	914
25.8.9	Start Debugger / Go.....	915

25.8.10	Stop Debugger.....	915
25.8.11	Restart Debugger.....	915
25.8.12	End Debugger Session.....	915
25.8.13	Step Into.....	916
25.8.14	Step Out.....	916
25.8.15	Step Over.....	916
25.8.16	Show Current Execution Node.....	916
25.8.17	Insert/Remove Breakpoint.....	917
25.8.18	Insert/Remove T racepoint.....	917
25.8.19	Enable/Disable Breakpoint.....	917
25.8.20	Enable/Disable T racepoint.....	917
25.8.21	Breakpoints/T racepoints.....	918
25.8.22	Debug Windows.....	919
25.8.23	Debug Settings.....	919
25.9	Authentic Menu.....	920
25.9.1	New Document.....	921
25.9.2	Edit Database Data.....	922
25.9.3	Assign a StyleVision Stylesheet.....	922
25.9.4	Edit StyleVision Stylesheet.....	923
25.9.5	Select New Row with XML Data for Editing.....	923
25.9.6	XML Signature.....	924
25.9.7	Define XML Entities.....	926
25.9.8	View Markup.....	928
25.9.9	RichEdit.....	928
25.9.10	Append/Insert/Duplicate/Delete Row.....	929
25.9.11	Collapse/Expand Markup.....	929
25.9.12	Move Row, Delete Row.....	929
25.9.13	Generate HTML, RTF, PDF, Word 2007+ Document.....	930
25.9.14	Trusted Locations.....	930
25.10	DB Menu.....	932
25.10.1	Query Database.....	932
25.10.2	IBM DB2.....	948
25.10.3	SQL Server.....	953
25.10.4	Oracle XML DB.....	956
25.11	Convert Menu.....	961

25.11.1	Import Text File.....	961
25.11.2	Import Database Data.....	964
25.11.3	Import Microsoft Word Document.....	969
25.11.4	Create XML Schema from DB Structure.....	969
25.11.5	DB Import Based on XML Schema.....	974
25.11.6	Create DB Structure from XML Schema.....	975
25.11.7	Export to Text Files.....	978
25.11.8	Export to a Database.....	981
25.11.9	Convert XML Instance to/from JSON/YAML.....	984
25.11.10	Convert XML Schema to/from JSON Schema.....	987
25.11.11	Convert JSON to/from YAML.....	990
25.12	View Menu.....	991
25.12.1	Text View.....	991
25.12.2	Enhanced Grid View.....	992
25.12.3	Schema Design View.....	992
25.12.4	Authentic View.....	992
25.12.5	Browser View.....	993
25.12.6	Expand.....	993
25.12.7	Collapse.....	993
25.12.8	Expand Fully.....	994
25.12.9	Collapse Unselected.....	994
25.12.10	Optimal Widths.....	994
25.12.11	Word Wrap.....	994
25.12.12	Go to Line/Character.....	995
25.12.13	Go to File.....	995
25.12.14	Text View Settings.....	995
25.13	Browser Menu.....	998
25.14	Tools Menu.....	999
25.14.1	Spelling.....	1000
25.14.2	Spelling Options.....	1003
25.14.3	Scripting Editor.....	1007
25.14.4	Macros.....	1007
25.14.5	Comparisons.....	1008
25.14.6	User-Defined Tools.....	1017
25.14.7	Global Resources.....	1017

25.14.8	Active Configuration.....	1018
25.14.9	Manage Raptor Servers.....	1019
25.14.10	Raptor Servers and Configurations.....	1022
25.14.11	XML Schema Manager.....	1022
25.14.12	Customize.....	1022
25.14.13	Restore Toolbars and Windows.....	1040
25.14.14	Options.....	1040
25.15	Window Menu.....	1080
25.16	Help Menu.....	1083
25.16.1	Help	1083
25.16.2	Keyboard Map.....	1083
25.16.3	Activation, Order Form, Registration, Updates.....	1084
25.16.4	Other Commands.....	1088
25.17	Command Line.....	1089

26 Programmers' Reference 1090

26.1	Scripting Editor.....	1092
26.1.1	Creating a Scripting Project.....	1093
26.1.2	Built-in Commands.....	1106
26.1.3	Enabling Scripts and Macros.....	1116
26.2	IDE Plugins.....	1119
26.2.1	Registration of IDE Plugins.....	1119
26.2.2	ActiveX Controls.....	1120
26.2.3	Configuration XML.....	1120
26.2.4	ATL Sample Files.....	1123
26.2.5	IXMLSpyPlugIn.....	1128
26.3	Application API.....	1134
26.3.1	Overview.....	1135
26.3.2	Interfaces.....	1171
26.3.3	Interfaces (obsolete).....	1385
26.3.4	Enumerations.....	1422
26.3.5	Application API for Java (obsolete).....	1436
26.4	ActiveX Integration.....	1480
26.4.1	Prerequisites.....	1480

26.4.2	Adding the ActiveX Controls to the Toolbox.....	1481
26.4.3	Integration at Application Level.....	1483
26.4.4	Integration at Document Level.....	1485
26.4.5	ActiveX Integration Examples.....	1488
26.4.6	Command Reference.....	1501
26.4.7	Object Reference.....	1520

27 Appendices 1543

27.1	XSLT and XQuery Engine Information.....	1544
27.1.1	XSLT 1.0.....	1544
27.1.2	XSLT 2.0.....	1544
27.1.3	XSLT 3.0.....	1546
27.1.4	XQuery 1.0.....	1547
27.1.5	XQuery 3.1.....	1550
27.2	XSLT and XPath/XQuery Functions.....	1552
27.2.1	Altova Extension Functions.....	1553
27.2.2	Miscellaneous Extension Functions.....	1629
27.3	Datatypes in DB-Generated XML Schemas.....	1647
27.3.1	ADO	1647
27.3.2	MS Access.....	1648
27.3.3	MS SQL Server.....	1649
27.3.4	MySQL.....	1649
27.3.5	ODBC.....	1650
27.3.6	Oracle.....	1651
27.3.7	Sybase.....	1652
27.4	Datatypes in DBs Generated from XML Schemas.....	1653
27.4.1	MS Access.....	1653
27.4.2	MS SQL Server.....	1654
27.4.3	MySQL.....	1656
27.4.4	Oracle.....	1658
27.5	Technical Data.....	1661
27.5.1	OS and Memory Requirements.....	1661
27.5.2	Altova Engines.....	1661
27.5.3	Unicode Support.....	1662

27.5.4	Internet Usage.....	1662
27.6	License Information.....	1663
27.6.1	Electronic Software Distribution.....	1663
27.6.2	Software Activation and License Metering.....	1664
27.6.3	Altova End-User License Agreement.....	1665

Index	1666
--------------	-------------

1 About XMLSpy and This Documentation

[Altova XMLSpy 2024 Professional Edition](#) is a powerful XML and JSON editor for designing, editing, and debugging enterprise-class applications involving JSON, XML, XML Schema, XSLT, and XQuery. XMLSpy runs on Windows 10, Windows 11, and Windows Server 2016 or newer. XMLSpy is available in 64-bit and 32-bit versions and as part of the value-priced [Altova MissionKit](#) tool suite.



This documentation is organized into the following main sections:

- [A tutorial](#) ³⁰ to get you started
- Descriptions of XMLSpy features, organized by technology or XMLSpy-specific feature
- Descriptions of [menu commands](#) ⁷⁸¹
- [A programmers' reference](#) ¹⁰⁹⁰
- [Appendices](#) ¹⁵⁴³, which include information about XMLSpy's (i) XSLT and XQuery engines, and (ii) Altova's XPath/XQuery extension functions

Last updated: 8 April 2024

1.1 New Features 2024

Version 2024r2

- New [YAML](#) ⁵⁷⁴ conformance types have been added to enable the display and editing of [YAML documents](#) ⁵⁷⁴. Their default file extensions are `.yaml` and `.yml`.
- Text View now supports the [hierarchical viewing and intelligent editing of YAML documents](#) ⁵⁷⁷.
- You can define the [pretty-printing format of YAML documents](#) ¹⁰⁴⁸ in the [Options dialog](#) ¹⁰⁴⁸.
- YAML documents can be [validated against JSON schemas](#) ⁵⁷⁵.
- [JSON Schemas can be generated from YAML documents](#) ⁵⁷⁸.
- [YAML instance documents can be generated JSON Schemas](#) ⁵⁸¹.
- [YAML documents can be converted to and from JSON instance documents](#) ⁵⁸².
- The dialog to assign a schema to a document has been enhanced to now also directly install and assign schema packages. The feature is available in the following commands: [File | New](#) ⁷⁸², [DTD/Schema | Assign DTD](#) ⁸⁶⁸, and [DTD/Schema | Assign Schema](#) ⁸⁶⁹.
- In the context menu of a [Main Window tab](#) ¹⁰⁸, a new command enables you to directly open the containing archive of the active file if the file is part of a zip archive. The archive is opened in [Archive View](#) ²⁷⁸.
- [Database support](#) ⁶⁹⁵ has been extended to SQLite 3.45, MariaDB 11.2, MySQL 8.2 and 8.3, PostgreSQL 16.
- [Eclipse support](#) ⁷⁷² has been updated to cover the following versions: 2024-03; 2023-12; 2023-09; 2023-06.

Version 2024

- A new [AI-Assistant](#) ¹⁰⁸⁰ (**Window | AI-Assistant**) offers Artificial Intelligence help with various XMLSpy tasks. After you enter your OpenAI API key in the [Options dialog](#) ¹⁰⁷⁹, you can access the AI-Assistant to request AI help with your XML-related task or your XMLSpy-related question.
- In Grid View, in addition to being able to [set up sibling nodes to be displayed into sibling groups](#) ¹⁹² of 100, 1k, or 10k nodes, you can also specify that sibling nodes be displayed without grouping.
- Support has been added for the Markdown text format and the `.md` [file extension](#) ¹⁰⁴³. Text View supports the editing of Markdown files with [syntax highlighting](#) ¹⁰⁶¹. When a text with Markdown formatting is switched from Text View to [Browse View](#) ²⁷⁶, the Markdown formatting is converted to simple HTML formatting and the document is rendered in [Browse View](#) ²⁷⁶ as an HTML Page.
- The [HTTP output window](#) ⁵⁸³ now supports the saving and direct loading of HTTP requests.
- Images in XML Schema and JSON Schema [diagrams](#) ⁸⁸⁷ and [documentation](#) ⁸⁸⁹ can now be generated in SVG format—additionally to them being available for generation in PNG format.
- [Database support](#) ⁶⁹⁵ has been extended to SQLite 3.38.5.
- [Eclipse support](#) ⁷⁷² has been updated to cover the following versions: 2023-09; 2023-06; 2023-03; 2022-12.

1.1.1 Version 2023

Version 2023r2

- The [Help system](#)¹⁰⁸³ has been reorganized to provide Online Help by default, with [an option to use the locally installed PDF user manual](#)¹⁰⁷⁹ as the alternative default.
- Grid View has been enhanced with [Split Views](#)¹⁶⁰. This provides you with two views of a document that you are editing. As a result you can see and edit different parts of a long document side-by-side—instead of having to scroll a single view to refer to another part of the document.
- Settings have been added to define [network settings](#)¹⁰⁷⁶.
- [Database support](#)⁶⁹⁵ has been extended to: PostgreSQL 15.1, Microsoft SQL Server 2022.

Version 2023

- You can [select a classic, light, or dark theme](#)¹⁰⁸⁰ for the application. When a theme is active, its text display can be formatted separately for document type and view in the [Options dialog](#)¹⁰⁴⁰.
- An XMLSpy theme can also be selected for XMLSpy integrations in [Eclipse](#)⁷⁷² and [Visual Studio](#)⁷⁶⁷.
- The new [Altova SchemaManager](#)³⁰⁷ component enables you to install commonly used DTDs and XML Schemas and integrate them for use with XMLSpy and other Altova products. You can access the Schema Manager dialog via the menu command [Tools | XML Schema Manager](#)¹⁰²².
- You can now choose Microsoft Edge WebView2 as the [browser to be used in Browser View](#)¹⁰⁵⁵. This is the newer alternative to using Internet Explorer as the browser engine in [Browser View](#)²⁷⁶.
- If you are using the newer Microsoft Edge WebView2 browser engine for [Browser View](#)²⁷⁶, then you can use the browser engine's [developer tools](#)²⁷⁶ to debug and test your HTML code.
- The [HTTP Output Window](#)¹¹⁶ has been enhanced with a [log pane](#)⁵⁸³ and [information about proxy settings](#)⁵⁸⁴.
- [Database support](#)⁶⁹⁵ has been extended to: SQLite 3.38.5.
- [Eclipse support](#)⁷⁷² has been updated to cover the following versions: 2022-09; 2022-06; 2022-03; 2021-12.

1.1.2 Version 2022

Version 2022r2

- An application-wide setting enables the [pretty-printing of XML and JSON documents](#)¹⁰⁴⁸ to be switched on automatically when these are loaded in Text View.
- In the [Options dialog](#)¹⁰⁴³, you can specify the default treatment of files when they are opened in XMLSpy. This treatment will apply to files which have an extension that is not among those for which treatment has been defined.
- When generating sample XML documents from a schema, you can [specify the nesting level up to which non-mandatory elements will be generated](#)⁸⁷⁹.
- [Conversion of an XML Schema to a JSON Schema](#)⁹⁸⁷ now supports the definition of types within a JSON object. This is an alternative to defining the type by referencing it.
- Images that are stored as Base64-encoded strings in [XML](#)²⁸² and [JSON](#)⁵⁰⁷ documents can be saved as images. This feature is available in both the Text View (see [for XML](#)²⁸⁷, [for JSON](#)⁵¹⁵) and Grid View (see [for XML](#)¹⁸⁷, [for JSON](#)¹⁸⁷) of these documents.
- The [Project Window](#)¹¹⁰ now has a toolbar to quickly access frequently used project commands.
- When you hover over an image file that has been placed in a project folder (of the Project Window), a preview of the image is displayed.
- [Eclipse support](#)⁷⁷² has been updated to the most recent versions: 2021-12, 2021-09; 2021-06; 2021-03.
- [Visual Studio support](#)⁷⁶⁷ has been extended to version 2022 (64-bit).

- [Database support](#)⁶⁹⁵ has been extended to: PostgreSQL 14.1, SQLite 3.37.2, MariaDB 10.6.5, MySQL 8.0.28.

Version 2022

- Support for [BSON schema editing](#)⁵⁵⁰.
- For JSON Schemas of version draft-2019-09 and later, a schema component can both reference another schema definition as well as contain its own local definitions. This is different than it was in earlier definitions, where either a reference or local definitions were allowed, but not both. [JSON Schema View](#)⁵²³ has been updated for handling such [extended references](#)⁵³⁰.
- [Whitespace handling](#)²⁹⁶ has been improved.
- [Grid View](#)¹⁴⁶ has been enhanced so that when you scroll down a document, a header bar is displayed that will contain ancestor nodes of the node currently displayed at the top of Grid View.
- [Limits for the number of validation messages](#)¹⁰⁵³ to display can be set separately for errors, warnings, and XBRL inconsistencies.
- [Exit mode options](#)¹⁰⁴¹ enable you to choose how unsaved changes and open documents are handled when XMLSpy exits.
- In the XPath/XQuery Window, you can [load/save XPath/XQuery snippets](#)⁴³⁶ from/to an XQuery file. This provides flexibility in reusing XPath/XQuery expressions and snippets.
- New [Altova extension functions to access schema information](#)¹⁵⁹³: [Unix Time \(or Epoch Time\) functions](#)¹⁵⁷³.
- [Database support](#)⁶⁹⁵ has been extended to: PostgreSQL 13, IBM DB2 11.5, and MySQL 8.0.25.
- [Eclipse support](#)⁷⁷² has been updated so that it now covers the following versions: 2021-09; 2021-06; 2021-03; 2020-12.

1.1.3 Version 2021

Version 2021r3

- Support for [JSON Schemas](#)⁵¹² has been extended to versions 2020-12 and 2019-09.
- [Eclipse support](#)⁷⁷² has been extended so that it now covers the following versions: 2021-03, 2020-12; 2020-09; 2020-06.
- The Grid View of [XML documents](#) and [JSON documents](#) has been enhanced and improved.

Version 2021r2

- The [Grid View of XML documents](#)²⁹⁰ has been enhanced with a number of new features.
- Commands and settings related to [the Grid View of XML documents](#)²⁹⁰ have also been reorganized for ease of use: see [Grid View Settings](#)¹⁹² and the [Options dialog](#)¹⁰⁴⁸.
- Settings of the [Grid View of JSON documents](#)⁵²⁰ have been reorganized for ease of use: see [Grid View Settings](#)¹⁹² and the [Options dialog](#)¹⁰⁴⁸.
- The [Grid View of DTD documents](#)³²³ has been enhanced with new features.
- The new drag overlay feature in [XML Grid View](#)¹⁷² and [JSON Grid View](#)¹⁷⁴ provides valuable information that facilitates the use of drag-and-drop in Grid View.
- New functionality to easily and quickly add [XML fragments](#)²⁹⁸ and [JSON fragments](#)⁶⁶³ from external sources.

- In Grid View, additional components (such as XML comments) can be given [component-specific formatting](#)¹⁰⁶³. Each component type will then be displayed in Grid View with the formatting assigned to it. So, comments, for example, can be displayed with a yellow highlight in Grid View.
- A new feature to [validate documents as you edit](#)⁸⁶³ can be toggled on/off.
- [Eclipse support](#)⁷⁷² has been extended so that it now covers the following versions: 2020-12; 2020-09; 2020-06; 2020-03.

Version 2021

- The [JSON menu](#)⁸⁶⁴ offers the following JSON Grid View enhancements: select a Grid View component and insert an item before or after it; move the selected Grid View component up/down or left/right; remove all comment from the document.
- New JSON Grid View features: (i) the [context menu](#)¹⁸⁹ has been simplified; (ii) the [grid can be zoomed](#)¹⁴⁷; (iii) multiple sibling components can be [expanded/collapsed together](#)¹⁴⁷; (iv) cells containing strings can have their reading direction set to right-to-left (useful for languages with this reading direction, such as Arabic and Hebrew); the [Copy command](#)¹⁸⁹ has been enhanced.
- [JSON Schema Validation](#)⁵²³ takes the `$id` property into consideration.
- New [Altova extension functions to access schema information](#)¹⁵⁹³
- [Eclipse support](#)⁷⁷² has been extended so that it now covers: 2020.06; 2020.03; 2019.12; 2019.09.

1.1.4 Version 2020

Version 2020 Release 2

- Files that are being edited are [backed up automatically and can be restored](#)¹²⁸ in case of an unexpected program termination. You can [set whether to run automatic backups](#)¹⁰⁴¹ and with what frequency.
- The [Validate on Edit](#)²⁹⁴ feature flags validation and well-formed errors as you type in [Text View](#)²⁹⁴ and [JSON Grid View](#)¹⁵⁶. This feature can be switched on/off in the [program options](#)¹⁰⁴¹, as well as via a toolbar icon.
- In [Schema View](#)¹⁹⁸, the [Go to Type Definition](#)²²⁴ command in various context menus enables you to jump to a component's type definition (simple or complex).
- New JSON Grid View options enable you: (i) to determine whether [filters and formulas](#)¹⁸⁴ are saved to an application-wide JSON metadata file automatically, on request, or never, and (ii) to specify the location of this JSON metadata file. The metadata file can be used subsequently to apply the stored filters and formulas on the associated JSON files across multiple instances of XMLSpy, thus providing portability of filters and formulas. (*Note: Removed in version 2021r2.*)
- [JSON Grid View](#)¹⁸⁹: The context menu provides commands (i) to collapse all unselected components, and (ii) to remove all comments from the document including, optionally, formulas (which are stored as comments).
- [JSON Grid View](#)⁵²⁰: Improved Find functionality.

Version 2020

- [JSON Grid View](#)⁵²⁰ provides additional editing features: (i) automatic type detection, (ii) in-cell commands, (iii) XQuery filters for modifying the view, and (iv) XQuery formulas for generating additional output from JSON data.

- Validation and editing support for [JSON Lines and JSON Comments](#) ⁵¹⁴.
- In JSON Grid View [images can be displayed](#) ¹⁸⁷.
- The [Options dialog](#) ¹⁰⁴⁰ (**Tools | Options**) provides settings for JSON Grid View and for pretty-printing JSON documents in Text View. (*Note: Moved to the Grid View Settings dialog and the Pretty Printing section of the Options dialog.*)
- The Evaluator and Expression Builder of the [XPath/XQuery Window](#) ⁴¹⁹ have been re-designed for ease of use.
- The [XPath Debugger](#) ⁴²⁸ functionality of the [XPath/XQuery Window](#) ¹¹⁵ has been enhanced with a number of new features: (i) Watch expressions, (ii) improved interface for better overview, and (iii) more powerful analytics. As a result of these new features, it is even easier for you to test and debug XPath/XQuery expressions against XML and JSON files.
- Previously, the default editing view of files with different filetypes was selected in the [Options dialog](#) ¹⁰⁴³. The default editing view can now, additionally, be [chosen directly in the editing view itself](#) ¹²⁶.
- Support for the integration of XMLSpy in [Visual Studio](#) ⁷⁶⁷ has been extended to Visual Studio 2019.
- Support for the integration of XMLSpy in [Eclipse](#) ⁷⁷² has been extended to Eclipse 4.11 and 4.12.

1.2 Windows File Paths

File paths in Windows

File paths given in this documentation will not be the same for all operating systems. You should note the following correspondences:

- (My) Documents folder: Located by default at the following locations. Example files are located in a sub-folder of this folder.

Windows 7/8/10/11	C:\Users\ <username>\Documents</username>
-------------------	---

- *Application folder*: The Application folder is the folder where your Altova application is located. The path to the Application folder is, by default, the following.

Windows 7/8/10/11	C:\Program Files\Altova\
32-bit version on 64-bit OS	C:\Program Files (x86)\Altova\

Note: XMLSpy is also supported on Windows Server 2016 or newer.

1.3 About RaptorXML Server

Altova RaptorXML(+XBRL) Server (also called Raptor or RaptorXML for short) is Altova's third-generation, hyper-fast XML (and XBRL) processor. It has been built to optimally utilize the latest standards and parallel computing environments. It can be used on multiple platforms, and takes advantage of today's ubiquitous multi-core computers to deliver lightning fast processing of XML and XBRL data.

RaptorXML is available in two editions:

- RaptorXML Server, which can be accessed over a network and can transform multiple files at a time.
- RaptorXML+XBRL Server edition, which can be accessed over a network, can transform multiple files at a time, and additionally supports XBRL validation.

RaptorXML can be run from the command line and has interfaces for COM, Java, .NET, and Python. A Raptor server can also be run [from within the XMLSpy interface](#)⁷²¹.

Altova website: [XML validation server](#), [XML validator](#)

2 XMLSpy Tutorial

This tutorial provides an overview of XML and takes you through a number of key XML tasks. In the process you will learn how to use some of XMLSpy's most powerful features.

The tutorial is divided into the following parts:

- [XMLSpy Interface](#)³¹, which helps you to familiarize yourself with the applications's graphical user interface (GUI).
- [Creating an XML Schema](#)⁴². You will learn how to create an XML Schema in XMLSpy's intuitive Schema View, how to create complex content models using drag-and-drop mechanisms, and how to configure Schema View.
- [Using Schema View features](#)⁵⁷ to create complex and simple types, global element references, and attribute enumerations.
- Learning how to [navigate schemas](#)⁷⁰ in Schema View, and how to [generate documentation of schemas](#)⁷⁰.
- [Creating an XML document](#)⁷⁷. You will learn how to assign a schema for an XML document, edit an XML document in Grid View and Text View, and validate XML documents using XMLSpy's built-in validator.
- [Transforming an XML file using an XSLT stylesheet](#)⁹⁸. This involves assigning an XSLT file and carrying out the transformation using XMLSpy's built-in XSLT engines.
- [Working with XMLSpy projects](#)¹⁰², which enable you to easily organize your XML documents.

Installation and configuration

This tutorial assumes that you have successfully installed XMLSpy on your computer and received a free evaluation key-code, or are a registered user. The evaluation version of XMLSpy is fully functional but limited to a 30-day period. You can request a regular license from our secure web server or through any one of our resellers.

Tutorial example files

The tutorial files are available in the application folder:

```
C:\Documents and Settings\\My Documents\Altova\XMLSpy2024\Examples\Tutorial
```

The `Examples` folder contains various XML files for you to experiment with, while the `Tutorial` folder contains all the files used in this tutorial.

The `Template` folder in the application folder (typically in `C:\Program Files\Altova`) contains all the XML template files that are used whenever you select the menu option **File | New**. These files supply the necessary data (namespaces and XML declarations) for you to start working with the respective XML document immediately.

2.1 XMLSpy Interface

In this section of the tutorial, you will start XMLSpy and get to know the interface.

Starting XMLSpy

To start XMLSpy, double-click the XMLSpy icon on your desktop or use the **Start | All Programs** menu to access the XMLSpy program. XMLSpy is started with no documents open in the interface. Open XMLSpy now.

Overview of the interface

The default view of the XMLSpy interface is structured into three vertical areas (*figure below*). These three areas contain, from left to right: (i) the Project and Info windows; (ii) the Main and Output windows; and (iii) the Entry Helper windows. Look at the Project window. It will contain the Examples project, which is opened by default when you start XMLSpy for the first time.

Given below are key points that will help you to understand the layout of the interface and the functions of its various components. The sub-sections of this first part of the tutorial will help you get familiar with the interface.

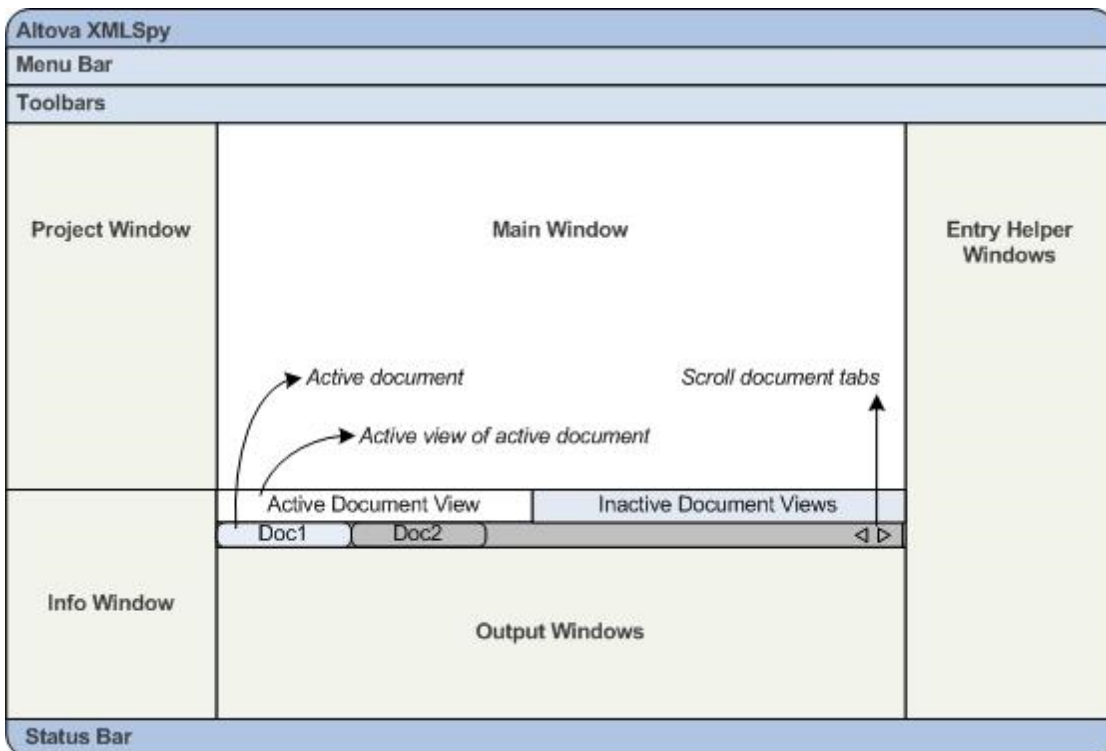

Document bar in the Main window: When multiple documents are open, each document is displayed in a tab in the document bar of the Main window (*see figure*). Clicking a tab makes that document the active document. You can scroll document tabs by clicking the arrows on the right hand side of the document bar. Open two or more files (for example, from the Examples project), and check how the tabs work.

Document editing views: The active document can be viewed in one of multiple applicable editing views. For example:

- An XML (.xml) document can be viewed in Text View, Grid View, Authentic View, and Browser View, but cannot be viewed in other views, such as Schema View.
- An XML Schema (.xsd) document, on the other hand can be viewed in Text View, Grid View, Schema View, and Browser View, but not in Authentic View.

The following views are available: [Text View](#)¹³⁰, [Grid View](#)¹⁴⁶, [Schema View](#)¹⁹⁸, [Authentic View](#)⁴⁵⁹, [Archive View](#)⁵⁹⁵, and [Browser View](#)²⁷⁶.

Entry helpers: The entry helper windows change according to the kind of the active document (for example, XML or XSD or CSS or WSDL) and according to the currently active document view (for example, Text View or Schema View). The entry helpers enable you to quickly and correctly edit the active document by providing context-sensitive editing support.

2.1.1 The Views

In this part of the tutorial you will learn: (i) to switch between document editing views, and (ii) to change the default editing view of a particular document type.

Switching between document views

When you open a document it will open in the view that has been set as the default view for that type of document. Open a document as follows:

1. Click the command **File | Open**.
2. Browse for the file `AddressFirst.xsd`, which is located in the `C:\Documents and Settings\<username>\My Documents\Altova\XMLSpy2024\Examples\Tutorial` folder, select it, and click **Open**. The file opens in Schema View.
3. Switch among the various views by clicking the view tabs at the bottom of the Main window (Text View, Grid View, etc). You will be able to view the XML Schema document in Text View, Grid View, Schema View, and Browser View.
4. You can also change views by selecting the view you want from the options in the **View** menu. Try switching the view of the `AddressFirst.xsd` document using the **View** menu commands.
5. Close the document (via **File | Close**).

Changing the default view of a document type

All documents with the `.xsd` extension will open by default in Schema View. You can change the default opening view of any type of document in the Options dialog. Let us do this for `.xsd` documents now.

1. Click the command **Tools | Options** and go to the *File Types* section (*screenshot below; note that some options, such as those related to XBRL and Avro support, are available in Enterprise Edition only*).
2. In the *File Types* pane, scroll down to `.xsd` and select it (*highlighted in screenshot*).
3. In the *Default View* pane, select Text View.

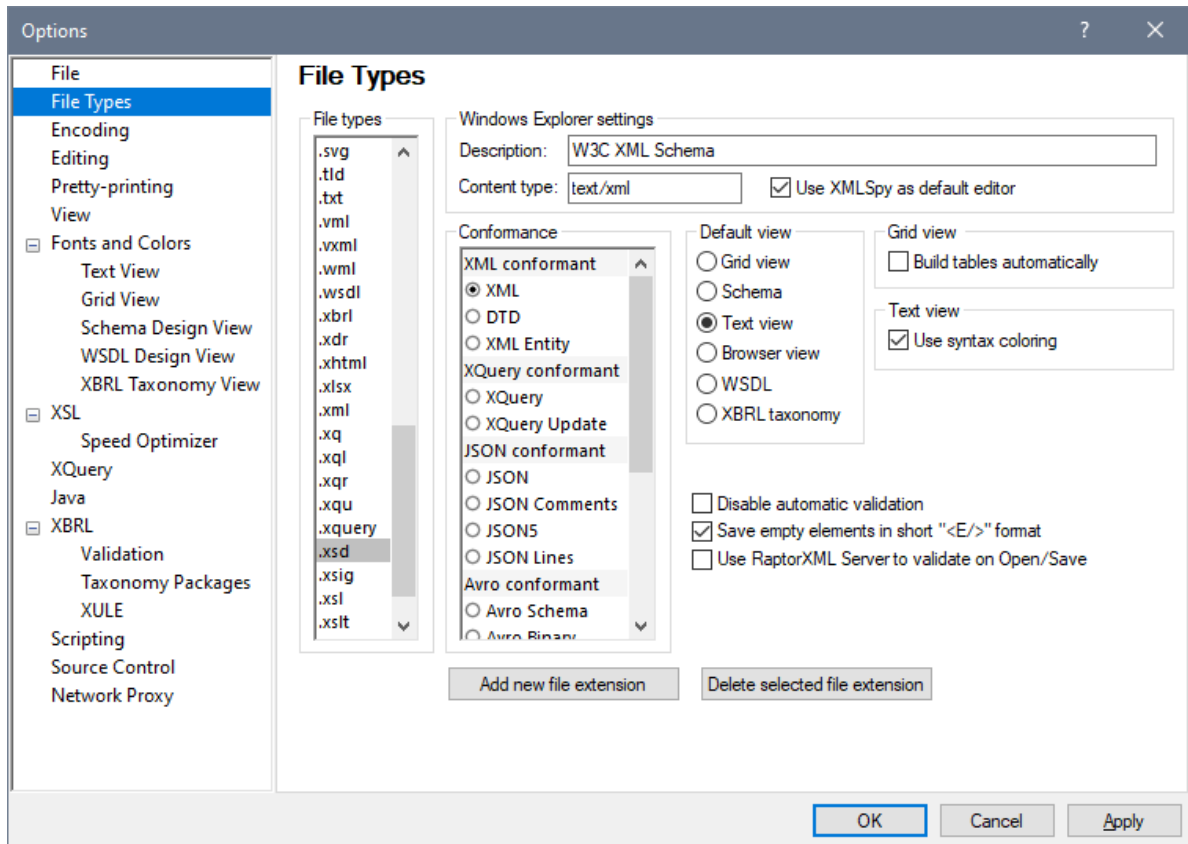

4. Click **OK**.
5. Click the **File | Open** command, and open the file `AddressFirst.xsd`. The file opens in Text View.
6. Switch to Schema View to see the file in this view, then close the file (**File | Close**).
7. Go back to the Options dialog (**Tools | Options**), and, in the *File Types* section, change the default view of `.xsd` files back to Schema View.

Note: In the *File Types* section of the Options dialog (screenshot above), you can change the default view of any of the listed file extensions. A new file extension can be added to the list via the **Add New File Extension** button.

2.1.2 The Windows

By default, the various windows are located around the Main window (see screenshot below) and are organized into the following window groups:

- Project window
- Info window
- Entry helpers (various, depending on the type of document currently active)
- Output windows: Messages, XPath, XSL Outline, Find in Files, Find in Schemas

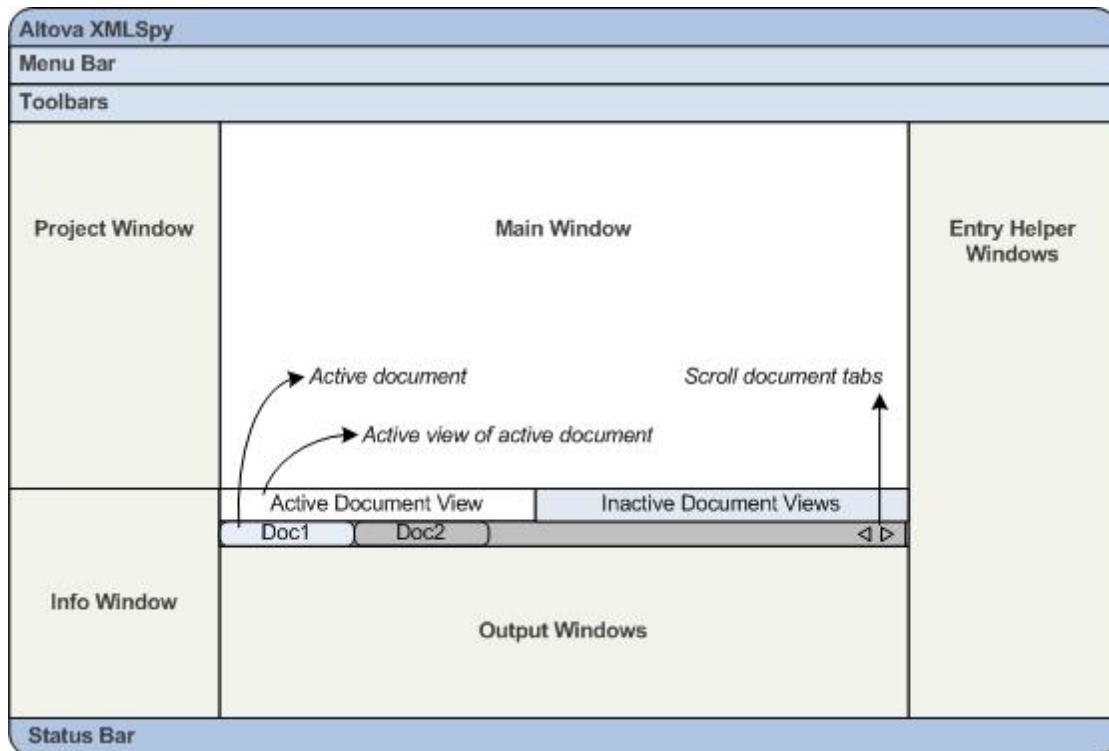

In this section, you will learn how to turn on and off the display of window groups and how to move windows around the screen. Being able to manage the display of windows well will be useful when you need more space within the interface.

Switching the display of window groups on and off

Window groups (Project Window, Info Window, Entry Helpers, Output Windows) can be displayed or hidden by toggling them on and off via the commands in the **Window** menu. A displayed window group can also be hidden by right-clicking its title bar and selecting the command **Hide**. A hidden window can only be displayed via the **Window** menu.

Open any XML file in the `c:\Documents and Settings\\My Documents\Altova\XMLSpy2024\Examples\Tutorial1` folder, and practise using these basic commands till you are familiar with the way the commands work. For more information about displaying and hiding window groups, see the section, [XMLSpy Interface](#)¹⁰⁷.

Saved status and backup status

By default, XMLSpy backs up unsaved documents at intervals of five seconds. Each file's tab at the bottom of the Main Window provides information via indicator symbols about the file's saved/unsaved status and its backup status. You should be aware of the meanings of these indicators since you will come across them constantly during your work. See the [Automatic Backup of Files](#)¹²⁸ section for information about these indicators.

Moving windows around the screen

An individual window can either float free of the interface or be docked within it. A window can also be docked as a tab within a window group (*window groups are explained above*). For example, the screenshot below shows the Components entry helper in Schema View, which has three tabbed windows: the Globals window, Namespaces window, and Identity Constraints window.

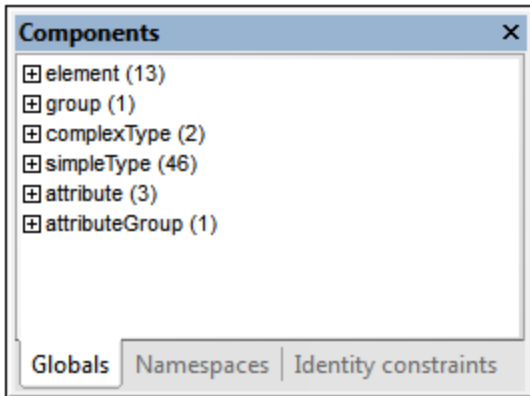

A window can be made to float or dock using one of the following methods in any view:

- Double-click the title bar of the window. If docked, the window will now float. If floating, the window will now dock in the last position in which it was docked.
- Right-click the title bar of a window and choose the required command (**Floating** or **Docking**).
- Drag the window (using its title bar as a handle) out of its docked position so that it floats. Drag a floating window (by its title bar) to the location where it is to be docked. Two sets of blue arrows appear. The outer set of four arrows enables docking relative to the application window (along the top, right, bottom, or left edge of the GUI). The inner set of arrows enables docking relative to the window over which the cursor is currently placed. Dropping a dragged window on the button in the center of the inner set of arrows (or on the title bar of a window) docks the dragged window as a tabbed window within the window in which it is dropped.

To float a tabbed window, double-click its tab. To drag a tabbed window out of a group of tabbed windows, drag its tab.

To practise moving windows around open any XML Schema file from the `c:\Documents and Settings\\My Documents\Altova\XMLSpy2024\Examples\Tutorial` folder, and, while in Schema View, try the methods described above till you are able to move windows around the interface comfortably.

2.1.3 Menus and Toolbars

In this section of the tutorial, you will quickly learn about the main features of the menus and toolbars of XMLSpy.

Menus

There are two menu bars: (i) a default menu that is displayed when no document is open, and (ii) the full XMLSpy application menu, which is displayed as soon as a document is open. Do the following:

1. Close all open documents with the menu command **File | Close All**. You will see the default menu.
2. Open the `AddressFirst.xsd` file by clicking its name from the list of most recently opened files located at the bottom of the **File** menu. When the file opens in Schema View, the menu will change to the full XMLSpy application menu.

The menus are organized primarily according to function, and a command in a menu is enabled only when it can be executed at the cursor point or for a selection in the current view of the active document. Do the following to understand the factors that determine whether a menu command is enabled or disabled:

1. Click the **Schema Design** menu. Notice that the **Save Diagram**, **Configure View**, and **Zoom** commands are disabled (*screenshot below*).

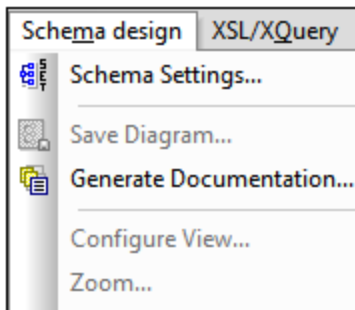

2. Click in a blank space outside the menu to make the menu disappear. Then click the **Display Diagram** icon  located to the left of the element component. This takes you to the Content Model View of Schema View (the second of Schema View's two views; the first is Schema Overview). If you check the Schema Design menu now, you will see that the **Save Diagram**, **Configure View**, and **Zoom** commands have been enabled. They are enabled only in the Content Model View of Schema View, not in the Schema Overview of Schema View, nor in any other view. Note also that only XML Schema files can be opened in Schema View.
3. An XML Schema file is also an XML file, so it is displayed as an XML file in Text View and Grid View, and all menu commands that apply to XML files will be enabled in these views. Compare commands in the **Edit** menu (whether they are enabled or not) in Schema View and Text View.
4. Next compare commands in the **XML | Insert** menu (enabled or disabled) in Text View and Grid View. The commands in this menu are enabled only in Grid View.

For descriptions of all the menu commands, see the [User Reference section](#) ⁷⁸¹ of the user documentation.

Toolbars

The display of toolbars varies according to the current view. The application's default settings provide the correct toolbars for each view and will be different for each view. However, you can customize toolbars in the *Toolbars* tab of the Customize dialog (**Tools | Customize | Toolbars**, *screenshot below*).

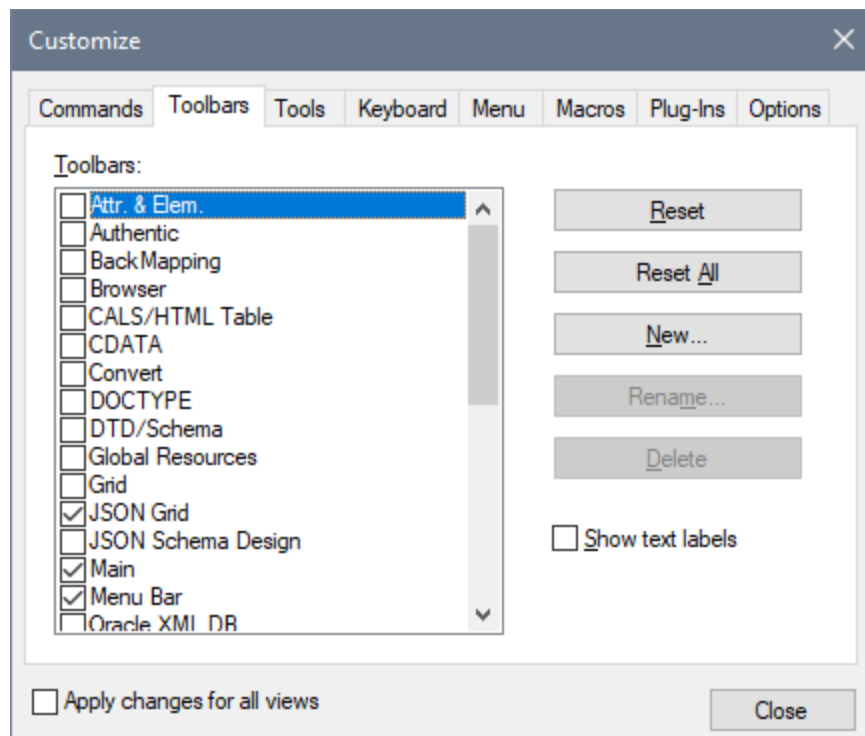

Now practise moving toolbars around the GUI. Click the handle of a toolbar and drag the toolbar to any desired location in the GUI. (The toolbar handle is indicated by the dotted vertical line at the left of each toolbar; see *screenshot below*.)



Try dragging a toolbar to the following locations: (i) another line in the toolbar area; (ii) left or right of another toolbar; (iii) the middle of the Main window; (iv) docked to the left or right side of the application window (for this to happen, the grab handle must be placed above the left or right border of the application window).

After you have finished, close the file `AddressFirst.xsd`.

2.1.4 Text View Settings

In this section, you will learn how to set up a "pretty-printed" document and how to use bookmarks while editing. When a document is pretty-printed it is displayed in Text View so that each lower level in the XML hierarchy is indented deeper than the previous level (see *screenshot below*). Bookmarks enable you to mark document positions that you wish to return to quickly.

```
1 <?xml version="1.0" encoding="UTF-8"?>
2 <Company>
3   <Address xsi:type="US-Address">
4     <Name>US dependency</Name>
5     <Street>Noble Ave.</Street>
6     <City>Dallas</City>
7     <Zip>04812</Zip>
8     <State>Texas</State>
9   </Address>
10  <Person Manager="true" Degree="BA" Programmer="false">
11    <First>Fred</First>
12    <Last>Smith</Last>
13    <PhoneExt>22</PhoneExt>
14    <Email>Smith@work.com</Email>
15  </Person>
16 </Company>
```

Pretty-printing

Pretty-printing involves two steps: (i) setting up pretty-printing, (ii) applying pretty-printing.

1. Open the file `CompanyFirst.xml`, which is in the `c:\Documents and Settings\<username>\My Documents\Altova\XMLSpy2024\Examples\Tutorial` folder.
2. Switch to Text View if Text View is not the default starting view of XML documents.
3. Select the menu command **View | Text View Settings** to open the Text View Settings dialog (*screenshot below*).

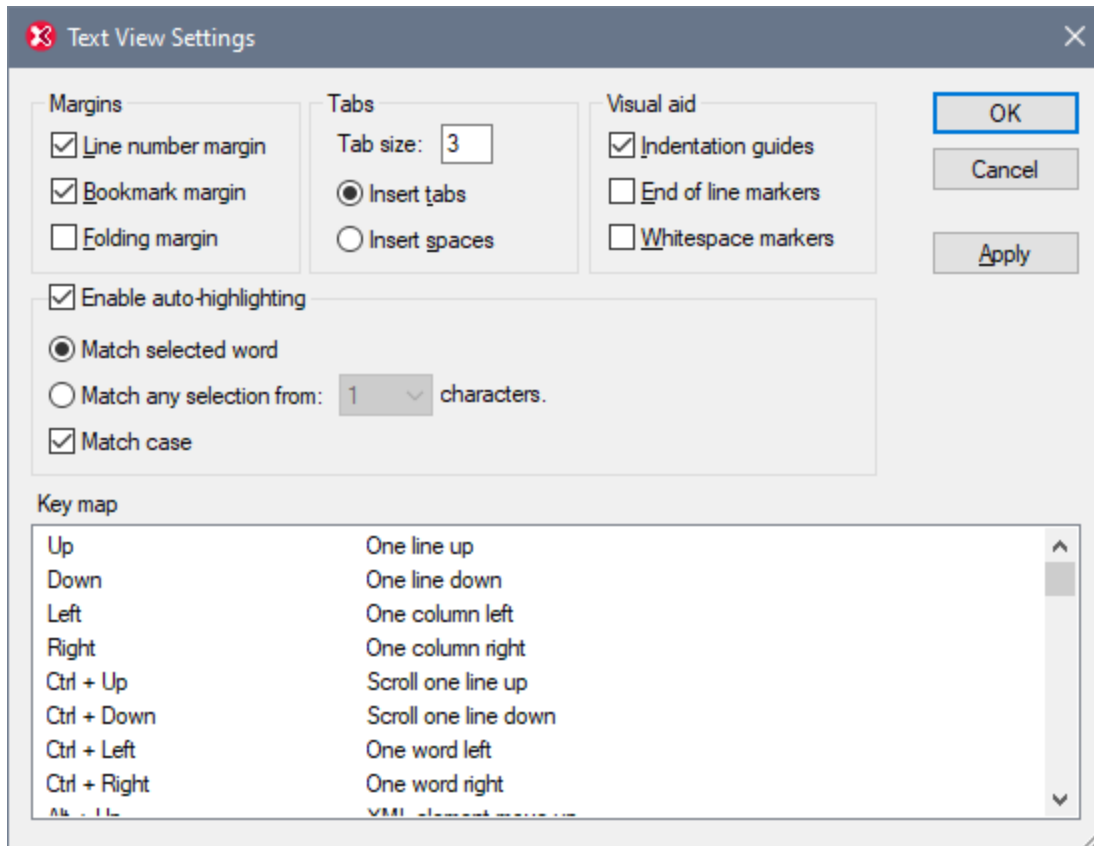

4. In the Tabs pane, decrease the Tab size to 3. Leave the default selection of the *Insert Tabs* radio button as it is. This will cause the [pretty-printing indent](#)¹³¹ to be a tab (rather than spaces) and each tab will have a width of three spaces. Click **OK** when done.
5. Click the menu command **Edit | Pretty-Print**. This applies pretty printing. The document display will be reset with the new tab values.
6. Open the Text View Settings dialog again (**View | Text View Settings**) and, in the *Visual Aid* pane, switch on the end-of-line markers.
7. In Text View, go to the end of any line and delete the end-of-line marker so that the next line jumps up a line.
8. Switch to Grid View and back again to Text View.
9. Click the menu command **Edit | Pretty-Print**. The document will be pretty-printed, and the the end-of-line marker you deleted will be reinstated.

Note: If, in the Pretty-printing section of the Options dialog ([Tools | Options | Pretty-printing](#)¹⁰⁴⁸), you uncheck the *Use Indentations* check box and pretty-print, then all lines will begin without any indentation.

Bookmarking

Bookmarks are placed in a bookmark margin on the left of lines you wish to mark. You can then quickly move up and down through the bookmarks in your document.

1. In the Text View Settings dialog (**View | Text View Settings**, *screenshot above*) ensure that the Bookmarks Margin option in the *Margins* pane is selected. Click **OK** when done.

2. In Text View of the file `CompanyFirst.xml`, place the cursor anywhere in a line you wish to bookmark, then select the menu command **Edit | Insert/Remove Bookmark**. The line will be bookmarked and indicated by a blue bookmark in the bookmark margin (see *screenshot below*).
3. Create a bookmark on another line in the same way as in Step 2.

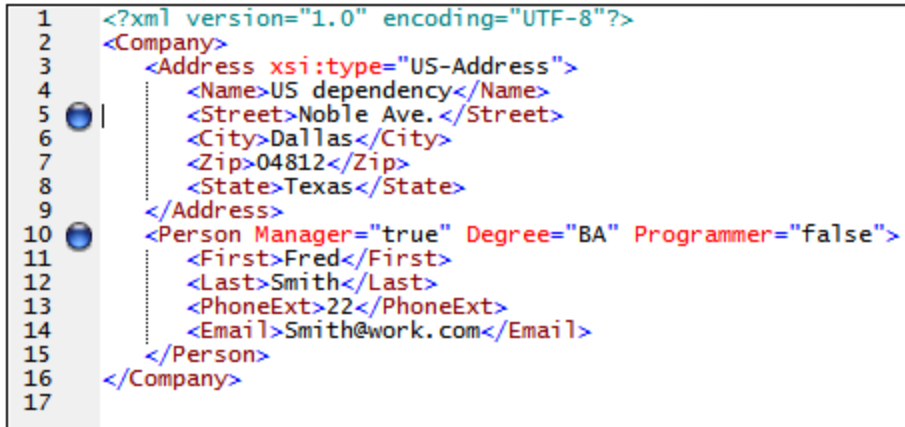

```
1 <?xml version="1.0" encoding="UTF-8"?>
2 <Company>
3   <Address xsi:type="US-Address">
4     <Name>US dependency</Name>
5     <Street>Noble Ave.</Street>
6     <City>Dallas</City>
7     <Zip>04812</Zip>
8     <State>Texas</State>
9   </Address>
10  <Person Manager="true" Degree="BA" Programmer="false">
11    <First>Fred</First>
12    <Last>Smith</Last>
13    <PhoneExt>22</PhoneExt>
14    <Email>Smith@work.com</Email>
15  </Person>
16 </Company>
17
```

4. Press **F2** (or the command **Edit | Go to Next Bookmark**) to go down the document to the next bookmark. Press **Shift+F2** (or the command **Edit | Go to Previous Bookmark**) to go up the document to the previous bookmark. Repeat either or both commands as many times as you like.
5. Place the cursor in one of the bookmarked lines and select the menu command **Edit | Insert/Remove Bookmark**. The bookmark is removed.
6. Save and close the file. No bookmark information is saved with the file. Reopen the file to check this.

2.1.5 Application Options

Because XMLSpy is so densely packed with features, there are a number of options that you can set and which can significantly affect various aspects of your work. So it would be very beneficial for you in the long term to be aware of the application settings that you can change to suit your work requirements and working style. These settings are accessed in the Options dialog (*screenshot below*), which you open via the menu command **Tools | Options** ¹⁰⁴⁰.

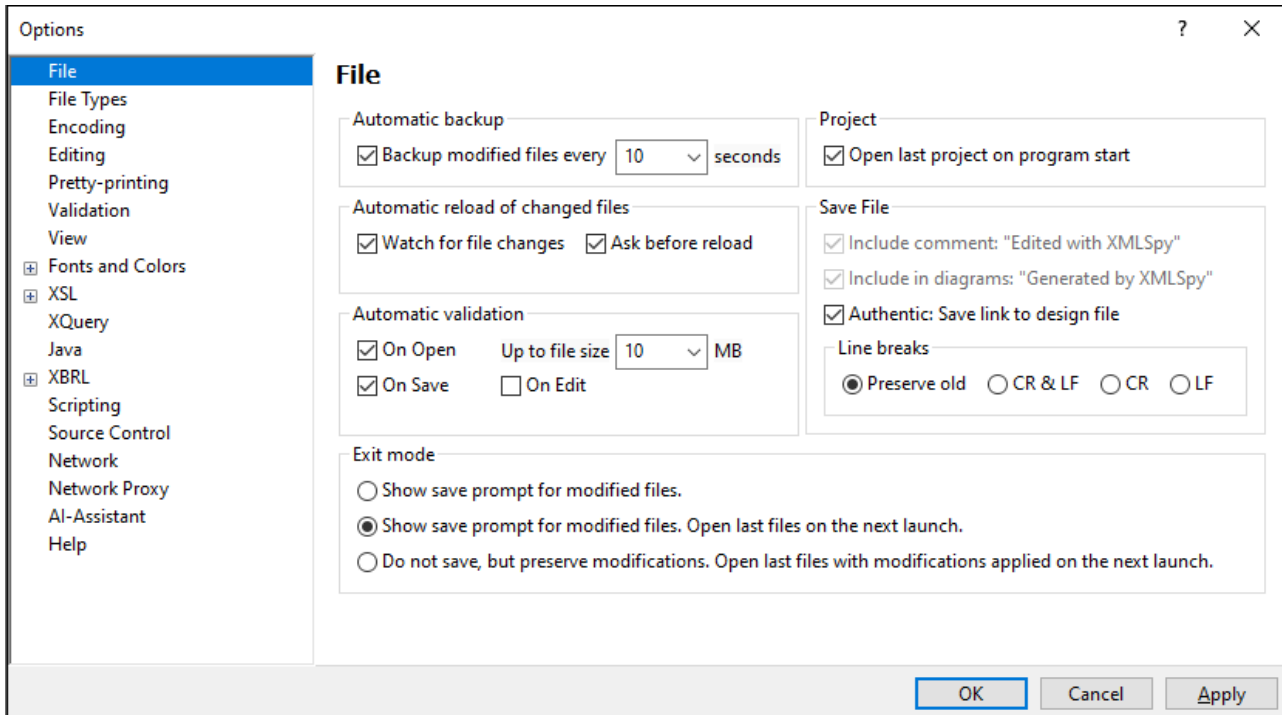

The settings are organized in sections, listed in the left-hand pane. *Note that XBRL options are available in the Enterprise Edition only.* We suggest you look through each section to get an idea of what settings are available. In the list below, we have drawn attention to settings that affect some commonly used features. For descriptions of all settings, go to the [documentation of the Options dialog](#)¹⁰⁴⁰. After you change a setting, click **OK** to save the change to the registry and to close the dialog. The **Apply** button causes changes to be displayed in currently open documents.

File

Automatic backup (of files you are editing) can be switched on/off. *Validate on on Edit* performs well-formed checks and validation checks as you type. If this disturbs you, you can switch off this feature, and perform well-formed checks and validation checks when you are ready.

File types

Set the default view by file type. You can select the view you are most comfortable with for each type of document.

View

In the XMLSpy title bar, show either just the file name or the entire file path. Note that you can see the file path if you hover over the file's name in the file tab at the bottom of the Main Window.

Fonts and Colors

You can set up the fonts, their sizes, and the colors of text and other components. There are separate settings for each view.

2.2 XML Schemas: Basics

An XML Schema describes the structure of an XML document. An XML document can be validated against an XML Schema to check whether it conforms to the requirements specified in the schema. If it does, it is said to be **valid**; otherwise it is **invalid**. XML Schemas enable document designers to specify the allowed structure and content of an XML document and to check whether an XML document is valid.

The structure and syntax of an XML Schema document is complex, and being an XML document itself, an XML Schema must be valid according to the rules of the XML specification. In XMLSpy, Schema View enables you to easily build valid XML Schemas by using graphical drag-and-drop techniques. The XML Schema document you construct is also editable in Text View and Grid View, but is much easier to create and modify in Schema View.

Objective

In this section of the tutorial, you will learn how to edit XML Schemas in Schema View. Specifically, you will learn how to do the following:

- Create a new schema file
- Define namespaces for the schema
- Define a basic content model
- Add elements to the content model using context menus and drag-and-drop
- Configure the Content Model View

After you have completed creating the basic schema, you can go to the [next section of the tutorial](#)⁵⁷, which teaches you how to work with the more advanced features of XML Schema in XMLSpy. This advanced section is followed by a section about [schema navigation and documentation](#)⁷⁰ in XMLSpy.

Commands used in this section

In this section of the tutorial, you will use Schema View exclusively. The following commands are used:

	Display Diagram (or Display Content Model View). This icon is located to the left of all global components in Schema Overview. Clicking the icon causes the content model of the associated global component to be displayed.
---	---

2.2.1 Creating a New XML Schema File

To create a new XML Schema file:

1. Select the menu option **File | New**. The Create new document dialog opens.

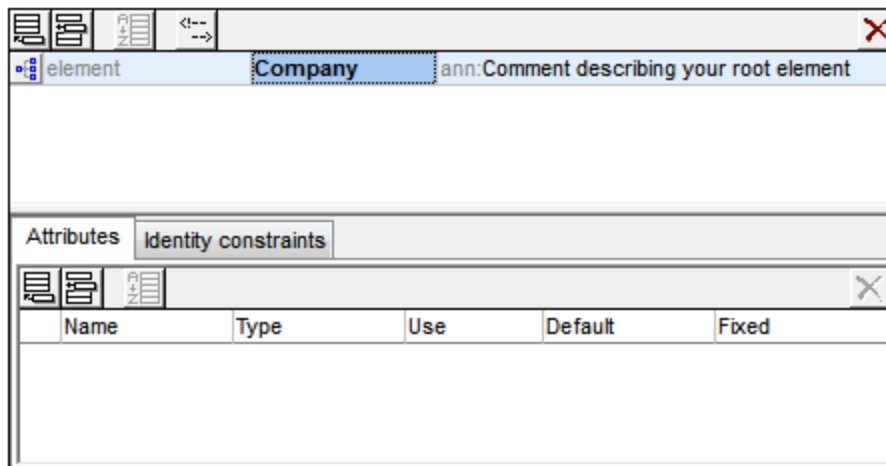

6. In the Annotations field (**ann**) of the `Company` element, enter the description of the element, in this case, *Root element*.
7. Click the menu option **File | Save**, and save your XML Schema with any name you like (`AddressFirst.xsd`, for example).

The colored-circle symbols in the file's tab indicate the file's backup status. See [Automatic Backup of Files](#)¹²⁸ for a description of these indicators.

2.2.2 Defining Namespaces

XML namespaces are an important issue in XML Schemas and XML documents. An XML Schema document must reference the XML Schema namespace and, optionally, it can define a target namespace for the XML document instance. As the schema designer, you must decide how to define both these namespaces (essentially, with what prefixes.)

In the XML Schema you are creating, you will define a target namespace for XML document instances. (The required reference to the XML Schema namespace is created automatically by XMLSpy when you create a new XML Schema document.)

To create a target namespace:

1. Select the menu option **Schema Design | Schema Settings**. This opens the Schema Settings dialog (*screenshot below*).

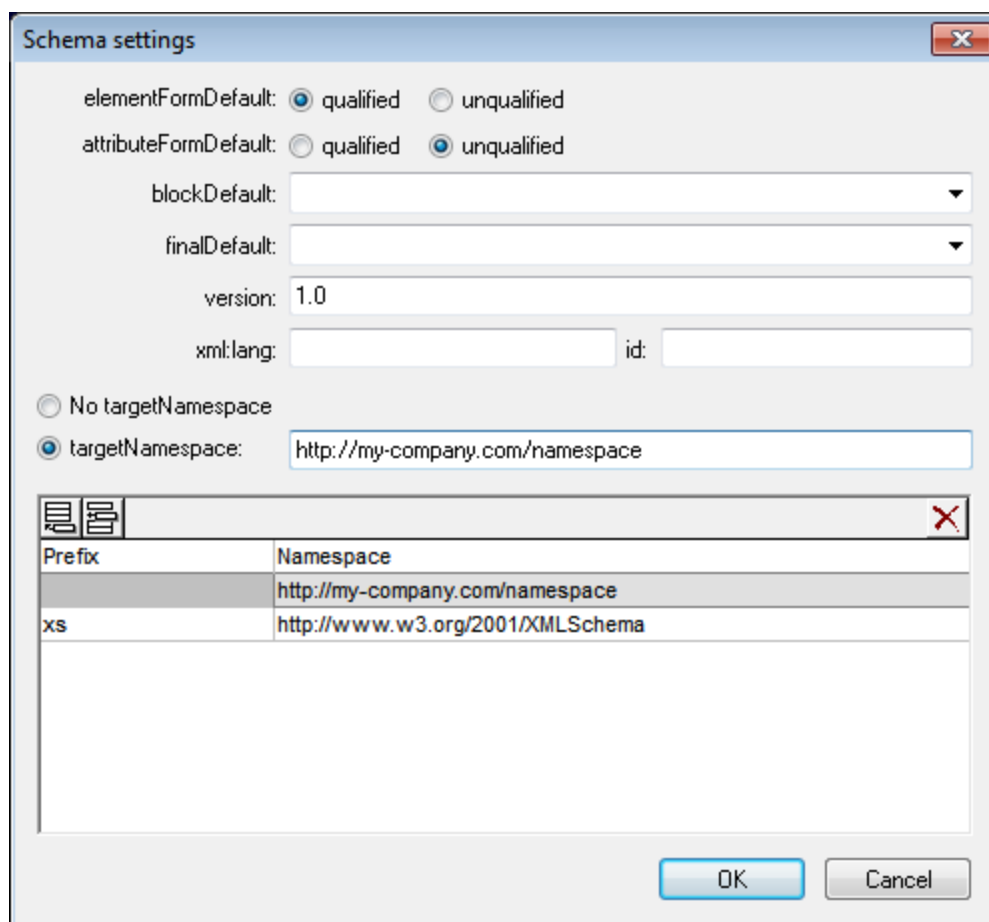

2. Click the *Target Namespace* radio button, and enter `http://my-company.com/namespace`. In XMLSpy, the namespace you enter as the target namespace is created as the default namespace of the XML Schema document and displayed in the list of namespaces in the bottom pane of the dialog.
3. Confirm with the **OK** button.

Note the following:

- The XML Schema namespace is automatically created by XMLSpy and given a prefix of `xs:`.
- When the XML document instance is created, it must have the target namespace defined in the XML Schema for the XML document to be valid.

2.2.3 Defining a Content Model

In Schema Overview, you have already created a global element called `company`. This element is to contain one `address` element and an unlimited number of `person` elements. This then is the Company element's content model. Global components that may have content models are: elements, complexTypes, and element groups. In XMLSpy, the content model of a global component is displayed in the Content Model View of Schema View.

To view and edit the content model of a global component, click the Display Diagram icon  located to the left of the global component.

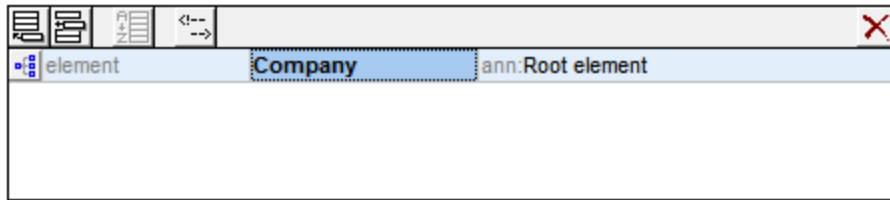

In this section, you will create the content model of the `Company` element.

Creating a basic content model

To create the content model of the `Company` element:

1. In Schema Overview, click the Display Diagram icon  of the `Company` element. This displays the content model of the `Company` element (*screenshot below*), which is currently empty. Alternatively, you can double-click the `Company` entry in the Components entry helper to display its content model.

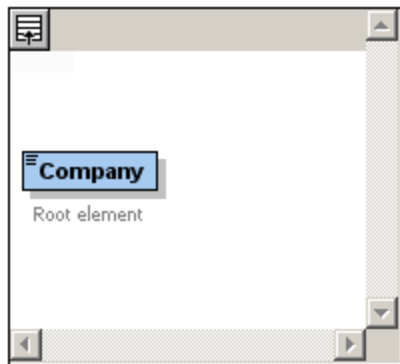

2. A content model consists of **compositors** and **components**. The compositors specify the relationship between two components. At this point of the `Company` content model, you must add a child compositor to the `Company` element in order to add a child element. To add a compositor, right-click the `Company` element. From the context menu that appears, select **Add Child | Sequence**. (Sequence, Choice, and All are the three compositors that can be used in a content model.)

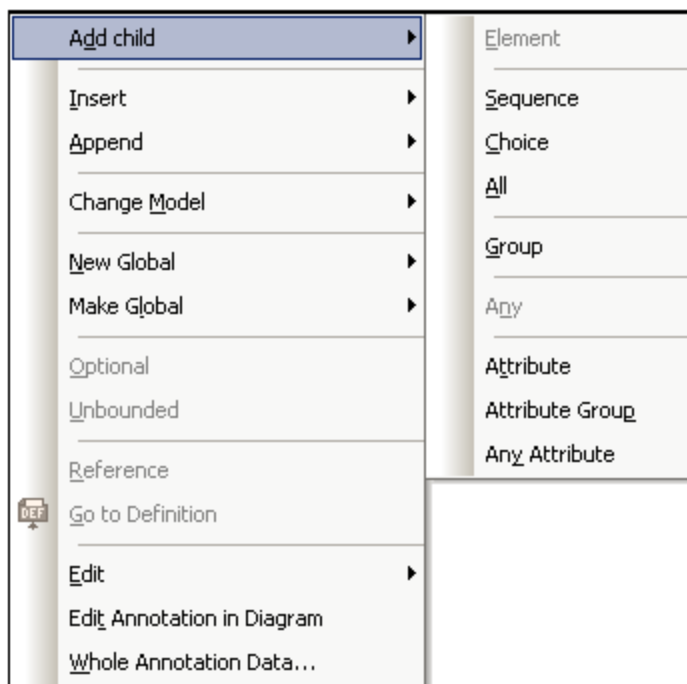

This inserts the Sequence compositor, which defines that the components that follow must appear in the specified sequence.

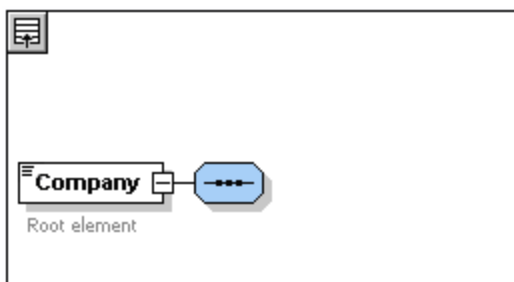

3. Right-click the Sequence compositor and select **Add Child | Element**. An unnamed element component is added.
4. Enter **Address** as the name of the element, and confirm with **Enter**.

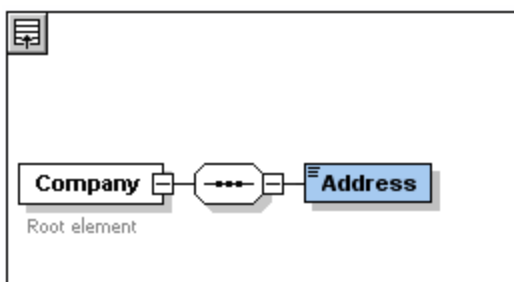

5. Right-click the Sequence compositor again, select **Add Child | Element**. Name the newly created element component *Person*.

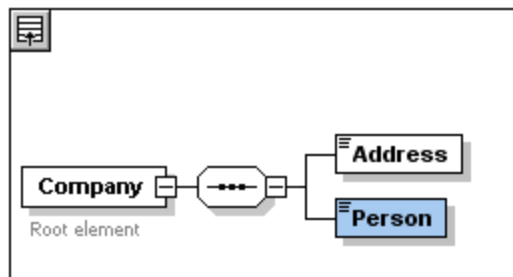

You have so far defined a schema which allows for one address and one person per company. We need to increase the number of `Person` elements.

- Right-click the `Person` element, and select **Unbounded** from the context menu. The `Person` element in the diagram now shows the number of allowed occurrences: 1 to infinity.

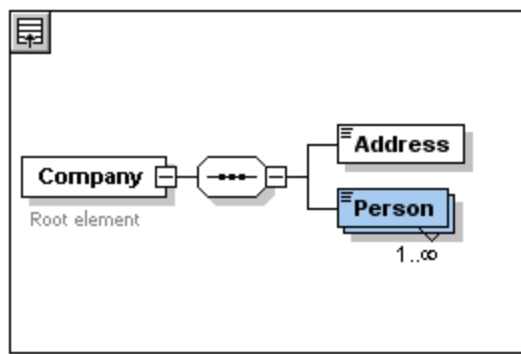

Alternatively, in the Details Entry Helper, you can edit the `minOcc` and `maxOcc` fields to specify the allowed number of occurrences, in this case 1 and unbounded, respectively.

Adding additional levels to the content model structure

The basic content model you have created so far contains one level: a child level for the `company` element which contains the `Address` and `Person` elements. Now we will define the content of the `Address` element so it contains `Name`, `Street`, and `City` elements. This is a second level. Again we need to add a child compositor to the `Address` element, and then the element components themselves.

Do this as follows:

- Right-click the `Address` element to open the context menu, and select **Add Child | Sequence**. This adds the Sequence compositor.
- Right-click the Sequence compositor, and select **Add Child | Element**. Name the newly created element component `Name`.

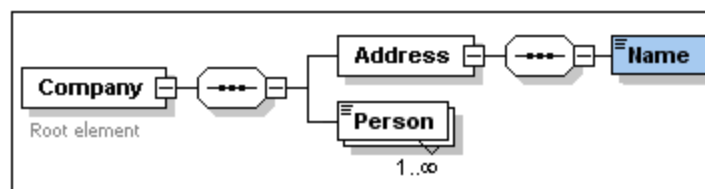

Complex types, simple types, and XML Schema data types

Till this point, we have not explicitly defined any element type. Click the **Text** tab to display the Text View of your schema (*listing below*). You will notice that whenever a Sequence compositor was inserted, the `xs:sequence` element was inserted within the `xs:complexType` element. In short, the **Company** and **Address** elements, because they contain child elements, are complex types. A complex type element is one which contains attributes or elements.

```
<xs:element name="Company">
  <xs:annotation>
    <xs:documentation>Root element</xs:documentation>
  </xs:annotation>
  <xs:complexType>
    <xs:sequence>
      <xs:element name="Address">
        <xs:complexType>
          <xs:sequence>
            <xs:element name="Name"/>
          </xs:sequence>
        </xs:complexType>
      </xs:element>
      <xs:element name="Person"/>
    </xs:sequence>
  </xs:complexType>
</xs:element>
```

Simple type elements, on the other hand, contain only text and have no attributes. Text can be strings, dates, numbers, etc. We want the **Name** child of **Address** to contain only text. It is a simple type, the text content of which we want to restrict to a string. We can do this using the XML Schema data type `xs:string`.

To define the **Name** element to be of this datatype:

1. Click the **Schema** tab to return to Schema View.
2. Click the **Name** element to select it.
3. In the Details Entry Helper, from the dropdown menu of the `type` combo box, select the `xs:string` entry.

The screenshot shows the XML Schema diagram on the left and the Details Entry Helper on the right. The diagram illustrates the following structure:

- Company** (root element) contains a sequence of **Address** and **Person**.
- Address** contains a sequence of **Name**.
- Name** is a simple type element.

The Details Entry Helper for the **Name** element shows the following properties:

Property	Value
name	Name
isRef	<input type="checkbox"/>
minOcc	1
maxOcc	1
type	xs:string
content	xs:normalizedS
derivedBy	xs:NOTATION
default	xs:positiveInte
fixed	xs:QName
nillable	xs:short
block	xs:string
form	xs:time

Note that both `minOcc` and `maxOcc` have a value of 1, showing that this element occurs only once.

The text representation of the `Name` element is as follows:

```
<xs:element name="Name" type="xs:string"/>
```

Note: A simple type element can have any one of several XML Schema data types. In all these cases, the icon indicating text-content appears in the element box.

2.2.4 Adding Elements with Drag-and-Drop

You have added elements using the context menu that appears when you right-click an element or compositor. You can also create elements using drag-and-drop, which is quicker than using menu commands. In this section, you will add more elements to the definition of the `Address` element using drag-and-drop, thus completing this definition.

To complete the definition of the `Address` element using drag-and-drop:

1. Click the `Name` element of the `Address` element, hold down the **Ctrl** key, and drag the element box with the mouse. A small "plus" icon appears in the element box, indicating that you are about to copy the element. A copy of the element together with a connector line also appears, showing where the element will be created.

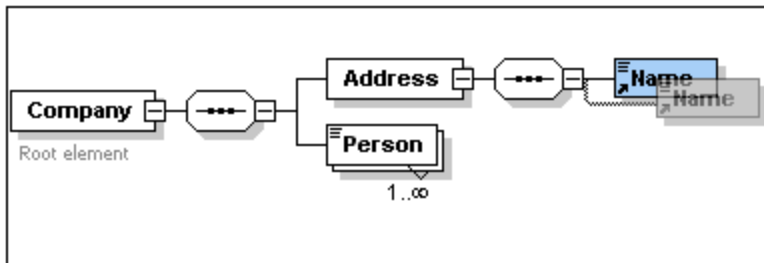

2. Release the mouse button to create the new element in the `Address` sequence. If the new element appears at an incorrect location, drag it to a location below the `Name` element.

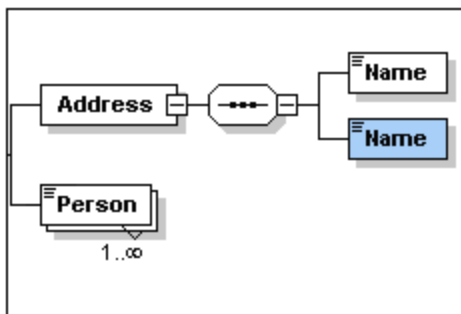

3. Double-click in the element box, and type in `street` to change the element name.
4. Use the same method to create a third element called `city`. The content model should now look like this:

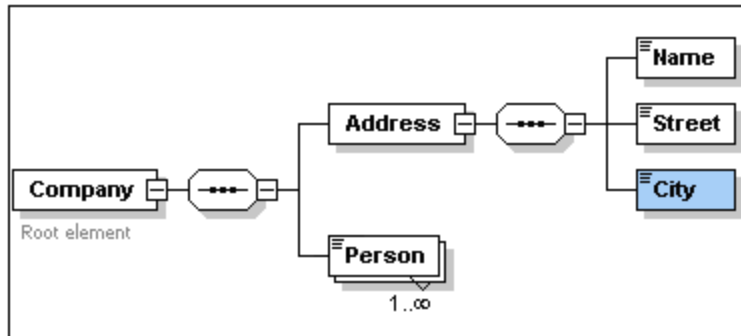



The **Address** element has a sequence of a **Name**, a **Street**, and a **City** element, in that order.

2.2.5 Configuring the Content Model View

This is a good time to configure the Content Model View. We want to configure the view so that an element's type is displayed in the element's box. Do this as follows:

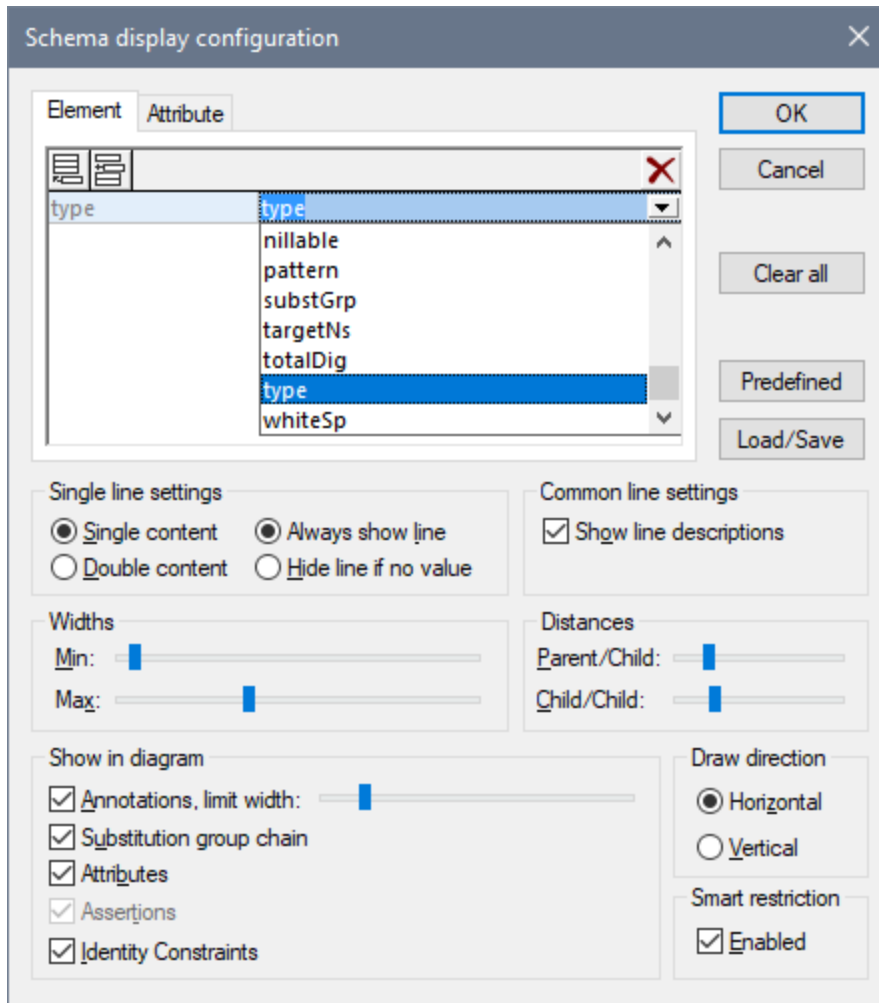
1. Select the Content Model View of any component (by clicking its Content Model View icon ).
2. When in Content Model View, the menu command **Schema Design | Configure View** is enabled. Select the command to display the Schema Display Configuration dialog (*screenshot below*).



3. In the *Element* tab (see screenshot above), click the **Append**  icon, and select *Type* (see screenshot) to add this property descriptor line to element boxes.
4. In the *Single Line Settings* pane, select *Hide line if no value*. This hides the description of the datatype in the element box if the element does not have a datatype (for example, if the element is a complex type). In the screenshot below, notice that the type descriptor line appears for the Name, Street, and City elements, which are simple types of type `xs:string`, but not for the complex type elements. This is because the Hide Line If No Value toggle is selected.

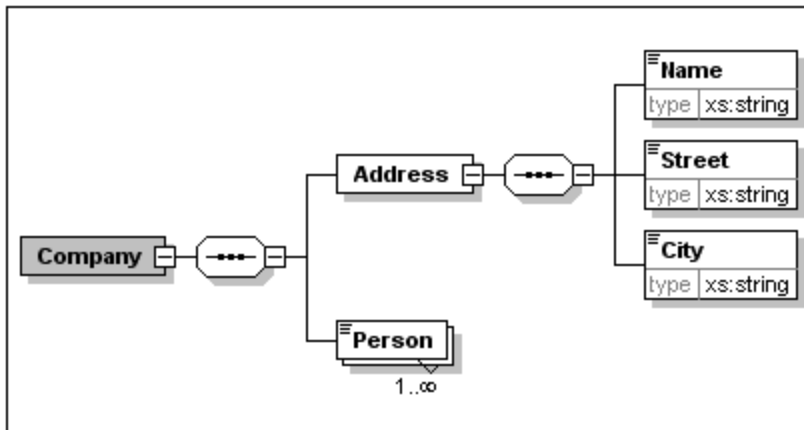

5. In the *Single Line Settings* pane, select the *Always Show Line* radio button.
6. Click **OK** to confirm the changes.

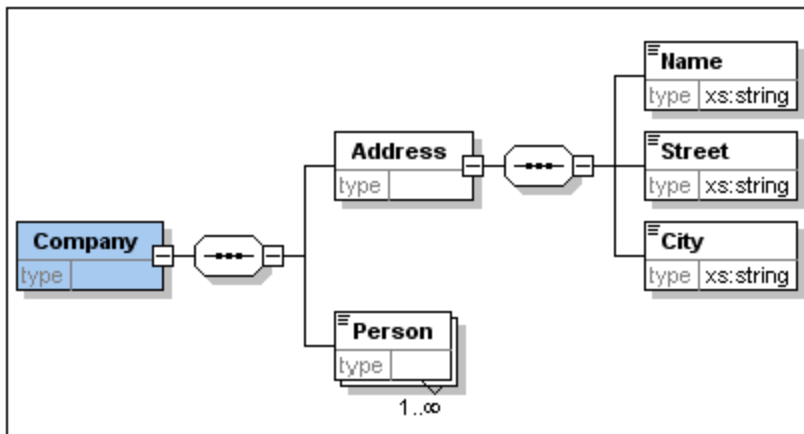

Notice that the descriptor line for the data type is always shown—even in element boxes of complex types, where they appear without any value.

Note the following:

- The property descriptor lines are editable, so values you enter in them become part of the element definition.
- The settings you define in the Schema display configuration dialog apply to the schema documentation output as well as the printer output.

2.2.6 Completing the Basic Schema

You have defined the content of the **Address** element. Now you need to define the content of the **Person** element, which must contain the following simpleType child elements: **First**, **Last**, **Title**, **PhoneExt**, and **Email**. All these elements must be mandatory, except **Title**, and they must occur in the order just specified. All should be of type `xs:string` except **PhoneExt**, which must be of type `xs:integer` and limited to two digits.

To create the content model for **Person**, do the following:

1. Right-click the `Person` element to open the context menu, and select **Add Child | Sequence**. This inserts the Sequence compositor.
2. Right-click the Sequence compositor, and select **Add Child | Element**.
3. Enter `First` as the name of the element, and press the **Tab** key. This automatically places the cursor in the type field.

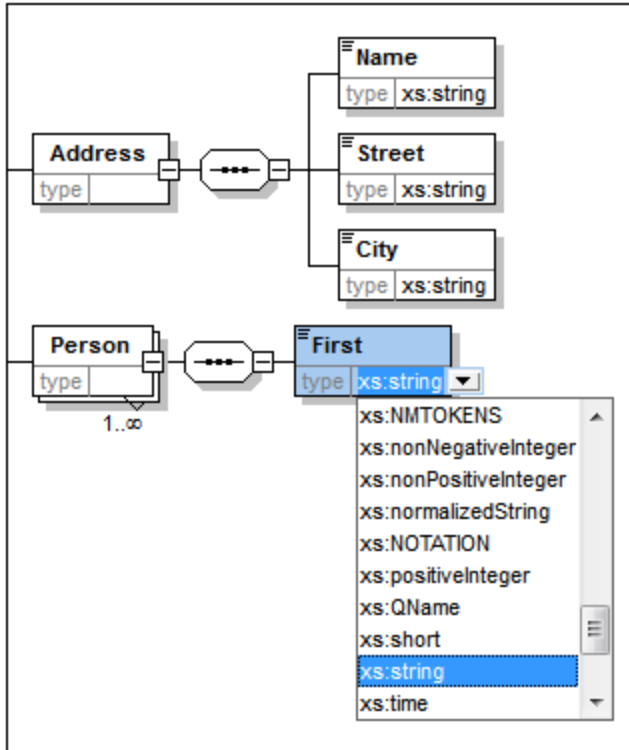

4. Select the `xs:string` entry from the dropdown list or enter it into the *Type* field.
5. Use the drag-and-drop method to create four more elements. Name them `Last`, `Title`, `PhoneExt`, and `Email`, respectively.

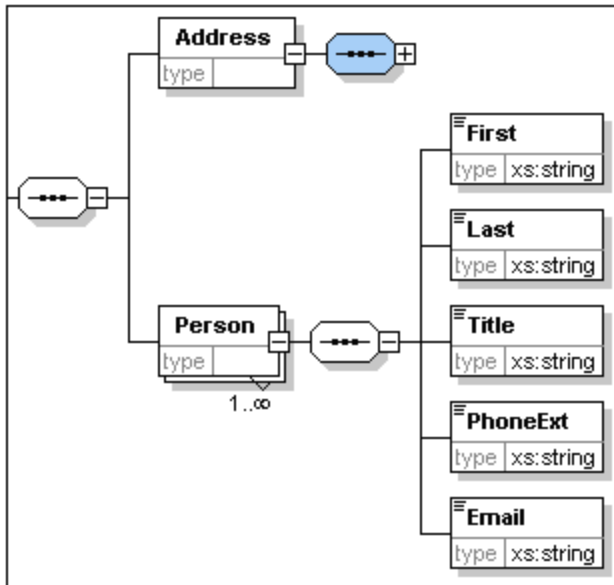

Note: You can select multiple elements by holding down the **Ctrl** key and clicking each of the required elements. This makes it possible to, e.g., copy several elements at once.

Making an element optional

Right-click the `Title` element and select **Optional** from the context menu. The frame of the element box changes from solid to dashed; this is a visual indication that an element is optional.

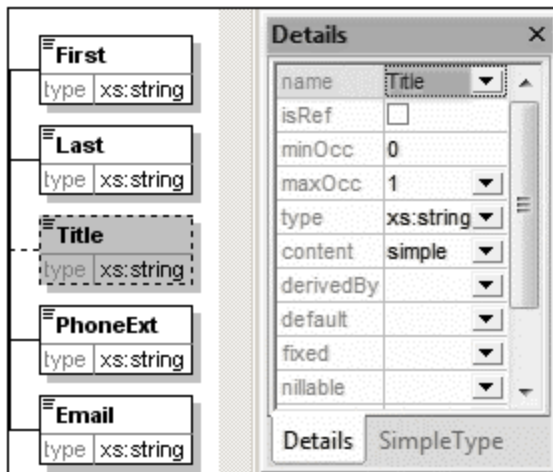

In the Details Entry Helper, you will see that `minOcc=0` and `maxOcc=1`, indicating that the element is optional. Alternatively to using the context menu to make an element optional, you can set `minOcc=0` in order to make the element optional.

Limiting the content of an element

To define the `PhoneExt` element to be of type `xs:integer` and have a maximum of two digits, do the following:

1. Double-click in the type field of the `PhoneExt` element, and select (or enter) the `xs:integer` entry from the dropdown list (see screenshot below).

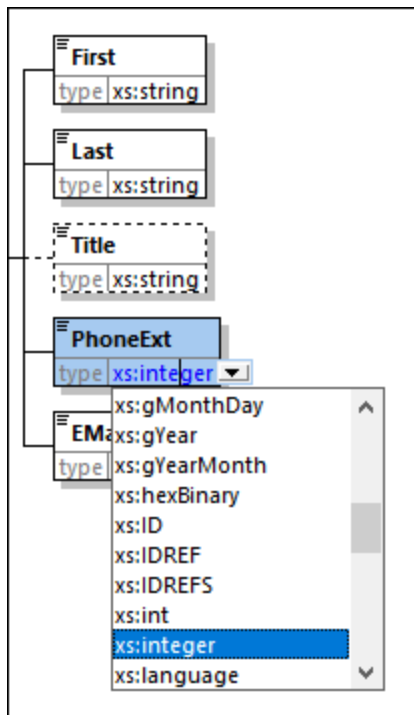

2. The items in the Facets entry helper change at this point. In the Facets entry helper, double-click in the `maxIncl` field and enter 99. Confirm with **Enter**. This specifies that phone extensions can have values from 0 to 99.
3. Select **File | Save** to save the schema changes.

Note the following

- Selecting an XML Schema datatype that is a simple type (for example, `xs:string` or `xs:date`) automatically changes the content model to simple in the Details entry helper (`content = simple`).
- Adding a compositor to an element (sequence, choice, or all), automatically changes the content model to complex in the Details entry helper (`content = complex`).
- The schema described above is available as `AddressFirst.xsd` in the Tutorial folder of your XMLSpy application folder.

2.3 XML Schemas: Advanced

Now that you have created a basic schema, we can move forward to a few advanced aspects of schema development.

Objective



In this section, you will learn how to:

- Work with [complex types and simple types](#)⁵⁷, which can then be used as the types of schema elements.
- Create [global elements](#)⁶⁵ and reference them from other elements.
- Create [attributes](#)⁶⁷ and their properties, including enumerated values.

You will start this section with the basic `AddressFirst.xsd` schema you created in the first part of this tutorial.

Commands used in this section

In this section of the tutorial, you will use Schema View exclusively. The following commands are used:

	Display Diagram (or Display Content Model View). This icon is located to the left of all global components in Schema Overview. Clicking the icon causes the content model of the associated global component to be displayed.
	Display All Globals. This icon is located at the top left-hand corner of the Content Model View. Clicking the icon switches the view to Schema Overview, which displays all global components.
	Append. The Append icon is located at the top left-hand corner of the Schema Overview. Clicking the icon enables you to add a global component.

2.3.1 Working with Complex Types and Simple Types

Having defined the content model of an element, you may decide you want to reuse it elsewhere in your schema. This might happen, for example, if you want to define a content model for addresses in the US and the UK. Some components of the two address formats are common, for example, the street and city components. Other components, however, are different. A sensible strategy, therefore, would be to reuse, in each address content model (US and UK), the common components, and complete each content model with the components that are specific to it (such as ZIP in the US and postal code in the UK). In order to do this, we can create the common components as a global complex type (or, alternatively, each common component as a global element), and reuse the global complex type (or the global elements) in the content model of each address type.

In this section, you will work with global complex types. A complex type is a type definition for elements that contain other elements and/or attributes. You will first create a complex type at the global level and then import it into a content model and extend it. You will learn about global elements later in this tutorial.

Creating a global complex type

The basic **Address** element that we defined (containing **Name**, **Street**, and **City** elements) can be reused in various address formats. So let us create this element definition as a complex type, which can be reused.

To create a global complex type:

1. In the Content Model View, right-click the **Address** element.
2. In the context menu that now appears, select **Make Global | Complex type**. A global complex type called **AddressType** is created, and the **Address** element in the **Company** content model is assigned this type. The content of the **Address** element is the content model of **AddressType**, which is displayed in a yellow box. Notice that the datatype of the **Address** element is now **AddressType**.

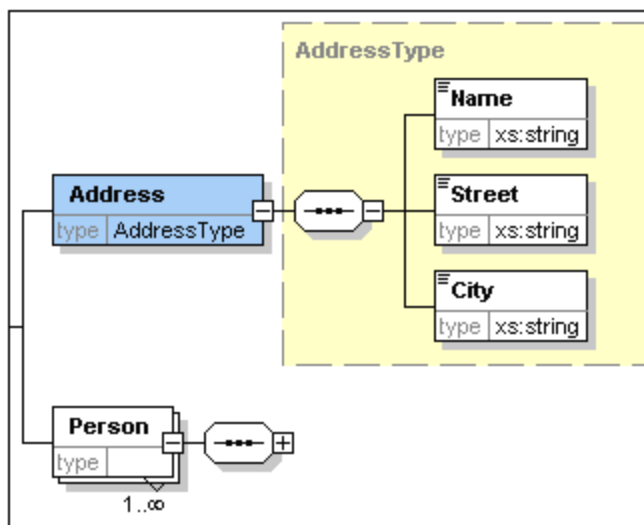

3. Click the Display All Globals  icon. This takes you to the Schema Overview, in which you can view all the global components of the schema.
4. Click the *Expand* icons for the **element** and **complexType** entries in the Components entry helper so that their respective schema constructs are displayed. The Schema Overview now displays two global components: the **Company** element and the complex type **AddressType**. The Components Entry Helper also displays the **AddressType** complex type.

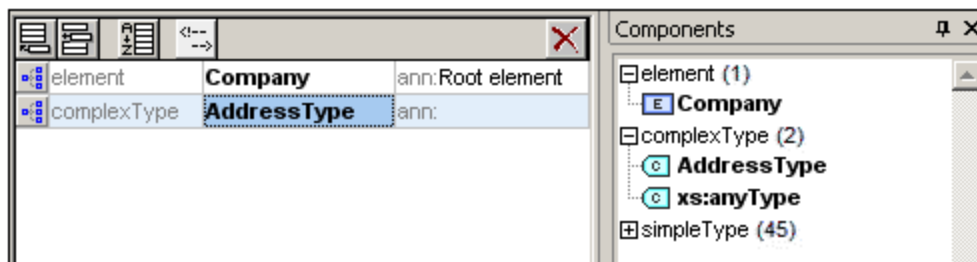

5. Click on the Content Model View icon  of **AddressType** to see its content model (*screenshot below*). Notice the shape of the complex type container.

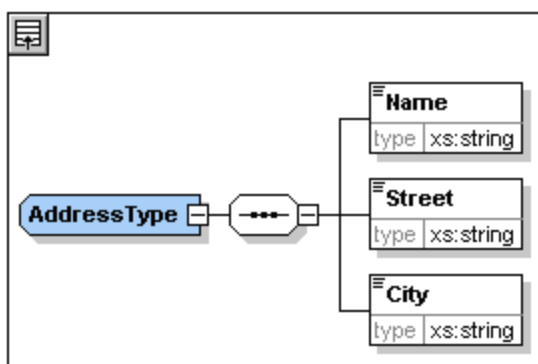



6. Click the Display All Globals icon  to return to the Schema Overview.

Extending a complex type definition

We now want to use the global `AddressType` component to create two kinds of country-specific addresses. For this purpose we will define a new complex type based on the basic `AddressType` component, and then extend that definition.

Do this as follows:

1. Switch to Schema Overview. (If you are in Content Model View, click the Display All Globals icon )
2. Click the **Append** icon  at the top left of the component window. The following menu opens:

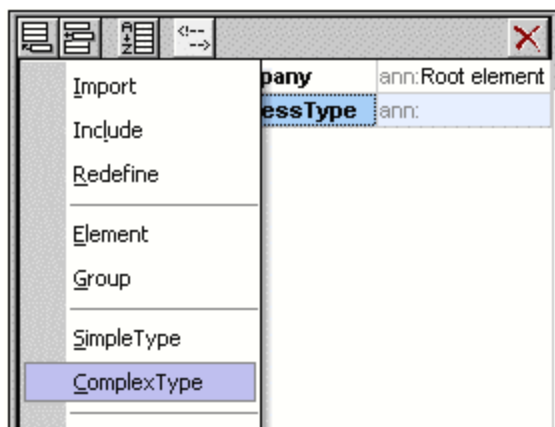

3. Select **ComplexType** from the menu. A new line appears in the component list, and the cursor is set for you to enter the component name.
4. Enter `us-Address` and confirm with **Enter**. (If you forget to enter the hyphen character "-" and enter a space, the element name will appear in red, signalling an invalid character.)

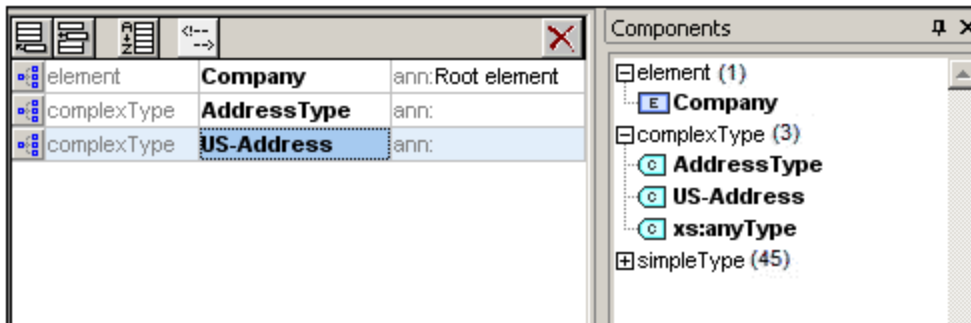

5. Click the Content Model View icon  of **US-Address** to see the content model of the new complex type. The content model is empty (see screenshot below).
6. In the Details entry helper, click the **base** combo box and select the **AddressType** entry.

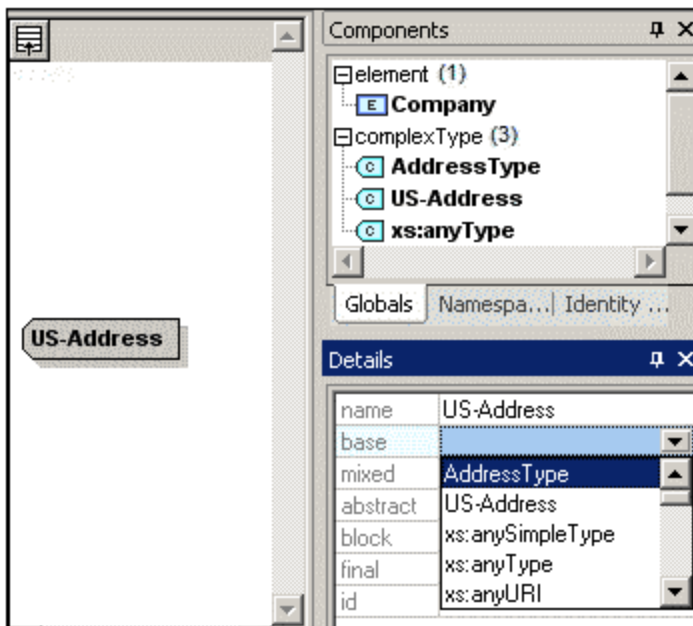

The Content Model View now displays the **AddressType** content model as the content model of **US-Address** (screenshot below).

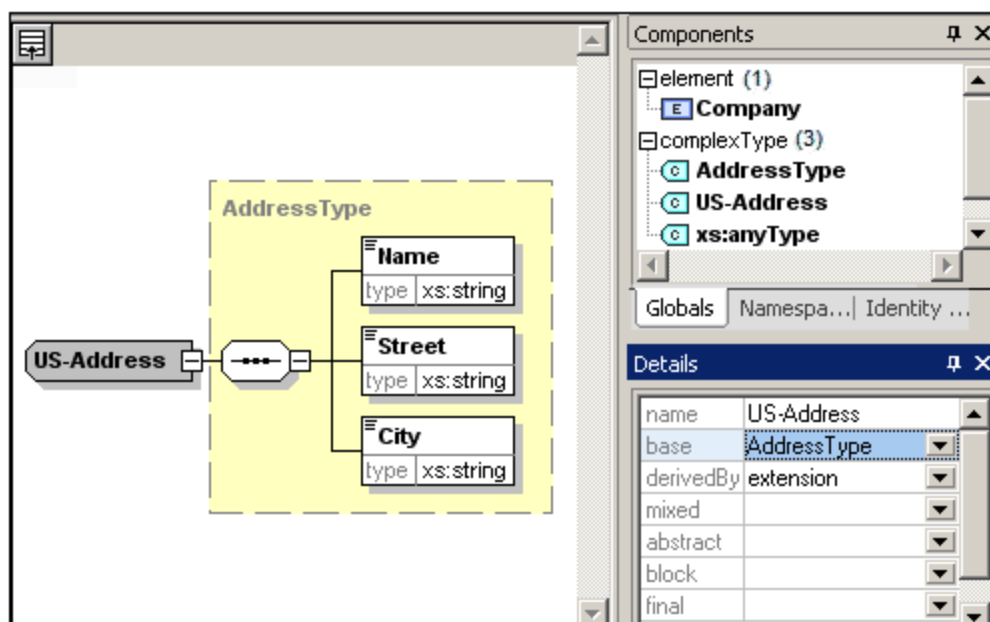

- Now we can extend the content model of the `us-Address` complex type to take a ZIP Code element. To do this, right-click the `us-Address` component, and, from the context menu that appears, select **Add Child | Sequence**. A new sequence compositor is displayed outside the `AddressType` box (screenshot below). This is a visual indication that this is an extension to the element.

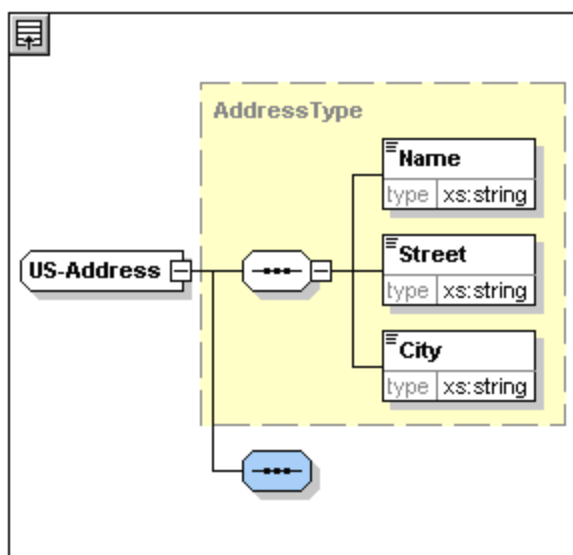

- Right-click the new sequence compositor and select **Add Child | Element**.
- Name the newly created element `zip`, and then press the **Tab** key. This places the cursor in the value field of the type descriptor line.
- Select `xs:positiveInteger` from the dropdown menu that appears, and confirm with **Enter**.

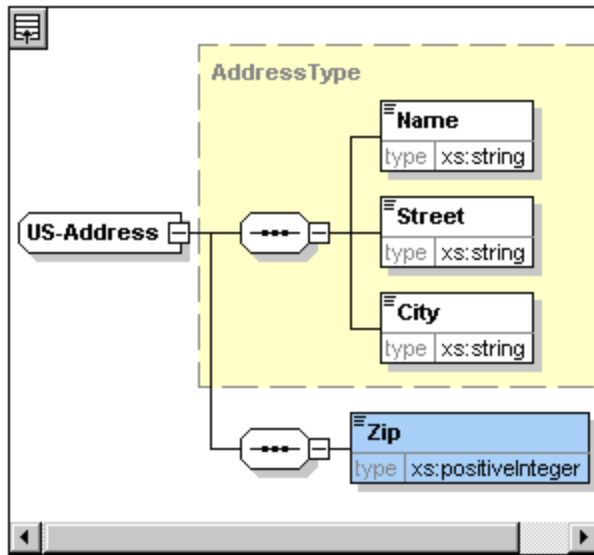

You now have a complex type called `us-Address`, which is based on the complex type `AddressType` and extends it to contain a ZIP code.

Global simple types

Just as the complex type `us-Address` is based on the complex type `AddressType`, an element can also be based on a simple type. The advantage is the same as for global complex types: the simple type can be reused. In order to reuse a simple type, the simple type must be defined globally. In this tutorial, you will define a content model for US states as a simple type. This simple type will be used as the basis for another element.

Creating a global simple type

Creating a global simple type consists of appending a new simple type to the list of global components, naming it, and defining its datatype.

To create a global simple type:

1. Switch to Schema Overview. (If you are in Content Model View, click the Display All Globals icon )
2. Click the **Append** icon, and in the context menu that appears, select **SimpleType**.
3. Enter `us-state` as the name of the newly created simpleType.
4. Press **Enter** to confirm. The simple type `us-state` is created and appears in the list of simple types in the Components Entry Helper (Click the expand icon of the simpleType entry to see it).

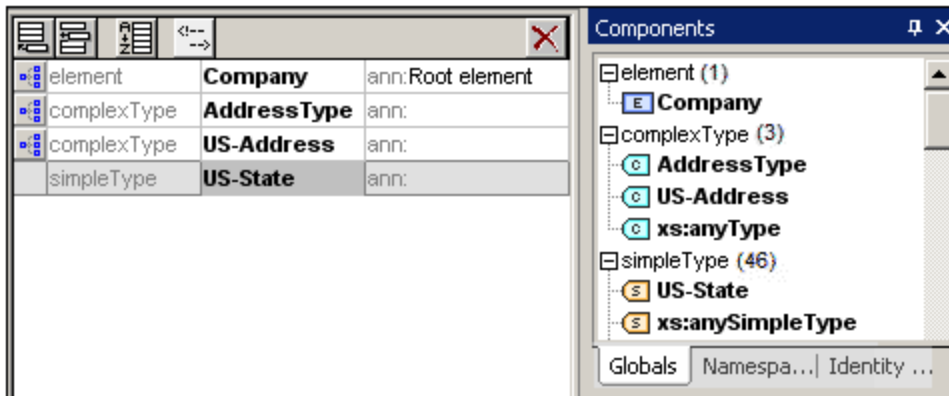

- In the Details Entry Helper (*screenshot below*), place the cursor in the value field of `restr` and enter `xs:string`, or select `xs:string` from the dropdown menu in the `restr` value field.

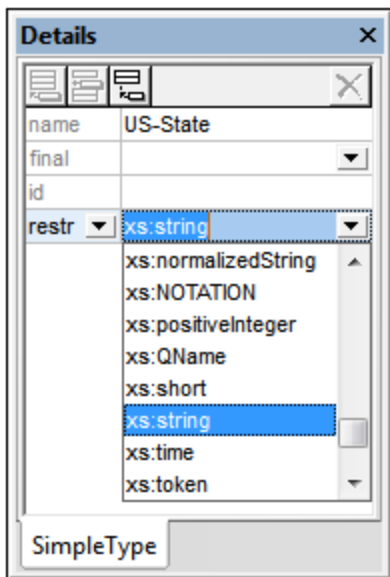

This creates a simple type called `us-state`, which is of datatype `xs:string`. This global component can now be used in the content model of `us-Address`.

Using a global simple type in a content model

A global simple type can be used in a content model to define the type of a component. We will use `us-state` to define an element called `state` in the content model of `us-Address`.

Do the following:

- In Schema Overview, click the Component Model View icon  of `us-Address`.
- Right-click the lower sequence compositor and select **Add Child | Element**.
- Enter `state` for the element name.
- Press the **Tab** key to place the cursor in the value field of the type descriptor line.
- From the drop-down menu of this combo box, select `us-state`.

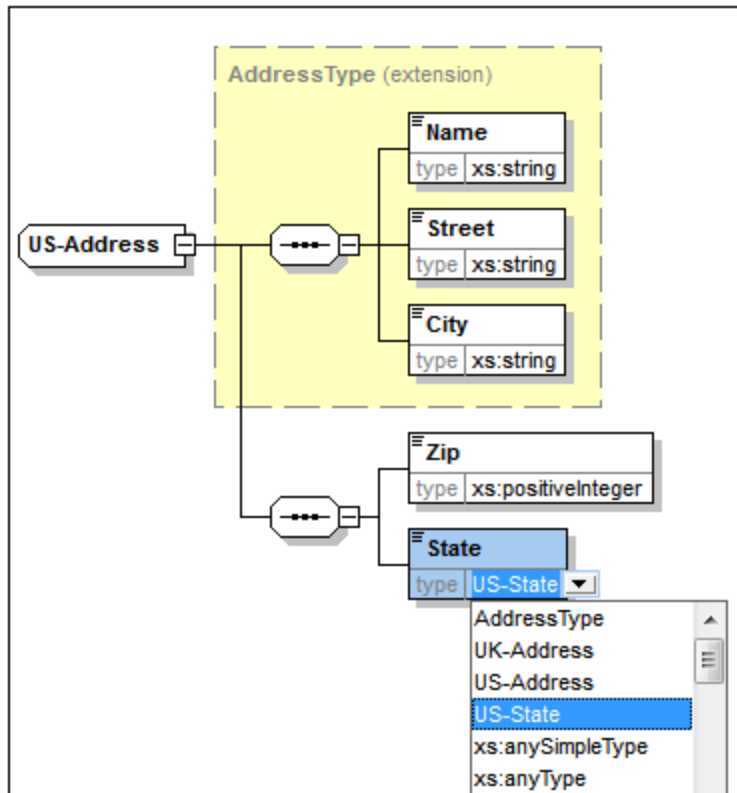

The `State` element is now based on the `us-state` simple type.

Creating a second complex type based on `AddressType`

We will now create a global complex type to hold UK addresses. The complex type is based on `AddressType`, and is extended to match the UK address format.

Do the following:

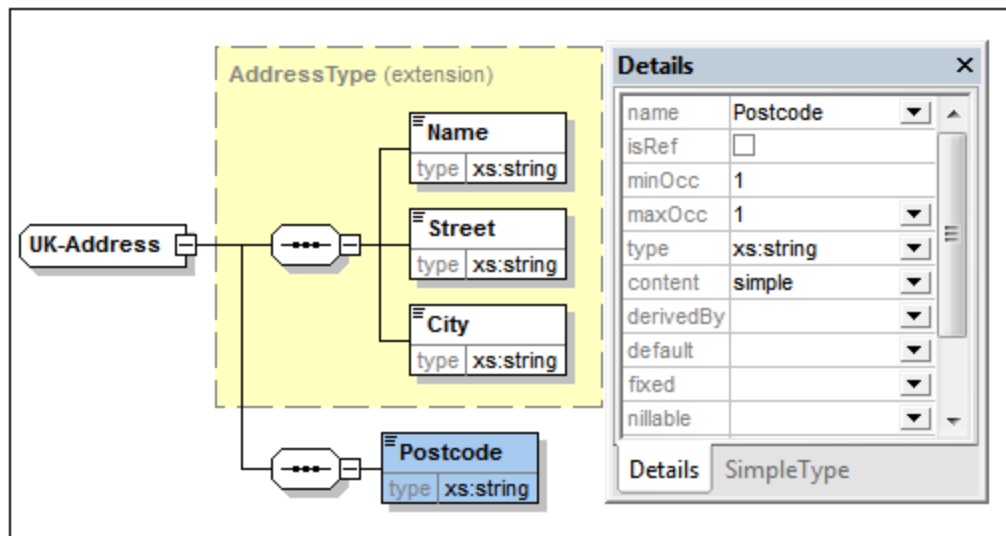

1. In Schema Overview, create a global complex type called `UK-Address`, and base it on `AddressType` (`base=AddressType`).
2. In the Content Model View of `UK-Address`, add a `Postcode` element and give it a type of `xs:string`. Your `UK-Address` content model should look like this:





Note: In this section you created global simple and complex types, which you then used in content model definitions. The advantage of global types is that they can be reused in multiple definitions.

2.3.2 Referencing Global Elements

In this section, we will convert the locally defined `Person` element to a global element and reference that global element from within the `Company` element.

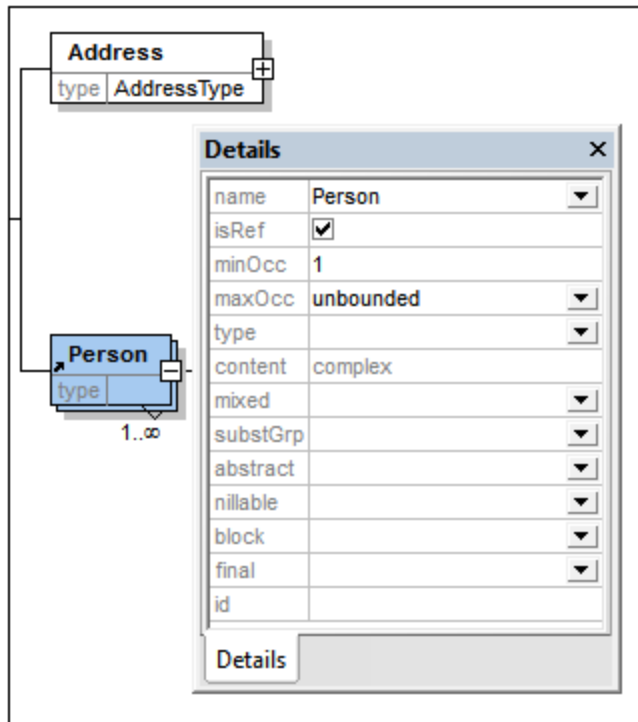
1. Click  (Display All Globals) to switch to Schema Overview.
2. Click the Display Diagram icon  of the `Company` element.
3. Right-click the `Person` element, and select **Make Global | Element**. A small link arrow icon appears in the `Person` element, showing that this element now references the globally declared `Person` element. In the Details Entry Helper, the `isRef` check box is now activated.



- Click the Display All Globals icon  to return to Schema Overview. The `Person` element is now listed as a global element. It is also listed in the Components Entry Helper.

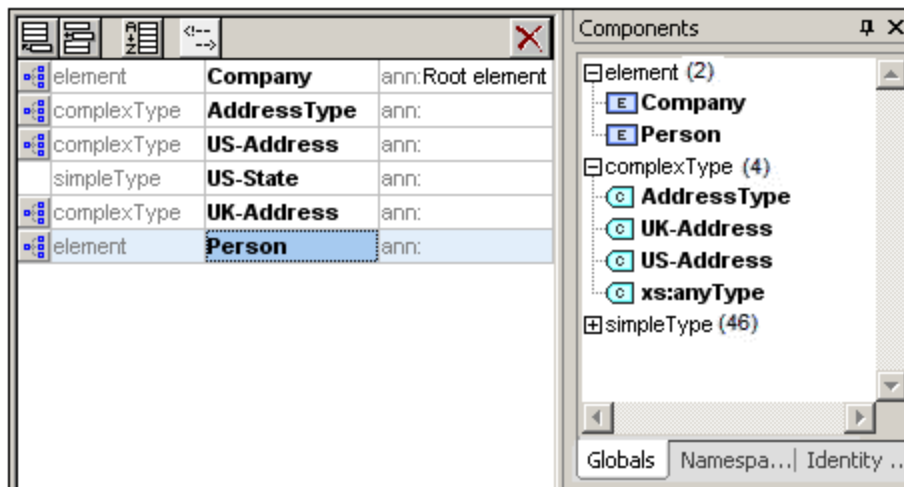

- In the Components Entry Helper, double-click the `Person` element to see the content model of the global `Person` element.

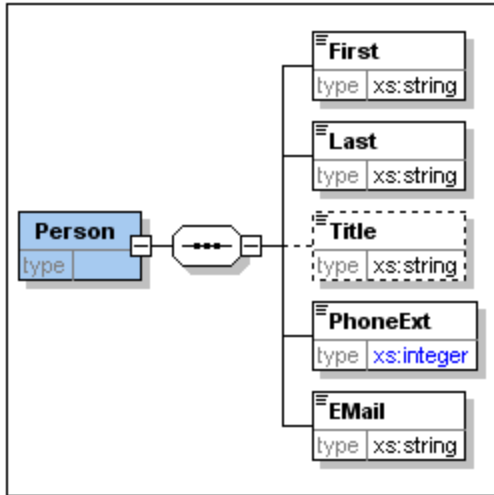

Notice that the global element box does **not** have a link arrow icon. This is because it is the referenced element, not the referencing element. It is the referencing element that has the link arrow icon.

Note the following:

- An element that references a global element must have the same name as the global element it references.
- A global declaration does not describe where a component is to be used in an XML document. It only describes a content model. It is only when a global declaration is referenced from within another component that its location in the XML document is specified.
- A globally declared element can be reused at multiple locations. It differs from a globally declared complex type in that its content model cannot be modified without also modifying the global element itself. If you change the content model of an element that references a global element, then the content model of the global element will also be changed, and, with it, the content model of all other elements that reference that global element.

2.3.3 Attributes and Attribute Enumerations

In this section, you will learn how to create attributes and enumerations for attributes.

Defining element attributes

1. In the Schema Overview, click the **Person** element to make it active.
2. Click the **Append** icon , in the top left of the Attributes/Identity Constraints tab group (in the lower part of the Schema Overview window), and select the Attribute entry.

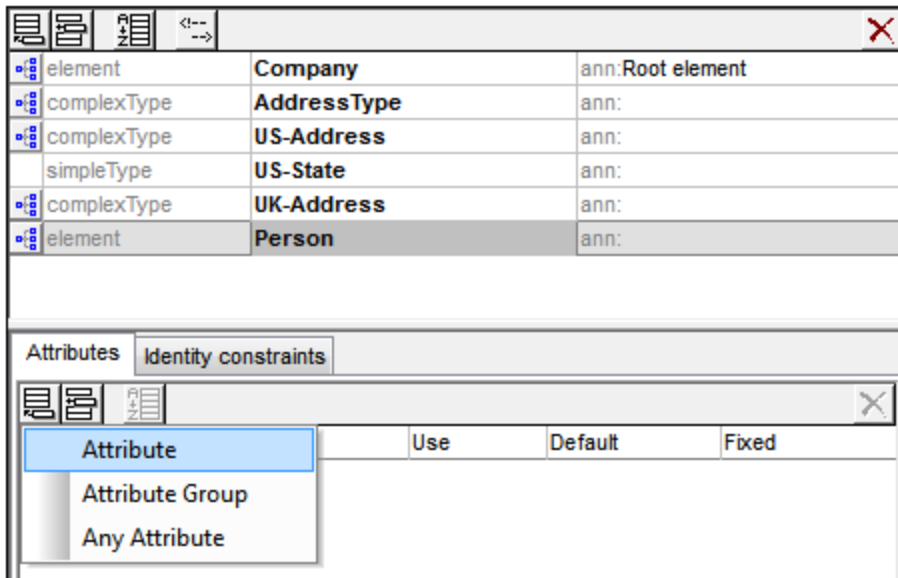

3. Enter `Manager` as the attribute name in the Name field.
4. Use the *Type* combo box to select `xs:boolean`.
5. Use the *Use* combo box to select required.

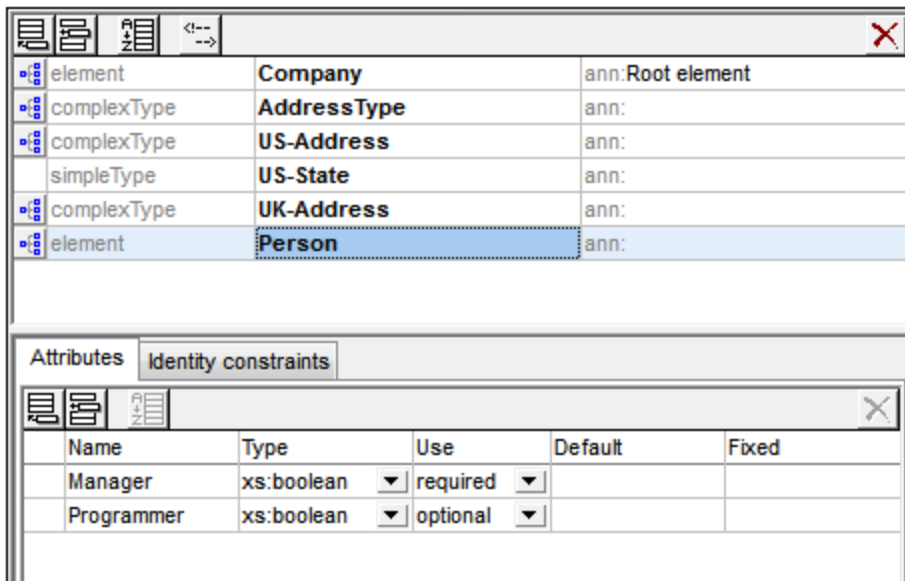

6. Use the same procedure to create a `Programmer` attribute with `Type=xs:boolean` and `Use=optional`.



Defining enumerations for attributes

Enumerations are values allowed for a given attribute. If the value of the attribute in the XML instance document is not one of the enumerations specified in the XML Schema, then the document is invalid. We will create enumerations for the `Degree` attribute of the `Person` element.

Do the following:

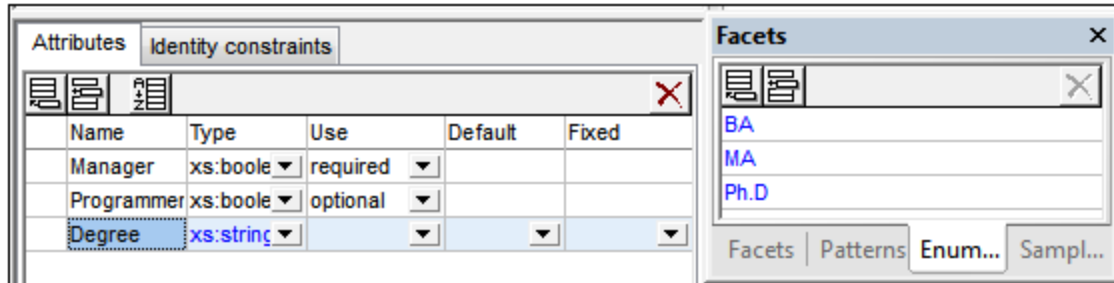
1. In the Schema Overview, click the **Person** element to make it active.
2. Click the **Append** icon  in the top left of the Attributes window, and select the Attribute entry.
3. Enter **Degree** as the attribute name, and select **xs:string** as its type.
4. With the **Degree** attribute selected, in the Facets Entry Helper, click the **Enumerations** tab (see *screenshot*).



5. In the **Enumerations** tab, click the Append icon .
6. Enter **BA**, and confirm with **Enter**.
7. Use the same procedure to add two more enumerations: **MA** and **PhD**.
8. Click on the Content Model View icon  of **Person**.

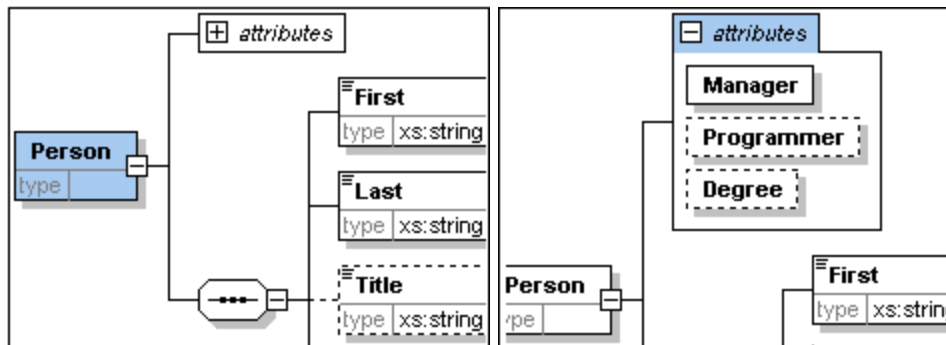

The previously defined attributes are visible in the Content Model View. Clicking the expand icon displays all the attributes defined for that element. This display mode and the Attributes tab can be toggled by selecting the menu option **Schema Design | Configure view**, and checking and unchecking the **Attributes** check box in the **Show in diagram** pane.

9. Click the Display all Globals icon  to return to the Schema Overview.

Saving the completed XML Schema

Before saving your schema file, rename the **AddressLast.xsd** file that is delivered with XMLSpy to something else (such as **AddressLast_original.xsd**), so as not to overwrite it. Save the completed schema with any name you like (**File | Save as**). We recommend that you save it with the name **AddressLast.xsd**. This is because the the XML file you will create in the next part of the tutorial will be based on the **AddressLast.xsd** schema.

2.4 XML Schemas: XMLSpy Features

After having completed the XML Schema, we suggest you become familiar with a few [navigation shortcuts](#)⁷⁰ and learn about the [schema documentation](#)⁷² that you can generate from within XMLSpy. These are described in the subsections of this section.

Commands used in this section

In this section of the tutorial, you will use Schema View exclusively. The following commands are used:

	Display Diagram (or Display Content Model View). This icon is located to the left of all global components in Schema Overview. Clicking the icon causes the content model of the associated global component to be displayed.
---	---

2.4.1 Schema Navigation

This section shows you how to navigate Schema View efficiently. We suggest that you try out these navigation mechanisms to become familiar with them.

Displaying the content model of a global component

Global components that can have content models are complex types, elements, and element groups. The Content Model View of these components can be opened in the following ways:

- In Schema Overview, click the **Display Diagram** icon  to the left of the component name.
- In either Schema Overview or Content Model View, double-click the element, complex type, or element group in the Components Entry Helper (*screenshot below*). This displays the content model of that component.

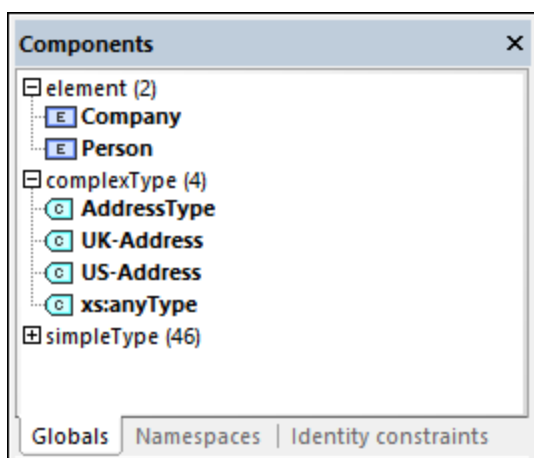

If you double-click any of the other global components (simple type, attribute, attribute group) in the Components Entry Helper, that component will be highlighted in Schema Overview (since such a component would not have a content model).

In the Components Entry Helper, the double-clicking mechanism works in both the Globals and Namespaces tabs.

Going to the definition of a global element from a referencing element

If a content model contains an element that references a global element, you can go directly to the content model of that global element or to any of its contained components by holding down **Ctrl** and double-clicking the required element.

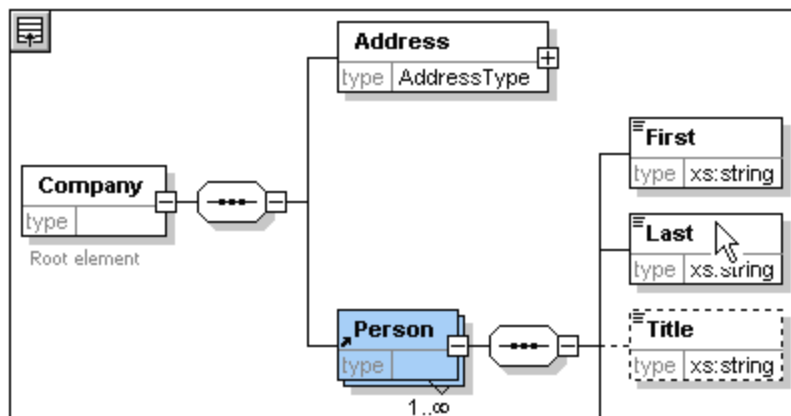

When the `Last` element is highlighted, all its properties are immediately displayed in the relevant entry helpers and information window.

Going to the definition of a complex type

Complex types are often used as the type of some element within a content model. To go directly to the definition of a complex type from within a content model, double-click the **name** of the complex type in the yellow box (see mouse pointer in screenshot below).

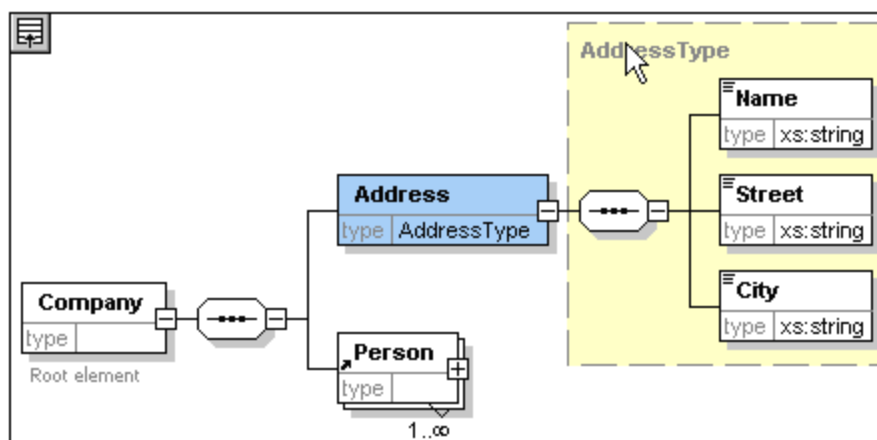

This takes you to the Content Model View of the complex type.

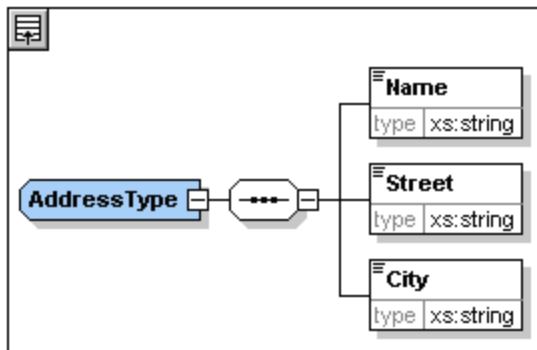

Note: Just as with referenced global elements, you can go directly to an element within the complex type definition by holding down **Ctrl** and double-clicking the required element in the content model that contains the complex type.

2.4.2 Schema Documentation

XMLSpy provides detailed documentation of XML Schemas in HTML and Microsoft Word (MS Word) formats. You can select the components and the level of detail you want documented. Related components are hyperlinked in both HTML and MS Word documents. In order to generate MS Word documentation, you must have MS Word installed on your computer (or network).

In this section, we will generate documentation for the `AddressLast.xsd` XML Schema.

Do the following:

1. Select the menu option **Schema design | Generate documentation**. This opens the Schema Documentation dialog.

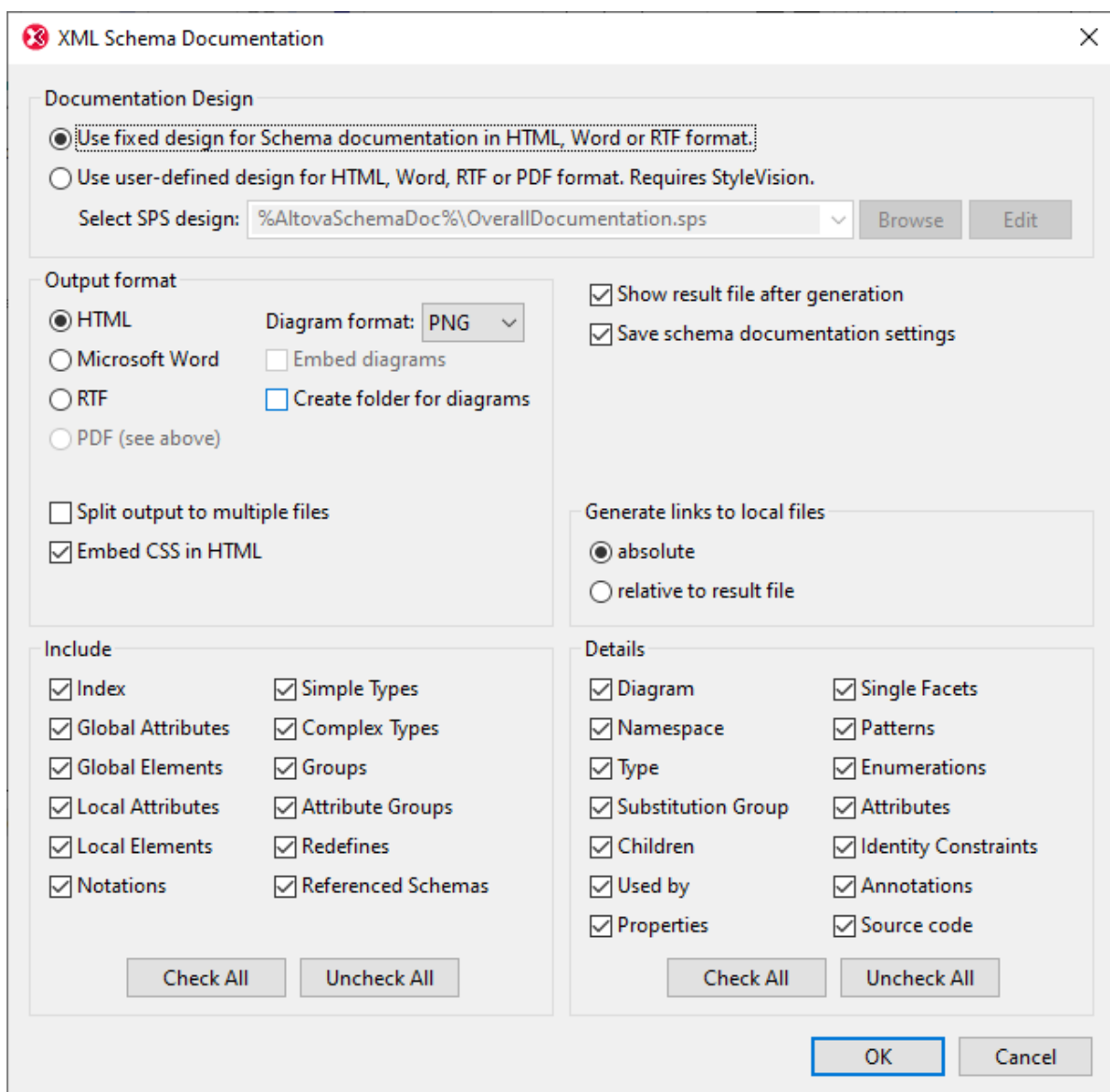

2. For the Output Format option, select HTML, and click **OK**.
3. In the Save As dialog, select the location where the file is to be saved and give the file a suitable name (say `AddressLast.html`). Then click the **Save** button.

The HTML document appears in the Browser View of XMLSpy. Click on a link to go to the corresponding linked component.

Schema **AddressLast.xsd**

schema location: <C:\Users\alU\Documents\Altova\XML Spy2013\Examples\Tutorial\AddressLast.xsd>

attributeFormDefault: **unqualified**

elementFormDefault: **qualified**

targetNamespace: <http://my-company.com/namespace>

Elements [Complex types](#) [Simple types](#)

[Company](#) [AddressType](#) [US-State](#)

[Person](#) [UK-Address](#)

[US-Address](#)

element **Company**

diagram	
namespace	http://my-company.com/namespace
properties	content complex
children	Address Person
annotation	documentation Root element
source	<pre><xs:element name="Company"> <xs:annotation> <xs:documentation>Root element</xs:documentation> </xs:annotation> <xs:complexType> <xs:sequence> <xs:element name="Address" type="AddressType"/> <xs:element ref="Person" maxOccurs="unbounded"/> </xs:sequence> </xs:complexType> </xs:element></pre>

The diagram above shows the **first page** of the schema documentation in HTML form. If components from other schemas have been included, then those schemas are also documented.

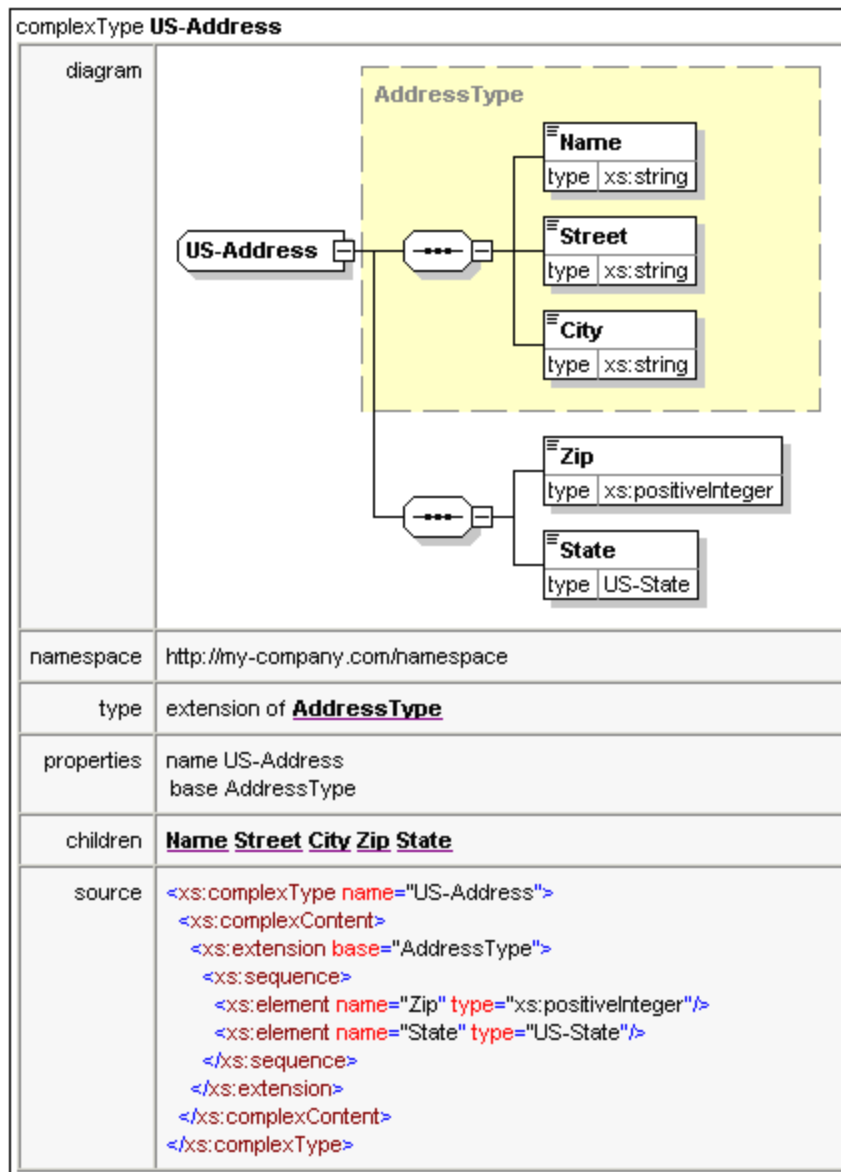

The diagram above shows how complex types are documented.

element US-Address/Zip	
diagram	
namespace	http://my-company.com/hamespace
type	xs:positiveInteger
properties	name Zip isRef 0 content simple
source	<code><xs:element name="Zip" type="xs:positiveInteger"/></code>
element US-Address/State	
diagram	
namespace	http://my-company.com/hamespace
type	US-State
properties	name State isRef 0 content simple
source	<code><xs:element name="State" type="US-State"/></code>
simpleType US-State	
namespace	http://my-company.com/hamespace
type	xs:string
properties	name US-State
used by	element US-Address/State
source	<code><xs:simpleType name="US-State"> <xs:restriction base="xs:string"/> </xs:simpleType></code>

The diagram above shows how elements and simple types are documented.

You can now try out the MS Word output option. The Word document will open in MS Word. To use hyperlinks in the MS Word document, hold down **Ctrl** while clicking the link.

2.5 XML Documents

In this section you will learn how to create and work with XML documents in XMLSpy. You will also learn how to use the various intelligent editing features of XMLSpy.







Objective

The objectives of this section are to learn how to do the following:

- Create a new XML document based on the `AddressLast.xsd` schema.
- Specify the type of an element so as to make an extended content model for that element available to the element during validation.
- Insert elements and attributes and enter content for them in Grid View and Text View using intelligent entry helpers.
- Copy XML data from XMLSpy to Microsoft Excel; add new data in MS Excel; and copy the modified data from MS Excel back to XMLSpy. This functionality is available in the Table Display of Grid View.
- Sort XML elements using the sort functionality of Table Display.
- Validate the XML document.
- Modify the schema to allow for three-digit phone extensions.

Commands used in this section

In this section of the tutorial, you will mostly use the Grid View and Text View, and in one section Schema View. The following commands are used:

	File New. Creates a new type of XML file.
	View Text View. Switches to Text View.
	View Grid View. Switches to Enhanced Grid View.
	XML Display as Table. Displays multiple occurrences of a single element type at a single hierarchic level as a table. This view of the element is called its Table Display. The icon is used to switch between the Table Display and regular Grid View.
	F7. Checks for well-formedness.
	F8. Validates the XML document against the associated DTD or Schema.
	Opens the associated DTD or XML Schema file.

2.5.1 Creating a New XML File

When you create a new XML file in XMLSpy, you are given the option of basing it on a schema (DTD or XML Schema) or not. In this section you will create a new file that is based on the `AddressLast.xsd` schema you created earlier in the tutorial.

To create the new XML file:

1. Select the menu option **File | New**. The *Create new document* dialog opens.

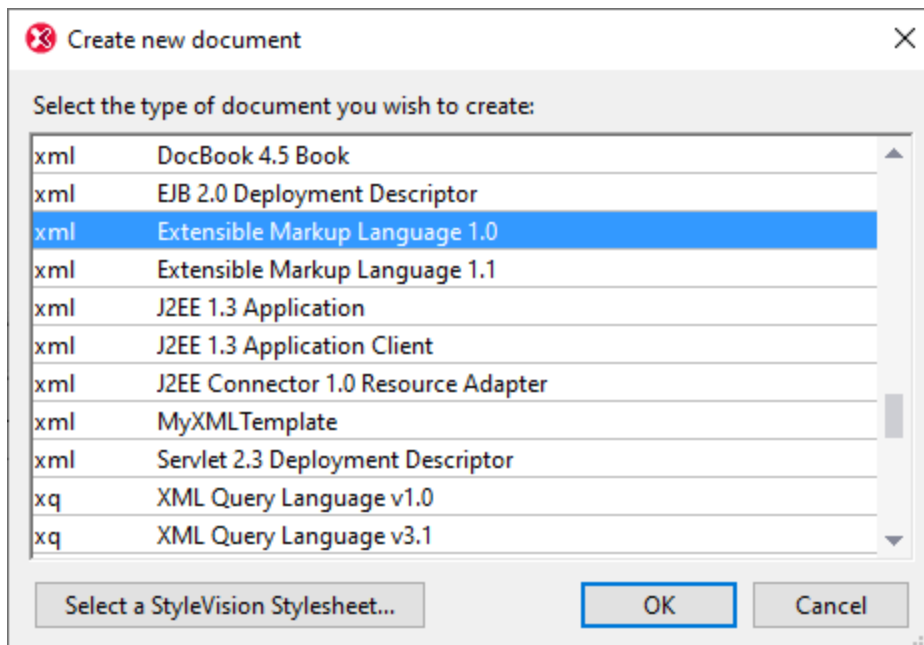

2. Select *Extensible Markup Language 1.0* and confirm with **OK**. The Choose Schema or DTD dialog appears.

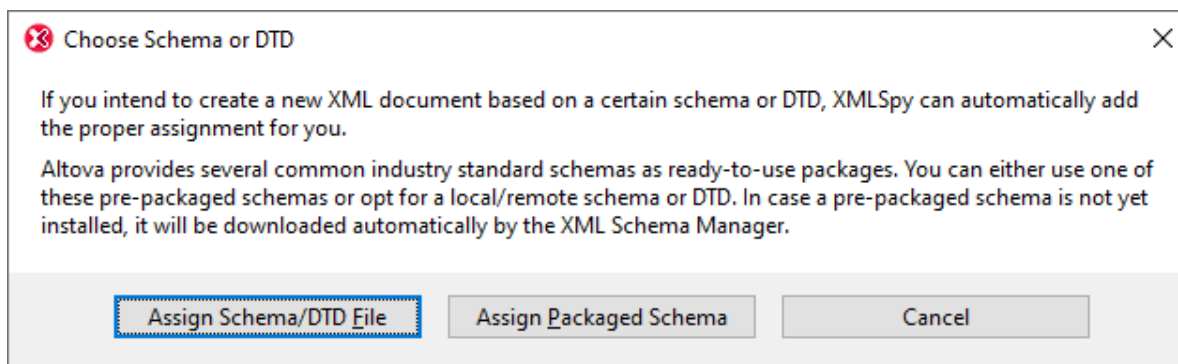

3. Click **Assign Schema/DTD File**.
4. In the dialog that appears, use either the **Browse** button or **Window** button to find the schema file. (The **Window** button lists all files currently open in XMLSpy.) Select **AddressLast.xsd** (see [Tutorial introduction](#) ³⁰ for location), and confirm with **OK**. An XML document containing the main elements defined by the schema opens in the main window.
5. Click the Grid tab to select Grid View.
6. In Grid View, notice the structure of the document. Click on any element to reduce selection to that element. Your document should look something like this:

XML	version	1.0
	encoding	UTF-8
	standalone	
<> Company	xmlns	http://my-company.com/namespace
	xmlns:xsi	http://www.w3.org/2001/XMLSchema-instance
	xsi:schemaLocation	http://my-company.com/namespace Tutorial%5CAddressLast.xsd
	<> Address	<Address> <Name/> <Street/> <City/> </Address>
	<> Person	<Person Manager=""> <First/> <Last/> <PhoneExt/> <Email/> </Person>

7. Click on the  icon next to **Address**, to view the child elements of **Address**. Your document should look like this:

<> Company	xmlns	http://my-company.com/namespace						
	xmlns:xsi	http://www.w3.org/2001/XMLSchema-instance						
	xsi:schemaLocation	http://my-company.com/namespace Tutorial%5CAddressLast.xsd						
	<> Address	<table border="1"> <tr> <td><> Name</td> <td></td> </tr> <tr> <td><> Street</td> <td></td> </tr> <tr> <td><> City</td> <td></td> </tr> </table>	<> Name		<> Street		<> City	
<> Name								
<> Street								
<> City								
	<> Person	<Person Manager=""> <First/> <Last/> <PhoneExt/> <Email/> </Person>						

8. Select the menu option **File | Save** and save it in the **Tutorial** folder. Give your XML document a suitable name (for example **CompanyFirst.xml**). Note that the finished tutorial file **CompanyFirst.xml** is in the **Tutorial** folder, so you may need to rename it before you give that name to the file you have created.

2.5.2 Specifying the Type of an Element

The child elements of **Address** are those defined for the global complex type **AddressType** (the content model of which is defined in the XML Schema **AddressLast.xsd** shown in the Schema View screenshot below).

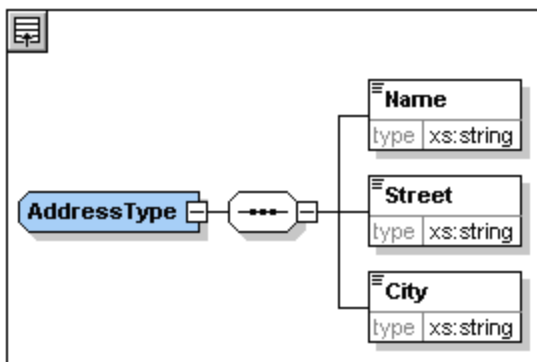

We would, however, like to use a specific US or UK address type rather than the generic address type. You will recall that, in the `AddressLast.xsd` schema, we created global complex types for `US-Address` and `UK-Address` by extending the `AddressType` complex type. The content model of `US-Address` is shown below.

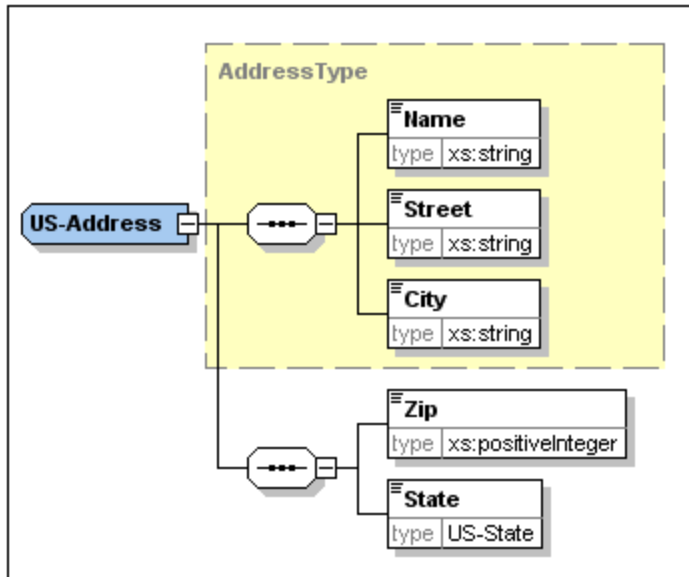

In the XML document, in order to specify that the `Address` element must conform to one of the extended `Address` types (`US-Address` or `UK-Address`) rather than the generic `AddressType`, we must specify the required extended complex type as an attribute of the `Address` element.

We add this attribute of the `Address` element as follows:

1. In the XML document, right-click the `Name` element, and select **Insert Before** from the context menu (see screenshot below).

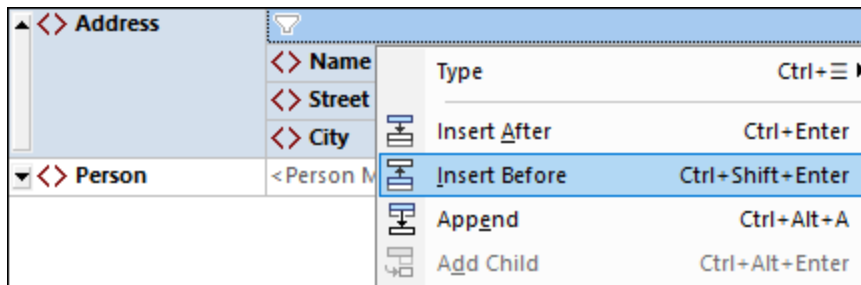

2. A new element node named `new_elem` is added above the `Name` element (see screenshot below). Click the element type to the left of the node's name and, in the menu that appears (screenshot below), select the `Attribute` node type. The node type will be changed to the `Attribute` node type; however, the name is still `new_elem`.

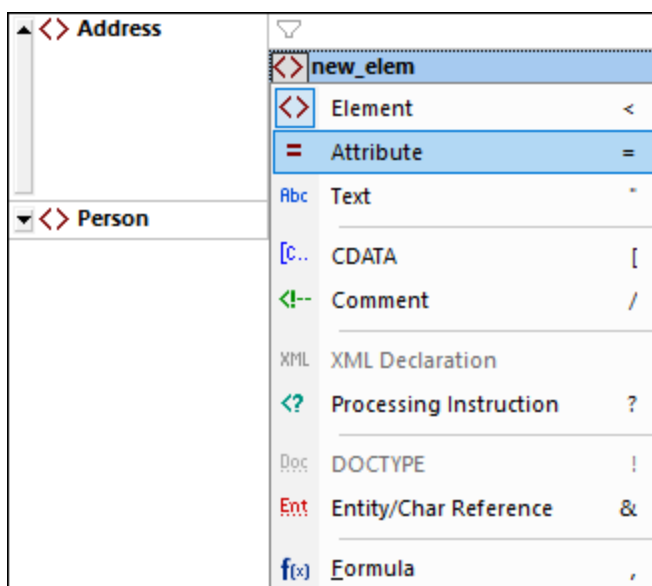

3. Double-click the node name and, in the entry helper popup that appears, select `xsi:type`.
4. Press the **Tab** key to move to the attribute's value field. A popup menu containing the available `xsi:type` values is displayed (*screenshot below*). These values are the complex types that have been defined for the `Address` element in the schema.

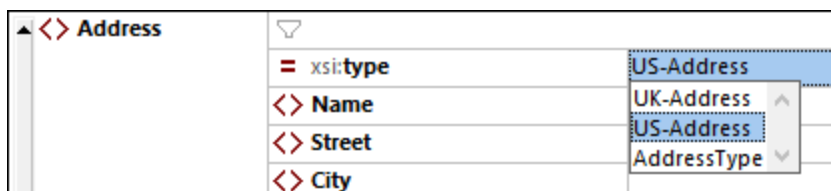

5. Select `US-Address` as the value of the `xsi:type` attribute.

Note: The `xsi:` prefix allows you to use special XML Schema related commands in your XML document instance. Notice that the the namespace for the `xsi:` prefix was automatically added to the document element when you assigned a schema to your XML file. In the above case, you have specified a type for the `Address` element. See the [XML Schema specification](#) for more information.

2.5.3 Entering Data in Grid View

You can now enter data into your XML document. Do the following:

1. Double-click in the `Name` value field (or use the arrow keys) and enter *US dependency*. Confirm with **Enter**.

▲ <> Company	▼	
= xmlns		http://my-company.com/namespace
= xmlns:xsi		http://www.w3.org/2001/XMLSchema-instance
= xsi:schemaLocation		http://my-company.com/namespace AddressLast.xsd
▲ <> Address	▼	
= xsi:type		US-Address
<> Name		US dependency
<> Street		
<> City		

2. Use the same method to enter a **street** and **city** name (for example, *Noble Ave* and *Dallas*).
3. Click the **Person** element and press **Delete** to delete the **Person** element. (We will add it back in the next section of the tutorial.) After you do this, the entire **Address** element is highlighted.
4. Click on any child element of the **Address** element to deselect all the child elements of **Address** except the selected element. Your XML document should look like this:

▼ XML	<?xml version="1.0" encoding="UTF-8"?>	
▲ <> Company	▼	
= xmlns		http://my-company.com/namespace
= xmlns:xsi		http://www.w3.org/2001/XMLSchema-instance
= xsi:schemaLocation		http://my-company.com/namespace AddressLast.xsd
▲ <> Address	▼	
= xsi:type		US-Address
<> Name		US dependency
<> Street		Noble Ave
<> City		Dallas

2.5.4 Entering Data in Text View

Text View presents the actual data and markup of XML files in an easy-to-follow structural layout, as well as schema-related intelligent editing features.

Document layout

The document layout of Text View is defined in two locations:

Pretty-printing options

These settings are in the Pretty-printing section of the Options dialog (*screenshot below*). When you set an option, its effect can be immediately seen in the preview pane at bottom. Set up the pretty-printing options as you like. While you are editing in Text View, you might find that the document's layout becomes unstructured, especially after you copy-paste blocks of text. Whenever you want to obtain a neat and hierarchical layout, simply click the **Edit | Pretty Print** command.

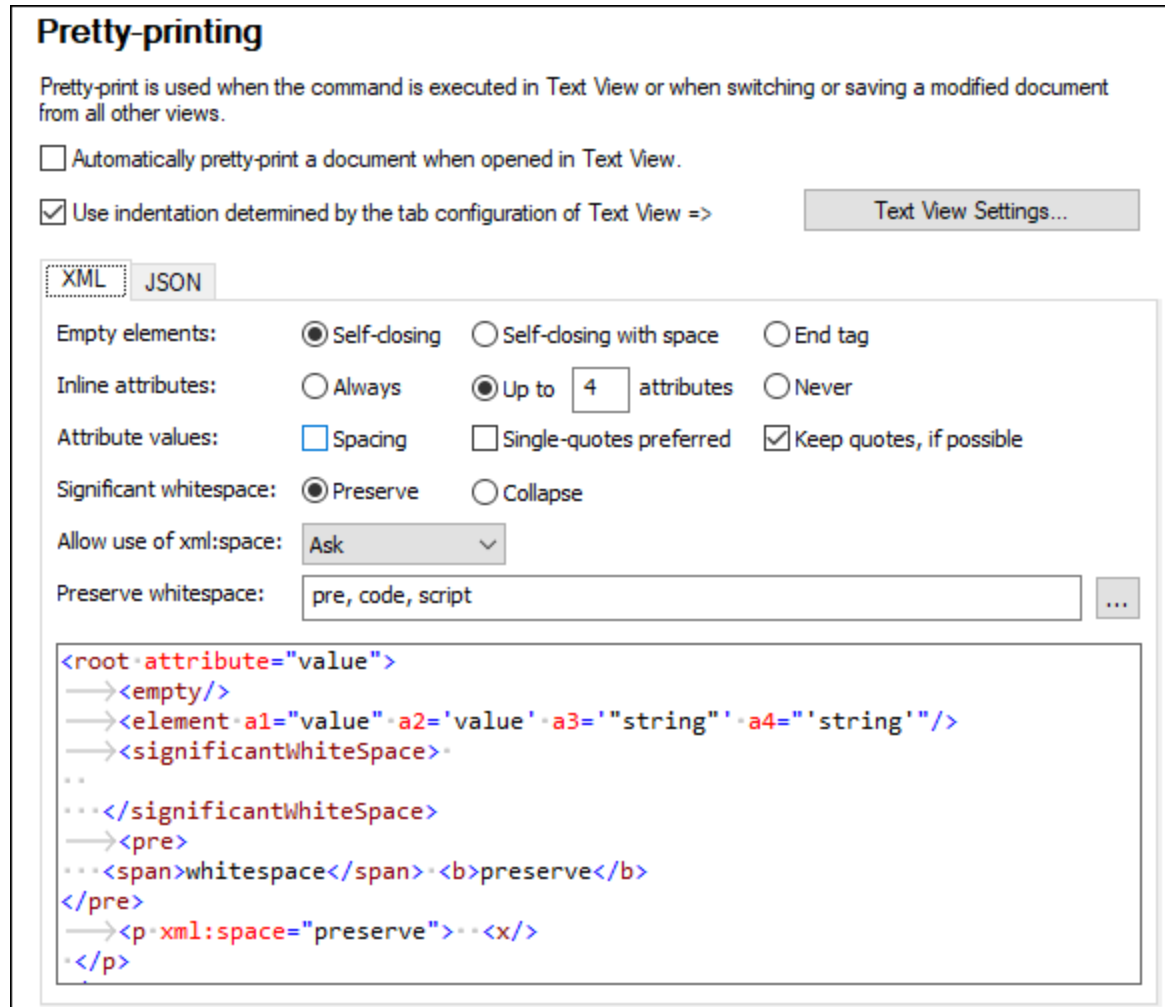

Text View settings

The Text View Settings dialog (*screenshot below*) not only provides additional layout options but also switches on/off useful Text View features such as line numbering and folding margins. Access the Text View Settings dialog with the **View | Text View Settings** command.

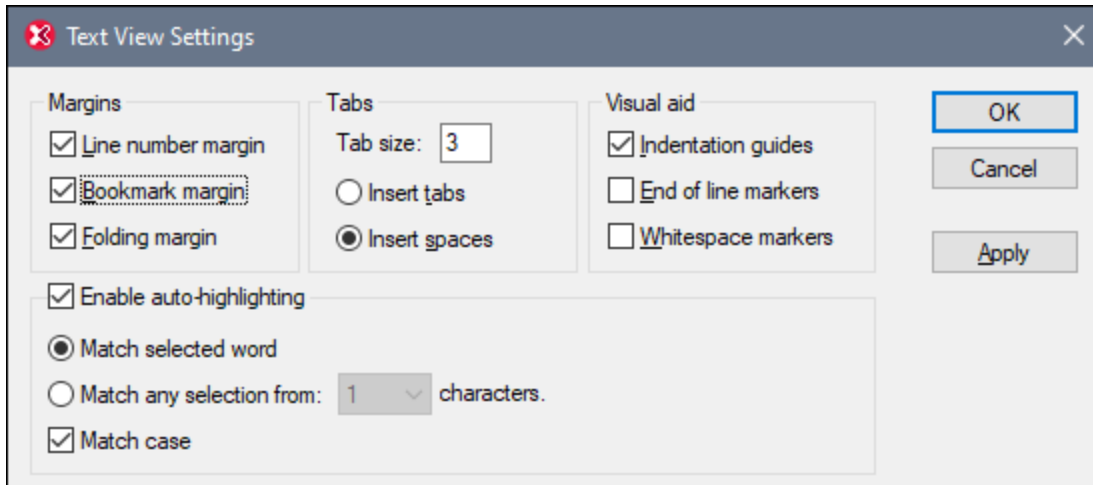

The screenshot below shows the current XML file in Text View with features switched on according to the settings in the dialog above.

```

1  <?xml version="1.0" encoding="UTF-8"?>
2  <!-- edited with XMLSpy 2021 -->
3  <Company xmlns="http://my-company.com/namespace"
4  xmlns:xsi="http://www.w3.org/2001/XMLSchema-instance"
5  xsi:schemaLocation="http://my-company.com/namespace AddressLast.xsd">
6  <Address xsi:type="US-Address">
7      <Name>US dependency</Name>
8      <Street>Noble Ave.</Street>
9      <City>Dallas</City>
10 </Address>
11 </Company>

```

On the left are the three margins: (i) the line number margin, (ii) the bookmark margin (containing two blue bookmarks), and (iii) the source folding margin (which allows you to expand and collapse the display of XML elements). Indentation guides are the light gray vertical lines that show the indentation of tags at the same hierarchical level. Additionally visual aids are end-of-line markers and whitespace markers, which can be switched on or off in the *Visual Aid* pane (see *screenshot above*).

Note: The Text View-related pretty-printing and bookmark features were covered in the earlier [Text View Settings](#) ³⁷ section of this tutorial.

Editing in Text View

In this section, you will enter and edit data in Text View in order to become familiar with the features of Text View.

Note: Since the *Validate on Edit* feature is switched on by default, any validation error created during editing will be immediately flagged, with the error message/s being displayed in the Messages Window. Ignore these errors and messages for now. If you do not want background validation, you can switch off *Validate on Edit* in the [Validation settings of the Options dialog](#) ¹⁰⁴. In the event you do this, note that you can always validate your document at any time (described in the [next section](#) ⁸⁷ of this tutorial).

Do the following:

1. Select the menu item **View | Text View**, or click on the **Text** tab. You now see the XML document in its text form, with syntax coloring.
2. Place the text cursor after the end tag of the **Address** element, and press **Enter** to add a new line.
3. Enter the less-than angular bracket **<** at this position. A dropdown list of all elements allowed at that point (according to the schema) is displayed. Since only the **Person** element is allowed at this point, it will be the only element displayed in the list.

```
<?xml version="1.0" encoding="UTF-8"?>
<!-- edited with XMLSpy 2021 -->
<Company xmlns="http://my-company.com/namespace" xmlns:xsi="http://www.w3.org/2001/XMLSchema-instance"
xsi:schemaLocation="http://my-company.com/namespace AddressLast.xsd">
  <Address xsi:type="US-Address">
    <Name>US dependency</Name>
    <Street>Noble Ave.</Street>
    <City>Dallas</City>
  </Address>
  <
    Person
  </Company>
```

4. Select the **Person** entry. The **Person** element, as well as its attribute **Manager**, are inserted, with the cursor inside the value-field of the **Manager** attribute.
5. From the dropdown list that pops up for the **Manager** attribute, select **true**.

```
</Address>
<Person Manager=""
</Company>
```

6. Move the cursor to the end of the line (using the **End** key if you like), and press the space bar. This opens a dropdown list containing a list of attributes allowed at that point. Also, in the Attributes Entry Helper, the available attributes are listed in red. The **Manager** attribute is grayed out because it has already been used.

```
</Address>
<Person Manager="true"
</Company>
```

≡	Degree
≡	Programmer
≡	xsi:type

Attributes	
≡	Degree
≡	Programmer
≡	xsi:type
≡	Manager

7. Select **Degree** with the Down arrow key, and press **Enter**. This opens another list box, from which you can select one of the predefined enumerations (**BA**, **MA**, or **Ph.D**). (Enumerations are values that are allowed by the XML Schema.)

```
</Address>
<Person Manager="true" Degree=""
</Company>
```

- Select **BA** with the Down arrow key and confirm with **Enter**. Then move the cursor to the end of the line (with the **End** key), and press the space bar. **Manager** and **Degree** are now grayed out in the Attributes Entry Helper.

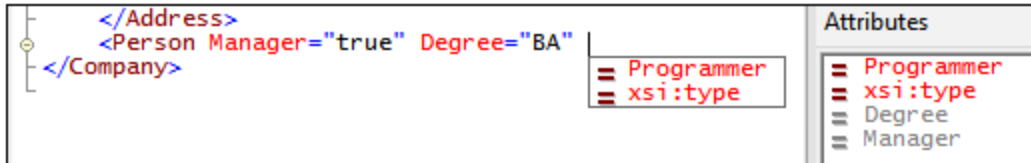

- Select **Programmer** with the Down arrow key and press **Enter**.

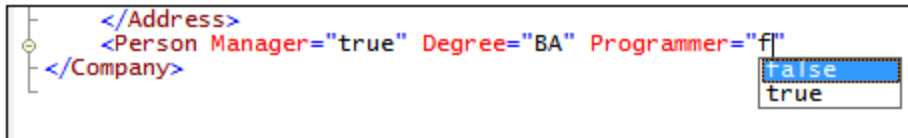

- Enter the letter "f" and press **Enter**.
- Move the cursor to the end of the line (with the **End** key), and enter the greater-than angular bracket >. XMLSpy automatically inserts all the required child elements of **Person**. (Note that the optional **Title** element is not inserted.) Each element has start and end tags but no content.



You could now enter the **Person** data in Text View, but let's move to Grid View to see the flexibility of moving between views when editing a document.

Switching to Grid View

To switch to Grid View, select the menu item **View | Grid View**, or click the **Grid** tab. See how the newly added child nodes of **Person** are displayed.



XML	<?xml version="1.0" encoding="UTF-8"?>																									
Company	<table border="1"> <tr><td>xmlns</td><td>http://my-company.com/namespace</td></tr> <tr><td>xmlns:xsi</td><td>http://www.w3.org/2001/XMLSchema-instance</td></tr> <tr><td>xsi:schemaLocation</td><td>http://my-company.com/namespace AddressLast.xsd</td></tr> <tr><td>Address</td><td><Address xsi:type="US-Address"> <Name>US dependency</Name></td></tr> <tr><td>Person</td><td> <table border="1"> <tr><td>Manager</td><td>true</td></tr> <tr><td>Degree</td><td>BA</td></tr> <tr><td>Programmer</td><td>false</td></tr> <tr><td>First</td><td></td></tr> <tr><td>Last</td><td></td></tr> <tr><td>PhoneExt</td><td></td></tr> <tr><td>Email</td><td></td></tr> </table> </td></tr> </table>		xmlns	http://my-company.com/namespace	xmlns:xsi	http://www.w3.org/2001/XMLSchema-instance	xsi:schemaLocation	http://my-company.com/namespace AddressLast.xsd	Address	<Address xsi:type="US-Address"> <Name>US dependency</Name>	Person	<table border="1"> <tr><td>Manager</td><td>true</td></tr> <tr><td>Degree</td><td>BA</td></tr> <tr><td>Programmer</td><td>false</td></tr> <tr><td>First</td><td></td></tr> <tr><td>Last</td><td></td></tr> <tr><td>PhoneExt</td><td></td></tr> <tr><td>Email</td><td></td></tr> </table>	Manager	true	Degree	BA	Programmer	false	First		Last		PhoneExt		Email	
xmlns	http://my-company.com/namespace																									
xmlns:xsi	http://www.w3.org/2001/XMLSchema-instance																									
xsi:schemaLocation	http://my-company.com/namespace AddressLast.xsd																									
Address	<Address xsi:type="US-Address"> <Name>US dependency</Name>																									
Person	<table border="1"> <tr><td>Manager</td><td>true</td></tr> <tr><td>Degree</td><td>BA</td></tr> <tr><td>Programmer</td><td>false</td></tr> <tr><td>First</td><td></td></tr> <tr><td>Last</td><td></td></tr> <tr><td>PhoneExt</td><td></td></tr> <tr><td>Email</td><td></td></tr> </table>	Manager	true	Degree	BA	Programmer	false	First		Last		PhoneExt		Email												
Manager	true																									
Degree	BA																									
Programmer	false																									
First																										
Last																										
PhoneExt																										
Email																										

Now let us validate the document and correct any errors that the validation finds.

2.5.5 Validating the Document

XMLSpy provides two important checks of the XML document:

- A well-formedness check
- A validation check

	Check Well-Formedness
	Validate XML

Since the *Validate on Edit* feature is switched on by default, any validation error created during editing will be immediately flagged, with the error message/s being displayed in the Messages Window. If you do not want background validation, you can switch off *Validate on Edit* in the [Validation settings of the Options dialog](#)⁽¹⁰⁴⁾. In the event you do this, note that you can always carry out well-formed checks and validation checks at any time by invoking the respective command in the XML menu. This part of the tutorial shows you how to carry out these checks.

Checking well-formedness

An XML document is well-formed if starting tags match closing tags, elements are nested correctly, and there are no misplaced or missing characters (such as an entity without its semi-colon delimiter). You can do a well-formedness check in any editing view. Check your document as follows:

1. Select Text View.
2. Select the menu option **XML | Check Well-Formedness** or press the **F7** key. (Alternatively, you can click the command's icon in the toolbar.) A message appears in the Messages window at the bottom of the Main Window saying the document is well-formed.

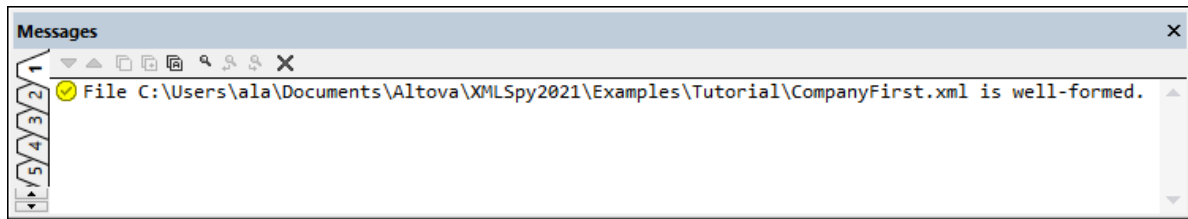

Notice that the output of the Messages window has nine tabs, with the action's result always being displayed in the active tab. So you could check well-formedness in Tab1, and switch to Tab2 for a validation check. If you do not switch tabs, the new result overwrites the previous result in the active tab.

Note: This check does not check the the XML document for conformance with the schema. Schema conformance is evaluated in the validity check.

Checking validity

An XML document is valid according to a schema if it conforms to the document structure and document content specified in that schema. You can do a validity check in any editing view. Validate your document as follows:

1. Select Grid View.
2. Select the menu option **XML | Validate** or press the **F8** key. (Alternatively, you can click the command's icon in the toolbar.) An error message appears in the Messages window saying the file is not valid. Mandatory elements are expected after the `city` element in `Address`. If you check your schema, you will see that the `us-Address` complex type (which you have set this `Address` element to be via its `xsi:type` attribute) has a content model in which the `city` element must be followed by a `zip` element and a `state` element.

Fixing the invalid document

The point at which the document becomes invalid is highlighted in red, together with an error flag and a [smart fix](#)²⁹⁴. The invalid element in this case is the `Address` element. If you click the smart fix icon, you will see the popup: *Add missing element <Zip> with sample content*. If you check the schema, you will find that the `Address/city` element must be followed by the mandatory element `zip`. To double-check this, select the `city` element and look at the Siblings entry helper. You will notice that the `zip` element is prefixed with an exclamation mark, which indicates that the element is mandatory in the current context.

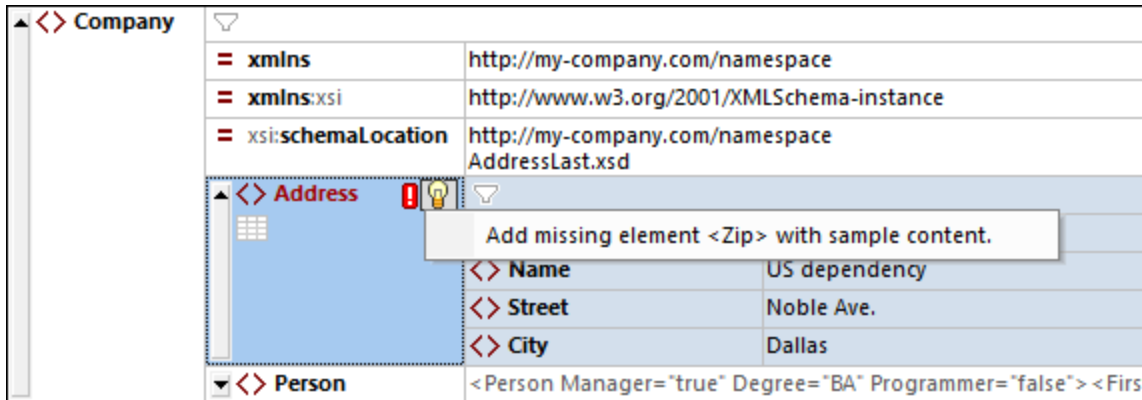

Now click the smart fix (see screenshot above). The `zip` element will be added and will contain sample content that makes the element valid. Enter the correct `zip` code (say `04812` for Dallas). Look at the Siblings entry helper again. It now shows that the `state` element is mandatory (it is prefixed with an exclamation mark). If you select the `state` element, the entry helper options available for it become enabled (see screenshot below). These are the actions to insert the `state` element after the element currently selected in the Main Window (which is `city`) or to append `state` after all the sibling elements of `city`.

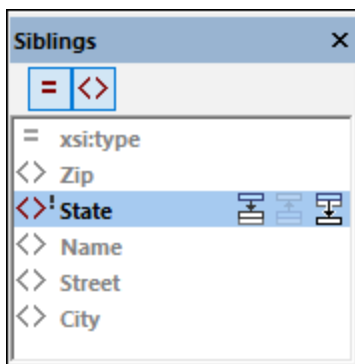

Since, in this case, both actions have the same effect, select either of the two actions. A `state` element is added after `city`. Double-click inside the contents field of `state` and enter the state's name, `Texas` (screenshot below). Notice that the Siblings entry helper now contains only grayed-out elements, indicating that there are no more mandatory elements to add.

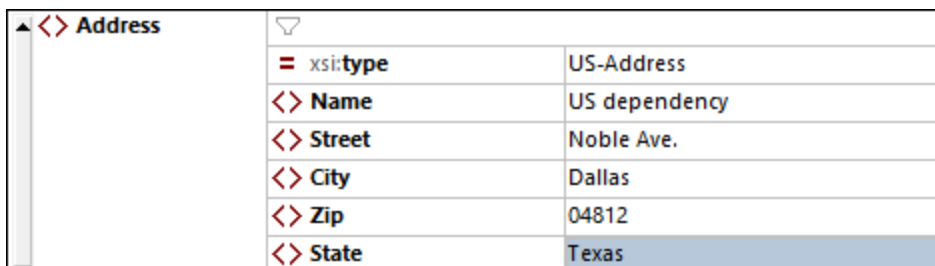

Completing the document and revalidating

Let us now complete the document (by entering the remaining data of the first `Person` element) before revalidating.

Do the following:

1. Click the value field of the element `First`, and enter a first name (say `Fred`). Then press **Enter**.

Person	
= Manager	true
= Degree	BA
= Programmer	false
<> First	Fred
<> Last	
<> PhoneExt	
<> Email	

2. In the same way enter data for all the child elements of `Person`, that is, for `Last`, `PhoneExt`, and `Email`. You can use the Tab key to move forward through the cells. Note that the value of `PhoneExt` must be an integer with a maximum value of 99 (since this is the range of allowed `PhoneExt` values you defined in your schema). Your XML document should then look something like this in Grid View:

Company	
= xmlns	http://my-company.com/namespace
= xmlns:xsi	http://www.w3.org/2001/XMLSchema-instance
= xsi:schemaLocation	http://my-company.com/namespace AddressLast.xsd
Address	
= xsi:type	US-Address
<> Name	US dependency
<> Street	Noble Ave.
<> City	Dallas
Person	
= Manager	true
= Degree	BA
= Programmer	false
<> First	Fred
<> Last	Smith
<> PhoneExt	22
<> Email	Smith@work.com

3. Click  again to check if the document is valid. A message appears in the Messages window stating that the file is valid. The XML document is now valid against its schema.

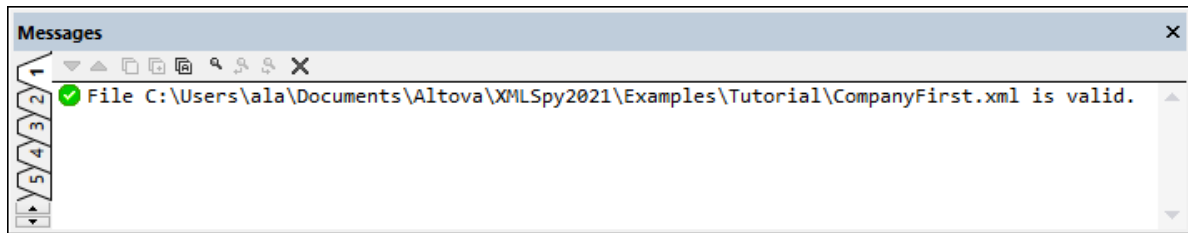

4. Save the file with **File | Save**.

Note: An XML document does not have to be valid in order to save it. Saving an invalid document causes a prompt to appear warning you that you are about to save an invalid document. You can select **Save anyway**, if you wish to save the document in its current invalid state.

2.5.6 Adding Elements and Attributes

At this point, there is only one `Person` element in the document.

To add a new `Person` element, do the following:

1. Click the gray sidebar to the left of the `Address` element to collapse the `Address` element. This clears up some space in the view.
2. Select the entire `Person` element by clicking on or below the name of the `Person` element in Grid View. Notice that the `Person` element is now available in the Siblings entry helper.

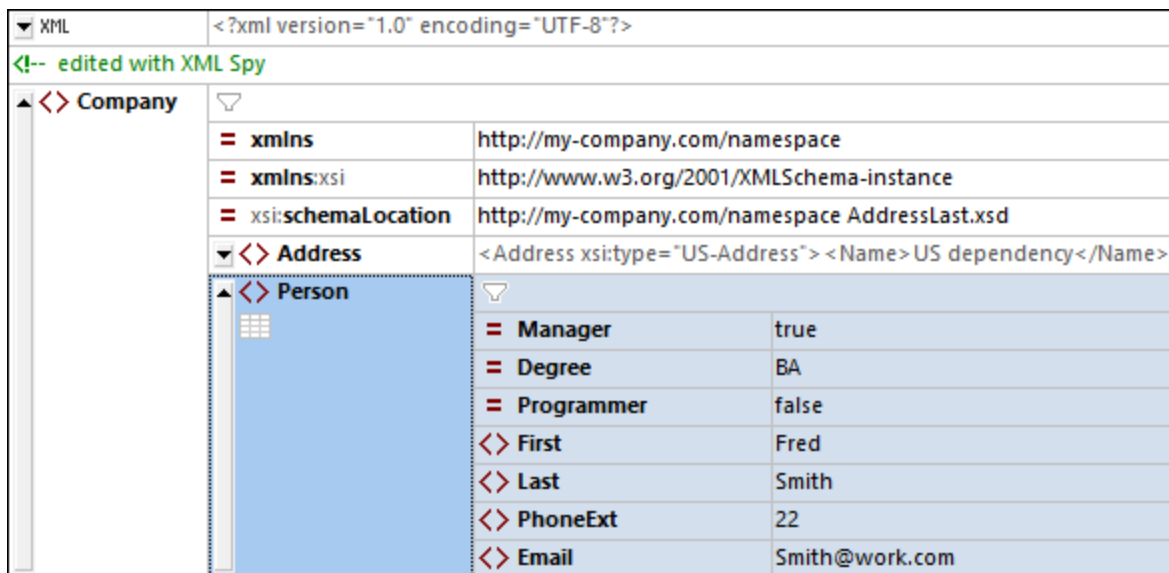

3. Select the `Person` element in the Siblings entry helper and click either **Insert After** or **Append**. A new `Person` element is appended (*screenshot below*).

Person <1>	
= Manager	true
= Degree	BA
= Programmer	false
<> First	Fred
<> Last	Smith
<> PhoneExt	22
<> Email	Smith@work.com

Person <2>	

4. When the `Person` element is selected, you will see, in the Children entry helper, this element's available child attributes and elements. Double-click attributes and elements to add the same child nodes as for the first `Person` element. When the focus in the Main Window changes from the `Person` element to an added child element, you can add additional children of the `Person` element in one of two ways: (i) Switch focus to the `Person` element (by selecting it) and adding a new child from the Children entry helper; (ii) With the focus on the added child element, add a sibling child element from the Siblings entry helper. In both entry helpers, child nodes of `Person` that have already been added will be grayed out.

Person <1>	
= Manager	true
= Degree	BA
= Programmer	false
<> First	Fred
<> Last	Smith
<> PhoneExt	22
<> Email	Smith@work.com

Person <2>	
= Manager	
= Degree	
= Programmer	
<> First	
<> Last	
<> PhoneExt	
<> Email	

You could enter content for the child nodes of the `Person` element in normal Grid View, but let's switch to the Table Display of Grid View since it is more suited to editing a structure with multiple occurrences, such as `Person`.

2.5.7 Editing in Table Display

Grid View contains a special view called Table Display, which is convenient for editing elements that have multiple occurrences. For example, the `Person` element has multiple occurrences (see *screenshot below*), so it can be displayed as a table. To display such an element as a table, click the **Table Display** icon of the first occurrence of the element. For example, in the screenshot below, the **Table Display** icon of the `Person` elements is circled in green. (Alternatively, select the menu command **XML | Display as Table** or the command's toolbar icon in the [Grid View toolbar](#)¹⁴⁷.)

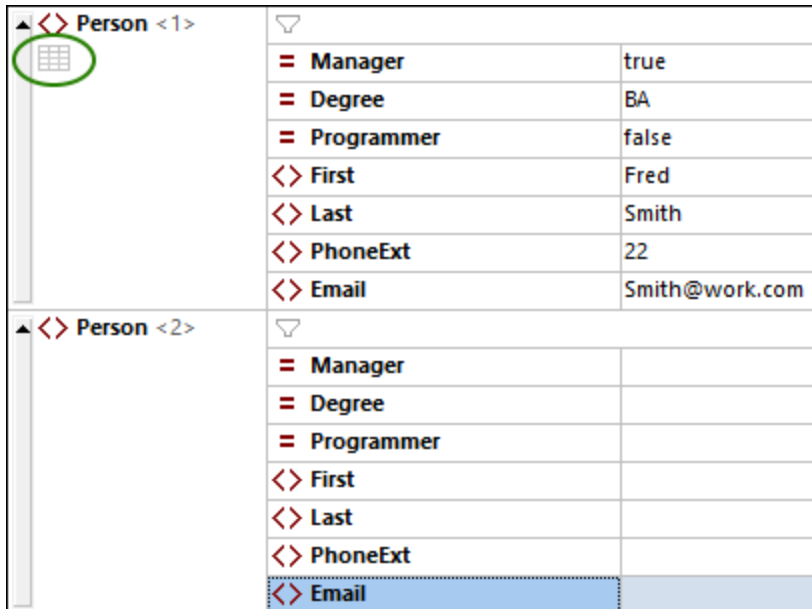

When you click the Table Display icon, the `Person` element will be displayed as a table. In Table Display, the child nodes of the element (its attributes and elements) are displayed as columns, while each `Person` element is displayed as a row (see *screenshot below*).

<> Person (2)	Manager	Degree	Programmer	First	Last	PhoneExt	Email
1	true	BA	false	Fred	Smith	22	Smith@work.com
2							

Advantages of Table Display

Table Display provides the following advantages:

- You can drag-and-drop a column header to reposition entire columns relative to each other. In the actual XML document, this translates to a change of the relative position of child nodes of all element occurrences (that correspond to the rows of the table).
- Tables—and, correspondingly, the element occurrences they represent—can be sorted (in ascending or descending order) according to the contents of any column. Use the menu command **XML | Ascending Sort** or **Descending Sort** for this.
- Additional rows (that is, element occurrences) can be appended or inserted quickly using commands in the **XML** menu. The advantage is that not only is a new element added but all its children that are represented by the columns of the table.
- You can copy-and-paste *structured data* to and from third party products, such as Microsoft Excel.
- The intelligent editing features of XMLSpy are available in Table Display also.

Displaying an element with multiple occurrences as a table

To display the `Person` element type as a table, do the following:

1. Click the **Table Display** icon of the first occurrence of the `Person` element as described above.
2. Select the menu option **View | Optimal Widths** or the **Optimal Widths** icon in the [Grid View toolbar](#) ⁽¹⁴⁷⁾.

Note: Table Display can be toggled on/off for all elements that have multiple occurrences. However, child elements that were displayed as tables will continue to be displayed as tables.

Entering content in Table Display

To enter content for the second `Person` element, double-click in each of the table cells in the second row, and enter some data. The intelligent editing features are active also within cells of a table, so you can select options from dropdown lists where available (for example, Boolean content and the enumerations of the `Degree` attribute).

	= Manager	= Degree	= Programmer	<> First	<> Last	<> PhoneExt	<> Email
1	true	BA	false	Fred	Smith	22	Smith@work.com
2	false	MA	true	Alfred	Aldrich	33	Aldrich@work.com

Dynamic validation

Note that, as defined in the schema, `PhoneExt` must be an integer from 0 to 99 in order for the file to be valid. You can toggle on XMLSpy's function to validate while editing. When switched on, the file is validated each time the focus switches to a new node. Try out dynamic validation as follows:

1. Toggle on the menu command **XML | Validate on Edit**.
2. Enter an invalid `PhoneExt` value (any value greater than 99), as shown in the screenshot below.
3. Press the **Tab** key. An error icon and a smart fix icon appear in the `PhoneExt` cell (see *screenshot below*).
4. Hover over the error icon to see the validation-error message (*screenshot below*).

<> Last	<> PhoneExt	<> Email
Smith	22	Smith@work.com
Aldrich	330	Aldrich@work.com

 Value '330' is not allowed for element <PhoneExt> .

5. Click the smart fix icon and then the smart fix option that pops up. The invalid value will be substituted with a valid value, and the error flag disappears.

Copying XML data to and from spreadsheet applications

When you are in Table Display, you can copy data as Tab-separated text so that it can be interchanged with spreadsheet applications such as MS Excel. To copy data from your XML file, do the following:

1. Click on the `Person` element (see screenshot below). This selects the column headers as well as both rows of the table.

<< Address		<Address xsi:type="US-Address"> <Name>US dependency</Name> <Street>Noble Ave.</Street> <City>Dallas</City>							
<< Person (2)		= Manager	= Degree	= Programmer	<> First	<> Last	<> PhoneExt	<> Email	
1		true	BA	false	Fred	Smith	22	Smith@work.com	
2		false	MA	true	Alfred	Aldrich	33	Aldrich@work	

2. Right-click inside the selection, and, in the context menu that appears, select the command **Copy | Copy as Tab-separated Text**. Alternatively, press **Ctrl+C**.
3. Switch to an Excel worksheet, select the cell A1 and paste (**Ctrl+V**) the XML data. The data will be entered as rows that correspond to the table structure in Table Display (see screenshot below).

	A	B	C	D	E	F	G	H
1	Manager	Degree	Programmer	First	Last	PhoneExt	Email	
2	TRUE	BA	FALSE	Fred	Smith	22	Smith@work.com	
3	FALSE	MA	TRUE	Alfred	Aldrich	33	Aldrich@work	
4								

4. Enter a new row of data in Excel as shown in the screenshot below. Make sure that you enter a three digit number for the `PhoneExt` element (say, 444).
5. Mark the table data in Excel, excluding the column headers (the green frame in the screenshot below), and copy it with **Ctrl+C**.

	A	B	C	D	E	F	G	H
1	Manager	Degree	Programmer	First	Last	PhoneExt	Email	
2	FALSE	MA	TRUE	Alfred	Aldrich	33	Aldrich@work	
3	TRUE	BA	FALSE	Fred	Smith	22	Smith@work.com	
4	TRUE	Ph.D	FALSE	Colin	Coletti	444	Coletti@work.com	
5								

6. In XMLSpy make sure that the **XML | Validate on Edit** command is toggled on.
7. In the Table Display of your XML document in XMLSpy, select the `Manager` cell of the first row and paste the clipboard contents with **Ctrl+V**. Your new table will look something like the screenshot below.

<< Address		<Address xsi:type="US-Address"> <Name>US dependency</Name> <Street>Noble Ave.</Street> <City>Dallas</City>							
<< Person (3)		= Manager	= Degree	= Programmer	<> First	<> Last	<> PhoneExt	<> Email	
1		FALSE	MA	TRUE	Alfred	Aldrich	33	Aldrich@work	
2		TRUE	BA	FALSE	Fred	Smith	22	Smith@work.com	
3		TRUE	Ph.D	FALSE	Colin	Coletti	444	Coletti@work.com	

8. The validation errors for the Boolean values have been caused by the casing difference between XML and Excel. To fix these, apply the smart fixes of the respective table cells.

Sorting the table on the contents of a column

A table in Table Display can be sorted, in ascending or descending order, on any of its columns. We want to sort the `Person` table on last name. Do this as follows:

1. Select the `Last` column by clicking its header.

	Manager	Degree	Programmer	First	Last	PhoneExt	Email
1	true	BA	false	Fred	Smith	22	Smith@work.com
2	false	MA	true	Alfred	Aldrich	33	Aldrich@work
3	true	Ph.D	false	Colin	Coletti	444	Coletti@work.com

2. Select the menu option **XML | Ascending Sort** or click the **Ascending Sort** icon in the [Grid View toolbar](#)¹⁴⁷. The column, and the whole table with it, is now sorted alphabetically. The column remains highlighted.

	Manager	Degree	Programmer	First	Last	PhoneExt	Email
1	false	MA	true	Alfred	Aldrich	33	Aldrich@work
2	true	Ph.D	false	Colin	Coletti	444	Coletti@work.com
3	true	BA	false	Fred	Smith	22	Smith@work.com

Since the phone extension 444 is correct but invalid, what we need to do is modify the XML Schema so that this number is valid. We will do this in the next section.

2.5.8 Modifying the Schema

Since we have a phone extension that is outside the range defined in the XML Schema (0 to 99), let's extend the range to 999. Do this as described below.

1. In Grid View, select any of the `PhoneExt` cells (see screenshot below).

	Manager	Degree	Programmer	First	Last	PhoneExt	Email
1	false	MA	true	Alfred	Aldrich	33	Aldrich@work
2	true	Ph.D	false	Colin	Coletti	444	Coletti@work.com
3	true	BA	false	Fred	Smith	22	Smith@work.com

2. Select the menu option **DTD/Schema | Go to definition** or click the **Go To Definition** icon in the [Grid View toolbar](#)¹⁴⁷. The associated schema, in this case `AddressLast.xsd`, is opened, and the `PhoneExt` definition will be highlighted (screenshot below).

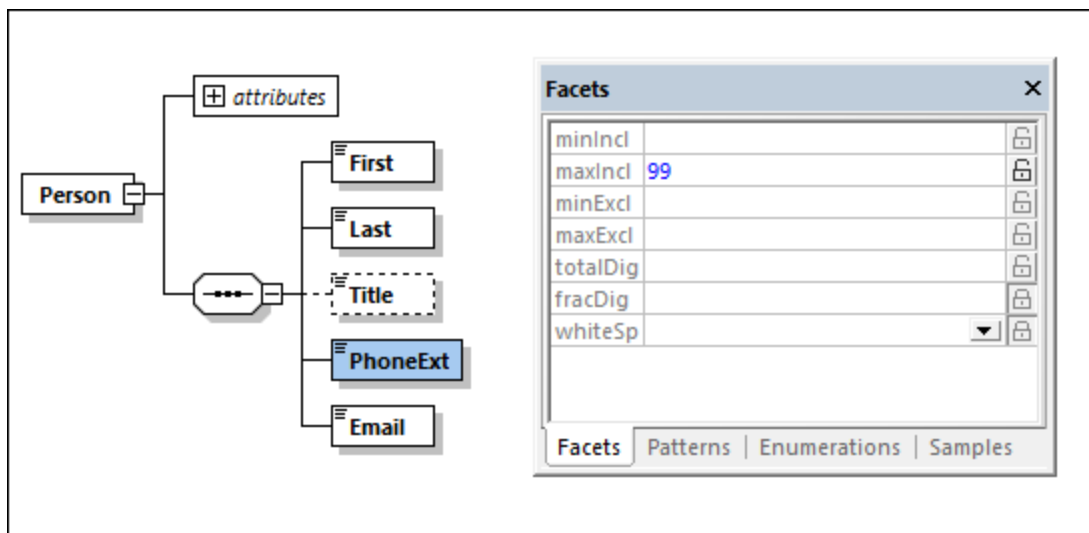

3. The element's `maxIncl` facet is `99` (see *screenshot*). Edit this value to `999`, and then save the schema.
4. Go back to the XML document and validate it. It will be valid.
5. Save your file as `CompanyLast.xml`.

Note: The Tutorial folder of XMLSpy contains a file named `companyLast.xml`, which contains the same data as the file you will have saved when you complete this tutorial.

2.6 XSLT Transformations

Objective

To generate an HTML file from the XML file using an XSL stylesheet to transform the XML file. You should note that a "transformation" does not change the XML file into anything else; instead a new output file is generated. The word "transformation" is a convention.



Method

The method used to carry out the transformation is as follows:

- Assign a predefined XSL file, `Company.xsl`, to the XML document.
- Execute the transformation within the XMLSpy interface using one of the two built-in Altova XSLT engines. (See note below.)

Commands used in this section

The following XMLSpy commands are used in this section:

	XSL/XQuery Assign XSL , which assigns an XSL file to the active XML document.
	XSL/XQuery Go to XSL , opens the XSL file referenced by the active XML document.
	XSL/XQuery XSL Transformation (F10) , or the toolbar icon, transforms the active XML document using the XSL stylesheet assigned to the XML file. If an XSL file has not been assigned then you will be prompted for one when you select this command.

Note: XMLSpy has built-in XSLT engines for XSLT 1.0, 2.0, and 3.0. The correct engine is automatically selected by XMLSpy on the basis of the version attribute in the `xmlns:stylesheet` or `xmlns:transform` element. In this tutorial, we use an XSLT 3.0 stylesheet, so the XSLT 3.0 Engine will be selected automatically when the **XSL Transformation** command is invoked.

2.6.1 Assigning an XSLT File

To assign an XSLT file to the `CompanyLast.xml` file:

1. Click the `CompanyLast.xml` tab in the main window so that `CompanyLast.xml` becomes the active document, and switch to Text View.
2. Select the menu command **XSL/XQuery | Assign XSL**.
3. Click the **Browse** button, and select the `Company.xsl` file from the Tutorial folder. In the dialog, you can activate the option *Make Path Relative to CompanyLast.xml* if you wish to make the path in the XML document relative.

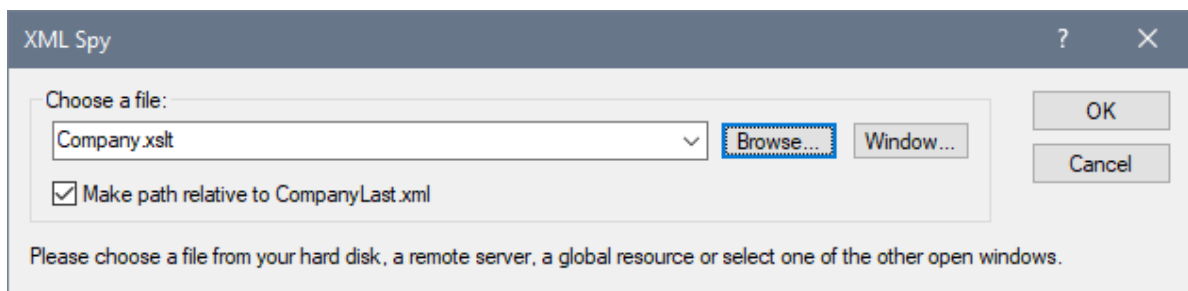

4. Click **OK** to assign the XSL file to the XML document.
5. Switch to Grid View to see the assignment (*screenshot below*). An XML-stYLESHEET processing instruction is inserted in the XML document that references the XSL file. If you activated the *Make Path Relative to CompanyLast.xml* check box, then the path is relative; otherwise it is absolute (as in the screenshot).

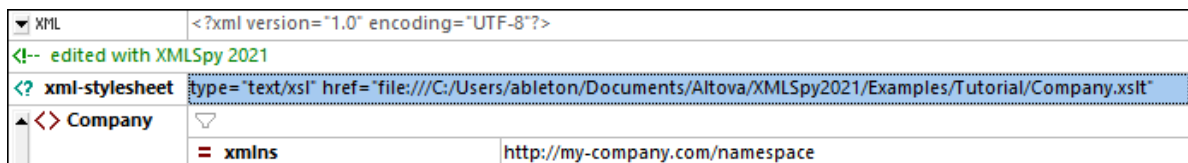

2.6.2 Transforming the XML File

To transform the XML document using the XSL file you have assigned to it:

1. Ensure that the XML file is the active document.
2. Select the menu option **XSL/XQuery | XSL Transformation (F10)** or click the command's icon in the toolbar. This starts the transformation using the XSLT stylesheet referenced in the XML document. The output document is displayed in Browser View; it has the name `xsl_output.html`. The HTML document shows the `Company/Address` data in one block on the left, and the `Company/Person` data in tabular form below.

Your Company

Name: US dependency
Street: Noble Ave.
City: Dallas
State: Texas
Zip: 04812

First	Last	Ext.	E-Mail	Manager	Degree	Programmer
Alfred	Aldrich	33	Aldrich@work	false	MA	true
Colin	Coletti	444	Coletti@work.com	true	Ph.D	false
Fred	Smith	22	Smith@work.com	true	BA	false

Note: Since the `company.xslt` file is an XSLT 3.0 document, the built-in Altova XSLT 3.0 Engine is automatically selected for the transformation. If the HTML output file is not generated, ensure that, in the XSL section of the Options dialog (**Tools | Options**), the default file extension of the output file has been set to `.html`. This ensures that the browser reads the output document correctly as an HTML file.

2.6.3 Modifying the XSL File

You can change the output by modifying the XSL document. For example, let's change the background-color of the table in the HTML output from `#ccccff` to `#99cc99`. Do this as follows:

1. Click the `companyLast.xml` tab to make this document the active document.
2. Select the menu option **XSL/XQuery | Go to XSL**. The command opens the `company.xslt` file that is referenced in the XML document.
3. Find the start tag of the `table` element and then the element's `bgcolor` attribute (*shown highlighted in the screenshot below*). Change the attribute's value from `#ccccff` to `#99cc99`.

```

6  <xsl:template match="/">
7  <html>
8      <head><title>Your company</title></head>
9      <body>
10         <h1><center>Your Company</center></h1>
11         <xsl:apply-templates select="//my:Address"/>
12         <table border="1" bgcolor="#ccccff">
13             <thead align="center">
14                 <td><strong>First</strong></td>
15                 <td><strong>Last</strong></td>
16                 <td><strong>Ext.</strong></td>
17                 <td><strong>E-Mail</strong></td>
18                 <td><strong>Manager</strong></td>
19                 <td><strong>Degree</strong></td>
20                 <td><strong>Programmer</strong></td>
21             </thead>
22             <xsl:apply-templates select="//my:Person"/>
23         </table>
24     </body>
25 </html>
26 </xsl:template>
27

```

4. Select the menu option **File | Save** to save the change.
5. Click the `companyLast.xml` tab to make the XML file active.
6. Run the menu command **XSL/XQuery | XSL Transformation**; alternatively, press **F10**. A new `xsl.output.html` file appears in Browser View, with a table that has the new background color (see screenshot below).

Your Company

Name: US dependency
Street: Noble Ave.
City: Dallas
State: Texas
Zip: 04812

First	Last	Ext.	E-Mail	Manager	Degree	Programmer
Alfred	Aldrich	33	Aldrich@work	false	MA	true
Colin	Coletti	444	Coletti@work.com	true	Ph.D	false
Fred	Smith	22	Smith@work.com	true	BA	false

7. Select the menu option **File | Save**, and save the output document as `Company.html`.

2.7 Project Management

This section introduces you to the project management features of XMLSpy. After first describing the benefits of organizing your XML files into projects, this section then shows you how to organize the files you have just created into a simple project.

2.7.1 Benefits of Projects

The benefits of organizing your XML files into projects are listed below.

- Files can be grouped into folders on some common criterion. For example, you could group XML files and XSD files into separate folders. You can create any hierarchy you like.
- Each folder has certain properties that you can set. For example, a folder of XML files can be assigned a schema for validation. All the files in this project folder can then be validated in a batch against the folder's schema file. If you change the project folder's schema assignment, then you can quickly run a new batch validation. You can set several other useful folder properties, such as an XSLT file for batch transformations with a single XSLT.
- Batch processing can be applied to specific folders or the project as a whole.
- A DTD or XML Schema can be assigned to specific folders, allowing validation of the files in that folder.
- XSLT files can be assigned to specific folders, allowing transformations of the XML files in that folder using the assigned XSLT.
- The destination folders of XSL transformation files can be specified for the folder as a whole.

All the above project settings can be defined using the menu option **Project | Properties**. Project commands are also available in context menus of the project and individual project folders. In the next section, you will create a project using the **Project** menu.

Additionally, the following advanced project features are available:

- XML files can be placed under source control using the menu option **Project | Source control | Add to source control**. (See the [Source Control section](#)⁸²⁷ for more information.)
- [External folders on your network](#)⁸⁴² as well [web folders](#)⁸⁴⁴ can be added to projects. This allows all the features of project folders, such as validation and transformations, to be applied to folders that are on your network or on the Internet.

2.7.2 Building a Project

Having come to this point in the tutorial, you will have a number of tutorial-related files open in the Main Window. You can group these files into a tutorial project. First you create a new project and then you add the tutorial files into the appropriate sub-folders of the project.

Create a new project

Create a new project as follows:

1. Select the menu option **Project | New Project**. A new project folder called **New Project** is created in the Project Window (*screenshot below*). The new project contains empty folders for typical categories of XML files.

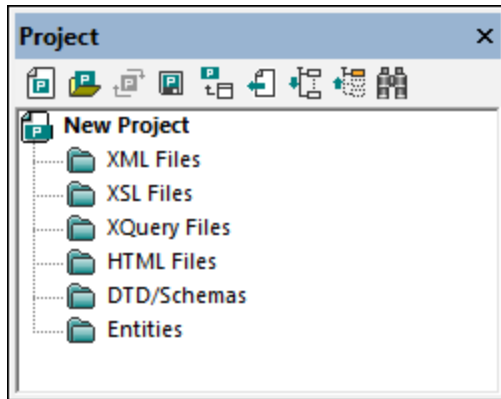

2. Click the `CompanyLast.xml` tab to make the `CompanyLast.xml` file the active file in the Main Window.
3. Select the menu option **Project | Add Active and Related Files** to project. Two files are added to the project: `CompanyLast.xml` and `AddressLast.xsd`. The XML file is added to the *XML* subfolder because it is the active file. The schema file is added to the *DTD/Schemas* folder because a reference to it is contained in the XML file, making it a related file. Note that files referenced with processing instructions, such as XSLT files, do not qualify as related files.
4. Select the menu option **Project | Save Project** and save the project under the name `Tutorial`.

Note: Folders (but not the project) each have a property named *File extensions*. This is a list of file extensions separated by semi-colons (for example, `xml;svg;wm1`). This list determines what files are added to which folders when files are added to a project. For example, when active and related files are added to a project, as done above, the *File extensions* properties of the folders determine into which folders the added files will be placed.

Project and folder properties

Properties (such as the schema for validation and the XSLT for transformation) can be set not only on the entire project, but also on individual folders. You can then carry out actions, such as validation and transformation, on the entire project or individual folders. To carry out an action, right-click the project or folder, and select the action you want to carry out from the context menu that appears.

Note the following points:

- A property that is set on a folder overrides the same property of the project.
- If a property is set on the project, it is applied to all folders that do not have the same property set.
- If an action is carried out on a project, it is applied to all applicable file types in all folders of the project. For example, if a validation is carried out on a project, the validation is run on all XML files in all folders of the project. In this case, the schema that has been set for the project is used for all validations, except for XML files that are in folders which have the schema validation property set to some other schema.

Adding files to the project

You can add other files to the project as well. Do this as follows:

1. Click on any open XML file (.xml file extension) other than `CompanyLast.xml` to make that XML file the active file. (If no other XML file is open, open one or create a new XML file.)
2. Select the menu option **Project | Add Active File to Project**. The XML file is added to the *XML Files* folder on the basis of its .xml file type.
3. In the same way, add an HTML file and XSD file (say, the `Company.html` and `AddressFirst.xsd` files) to the project. These files will be added to the *HTML Files* folder and *DTD/Schemas* folder, respectively.
4. Save the project, either by selecting the menu option **Project | Save Project**, or by selecting any file or folder in the Project Window and clicking the **Save** icon in the toolbar (or **File | Save**).

Note: Alternatively, you can right-click a project folder and select **Add Active File** to add the active file to that specific folder.

Other useful commands

Here are some other commonly used project commands:

- To add a new folder to a project, select **Project | Add Project Folder to Project**, and insert the name of the project folder.
- To delete a folder from a project, right-click the folder and select **Delete** from the context menu.
- To delete a file from a project, select the file and press the **Delete** key.

2.8 That's It

If you have come this far, congratulations and thank you!

We hope that this tutorial has been helpful in introducing you to the basics of XMLSpy and that you will now be able to carry out your XML work using XMLSpy as your editor. If you need more information about specific features, please use the Index or Search functions of this manual. Note that you can also print the PDF version of this tutorial. It is available as `Tutorial.pdf` in your XMLSpy [application folder](#) ²⁸.

3 GUI and Environment

This section describes:

- [The application GUI](#)¹⁰⁷, and
- [The application environment](#)¹²¹.

The [GUI section](#)¹⁰⁷ starts off by presenting an overview of the GUI and then goes on to describe each of the various GUI windows in detail. It also shows you how to re-size, move, and otherwise work with the windows and the GUI.

The [Application Environment section](#)¹²¹ points out the various settings that control how files are displayed and can be edited. It also explains how and where you can customize your application. In this section, you will learn where important example and tutorial files have been installed on your machine, and, later in the section, you are linked to the [Altova website](#), where you can explore the feature matrix of your application, learn about the multiple formats of your user manual, find out about the various support options available to you, and discover other products in the Altova range.

3.1 The Graphical User Interface (GUI)

The Graphical User Interface (GUI) consists of a Main Window and several sidebars (*see illustration below*). By default, the sidebars are located around the Main Window and are organized into the following groups:

- Project Window
- Info Window
- Entry Helpers: Elements, Attributes, Entities, etc (depending upon the type of document currently active)
- Output Windows: Messages, XPath/XQuery, XSL Outline, HTTP, Find in Files, Find in Schemas

The main window and sidebars are described in the sub-sections of this section.

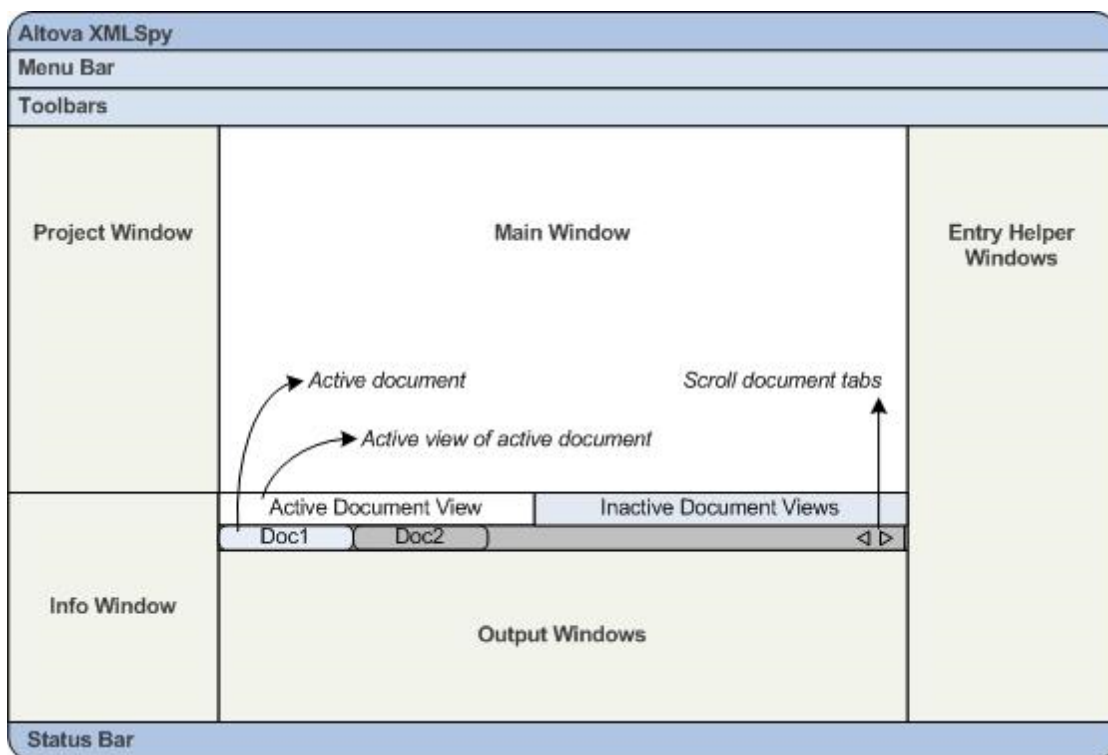

The GUI also contains a menu bar, status bar, and toolbars, all of which are described in the topic [Menu Bar](#), [Toolbars](#), [Status Bar](#) ¹¹⁹.

Switching on and off the display of sidebars

Sidebar groups (Project Window, Info Window, Entry Helpers, Output Windows) can be displayed or hidden by toggling them on and off via the commands in the **Window** menu. A displayed sidebar (or a group of tabbed sidebars) can also be hidden by right-clicking the title bar of the displayed sidebar (or tabbed-sidebar group) and selecting the command **Hide**.

If you close one of the Output Windows, you can get it back by clicking the menu command **Window | Output Windows**.

Floating and docking the sidebars

An individual sidebar window can either float free of the GUI or be docked within the GUI. When a floating window is docked, it docks into its last docked position. A window can also be docked as a tab within another window.

A window can be made to float or dock using one of the following methods:

- Right-click the title bar of a window and choose the required command (**Floating** or **Docking**).
- Double-click the title bar of the window. If docked, the window will now float. If floating, the window will now dock in the last position in which it was docked.
- Drag the window (using its title bar as a handle) out of its docked position so that it floats. Drag a floating window (by its title bar) to the location where it is to be docked. Two sets of blue arrows appear. The outer set of four arrows enables docking relative to the application window (along the top, right, bottom, or left edge of the GUI). The inner set of arrows enables docking relative to the window over which the cursor is currently placed. Dropping a dragged window on the button in the center of the inner set of arrows (or on the title bar of a window) docks the dragged window as a tabbed window within the window in which it is dropped.

To float a tabbed window, double-click its tab. To drag a tabbed window out of a group of tabbed windows, drag its tab.

Auto-hiding sidebars

The Auto-hide feature enables you to minimize docked sidebars to buttons along the edges of the application window. This gives you more screen space for the Main Window and other sidebars. Scrolling over a minimized sidebar rolls out that sidebar.

To auto-hide and restore sidebars click the drawing pin icon in the title bar of the sidebar window (or right-click the title bar and select **Auto-Hide**).

3.1.1 Main Window

The Main Window (*screenshot below*) is where you view and edit documents.

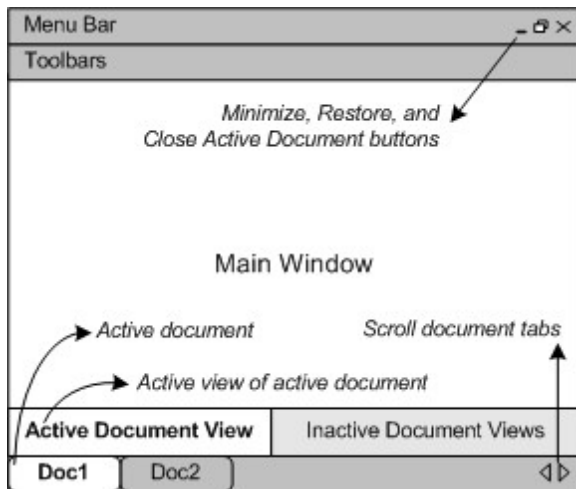

Files in the Main Window

- Any number of files can be opened and edited at once.
- Each open document has its own window and a tab (containing the document's file name) at the bottom of the Main Window. To make an open document active, click its tab.
- If several files are open, some document tabs might not be visible for lack of space in the document tabs bar. Document tabs can be brought into view by: (i) using the scroll buttons at the right of the document tab bar, or (ii) selecting the required document from the list at the bottom of the [Window](#)¹⁰⁸⁰ menu.
- When the active document is maximized, its **Minimize**, **Restore**, and **Close** buttons are located at the right side of the Menu Bar. When a document is cascaded, tiled, or minimized, the Maximize, Restore, and Close buttons are located in the title bar of the document window.
- When you maximize one file, all open files are maximized.
- Open files can be cascaded or tiled using commands in the [Window](#)¹⁰⁸⁰ menu.
- You can also activate open files in the sequence in which they were opened by using **Ctrl+Tab** or **Ctrl+F6**.
- Right-clicking a document tab opens a context-menu with a selection of File commands, such as **Print** and **Close**. Some useful commands: **Copy Full Path** copies the full path of the active file to the clipboard. **Open Containing Folder** opens the containing folder in Windows Explorer (so saving you the trouble of navigating to the folder). **Open Containing Archive** is available when the active file is inside a zipped archive; the archive will be opened in [Archive View](#)²⁷⁸.

Views in the Main Window

The active document can be displayed and edited in multiple views. The available views are displayed in a bar above the document tabs (see illustration above), and the active view is highlighted. A view is selected by clicking the required view button or by using the commands in the [View](#)⁹⁹¹ menu.

The available views are either editing or browser views:

- [Text View](#)¹³⁰: An editing view with syntax-coloring for working directly with document code.
- [Grid View](#)¹⁴⁶: For structured editing. The document is displayed as a structured grid that can be manipulated graphically. This view also contains a Table Display, which shows repeating elements in a tabular format.
- [Schema View](#)¹²⁶: For viewing and editing XML Schemas.

- [Authentic View](#)⁴⁵⁹: For editing XML documents that are based on StyleVision Power Stylesheets in a graphical interface.
- [Browser View](#)²⁷⁶: An integrated browser view that supports both CSS and XSL stylesheets.

Note: The default view for individual file extensions can be customized in the [Tools | Options](#)¹⁰⁴⁰ dialog: in the Default View pane of the File Types tab.

3.1.2 Project Window

A project is a collection of files that are related to each other in some way you determine. For example, in the screenshot below, a project named `Examples` collects the files for various examples in separate example folders, each of which can be further organized into sub-folders. Within the `Examples` project shown in the screenshot, for instance, the `Expense Report` folder is further organized into sub-folders for XML, XSL, and Schema files.

Note: The Project Window of XMLSpy will initially contain the application's default `Examples` project. To load the default `Examples` project, go to the application's `Examples` folder in the [\(My\) Documents folder](#)²⁸, and double-click the file `Examples.spp`.

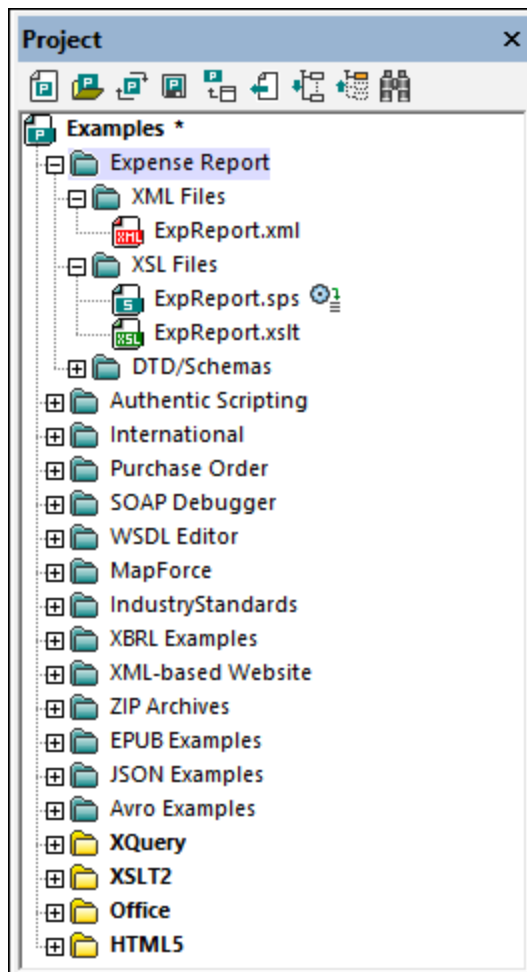

Projects thus enable you to gather together files that are used together and to access them quicker. Additionally, you can define schemas and XSLT files for individual folders, thus enabling the batch processing of files in a folder.

Project operations

Commands for folder operations are available in the **Project** menu, and some commands are available in the context menus of the project and its folders (right-click to access). A subset of **Project** menu commands, because they are frequently used, are also available in the toolbar of the Project Window (*screenshot below*).



The toolbar commands are, from left: *New Project*, *Open Project*, *Reload Project*, *Save Project*, *Add Active File to Project*, *Select Active File*, *Expand All*, *Collapse All*, *Find*. The names of these commands are self-explanatory and are explained in the [Project menu](#)⁸²³.

The key operations related to the Project Window are listed below.

- One project is open at a time in the Project Window. When a new project is created or an existing project opened, it replaces the project currently open in the Project Window.
- After changes have been made to a project, the project must be saved (by clicking the **Project | Save Project** command). A project with unsaved changes is indicated with an asterisk next to its name (see *screenshot above*).
- The project has a tree structure composed of folders, files, and other resources. Such resources can be added at any level and to an unlimited depth.
- Project folders are *semantic* folders that represent a logical grouping of files. They **do not need** to correspond to any hierarchical organization of files on your hard disk.
- Folders can correspond to, and have a direct relationship to, physical directories on your file system. We call such folders *external folders*, and they are indicated in the Project Window by a yellow folder icon (as opposed to normal project folders, which are green). External project folders must be explicitly synchronized by using the **Refresh** command.
- A folder can contain an arbitrary mix of file-types. Alternatively, you can define file-type extensions for each folder (in the Properties dialog of that folder) to keep common files in one convenient place. When a file is added to the parent folder, it is automatically added to the sub-folder that has been defined to contain files of that file extension.
- When you hover over an image file that has been placed in a project folder, a preview of the image is displayed (.png, .jpeg, .gif, .bmp, .tiff, and .ico formats). Double-click the image to open it in the system's default image viewer/editor program.
- In the Project Window, a folder can be dragged to another folder or to another location within the same folder, while a file can be dragged to another folder but cannot be moved within the same folder (within which files are arranged alphabetically). Additionally, files and folders can be dragged from Windows File Explorer to the Project Window.
- Each folder has a set of properties that are defined in the Properties dialog of that folder. These properties include file extensions for the folder, the schema by which to validate XML files, the XSLT file with which to transform XML files, etc.
- Batch processing of files in a folder is done by right-clicking the folder and selecting the relevant command from the context menu (for example, **Validate XML** or **Check Well-Formedness**).

For a more detailed description of projects, see the section [Projects](#)⁷¹⁴.

Note: The display of the Project Window can be turned on and off in the **Window** menu.

3.1.3 Info Window

The Info Window (*screenshot below*) shows information about the element or attribute in which the cursor is currently positioned. Information is available in the Info Window in Text View, Grid View, and Authentic View.

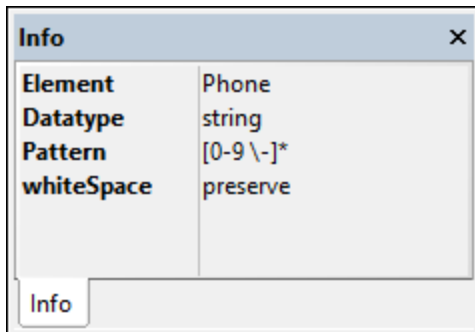

The display of the Info Window can be turned on and off in the **Window** menu.

Note the following points:

- When an XSLT document is active, additional XSLT-specific information and commands are available in the XSLT tab of the Info window. How to read the information and use the commands in the XSLT tab is explained in the section [XSLT and XQ | XSLT | XSL Outline](#)³⁶⁷.
- When a JSON document (instance or schema) is active, options for validation and intelligent editing are available in the JSON tab of the Info window. See [Validating JSON Documents](#)⁵⁶¹ for more information.

3.1.4 Entry Helpers

Entry helpers are an intelligent editing feature that helps you to create valid XML documents quickly. When you are editing a document, the entry helpers display structural editing options according to the current location of the cursor. The entry helpers get the required information from the underlying DTD, XML Schema, and/or StyleVision Power Stylesheet, etc. If, for example, you are editing an XML data document, then the elements, attributes, and entities that can be inserted at the current cursor position are displayed in the relevant entry helpers windows.

The entry helpers that are available depend upon:

1. *The kind of document being edited.* For example, XML documents will have different entry helpers than XQuery documents: elements, attributes, and entities entry helpers in the former case, but XQuery keywords, variables, and functions entry helpers in the latter case. The available entry helpers for each document type are described in this documentation in the description of that document type.
2. *The current view.* Since the editing mechanisms in the different views are different, the entry helpers are designed so as to be compatible with the editing mechanism of the current view. For example: In Text View, an element can only be inserted at the cursor location point, so the entry helper is designed to insert an element when the element is double-clicked. But in Grid View, an element can be inserted before the selected node, appended after it, or added as a child node, so the Elements entry helper in

Grid View has three tabs for *Insert*, *Append*, and *Add as Child*, with each tab containing the elements available for that particular operation.

A general description of entry helpers in each type of view is given in [Editing Views](#)¹²⁶. Further document-type-related differences within a view are noted in the description of the individual document types, for example [XML entry helpers](#)²⁹³ and [XQuery entry helpers](#)³⁷⁸.

Note the following:

- You can turn the display of entry helpers on or off with the menu option **Window | Entry Helpers**.
- In Visual Studio .NET, entry helper windows have a prefix that is the application name.

3.1.5 Output Window: Messages

The Messages Window displays messages about actions carried out in XMLSpy as well as errors and other output. For example, if an XML, XML Schema, DTD, or XQuery document is validated and is valid, a successful validation message (*screenshot below*) is displayed in the Messages Window:

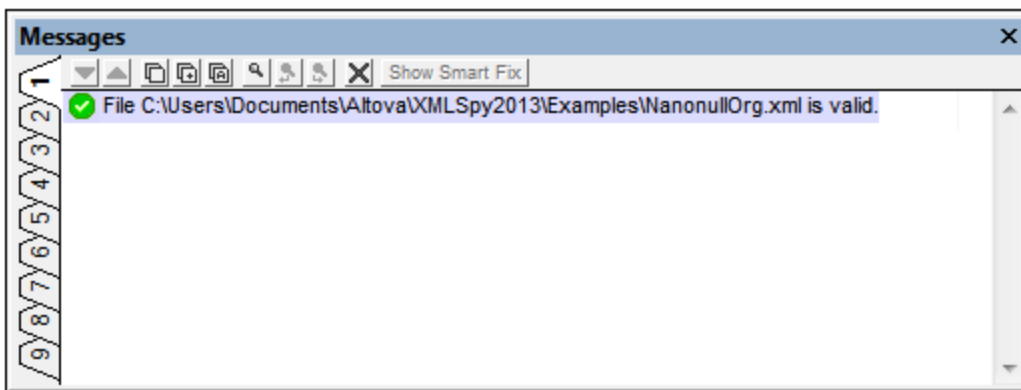

Otherwise, a message that describes the error (*screenshot below*) is displayed. Notice in the screenshot below that there are links (black link text) to nodes and node content in the XML document, as well as links (blue link text) to the sections in the relevant specification on the Internet that describe the rule in question. Clicking the purple `Def` buttons opens the relevant schema definition in Schema View.

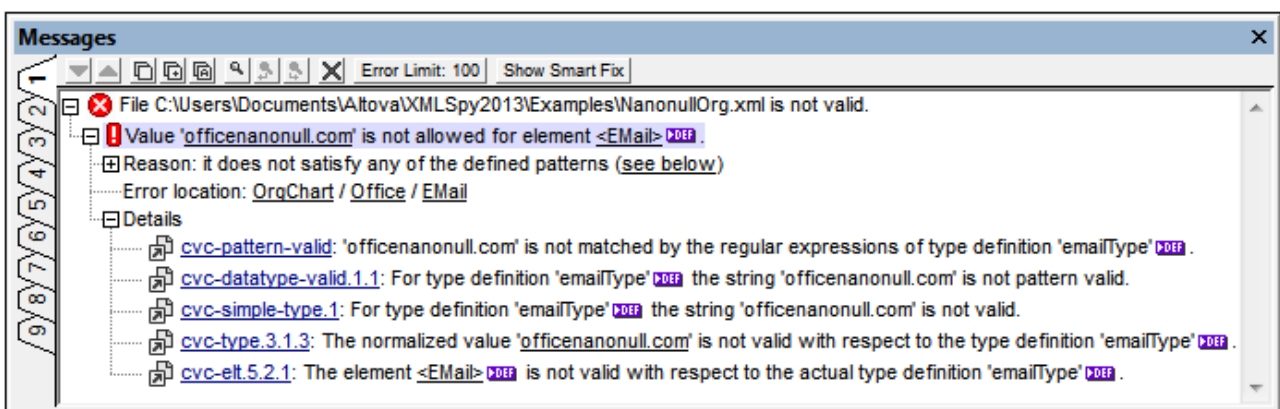

The Messages Window is enabled in all views, but clicking a link to content in an XML document highlights that node in the XML document in Text View. However, when an XML Schema has been validated in Schema View, clicking a `Def` button does not change the view.

XML Validation smart fixes

Based on information in the schema, options for a smart fix are also suggested if validation was carried out in **Text View or Grid View**. To view a list of smart fix options, click the **Show Smart Fix** button (see *screenshot above*). A pane with suggested smart fix options appears in the Messages window (*screenshot below*).

Note that errors in the Messages window are displayed one at a time. Also, errors of well-formedness (such as mismatched start and end tags), if such exist, are displayed prior to validation errors being displayed. So the **Show Smart Fix** button will be enabled only when a validation error is reached (after all well-formedness errors have been corrected).

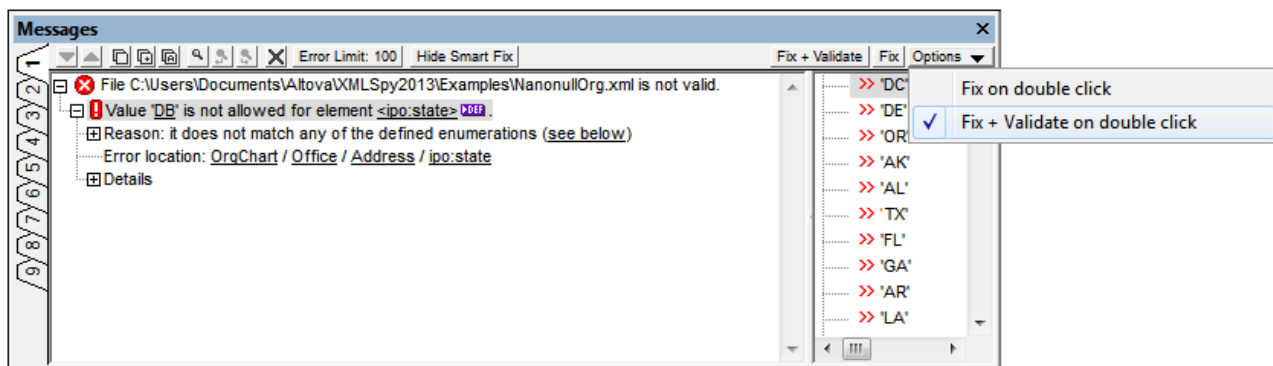

In the Smart Fix pane, select one of the suggested smart fixes and click either the **Fix + Validate** button or the **Fix** button (see *screenshot above*). The invalid text in the XML document will be replaced with the selected smart fix. Alternatively, you can double-click the smart fix you want. This action either fixes, or fixes and validates, according to the option selected in the dropdown *Options* list (see *screenshot above*). The **Fix + Validate** command is useful because when another validation is carried out after the fix it will pick up further validation errors if there are any.

To hide the Smart Fix pane, click the **Hide Smart Fix** button (see *screenshot above*). For more details, see the section [Editing Views | Schema View | Validation and Smart Fixes](#)²⁶².

Validating folders and files in the Project window

The **Validate** command (in the **XML** menu) is normally applied to the active document. But you can also apply the command to a file, folder, or group of files in the active project. Select the required file or folder in the Project Window (by clicking on it), and click [XML | Validate XML](#)⁸⁵⁷ or **F8**. Invalid files in a project will be opened and made active in the Main Window, and the *File is not valid* error message will be displayed.

Note: You can also carry out the well-formedness check ([Check Well-Formedness](#)⁸⁵⁶ or **F7**) in the Project window.

3.1.6 Output Window: XPath/XQuery

The XPath/XQuery Window (*screenshot below*) enables you to build, evaluate, and debug XPath and XQuery expressions with respect to XML or JSON documents. (Features that enable JSON queries were introduced in XPath/XQuery 3.1. See [JSON Transformations with XSLT/XQuery](#)⁵⁶⁵.)

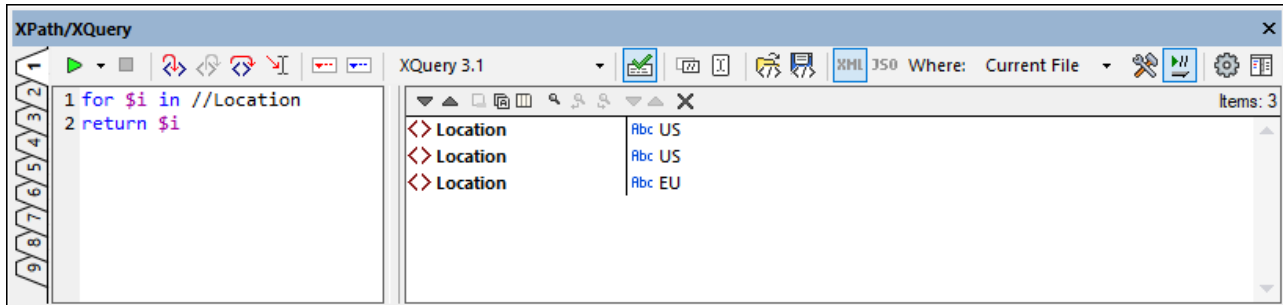

This section provides a brief overview of the main features of XPath/XQuery Window. For a detailed description of how to work with XPath/XQuery Window, see the section [XPath/XQuery Expressions](#)⁴¹⁹.

Main features

The XPath/XQuery Window provides the following main features:

- *Evaluation Mode:* In Evaluation Mode, an XPath or XQuery expression is evaluated with respect to one or more XML/JSON documents. The expression is entered in the Expression pane, and the result is displayed in the adjoining Results pane. You can click nodes in the result to go to that node in the XML or JSON document. See the section [XPath/XQuery Expressions](#)⁴¹⁹ for details.
- *Debug Mode:* In Debug Mode, you can debug an XPath/XQuery expression as it applies to the currently active XML document. You can set breakpoints and tracepoints, and go step-by-step through the evaluation. At each step you can see the content of variables, as well as set custom Watch expressions to check additional aspects of the evaluation. See the section [Debugging the Expression](#)⁴²⁸ for details.
- *Expression Builder:* An Expression Builder provides entry helpers and information popups to help you construct syntactically correct expressions. See the section [Expression Builder](#)⁴³⁶ for details.
- *Support for multiple languages:* You can switch language versions from XPath 1.0 to XPath 3.1 and XQuery 3.1. The expression that you enter will be evaluated according to the rules of the selected language.
- *Open and save expressions from/to file:* You can save an XPath/XQuery expression, together with the current settings of the window, to an XQuery file, and you can load expressions from an XQuery file.
- *Auto-detection of file type (XML/JSON):* The filetype of the current document (XML or JSON) is automatically detected and the correct target-document mode is automatically set. If the scope is a set of documents, you can manually select the target document type.
- *Flexible scope for target documents:* In the *Where* field, you can select whether the expression is tested on the currently active file, all open files, the current project, or a folder.
- *Options for the Result Window and Watch Window:* You can define how items in the Results Window and [Watch Expressions Window](#)⁴²⁸ are to be displayed.
- *Results link directly to documents and document nodes:* Lines in the Results pane contain links to the relevant documents or document nodes. This enables you to go directly to specific nodes and check data there.

- *Debugger analytics*: In Debug Mode, a wide range of analytical information is displayed. Additionally, you can set custom expressions to check additional aspects of the evaluation.

For a detailed description of the XPath/XQuery Window features, see the section [XPath/XQuery Expressions](#)⁴¹⁹, in which all the modes, icons, and functionality available in the toolbar are described..

3.1.7 Output Window: XSL Outline

The XSL Outline Window (*screenshot below*) lists all the templates and functions in an XSLT stylesheet, and, optionally, in all included and imported XSLT stylesheets as well. The XSL Outline Window is located by default docked with the Output Windows at the bottom of the XMLSpy window. It can be undocked, or docked along another edge of the XMLSpy window.

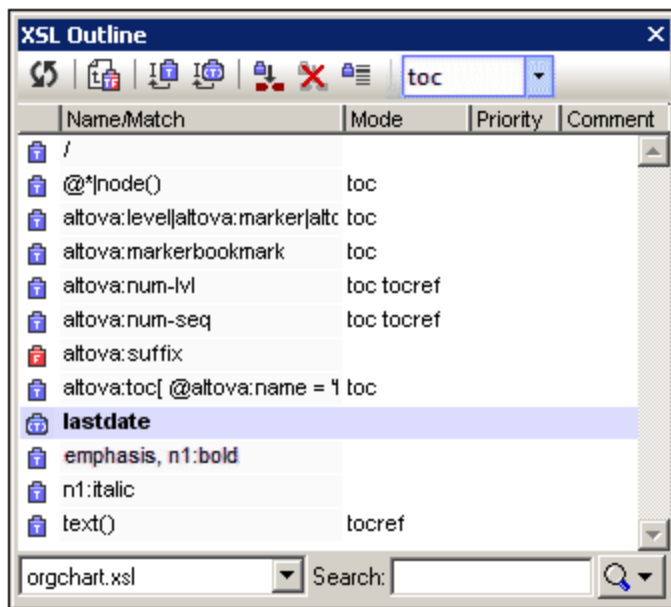

The XSL Outline Window provides information about templates and functions in the stylesheet. This information can be sorted and searched, and the window's toolbar contains commands that enable you to easily insert calls to named templates and to set named templates as the starting point of transformations. How to work with the XSL Outline Window is described in the section [XSLT and XQuery | XSLT | XSL Outline | XSL Outline Window](#)³⁶⁸.

Note: File-related information about the stylesheet and file-related commands are available in the XSLT tab of the Info Window. How to use these commands is described in the section [XSLT and XQuery | XSLT | XSL Outline | Info Window](#)³⁷¹.

3.1.8 Output Window: HTTP

in the HTTP output window (*screenshot below*), you can test HTTP commands: you can create and send an HTTP request to a web server, and receive and check the response.

The HTTP output window has nine tabs (see *screenshot below*). You can store a separate request in each tab, and switch between tabs. After creating a request in the window, you can send the request by clicking the **Send** button. The response is displayed directly in the window.

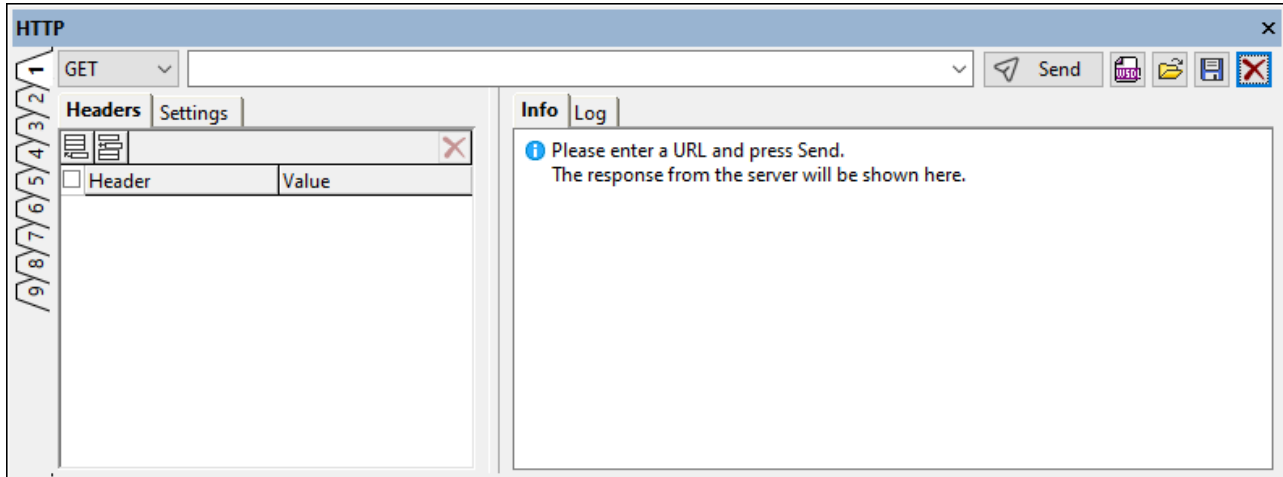

The window consists of the following parts:

- At the top: (i) a combo box in which to select the HTTP method you want to use; (ii) an entry field for the URL of the web server; (iii) buttons related to the execution of HTTP requests (**Send**, **Import**, and **Reset**).
- A left-hand pane for [creating the request](#) ⁵⁸⁴.
- A right-hand pane for displaying information and logging information about the request.

For details about how to use the HTTP output window, see the section [HTTP](#) ⁵⁸³.

3.1.9 Output Window: Find in Files

The Find in Files Window (*screenshot below*) enables you to carry out find-and-replace operations quickly within several documents at a time, and provides mechanisms that help you to quickly navigate among the found instances. The results of each find-and-replace action are presented in one of the tabs numbered 1 to 9. Clicking on a found item in the results takes you to that item in the Text View of that document.

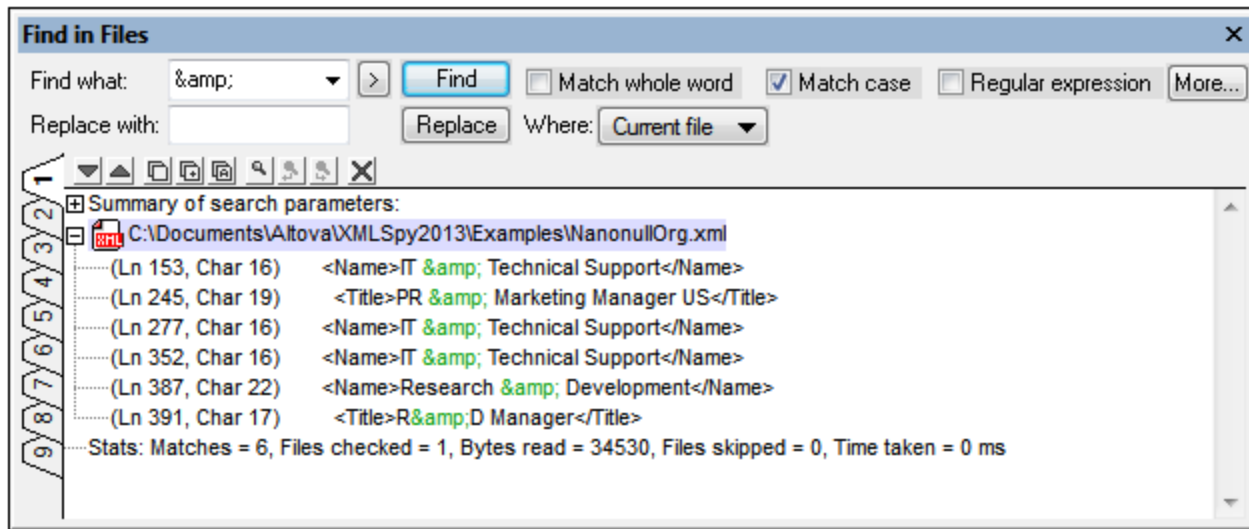

Find criteria

There are two broad find criteria: (i) what to find, and (ii) where to look?

What to find: The string to find is entered in the Find What text box. If that string must match a whole word, then the Match Whole Word check box must be clicked. For example, for the find string `fit`, with Match Whole Word checked, only the word `fit` will match the find string; the `fit` in `fitness`, for example, would not. You can specify whether casing is significant using the Match Case check box. If the text entered in the Find What text box is a regular expression, then the Regular Expression check box must be checked. An entry helper for regular expression characters can be accessed by clicking the  button. The use of regular expressions for searching is explained in the section, [Find](#)⁸¹². The **More** button opens the [Find in Files dialog](#)⁸¹⁹, where you can set advanced search conditions and actions. For more information, see [Edit | Find in Files](#)⁸¹⁹.

Where to look: The search can be conducted in: (i) all the files that are open in the GUI; (ii) the files of the current project; and (iii) the files of a selected folder. You can set additional conditions in the [Find in Files dialog](#)⁸¹⁹ (accessed by clicking **More**).

Replace with

The string with which the found string is to be replaced is entered in the Replace With text box. Note that if the Replace With text box is empty and you click the **Replace** button, the found text will be replaced by an empty string.

The results

After you click the **Find** or **Replace** buttons, the results of the find or replace are displayed in the Find in Files output window. The results are divided into four parts:

- A summary of the search parameters, which lists the search string and what files were searched.
- A listing of the found or replaced strings (according to whether the **Find** or **Replace** button was pressed). The items in this listing are links to the found/replaced text in the Text View of the document.

If the document is not open, it will be opened in Text View and the found/replaced text will be highlighted.

- A list of the files which were searched but in which no matches were found.
- A summary of statistics for the search action, including the number of matches and number of files checked.

Note: Note that the Find in Files feature executes the **Find** and the **Replace** commands on multiple files at once and displays the results in the Find in Files output window. To do a find so that you go from one found item to the next, use the [Find](#)⁸¹² command.

3.1.10 Output Window: Find in Schemas

When an XML Schema is active in Schema View, it can be searched intelligently using XMLSpy's Find and Replace in Schema View feature. The Find and Replace in Schema View feature is accessed via: (i) the **Find** and **Replace** commands in the **Edit** menu; and (ii) the **Find** and **Replace** buttons in the Find in Schemas Window (screenshot below).

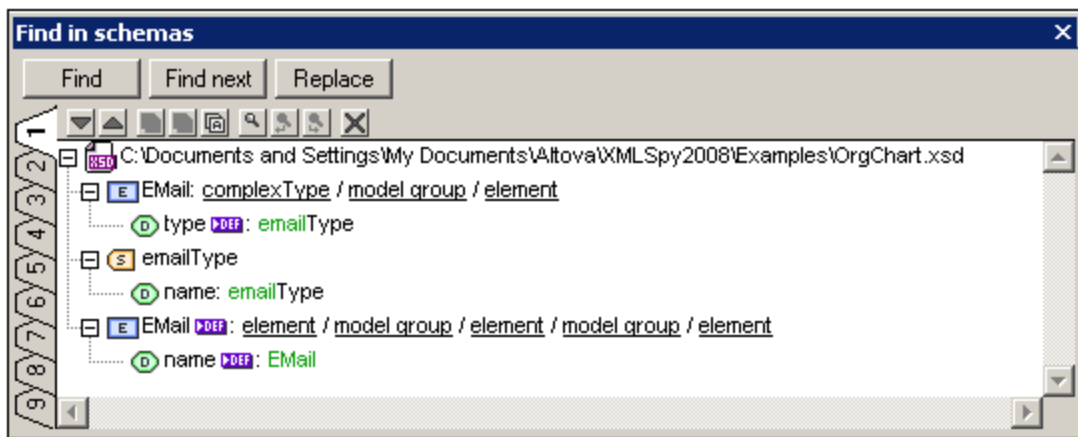

The results of the Find and Replace in Schema View feature (i.e. each time a Find or Replace command is executed) are displayed in the Find in Schemas window. The term that was searched for is displayed in green; (in the screenshot above, it can be seen that `email` was the search term, with no case restriction specified). Notice that the location of the schema file is also given.

Results are displayed in nine separate tabs (numbered 1 to 9). So you can keep the results of one search in one tab, do a new search in a new tab, and compare results. To show the results of a new search in a new tab, select the new tab before starting the search. Clicking on a result in the Find In Schemas window pops up and highlights the relevant component in the Main Window of Schema View. In this way you can search and navigate quickly to the desired component, as well as copy messages to the clipboard. For more details, see the [Results and Information](#)³⁵⁹ section in the description of the [Find in Schemas](#)³⁴⁸ feature.

3.1.11 Menu Bar, Toolbars, Status Bar

Menu Bar

The menu bar ([see illustration](#)¹⁰⁷) contains the various application menus. The following conventions apply:

- If commands in a menu are **not** applicable in a view or at a particular location in the document, they are unavailable.
- Some menu commands pop up a submenu with a list of additional options. Menu commands with submenus are indicated with a right-pointing arrowhead to the right of the command name.
- Some menu commands pop up a dialog that prompts you for further information required to carry out the selected command. Such commands are indicated with an ellipsis (...) after the name of the command.
- To access a menu command, click the menu name and then the command. If a submenu is indicated for a menu item, the submenu opens when you mouseover the menu item. Click the required sub-menu item.
- A menu can be opened from the keyboard by pressing the appropriate key combination. The key combination for each menu is **Alt+KEY**, where **KEY** is the underlined letter in the menu name. For example, the key combination for the **E**ile menu is **Alt+F**.
- A menu command (that is, a command in a menu) can be selected by sequentially selecting (i) the menu with its key combination (see previous point), and then (ii) the key combination for the specific command (**Alt+KEY**, where **KEY** is the underlined letter in the command name). For example, to create a new file (**E**ile | **N**ew), press **Alt+F** and then **Alt+N**.
- Some menu commands can be selected **directly** by pressing a special **shortcut** key or key combination (**Ctrl+KEY**). Commands which have shortcuts associated with them are indicated with the shortcut key or key combination listed to the right of the command. For example, you can use the shortcut key combination **Ctrl+N** to create a new file; the shortcut key **F8** to validate an XML file. You can [create your own shortcuts](#)¹⁰²⁷ in the Keyboard tab of the Customize dialog (**T**ools | **C**ustomize).

Toolbars

The toolbars ([see illustration](#)¹⁰⁷) contain icons that are shortcuts for selecting menu commands. The name of the command appears when you place your mouse pointer over the icon. To execute the command, click the icon.

Toolbar buttons are arranged in groups. In the [Tools | Customize | Toolbars](#)¹⁰²⁴ dialog, you can specify which toolbar groups are to be displayed. These settings apply to the current view. To make a setting for another view, change to that view and then make the setting in the [Tools | Customize | Toolbars](#)¹⁰²⁴. In the GUI, you can also drag toolbar groups by their handles (or title bars) to alternative locations on the screen. Double-clicking the handle causes the toolbar to undock and to float; double-clicking its title bar causes the toolbar to dock at its previous location.

Status Bar

The Status Bar is located at the bottom of the application window ([see illustration](#)¹⁰⁷) and displays (i) status information about the loading of files, and (ii) information about menu commands and command shortcuts in the toolbars when the mouse cursor is placed over these. If you are using the 64-bit version of XMLSpy, this is indicated in the status bar with the suffix (x64) after the application name. There is no suffix for the 32-bit version.

3.2 The Application Environment

In this section we describe various aspects of the application that are important for getting started. Reading through this section will help you familiarize yourself with XMLSpy and get you off to a confident start. It contains important information about settings and customization, which you should read for a general idea of the range of settings and customization options available to you and how these can be changed.

This section is organized as follows:

- [Settings and Customization](#)¹²¹: Describes how and where important settings and customization options can be defined.
- [Tutorials, Projects, Examples](#)¹²⁴: Notes the location of the various non-program files included in the application package.
- [Product features and documentation, and Altova products](#)¹²⁴: Provides links to the [Altova website](#), where you can find information about product features, additional Help formats, and other Altova products.

3.2.1 Settings and Customization

In XMLSpy, there are several settings and customization options that you can select. In this section, we point you to these options and also briefly discuss some aspects of XMLSpy menus. This section is organized into the following parts.

- [Settings](#)¹²¹
- [Customization](#)¹²²
- [Menus](#)¹²³

Settings

Several important XMLSpy settings are defined in different tabs in the Options dialog (*screenshot below*, accessed via the menu command [Tools | Options](#)¹⁰⁴⁶). You should look through the various options to familiarize yourself with what's available.

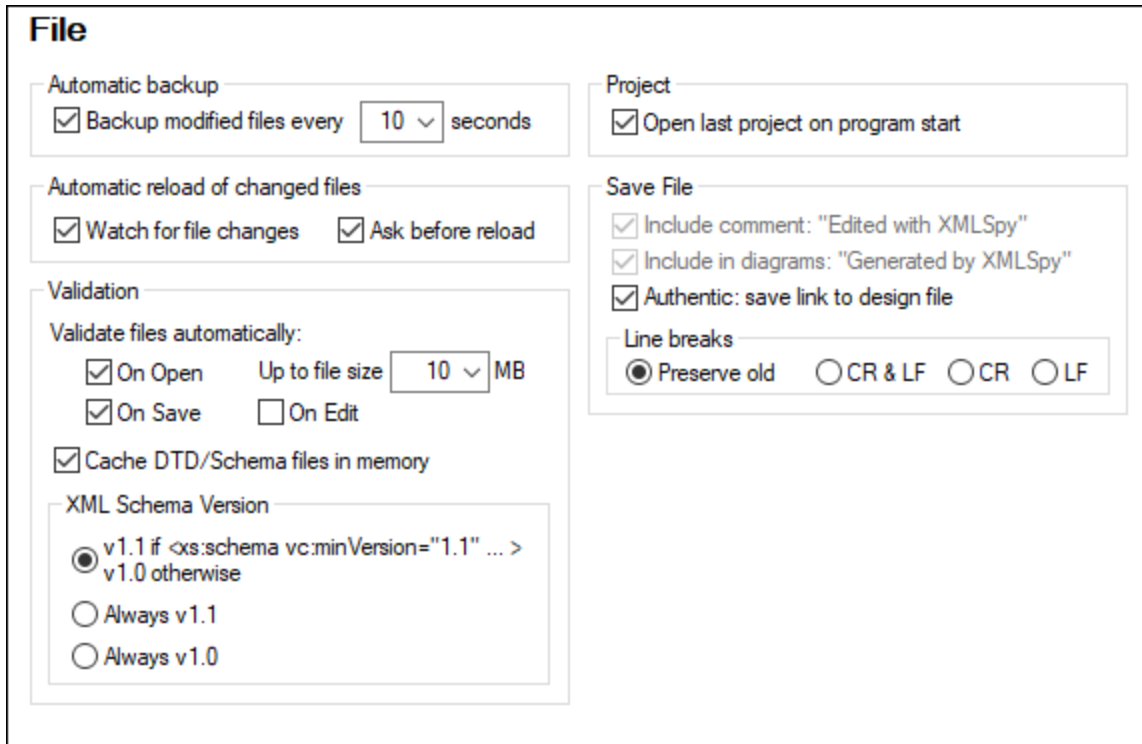

Given below is a summary of the most important settings. For details, see the description of the [Options dialog](#)¹⁰⁴⁰ in the User Reference section.

- **File types and default views:** In the File Types tab, you can add file types that XMLSpy will recognize. A file type is specified by a file extension. For each file type, you can then specify conformance to a particular standard (for example conformance to the DTD, XQuery, or JSON standard). This setting will switch on editing aids relevant to the standard selected for a particular file type. You can also specify in what XMLSpy view files of each file type should open (the default view for this file type).
- **File validation:** In the File tab (*screenshot above*), you can specify whether files should be validated automatically on opening and/or saving. In the File Types tab (*see previous bullet point*), file validation can then be disabled for specific file types.
- **Editing features:** In the Editing tab, you can specify how entry helpers should be organized, how new elements are generated, and whether auto-completion is enabled. Additional options are available for individual views in the View tab. In the Fonts tabs for various views, you can specify the font characteristics of individual node types in each of these views.
- **XSLT and FO Engines:** In the XSL tab, you can specify that an external XSL engine be used for transformations made from within the GUI. You must also specify the location of the FO processor executable to be used for FO processing within XMLSpy. For more information, see the [XSLT Processing](#)³⁶⁵ section.
- **Encoding:** Default encodings for XML and non-XML files are specified in the Encoding tab.

Customization

You can also customize various aspects of XMLSpy, including the appearance of the GUI. These customization options are available in the Customize dialog (*screenshot below*, accessed via the menu command [Tools | Customize](#)¹⁰²²).

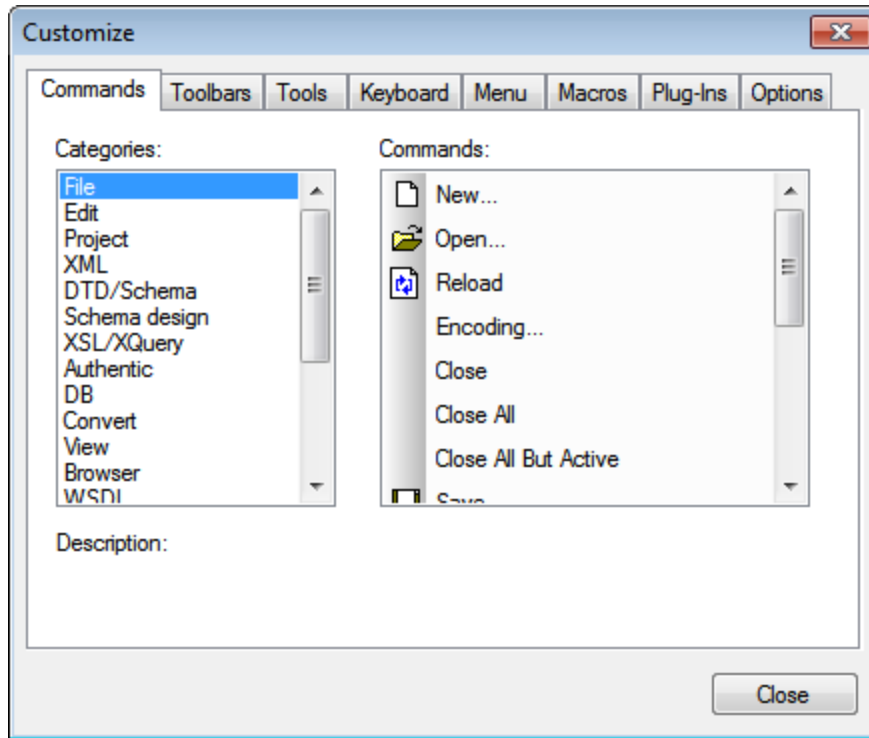

The various customization options are described in the [User Reference](#)¹⁰²² section.

Menus

Menu commands are enabled/disabled depending upon three factors: (i) file type, (ii) active view, and (iii) current cursor location or current document status. For example:

- *File type:* The command **DTD/Schema | Include Another DTD** is enabled only when the active file is a DTD. Similarly, commands in the **WSDL** menu will be enabled only when a WSDL file is active.
- *Active view:* Most commands in the **Schema Design** menu will be active only when the active view is Schema View.
- *Current cursor location, document status:* In Grid View, whether the command to add an attribute as a child node (**XML | Add Child | Attribute**) is enabled will depend on whether the selected item in Grid View is an element or not (*current cursor location*). When an XSLT document is active the **Stop Debugger** command will not be active till after a debugger session has been started (*current document status*).

Note also that you can customize menus ([Tools | Options](#)¹⁰⁴⁰) as well as drag and reorganize them within the GUI (see [Menu Bar, Toolbars, Status Bar](#)¹¹⁹).

3.2.2 Tutorials, Projects, Examples

The XMLSpy installation package contains tutorials, projects, and example files.

Location of tutorials, projects, and example files

The XMLSpy tutorials, projects, and example files are installed in the folder:

```
C:\Users\\Documents\Altova\XMLSpy2024\Examples\
```

The `My Documents\Altova\XMLSpy2024` folder will be installed for each user registered on a PC within that user's `<username>` folder. Under this installation system, therefore, each user will have his or her own `Examples` folder in a separate working area.

Location of tutorial, project, and examples files

All tutorial, project, and example files are located in the `Examples` folder. Specific locations are as follows:

- XMLSpy tutorial: `Tutorial` folder.
- Authentic View tutorial: `Examples` folder.
- WSDL tutorial: `Examples` folder.
- Project file: The `Examples` project with which XMLSpy opens is defined in `Examples.spp`, which is located in the `Examples` folder.
- Example files: are in the `Examples` folder and in sub-folders of the `Examples` folder.

3.2.3 XMLSpy Features and Help, and Altova Products

The Altova website, www.altova.com, has a wealth of XMLSpy-related information and resources. Among these are the following.

XMLSpy feature listing

The Altova website carries an [up-to-date list of XMLSpy features](#), which also compares the support of various features across XMLSpy editions (Enterprise and Professional). On the website, you can also obtain a listing of features that are new since any previous release.

XMLSpy Help

This documentation is the Altova-supplied Help for XMLSpy. It is available as the built-in Help system of XMLSpy, which is accessible via the **Help** menu or by pressing **F1**. Additionally, the user manuals for all Altova products are available in the following formats:

- [Online HTML manuals](#), accessed via the Support page at the Altova website
- [Printable PDFs](#), which you can download from the Altova website and print locally
- [Printed books](#) that you can buy via a link at the Altova website

Support options

If you require additional information to what is available in the user manual (this documentation) or have a query about Altova products, visit our [Support Center](#) at the Altova website. Here you will find:

- Links to our [FAQ pages](#)
- [Discussion forums](#) on Altova products and general XML subjects
- [Online Support Forms](#) that enable you to make support requests, should you have a support package. Your support request will be processed by our support team.

Altova products

For a list of all Altova products, see the [Altova website](#).

4 Editing Views

XMLSpy contains powerful editing views. In addition to a Text View with intelligent editing features, there are graphical views that greatly simplify the editing of documents. Depending on what type of document is currently active in XMLSpy, the Main Window will have one or more of XMLSpy's Editing Views. For example, when an HTML document is active, the Main Window will contain two editing views: Text View and Browser View. When an XML document is active, there will be five editing views: Text View, Grid View, Schema View, Authentic View, and Browser View. Of these views, Schema View will be enabled only for XML Schema documents.

In this section, we describe the various editing views available in XMLSpy:

- [Text View](#)¹³⁰
- [Grid View](#)¹⁴⁶
- [Schema View](#)¹⁹⁸
- [Authentic View](#)⁴⁵⁹
- [Browser View](#)²⁷⁶

Default view selection

A document of a specific type (for example, an XML document or JSON document) can be viewed in multiple views. You can select the default editing view directly in the interface, by either clicking or right-clicking the current view's tab and selecting the appropriate option from the menu that appears (see *screenshot below*; note that *WSDL View and XBRL View are available in the Enterprise edition only*):

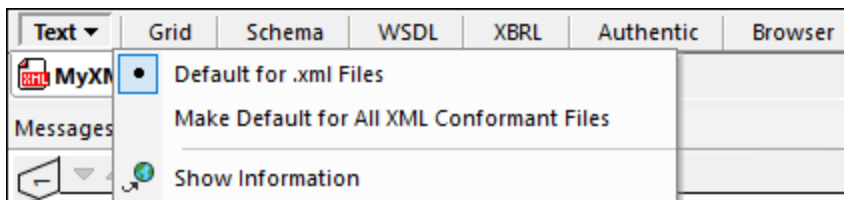

The menu options are:

- *Default for file extension*: The current editing view becomes the default view for files having the **same file extension** as the active file (for example, `.xml` files or `.xq` files).
- *Default for all similarly conformant files*: The current editing view becomes the default view for files having the **same conformance type** as the active file (for example, all XML-conformant files or all XQuery-conformant files). This could be a larger set than the set for a file extension; for example, the two different file extensions `.xq` and `.xquery` could both be XQuery-conformant.
- *Show information*: Links to a page on the [Altova website](#) that describes the features of the current editing view.

If a default view option has been selected, then it will have a radio button next to it (see *screenshot above*).

In the following cases, no change of default editing view is possible

- *JSON Schema files*: These files, like JSON instance files, have a `.json` extension. However, they will be automatically detected from content to be JSON Schemas, and will always be opened in [JSON Schema View](#)⁵²³.

- *Authentic-enabled XML files:* These are XML files (having a `.xm1` file extension) that have been assigned an Altova StyleVision Stylesheet, which enables the XML document to be viewed as an Authentic XML document. These files will always be opened in [Authentic View](#)²⁷⁵.

Note: The file conformance of each file extension, as well as the default editing view that corresponds to individual file types, can be set in the [File Types section of the Options dialog](#)¹⁰⁴³. However, the default view selection in the editing view itself (which has been described here) gives you the option of setting default views faster and in an easier way.

4.1 Automatic Backup of Files

Files that are modified in XMLSpy are automatically backed up at regular intervals. In the *File* tab of the Options dialog ([Tools | Options | File](#) ¹⁰⁴¹) shown in the screenshot below, you can:

- Switch on/off automatic backups
- Specify the frequency of backups (5 seconds to 300 seconds)

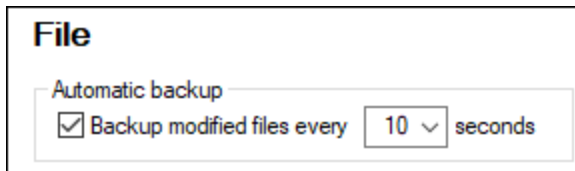

All file types that can be edited in XMLSpy will be backed up; ZIP archives are not backed up.

Indicators

The file tabs at the bottom of the Main Window contain symbols to the right of the file name which indicate the saved/unsaved state and backup state of the file (*screenshot below*).

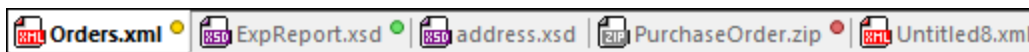

Saved / Unsaved

A colored circle symbol is present if a file has been modified. If no such symbol is present, it means that the file has not been modified since either being opened or being last saved. In the screenshot above, for example, `address.xsd` has not been modified since being last saved, and `Untitled8.xml` is a new file that has not been edited or saved since it was created.

Backup state

The colors of the circle symbols indicate the backup state of the file.

- **Yellow:** The file has been modified, but the last modification has not been backed up (or saved).
- **Green:** The file has been backed up, and it has not been modified since being backed up. However, the file has not been saved. (If it had been saved, there would be no circle symbol.)
- **Red:** Backup is not supported for this file (for example, if this is the [Archive View](#) ²⁷⁸ of a ZIP file) or a backup has failed.
- **Gray:** The automatic backup function has been disabled (via the [Options dialog](#) ¹⁰⁴¹; see above). The presence of the symbol, however, indicates that the file has not been saved since last modification. (If it had been saved, there would be no circle symbol.)

Restoring from backups

If XMLSpy terminates unexpectedly, then, at the next application start, a Restore Document dialog is displayed which contains a list of all documents that were open at the time of the application being terminated (*screenshot below*). You can hover over each file to see its path. In the case of temporary files that have not yet been saved, the filepath will be the current default path were a Save As dialog opened for that file.

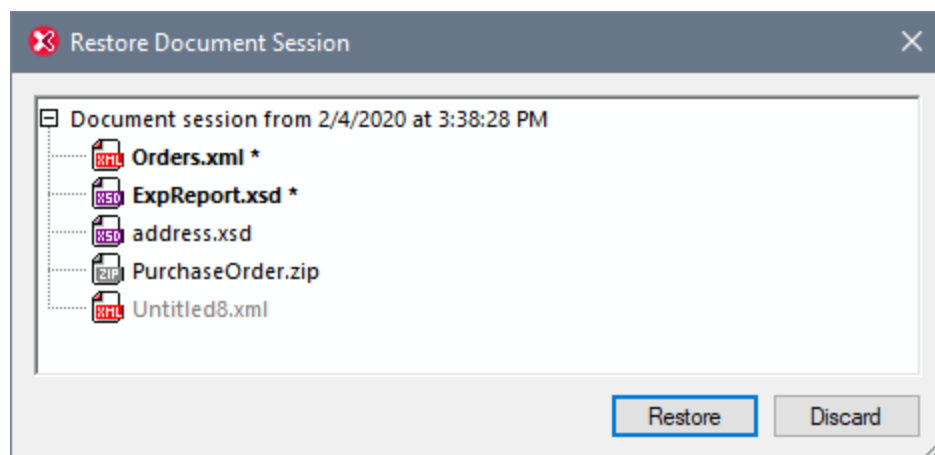

For each file in the list, its font style and the presence/absence of asterisks provide the following information:

- A bold style and asterisk indicates that the file contains unsaved changes. Such files will be restored in their last backed-up state.
- A normal style indicates that the file has been saved and there are no unsaved changes. Such files will be restored in their saved state.
- A grayed out style indicates that the file has neither been saved nor been backed up (for example, because it is a new file that was not edited). Such files will not be restored.

You can now do one of the following:

- Click **Restore** to restore the files in the GUI from their last backed-up state.
- Click **Discard** to not open any of the listed files and to discard any available backups.

4.2 Text View

In Text View (*screenshot below*), you can type in the text of your document—both, markup and content—directly. Any text file, including non-XML documents (such as XQuery and HTML documents) can be edited in Text View. A number of features help you to quickly and accurately type in your document.

```

<Office>
  <Name>Nanonull, Inc.</Name>
  <Desc>...</Desc>
  <Location>US</Location>
  <Address>
    <ipo:street>119 Oakstreet, Suite 4876</ipo:street>
    <ipo:city>Vereno</ipo:city>
    <ipo:state>DC</ipo:state>
    <ipo:zip>29213</ipo:zip>
  </Address>
  <Phone>+1 (321) 555 5155 0</Phone>
  <Fax>+1 (321) 555 5155 4</Fax>
  <EMail>office@nanonull.com</EMail>
  <Department>
    <Name>Administration</Name>
    <Person>
      <First>Vernon</First>
      <Last>Callaby</Last>
      <Title>Office Manager</Title>
      <PhoneExt>582</PhoneExt>
      <EMail>v.callaby@nanonull.com</EMail>
      <Shares>1500</Shares>
      <LeaveTotal>25</LeaveTotal>
      <LeaveUsed>4</LeaveUsed>
      <LeaveLeft>21</LeaveLeft>
    </Person>
  </Department>
</Office>

```

In this section, we describe general Text View features that are available for all kinds of documents. Specific document types, such as XML, XQuery, and CSS have certain type-specific features, which are described in the respective sections for those document types. For example, additional XML-specific features of Text View are described in the section [XML | Editing XML in Text View](#)²⁸⁷.

The general Text View features have been organized as follows:

- [Formatting in Text View](#)¹³¹ describes how the font properties, indentation, and word-wrapping of the document can be specified.
- [Displaying the Document](#)¹³³ contains information about the line-numbering, bookmarking, expanding/collapsing of nodes, and other display-related features.
- [Editing in Text View](#)¹³⁶ describes the features that are available while you edit, particularly the intelligent editing features.
- [Navigating the Document](#)¹³⁹ explains the various ways in which you can navigate a document in Text View.
- [Entry helpers](#)¹⁴² are the windows that provide context-sensitive data-entry options. For example, the elements or attributes that can be validly added at a given document location are displayed in an entry helper and any one of these options can be inserted by double-clicking it.

- [Split View](#)¹⁴³ divides the main window of Text View in two and displays the active document in both views. This enables you to see different parts of a long document side-by-side.
- [Text View Shortcuts](#)¹⁴⁴ lists the default shortcuts of commonly used Text View commands.

Switching to Text View

To open the Text View of a document, click the **Text** button at the bottom of the Document Window or select **View | Text View**.

Switching from Text View to Browser View

If in Text View a document is marked up in HTML or [Markdown](#)²⁷⁶ formatting and you switch to [Browser View](#)²⁷⁶, then the document will be rendered in [Browser View](#)²⁷⁶ as an HTML page.

4.2.1 Formatting in Text View

Text View offers a number of text formatting options. These are listed below.

Fonts

The font-family, font-size, font-style, and text background-color can be customized separately for the following groups of documents: (i) generic XML documents (including HTML); (ii) XQuery documents; and (iii) CSS documents.

Text items in a document that have different semantics, can be colored differently. For example, you can color element names, attribute names, and element content differently. When you set different colors for different text items, the syntax-coloring feature is enabled. Text fonts are customized in the [Fonts and Colors section of the Options dialog](#)¹⁰⁶¹.

Indentation

You can indent a document to show its structure, as in the screenshot below. When the document is shown with this kind of hierarchical indentation, it is said to be pretty-printed. In a pretty-printed document, each deeper level will be displayed with a deeper indent than its parent element. To see a document in its pretty-printed form, you must: (i) set up its indentation (according to your preference) and (ii) apply pretty-printing to it.

```

<Office>
  <Name>Nanonull, Inc.</Name>
  <Desc>...</Desc>
  <Location>US</Location>
  <Address>
    <ipo:street>119 Oakstreet, Suite 4876</ipo:street>
    <ipo:city>Vereno</ipo:city>
    <ipo:state>DC</ipo:state>
    <ipo:zip>29213</ipo:zip>
  </Address>
  <Phone>+1 (321) 555 5155 0</Phone>
  <Fax>+1 (321) 555 5155 4</Fax>
  <EMail>office@nanonull.com</EMail>
  <Department>
    <Name>Administration</Name>
    <Person>
      <First>Vernon</First>
      <Last>Callaby</Last>
      <Title>Office Manager</Title>
      <PhoneExt>582</PhoneExt>
      <EMail>v.callaby@nanonull.com</EMail>
      <Shares>1500</Shares>
      <LeaveTotal>25</LeaveTotal>
      <LeaveUsed>4</LeaveUsed>
      <LeaveLeft>21</LeaveLeft>
    </Person>
  </Department>
</Office>

```

To set up and apply pretty-printing, carry out the following steps. Note that the set up of pretty-printing is application-wide. This means that pretty-printing settings will be applied to all XML and JSON documents after the settings have been saved. Consequently, settings need to be edited only when you want to change the pretty-printing display of your documents. Once the application-wide settings have been made, you must apply pretty-printing individually to each document. A document is always displayed with the pretty-printing that was applied to it, and its display formatting will not change till the next time pretty-printing is applied.

1. In the [Pretty-printing section](#)¹⁰⁴⁸ of the Options dialog ([Tools | Options](#)¹⁰⁴⁰), enable pretty-printing by checking the option *Use indentation determined by the tab configuration of Text View*. It is this setting that switches on the indentation that you will see in a pretty-printed document. If the *Use Indentation* option is not checked, then every line in the document will start with a zero indent.
2. While still in the [Pretty-printing section](#)¹⁰⁴⁸ (see *previous point*), click the **Text View Settings** button (at top right) to go to the Text View Settings dialog (*screenshot below*) and set the amount and type of indentation. (Alternative ways to access the Text View Settings dialog are (i) the menu command [View | Text View Settings](#)⁹⁹⁵ and (ii) the **Text View Settings** icon in the Text toolbar.) In the Text View Settings dialog, the *Tab size* field specifies the number of spaces that make up a tab as well as an indent. Choose whether pretty-printing indents will be composed of tabs or spaces by selecting either *Insert Tabs* or *Insert Spaces*. In either case, the size of each indent will be equivalent to the *x* number of spaces specified in the *Tab size* field (since 1 tab = X spaces).

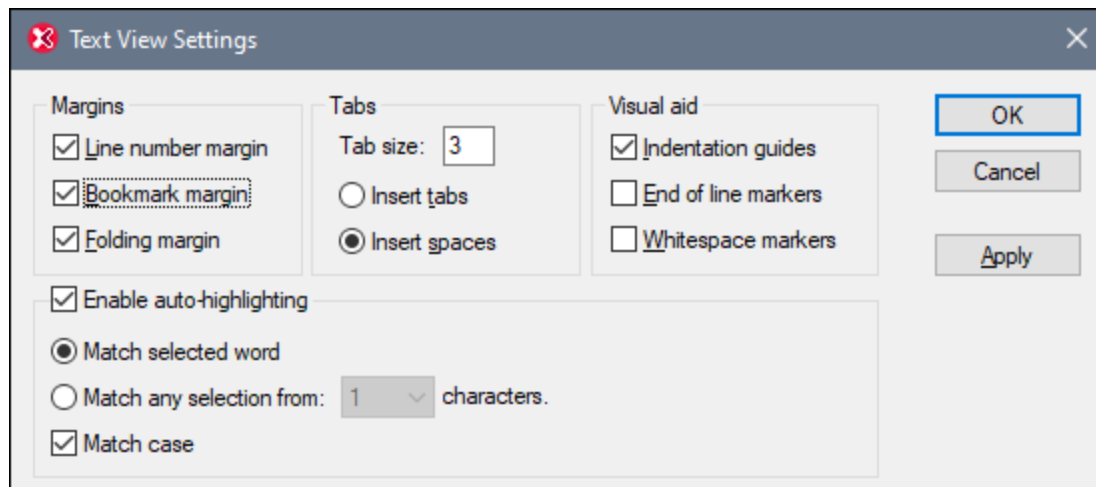

- After having set up application-wide pretty-printing as described in the previous two steps, you can apply pretty-printing to individual documents. Make the document you want to pretty-print the active document. Click the [Edit | Pretty-Print](#) ⁸¹² command or the **Pretty Print** icon in the Text toolbar. This will cause the document text to be displayed according to the formatting specified in the [Pretty Printing](#) ¹⁰⁴⁸ section of the Options dialog. Note that the **Pretty-Print** command removes unnecessary leading or trailing whitespace.

Note: Indentation guides are vertical dotted lines (see screenshot at the start of this section). They are toggled on and off via the Indentation Guides check box in the Visual Aid pane of the Text View Settings dialog (see screenshot above).

Note: For information about whitespace handling, see the section [Whitespace](#) ²⁹⁶.

Using tabs and spaces for formatting

You can use tabs and spaces for formatting text, especially for non-XML documents, where the pretty-printing option is not available. When you press **Return** or **Shift+Return**, the cursor will jump to a position on the next line that corresponds to the starting position of the previous line.

Word-wrapping

Lines of text that are longer than the breadth of the Main Window can be made to wrap by toggling the [View | Word Wrap](#) ⁹⁹⁴ command on; the corresponding icon is in the [Text toolbar](#) ¹³³.

4.2.2 Displaying the Document

Text View has visual features to make the display and editing of large sections of text easier. Some very useful features are: (i) [Line Numbers](#) ¹³⁴, (ii) [Bookmarks](#) ¹³⁴, (iii) [Source Folding](#) ¹³⁴ (expanding and collapsing the display of nodes), (iv) [Indentation Guides](#) ¹³⁵, and (v) [End-of-Line and Whitespace Markers](#) ¹³⁵. These commands are available in the Text View Settings dialog (first screenshot below) and the Text toolbar (second screenshot below).

The [Text View Settings dialog](#)⁹⁹⁵ is accessed via the **View | Text View Settings** command, the **Text View Settings** button in the Text toolbar, or the Text View context menu. Settings in the Text View Settings dialog apply to the entire application—not only to the active document.

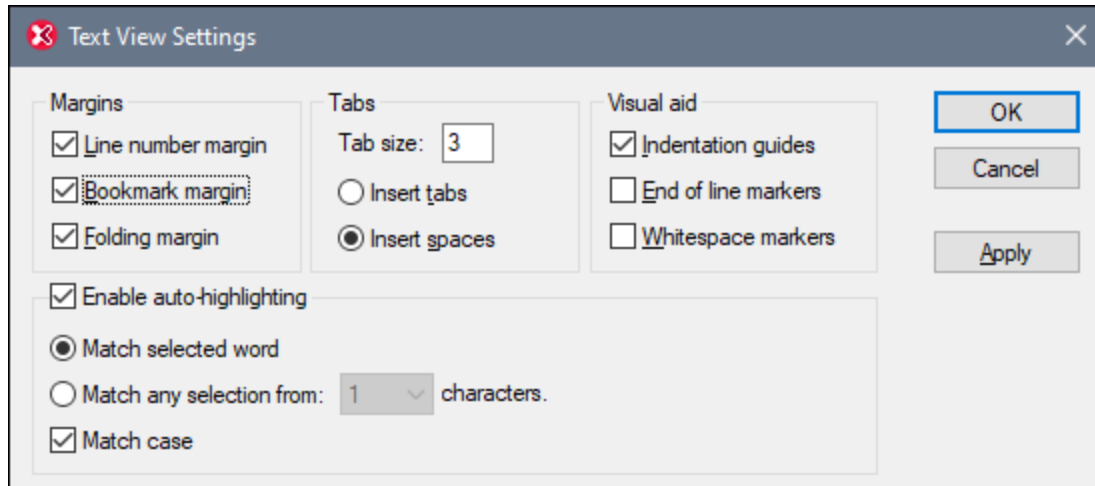

Other useful features are the [Zooming](#)¹³⁶ and [navigation and search](#)¹³⁹ features.

Line numbers

Line numbers are displayed in the line numbers margin (*screenshot below*), which can be toggled on and off in the Text View Settings dialog (see screenshot above). When a section of text is collapsed, the line numbers of the collapsed text are also hidden. A related command is the [Go-to-Line/Character](#)¹⁴² command.

Bookmarks

Lines in the document can be separately bookmarked for quick reference and access. If the bookmarks margin is toggled on, bookmarks are displayed in the bookmarks margin; otherwise, bookmarked lines are highlighted in cyan.

The bookmarks margin can be toggled on or off in the Text View Settings dialog (*screenshot above*).

You can edit and navigate bookmarks using commands in the **Edit** menu and Text toolbar. Bookmarks can be inserted with the **Edit | Insert/Remove Bookmark** command, enabling you to mark a line in the document for reference. A bookmark can be removed by selecting the bookmarked line and then selecting the **Edit | Insert/Remove Bookmark** command. To navigate through the bookmarks in a document, use the **Edit | Next Bookmark** and **Edit | Previous Bookmark** commands. These bookmark commands are also available as icons in the Text toolbar (*screenshot above*).

Source folding

Source folding refers to the ability to expand and collapse nodes in XML, XQuery, JSON, and CSS documents. Nodes that can be expanded/collapsed are indicated in the source folding margin by a +/- sign (see *screenshot below*). The margin can be toggled on and off in the Text View Settings dialog (see *screenshot*

above). In the screenshot below, notice that three nodes have been collapsed: the `shipTo` element and two `item` elements. When a node is collapsed, this is visually indicated by an ellipsis (*marked in green in the screenshot below*). If the mouse cursor is placed over an ellipse, the content of the collapsed node is displayed in a popup (*marked in blue in the screenshot below*). If the content is too large for a popup, this is indicated by an ellipsis at the bottom of the popup.



The **Toggle All Folds** icon  in the Text toolbar toggles **all** nodes to their expanded forms or collapses all nodes to the top-level document element.

The following options are available when clicking on the node's +/- icon:

Click [-]	Collapses the node.
Click [+]	Expands the node so that descendant nodes are shown expanded or collapsed according to how they were before the node was collapsed.
Shift+Click [-]	Collapses all descendant nodes, but leaves the node that was clicked in its expanded form.
Ctrl+Click [+]	Expand the clicked node as well as all its descendant nodes.

Indentation guides

Indentation guides are vertical dotted lines that indicate the extent of a line's indentation (*see screenshot above*). They can be toggled on and off in the Text View Settings dialog.

End-of-line markers, whitespace markers

End-of-line (EOL) markers and whitespace markers can be toggled on in the Text View Settings dialog. The screenshot below shows these markers in the document display; each dot represents a whitespace.

```
5 ...<CompanyLogo href="nanonull.gif"/>EOL
6 ...<Name>Organization.Chart</Name>EOL
7 ...<Office>EOL
8 .....<Name>Nanonull, .Inc.</Name>EOL
9 .....<Desc>EOL
```

Zooming in and out

You can zoom in and out of Text View by turning the scroll-wheel of the mouse while keeping the **Ctrl** key pressed. This enables you to magnify and reduce the size of text in Text View. If you wish to increase the size of fonts, do this in the [Options dialog](#)¹³¹.

4.2.3 Editing in Text View

The following text editing features are available in Text View generally for all document types. These features are in addition to common features of editing applications, such as **Cut**, **Copy**, **Paste**, **Delete**, and **Select All** (which are available as commands in the **Edit** menu).

- [Syntax coloring](#)¹³⁶
- [Start-tag and end-tag matching](#)¹³⁸
- [Intelligent editing](#)¹³⁶
- [Auto-completion](#)¹³⁷
- [Moving siblings relative to each other](#)¹³⁸
- [Selecting an entire element and going to parent](#)¹³⁸
- [Find and Replace](#)¹³⁸
- [Drag-and-drop and context menus](#)¹³⁹
- [Unlimited undo](#)¹³⁹
- [Spelling check](#)¹³⁹

For some document types (such as [XML](#)²⁸² and [XQuery](#)³⁷⁴) additional specialized features are available, and these are described, respectively, in the sections that deal with those document types.

Note: For large files, Auto-completion and entry helpers can be disabled, thus enabling faster loading and editing. The threshold file size is specified by the user. For more details, see the reference section [Options | Editing](#)¹⁰⁴⁷.

Syntax coloring

Syntax coloring is applied according to the semantic value of the text. For example, in XML documents, depending on whether the XML node is an element, attribute, content, CDATA section, comment, or processing instruction, the node name (and in some cases the node's content) is colored differently. A number of document type are distinguished, such as: (i) generic XML (which includes HTML); (ii) XQuery; (iii) CSS; and (iv) JSON. The text properties (including color) of each group can be set in the Text Fonts section of the Options dialog (**Tools | Options**).

Intelligent Editing

If you are working with an XML document based on a schema, XMLSpy provides you with various intelligent editing capabilities in Text View. These allow you to quickly insert the correct element, attribute, or attribute

value according to the content model defined for the element you are currently editing. For example, when you start typing the start tag of an element, the names of all the elements allowed by the schema at this point are shown in a pop-up (*screenshot below*). Selecting the required element name and pressing **Enter** inserts that element name in the start tag. Also, after the start tag is created, the end tag is automatically added (see [Auto-completion](#) ¹³⁷ *below*).

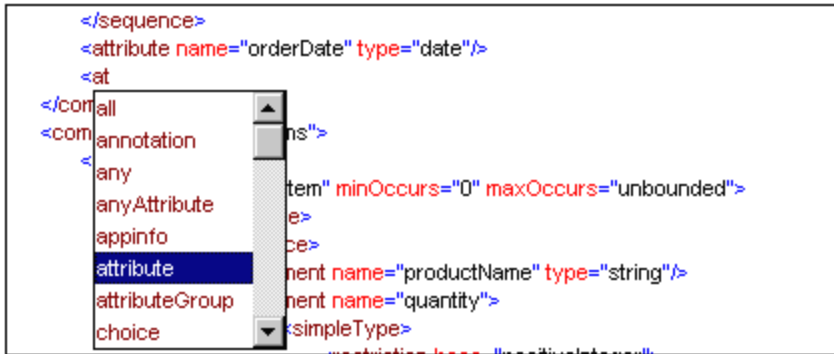

Popup windows also appears in the following cases:

- When the cursor is inside the start tag of an element that has an attribute defined for it and the space bar is pressed. The popup will contain all available attributes.
- When the cursor is within the double-quotes delimiting an attribute value that has enumerated values. The popup will contain the enumerated values.
- When you type `</` (which signifies the start of a closing tag), the name of the element to be closed appears in the popup.
- When you wish to write an empty element as a single tag or convert an empty element of two tags to an empty element of one tag, type in the closing slash after the element name: `<element/`. An empty element with a single tag is created; if a close tag exists, it is removed: `<element/>`.

Auto-completion

Editing in Text View can easily result in XML and other marked-up documents (such as HTML) that are not well-formed. For example, closing tags may be missing, mis-spelled, or structurally mismatched. XMLSpy automatically completes the start and end tags of elements, as well as inserts all required attributes as soon as you finish entering the element name on your keyboard. The cursor is also automatically positioned between the start and end tags of the element, so that you can immediately continue to add child elements or contents:

```
<img src="" alt=""> </img>
```

XMLSpy makes use of the XML rules for well-formedness and validity to support auto-completion. The information about the structure of the document is obtained from the schema on which the document is based. (In the case of well-used schemas, such as HTML and XSLT, the schema information is built into XMLSpy.) Auto-completion uses not only information about the structure of the document, but also the values stored in the document. For example, enumerations and schema annotations in an XML Schema are actively used by the Auto-Completion feature. If, in the schema, values are enumerated for a particular node, then those enumerations will be displayed as auto-completion options when that node comes to be edited. Similarly, if, for a node, annotations exist in the schema, then these annotations are displayed when the node name is being typed in the document (*screenshot below*). (*First (given) name of person* is the schema annotation of the `First` element.)

Drag-and-Drop and Context Menus

You can also use drag-and-drop to move a text block to a new location, as well as right-click to directly access frequently used editing commands (such as [Cut](#)⁸⁰⁴, [Copy](#)⁸⁰⁴, [Paste](#)⁸⁰⁴, [Delete](#)⁸⁰⁴, [Send by Mail](#)⁷⁹⁸, and [Go to line/char](#)⁹⁹⁵) in a context menu.

Unlimited Undo

XMLSpy offers unlimited levels of [Undo](#)⁸⁰⁴ and [Redo](#)⁸⁰⁴ for all editing operations.

Spelling check

In Text View, documents can be spellchecked with any of the built-in language dictionaries. A user dictionary can also be created and edited to allow words not contained in the language dictionary. For details, see the descriptions of the [Spelling](#)¹⁰⁰⁰ and [Spelling Options](#)¹⁰⁰³ commands.

4.2.4 Navigating the Document

You can use the following features to navigate a document in Text View:

- [Text highlighting](#)¹³⁹ enables you to find all matches of a text string or word that you select. Each match is indicated in the scroll bar, so you can navigate easily through all the matches.
- [Document overview in the scroll bar](#)¹⁴¹ shows you the relative location of the cursor and text selection within the document.
- [Go to line/character](#)¹⁴² takes you straightaway to the line and character you specify.

Text highlighting

If text highlighting is enabled in the Text View Settings dialog ([View | Text View Settings](#)⁹⁹⁵), then all matches in the document of a text selection that the user makes are highlighted. The selection will be highlighted in pale blue, and matches will be highlighted in pale orange (see *screenshot below*). The selection and its matches are indicated in the scroll bar by gray marker-squares. Note also that the current cursor position is given by the blue cursor-marker in the scroll bar.

```

4
5  <expense-report xmlns:xsi="http://www.w3.org/2001/XMLSchema-instance"
6     xsi:noNamespaceSchemaLocation="ExpReport.xsd" currency="USD" detailed="false"
7     total-sum="556.9">
8     <Person>
9       <First>Fred</First>
10      <Last>Landis</Last>
11      <Title>Project Manager</Title>
12      <Phone>123-456-7890</Phone>
13      <Email>f.landis@nanonull.com</Email>
14    </Person>
15    <expense-item type="Lodging" expto="Sales">
16      <Date>2003-01-01</Date>
17      <expense>122.11</expense>
18    </expense-item>
19    <expense-item type="Lodging" expto="Development">
20      <Date>2003-01-02</Date>
21      <expense>122.12</expense>
22      <description>Played penny arcade</description>
23    </expense-item>
24    <expense-item type="Lodging" expto="Marketing">
25      <Date>2003-01-02</Date>
26      <expense>299.45</expense>
27      <description>Treated Clients</description>
28    </expense-item>
29    <expense-item type="Entertainment" expto="Development">
30      <Date>2003-01-02</Date>
31      <expense>13.22</expense>
32      <Misc misctype="TeamBuilding"/>
33      <description>Bought signed XMLSpy Handbook</description>
34    </expense-item>
35  </expense-report>

```

To switch the text highlighting feature on, select *Enable auto-highlighting* in the Text View Settings dialog ([View | Text View Settings](#)⁹⁹⁵, screenshot below). A selection can be defined to be an entire word or a fixed number of characters. You can also specify whether casing should be taken into account or not.

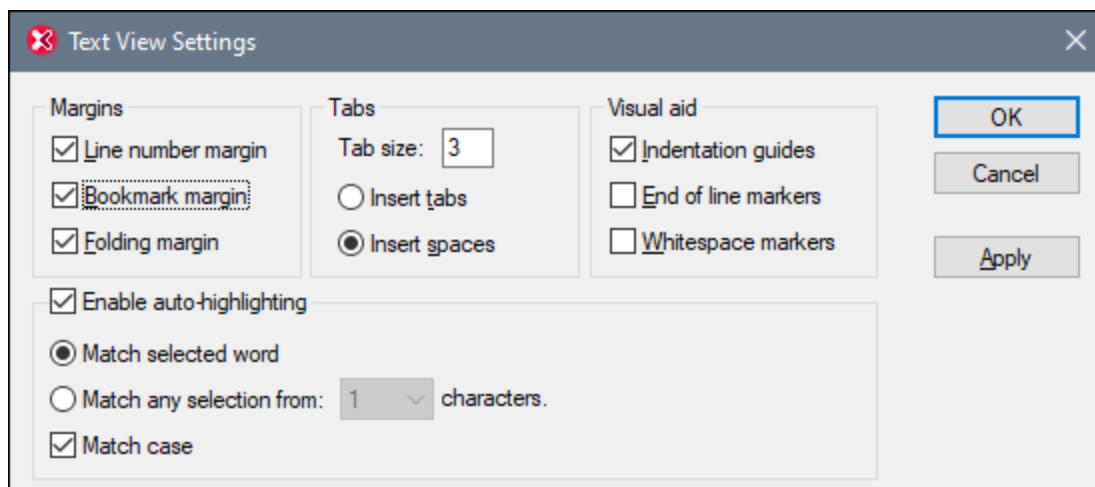

Note the following points:

- For a character selection, you can specify the minimum number of characters that must match, starting from the first character in the selection. For example, you can choose to match two or more characters. In this case, one-character selections will not be matched, but a selection consisting of

two or more characters will be matched. So, in this case, if you select `t`, then no matches will be shown; selecting `ty` will show all `ty` matches; selecting `typ` will show all `typ` matches; and so on.

- For word searches, the following are considered to be separate words: element names (without angular brackets), the angular brackets of element tags, attribute names, and attribute values without quotes.

Note: [Element start-tag and end-tag matching](#)¹³⁶ is a separate feature that is not affected by the *Enable auto-highlighting* setting.

Document overview in the scroll bar

The scroll bar provides the following features:

- It relates the sizes of the following to each other (see screenshot below): (i) the entire document (scroll bar); (ii) the document segment that is currently in the window (thumb); (iii) the current text selection (blue bar), if any; and (iv) the current cursor location (cursor-marker).
- It enables you to navigate the document by either: (i) dragging the scroll bar's thumb up and down, or (ii) clicking the **Page Up** and **Page Down** arrows (circled in green in the screenshot below).



Note the following points:

- The length of the scroll bar corresponds to the length of the entire document.
- If only a part of the document fits in the window, then this windowed part corresponds to the scroll bar's thumb (see screenshot above). You can drag the thumb up and down to bring other parts of the document into the window. It is as if the thumb represents the window and you are moving the window up and down the document in order to view the document.
- The current text selection is indicated in the scroll bar by the blue bar. The size of the blue bar relative to the size of the scroll bar is proportional to the size of the text selection relative to the size of the entire document. If the text selection does not exceed one line, the blue bar will not be visible.
- The cursor position is indicated by a dark blue cursor-marker. The cursor-marker's relative position in the scroll bar corresponds to the cursor's relative position in the document.

Go to line/character

This command in the **View** menu and Text toolbar enables you to go to a specific line and character in the document text.

4.2.5 Entry Helpers in Text View

What entry helpers are available in Text View depends upon the type of document being edited. A list of entry helpers is given below for the most common document types. The general use of entry helpers is [described below](#)¹⁴². Additional features for specific document types, if any, are described in the sections describing the respective document types.

- *XML*: Elements (*screenshot below*), Attributes, Entities

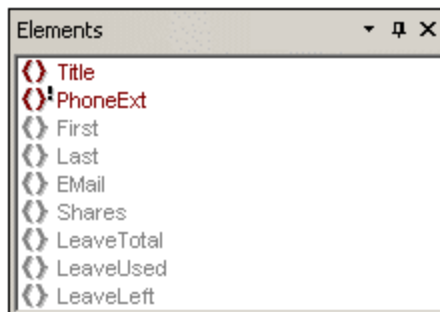

- *HTML*: Elements, Attributes, Entities
- *CSS*: CSS Outline, CSS Properties, HTML Elements
- *DTD*: None
- *XQuery*: XQuery Keywords, XQuery Variables, XQuery Functions
- *Text*: Entities

Note that several document types, such as XSD, XSLT, XHTML, and RDF, are essentially XML documents and will therefore have the Elements, Attributes, and Entities entry helpers.

Display and use of entry helper items

Different items in the various entry helpers are variously color-coded. These color codes are explained in the Entry Helpers documentation of the respective document types. In general, the following points should be noted about entry helpers:

- The entry helpers are context-sensitive and display items that may be inserted at that point.
- If the item has already been inserted at the selected (or at another equivalent and valid location) and may not be inserted again at that location (for example, an XML attribute), it is displayed in grey.
- If the item is mandatory, an exclamation mark icon is displayed next to it.
- To insert an entry helper item at the cursor selection point in the text, double-click the entry-helper item.
- When an element is inserted via the Elements entry helper, its start and end tags are inserted in the document text. Mandatory elements are also inserted if this option has been specified in the **Options** dialog (**Tools | Options | Editing**).

- When an attribute is inserted via the Attributes entry helper, the attribute is inserted at the cursor point together with an equals-to sign and quotes to delimit the attribute value. The cursor is placed between the quotes, so you can start typing in the attribute value directly.

Note: For large files, Auto-completion and entry helpers can be disabled, thus enabling faster loading and editing. The threshold file size is specified by the user. For more details, see the reference section, [Options | Editing](#) ¹⁰⁴⁷.

4.2.6 Split View

Split View divides the main window of Text View in two, vertically or horizontally, and displays the active document in both views. You can navigate separately in each view, which enables you to see different parts of the document side-by-side. Editing changes in either view are made to the underlying document and are immediately reflected in the other view.

Switching between Split View and Single View

Create split views of the **active document** as follows:

- *Horizontal split:* Drag down the horizontal-split icon at top right (see screenshot below).
- *Vertical split:* Drag the vertical-split icon at bottom right (see screenshot below) to the left.

To return to single view from split view, do one of the following:

- Double-click the splitter bar, or
- Move the splitter bar to one of the main window's edges that are parallel to it.

Note: A split view is created for each document individually.

Navigating and editing in split view

The main benefit of working in Split View is that you can view different parts of a long document side-by-side, while being able to edit the document in both views. The screenshot below shows a document in a vertical Split View.

```

1  <?xml version="1.0"?>
2  <!DOCTYPE book SYSTEM "book.dtd">
3  <book>
4  <title>Data on the Web</title>
5  <author>Serge Abiteboul</author>
6  <author>Peter Buneman</author>
7  <author>Dan Suciu</author>
8  <section id="intro" difficulty="easy" > [...] </section>
9  <title>Introduction</title>
10 <p>Text ... </p>
11 <section> [...] </section>
15 <section> [...] </section>
24 </section>
25 <section id="syntax" difficulty="medium" >
26 <title>A Syntax For Data</title>
27 <p>Text ... </p>
28 <figure height="200" width="500"> [...] </figure>
32 <p>Text ... </p>
33 <section> [...] </section>
37 <section> [...] </section>
45 <section> [...] </section>
49 </section>
50 </book>
51
52
53

```

Note the following points:

- When the view is split, the second view contains the same view as the original single view at the time of the split.
- All the [display features](#) ¹³³ (like line numbering and source folding), [editing features](#) ¹³⁶, [navigation features](#) ¹³⁹, etc. that are available in the single view of a document are available in both views of Split View (see [screenshot above](#)).
- In each view of Split View, you can scroll and navigate separately.
- You can use source folding separately in each view.
- All editing actions on the document, including entry helper actions, are reflected in both views.

4.2.7 Text View Shortcuts

The default shortcuts of commonly used Text View commands are listed below. You can change the default shortcuts in the [Keyboard tab of the Customize dialog](#) ¹⁰²⁷.

Text View commands

CTRL + E	Jump between Start/End Tags
CTRL + Shift + E	Select Element that Contains Cursor
CTRL + Alt + E	Go to Parent Element
CTRL + "+"	Zoom In
CTRL + "-"	Zoom Out

CTRL + 0	Reset Zoom
CTRL + mousewheel forwd	Zoom In
CTRL + mousewheel back	Zoom Out

4.3 Grid View

Grid View is available for XML documents, JSON documents, and DTDs. (*The screenshot below is of the Grid View of an XML document.*) Grid View shows the hierarchical structure of the document through a set of nested containers. These can be easily expanded and collapsed to get a clear picture of the document's structure. As a result, in Grid View, both contents and structure can be easily edited.

<?xml version="1.0" encoding="UTF-8"?>																					
Company	<>																				
xmlns	http://my-company.com/namespace																				
xmlns:xsi	http://www.w3.org/2001/XMLSchema-instance																				
xsi:schemaLocation	http://my-company.com/namespace AddressLast.xsd																				
Address	<>																				
xsi:type	US-Address																				
Name	US dependency																				
Street	Noble Ave.																				
City	Dallas																				
Zip	04812																				
State	Texas																				
Person (3)	<>																				
	<table border="1"> <thead> <tr> <th></th> <th>Manager</th> <th>Degree</th> <th>Programmer</th> <th>First</th> </tr> </thead> <tbody> <tr> <td>1</td> <td>false</td> <td>MA</td> <td>true</td> <td>Alfred</td> </tr> <tr> <td>2</td> <td>true</td> <td>Ph.D</td> <td>false</td> <td>Colin</td> </tr> <tr> <td>3</td> <td>true</td> <td>BA</td> <td>false</td> <td>Fred</td> </tr> </tbody> </table>		Manager	Degree	Programmer	First	1	false	MA	true	Alfred	2	true	Ph.D	false	Colin	3	true	BA	false	Fred
	Manager	Degree	Programmer	First																	
1	false	MA	true	Alfred																	
2	true	Ph.D	false	Colin																	
3	true	BA	false	Fred																	

For details about how to work in Grid View, see the subsections of this section.

Customizing Grid View

- To resize columns, place the cursor over the appropriate border and drag so as to achieve the desired width.
- To resize a column to the width of its largest entry, double-click on the grid line to the right of that column.
- To adjust column widths to display all content, select the menu item [View | Optimal widths](#) ⁹⁹⁴ command, or click on the Optimal Widths icon in the Grid View toolbar.
- The heights of cells are determined by their contents. They can be adjusted with the menu option **Tools | Options | View | Enhanced Grid View**, "Limit cell height to xx lines".

Note: If you mark data in Grid View and switch to Text View, that data will be marked also in Text View.

In this section

This section is organized according to the features of Grid View:

- [Document Display](#) ¹⁴⁷
- [Document Structure](#) ¹⁵⁵
- [Document Content](#) ¹⁵⁶
- [Split View](#) ¹⁶⁰

- [Entry Helpers](#) ¹⁶²
- [Table Display XML](#) ¹⁶³
- [Table Display \(JSON\)](#) ¹⁶⁷
- [Drag-and-Drop \(XML\)](#) ¹⁷²
- [Drag-and-Drop \(JSON\)](#) ¹⁷⁴
- [Formulas \(XML\)](#) ¹⁷⁷
- [Formulas \(JSON\)](#) ¹⁸⁰
- [Filters](#) ¹⁸⁴
- [Images](#) ¹⁸⁷
- [Context Menu](#) ¹⁸⁹
- [Grid View Settings](#) ¹⁹²

4.3.1 Document Display

In Grid View an XML, JSON, or DTD document is displayed hierarchically within a grid (see *screenshots below: XML document at left, JSON document at right*).

XML	<?xml version="1.0" encoding="UTF-8"?>	
<> OrgChart	<ul style="list-style-type: none"> ≡ xmlns http://www.xmlspy.com/schemas/orgchart ≡ xmlns:ipo http://www.altova.com/IPO ≡ xmlns:ts http://www.xmlspy.com/schemas/textstate ≡ xmlns:xsi http://www.w3.org/2001/XMLSchema-instance ≡ xsi:schemaLocation http://www.xmlspy.com/schemas/orgchart NanonullOrg.xsd 	
▲ <> CompanyLogo	<ul style="list-style-type: none"> ≡ href nanonull.gif 	
<> Name	Organization Chart	
▲ <> Office <1>	<ul style="list-style-type: none"> <> Name Nanonull, Inc. ▲ <> Desc <ul style="list-style-type: none"> ▼ <> para <1> <para>The company was established ▲ <> para <2> <ul style="list-style-type: none"> Abc Due to the fact that nanoelectronic publicity in the company's early ye <> Location US ▲ <> Address <ul style="list-style-type: none"> <> ipo:street 119 Oakstreet, Suite 4876 <> ipo:city Vereno <> ipo:state DC <> ipo:zip 29213 <> Phone +1 (321) 555 5155 0 <> Fax +1 (321) 555 5155 4 <> EEmail office@nanonull.com 	

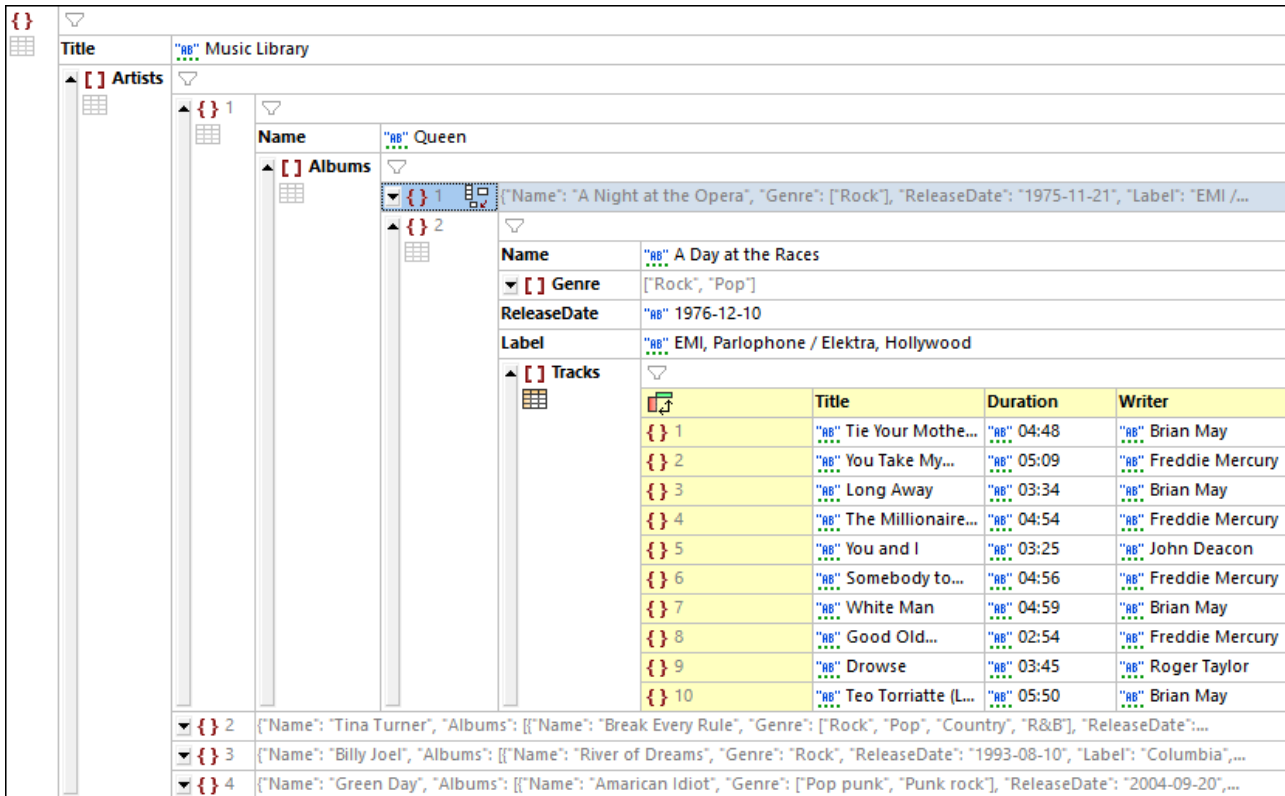

XML documents

Each XML grid line contains one XML structural item (known as a node), such as an element, attribute, comment, or text. The node types that are available in XML documents are listed in the screenshot below together with their icons.

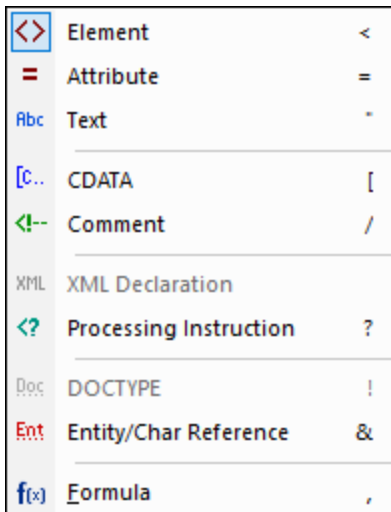

In an XML grid cell, the type of the XML node is indicated by the icon in the top left of the cell (see XML screenshot at topic start). You can change a node's type by clicking its icon and selecting another node type from the list of types that appears (screenshot above). Note that nodes of type Element, Attribute, and

Processing Instruction have a name and a value, whereas nodes of type *Text*, *CDATA*, and *Comment* have only a value. For example, an element node will have a name and a value, whereas a text node will have only a value.

Note: [Formulas](#)¹⁷⁷ are specific to XMLSpy.

JSON documents

Each *JSON grid line* contains one of the data structures shown in the table below (with their symbols). Note that both arrays and objects can contain child components that may be objects, arrays, or atomic values. In the JSON screenshot at the start of the topic, we see a root object that contains two `key:value` pairs: (i) `"Title": "Music Library"`, (ii) `"Artists": [Array]`. The array keyed to `Artists` contains four items that are objects.

{ }	An object (see definition ⁵⁰⁹). Objects contain <code>key:value</code> pairs.
[]	An array (see definition ⁵⁰⁹). Arrays contain items, which are typically objects or values.
	A <code>key:value</code> pair (see definition ⁵⁰⁹).

In a *JSON grid cell*, the type of the JSON node is indicated by the icon in the top left of the cell (see *the JSON screenshot at topic start*). You can change a node's type by clicking its icon and selecting another node type from the list of types that appears (see *screenshot below*).

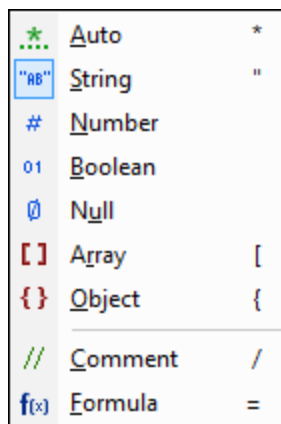

Note: Comments are supported in JSONC and JSON5. [Formulas](#)¹⁸⁰ are specific to XMLSpy.

DTD documents

For a description of the Grid View features of DTD documents, see the [DTD topic](#)³²³.

Features of document display in Grid View

Note the following features:

- You can zoom the grid in and out via **Ctrl + Mouse Wheel**, or **Ctrl+[Plus]** and **Ctrl+[Minus]**.
- XML elements at the same level and JSON objects, array, and array items at the same level are **numbered**, starting from 1. In the XML screenshot at the start of the topic, for example, the `office` element that is numbered one is the first of a sequence of `office` elements. The other elements in the

screenshot are not numbered—because they do not have sibling elements of the same name. In the JSON screenshot, for example, within the `Artists` array, the objects are numbered from 1 to 4. So also within the `Albums` and `Tracks` arrays. Note that this numbering is not contained in the actual document, but is a Grid View feature to help you see the structure of the document.

- XML nodes and JSON objects and arrays can be **expanded or collapsed** by clicking the arrowhead icon at the left of the node's symbol (see *screenshots at start of topic*). When an XML or JSON node is collapsed, any content it has is displayed as text in a single line. For examples, see the last three grid lines of the JSON screenshot at the top of the page.
- If you select multiple components at the same level, you can **expand/collapse all** of them by pressing **Shift** and clicking any one of the selected components' arrowheads.
- If **word-wrap** is switched on via the Grid View toolbar (see *below*), then all cells containing text that is longer than the width of the cell will wrap. You can toggle off word-wrap by clicking its icon in the Grid View toolbar.
- Notice that node/content items in XML Grid View and `key:value` pairs in JSON Grid View are represented on one line in Grid View's standard mode. However, when they are part of [Table Display](#)¹⁶³, the node name (XML) or key name (JSON) become the column headers of tables. For a brief description of **Table View**, see the relevant sections below.

Scroll headers

As you scroll down an XML, JSON, or DTD document in Grid View and nodes at the top of the window go out of the view window, a header bar appears at the top of Grid View (see *screenshot below*). This header bar—or scroll header—displays all the ancestor elements of the node currently at the top of the view window. For example, in the screenshot below, the node at the top of the view window is the attribute `/Company/Person[1]/@Programmer` node. Its parent is the first `Person` element, and the parent of this `Person` element is the root element, which is named `Company`. So the ancestors of the topmost node in the view window (`@Programmer`) are the root element `Company` and the first `Person` element, and these are displayed in the header bar: `/Company/Person[1]/`.

<> Company		<> Person<1>	
=	Programmer	true	
<>	First	Alfred	
<>	Last	Aldrich	
<>	PhoneExt	33	
<>	Email	Aldrich@work	
▲	<> Person<2>		
=	Manager	true	
=	Degree	Ph.D	
=	Programmer	false	
<>	First	Colin	
<>	Last	Coletti	

If you click any node in the header bar, then that node will be selected and displayed in the view window. The header bar, in this way, enables you to quickly navigate the document in Grid View.

Toolbar commands

Commands related to Grid View editing can be accessed quickly via the respective Grid View toolbar for XML or JSON (*screenshots below*), located in the toolbars area at the top of the application window. The toolbar that is displayed will depend on the currently active document. Hover over a toolbar icon to see its name and shortcut.

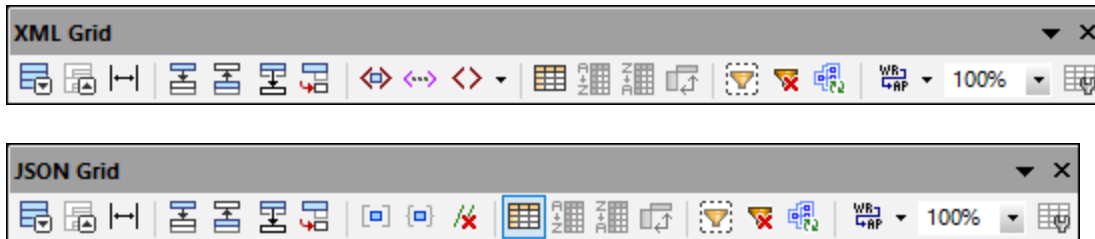

Note: The commands accessible via these toolbars are also available in the [XML menu](#)⁶⁵³ and [JSON menu](#)⁶⁶⁴, respectively.

Display-related commands

The commands in the table below are useful for modifying the display in Grid View.

	Optimizes widths of grid columns according to cell content.
	When colored, Table Display ¹⁶³ is on, otherwise off. Click to switch the display
	When colored, a filter ¹⁸⁴ for the table, object, or array is active; otherwise the filter is deactivated. Click to deactivate/activate. To edit the expression, double-click it
	Toggle command to word-wrap cells. When selected, word-wrap is on. By default, only the contents of items are wrapped. If you want to additionally wrap the names of items, choose this option from the icon's dropdown list.
	Zoom level of Grid View

Filtered display

A filter can be placed on element nodes (XML) or array or object nodes (JSON). This enables you to filter the node to show only the descendants defined in the filter. For a detailed description of filters, see the topic [Filters](#)¹⁸⁴.

Table display (XML)

Repeating elements are shown in *standard* Grid View, one after the other, progressing vertically downward in document order (*screenshot below left*). However, displaying repeating elements as the *rows of a table* provides additional editing features. In the screenshots below, the `PERSON` element is the repeating element. The screenshot at left shows standard Grid View; the first `PERSON` element is shown expanded, while subsequent instances are shown collapsed. The screenshot at right shows the repeating `PERSON` elements as the rows of a table.

To switch to Table View, click the **Table Mode** icon (*circled in green in the screenshot below left*). When switched to table display, the icon is displayed in color (*see screenshot below right*).

Person <1>	
<> First	Fred
<> Last	Landis
<> Title	Program Manager
<> PhoneExt	951
<> EMail	f.landis@nanonull.com
<> Shares	2000
<> LeaveTotal	28
<> LeaveUsed	10
<> LeaveLeft	18

Person <2>	
<Person> <First> Michelle</First> <Last> Butler</Last> <Title> Software Engineer</Title>	
<Person> <First> Ted</First> <Last> Little</Last> <Title> Software Engineer</Title> <Pho	

Person (6)			
	<> First	<> Last	<> Title
1	Fred	Landis	Program Manager
2	Michelle	Butler	Software Engineer
3	Ted	Little	Software Engineer
4	Ann	Way	Technical Writer
5	Liz	Gardner	Software Engineer
6	Paul	Smith	Software Engineer

Table View offers unique editing benefits in that whole rows and columns can be manipulated relative to other columns and rows in the table. This enables such operations as sorting table rows on the values of one column. For example, in the screenshot above right, the six `Person` elements can be sorted on the basis of their `Last` child elements via a single command in the [Grid View toolbar](#)¹⁴⁷. This is simpler than running an XSLT transformation, which would be the usual way to sort an XML nodeset.

For more information, see the topic [Table Display \(XML\)](#)¹⁶³.

Table display (JSON)

Objects and arrays that contain at least one object or array can be viewed either as a list (*highlighted in screenshot at left*) or as a table (*highlighted in screenshot at right*). The display can be switched between list display and table display for individual objects and arrays.

Name	"AB" Billy Joel
▲ [] Albums	▼
▲ [] 1	▼
Name	"AB" River of Dreams
Genre	"AB" Rock
ReleaseDate	"AB" 1993-08-10
Label	"AB" Columbia
▲ [] Tracks	▼
▲ [] 1	▼
Title	"AB" No Man's Land
Duration	"AB" 04:48
▲ [] 2	▼
Title	"AB" The Great Wall of China
Duration	"AB" 05:45
▲ [] 3	▼
Title	"AB" Blonde Over Blue
Duration	"AB" 04:55

Name	"AB" Billy Joel																																	
▲ [] Albums	▼																																	
▲ [] 1	▼																																	
Name	"AB" River of Dreams																																	
Genre	"AB" Rock																																	
ReleaseDate	"AB" 1993-08-10																																	
Label	"AB" Columbia																																	
▲ [] Tracks	▼																																	
	<table border="1"> <thead> <tr> <th></th> <th>Title</th> <th>Duration</th> </tr> </thead> <tbody> <tr> <td>{ } 1</td> <td>"AB" No Man's Land</td> <td>"AB" 04:48</td> </tr> <tr> <td>{ } 2</td> <td>"AB" The Great Wall of China</td> <td>"AB" 05:45</td> </tr> <tr> <td>{ } 3</td> <td>"AB" Blonde Over Blue</td> <td>"AB" 04:55</td> </tr> <tr> <td>{ } 4</td> <td>"AB" A Minor Variation</td> <td>"AB" 05:36</td> </tr> <tr> <td>{ } 5</td> <td>"AB" Shades of Grey</td> <td>"AB" 04:10</td> </tr> <tr> <td>{ } 6</td> <td>"AB" All About Soul</td> <td>"AB" 05:59</td> </tr> <tr> <td>{ } 7</td> <td>"AB" Lullabye (Goodnight, My Angel)</td> <td>"AB" 03:32</td> </tr> <tr> <td>{ } 8</td> <td>"AB" The River of Dreams</td> <td>"AB" 04:05</td> </tr> <tr> <td>{ } 9</td> <td>"AB" Two Thousand Years</td> <td>"AB" 05:19</td> </tr> <tr> <td>{ } 10</td> <td>"AB" Famous Last Words</td> <td>"AB" 05:01</td> </tr> </tbody> </table>		Title	Duration	{ } 1	"AB" No Man's Land	"AB" 04:48	{ } 2	"AB" The Great Wall of China	"AB" 05:45	{ } 3	"AB" Blonde Over Blue	"AB" 04:55	{ } 4	"AB" A Minor Variation	"AB" 05:36	{ } 5	"AB" Shades of Grey	"AB" 04:10	{ } 6	"AB" All About Soul	"AB" 05:59	{ } 7	"AB" Lullabye (Goodnight, My Angel)	"AB" 03:32	{ } 8	"AB" The River of Dreams	"AB" 04:05	{ } 9	"AB" Two Thousand Years	"AB" 05:19	{ } 10	"AB" Famous Last Words	"AB" 05:01
	Title	Duration																																
{ } 1	"AB" No Man's Land	"AB" 04:48																																
{ } 2	"AB" The Great Wall of China	"AB" 05:45																																
{ } 3	"AB" Blonde Over Blue	"AB" 04:55																																
{ } 4	"AB" A Minor Variation	"AB" 05:36																																
{ } 5	"AB" Shades of Grey	"AB" 04:10																																
{ } 6	"AB" All About Soul	"AB" 05:59																																
{ } 7	"AB" Lullabye (Goodnight, My Angel)	"AB" 03:32																																
{ } 8	"AB" The River of Dreams	"AB" 04:05																																
{ } 9	"AB" Two Thousand Years	"AB" 05:19																																
{ } 10	"AB" Famous Last Words	"AB" 05:01																																

For a description of JSON Grid View's Table Display, see the section [Table Display \(JSON\)](#) ¹⁶⁷.

4.3.2 Document Structure

In Grid View, the XML, JSON, or DTD document structure can be edited graphically. For example, you can insert, append and delete nodes, drag-and-drop nodes to different locations, and convert one type of node to another type.

Adding new nodes

There are two ways to add new nodes to the document:

- The Siblings and Children entry helpers enter specific nodes at the selected location.
- You can add a new node that is not defined in a schema as a sibling, child, or parent.

Siblings and Children entry helpers

How the Siblings and Children entry helpers is explained here with reference to an XML document that is associated with a schema (DTD or XML Schema). A JSON document that is associated with a JSON Schema would work in a similar way.

When a node is selected in the Main Window, the sibling and children that are allowed at that point (according to the schema) are displayed in the Siblings and Children entry helpers, respectively.

- In each of these entry helpers, use the toolbar icons to toggle the visibility of elements and attributes on or off. Mandatory nodes are displayed with an exclamation mark.
- Nodes in gray cannot be added. This is because of one of the following reasons: (i) The node has already been added, and no more instances of it are allowed by the schema, as in the case of the `Address` sibling in the screenshot below; (ii) Another node needs to be added before the grayed out node can be added, as in the case of the `Last` child in the screenshot below, which can be added only after the `First` child has been added.

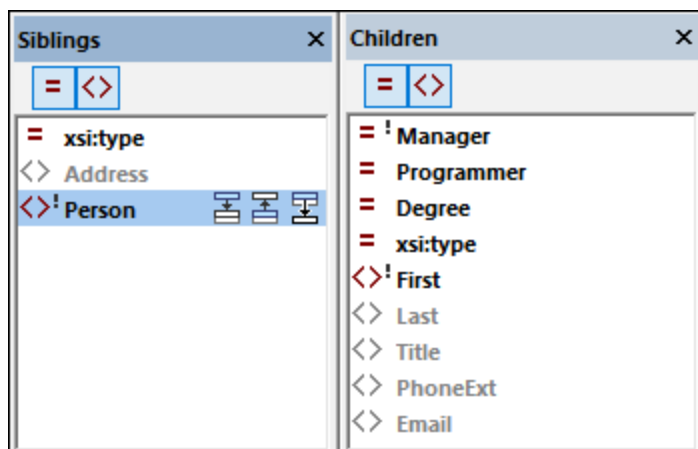

Add nodes as follows:

- **Siblings:** In the entry helper, select the node you want to add as a sibling. Then click the appropriate icon (see screenshot above left), depending on whether you want to add the sibling after or before the node selected in the grid, or append it as the last of the selected node's siblings.
- **Children:** Double click the node you want to add as a child.

Inserting new nodes

When a node in the document (that is, a grid cell) is selected, you can add a new empty node as a sibling, child, or parent. The commands for these operations are listed in the table below, and are available in: (i) the context menu of the cell; (ii) the [XML menu](#)⁸⁵³ or [JSON menu](#)⁸⁶⁴; and (iii) the [Grid View toolbar](#)¹⁴⁷.

Command	Shortcut
Insert (Sibling) After	Ctrl+Enter
Insert (Sibling) Before	Ctrl+Shift+Enter
Append (Sibling)	Ctrl+Alt+A
Add Child	Ctrl+Alt+Enter
Add Attribute (XML)	Ctrl+Alt+I
Wrap in Element (XML)	Ctrl+Alt+W
Wrap in Array (JSON)	Ctrl+Alt+W
Wrap in Object (JSON)	Ctrl+Shift+W

Note the following points:

- The new node is created as an empty element (XML) or empty property (JSON) by default. You can [change the node type](#)¹⁵⁶ subsequently.
- The **Wrap in Element** command creates an element node around the current node. This element becomes the new parent of the current node. The **Wrap in Array** and **Wrap in Object** commands in JSON documents work similarly.

Modifying structure with standard Windows mechanisms

In Grid View, you can also modify document structure using the following Windows mechanisms:

- *Delete*: Select a component and delete it with the **Delete** key.
- *Move*: Select a component and drag-and-drop it to a new location.

4.3.3 Document Content

Editing content in Grid View is straightforward: Double-click inside the content field and edit the content as required. The node type can be quickly changed by clicking the node's *Type* icon and selecting another type from the menu that appears. In XML documents, entities can be inserted via the Entities entry helper. Grid View additionally offers validation and find-and-replace functionality.

This topic describes the unique Grid View features of XML and JSON documents. For a description of the Grid View features of DTD documents, see the [DTD topic](#)³²³.

Type selection (XML)

The cells in Grid View contain nodes of the XML document. We have grouped the types as follows:

- *Name–Value types*: Element, attribute, processing instruction (PI). Nodes of this type have names and values.
- *Value types*: Text, CDATA, comment, entity/character references. Nodes of this type take values only.
- *Definition types*: XML declaration, DOCTYPE (internal or external DTD). These nodes define properties of the XML document.
- *Special container types specific to XMLSpy*: Formula.

The type of a value is indicated by a symbol in front of the value (see screenshot below). To change a type, click its symbol and select the type you want from the menu that appears. Alternatively, right-click in a cell and, from the context menu that appears, select a type from the **Type** sub-menu. The symbols and shortcuts of types are shown in the screenshot below:

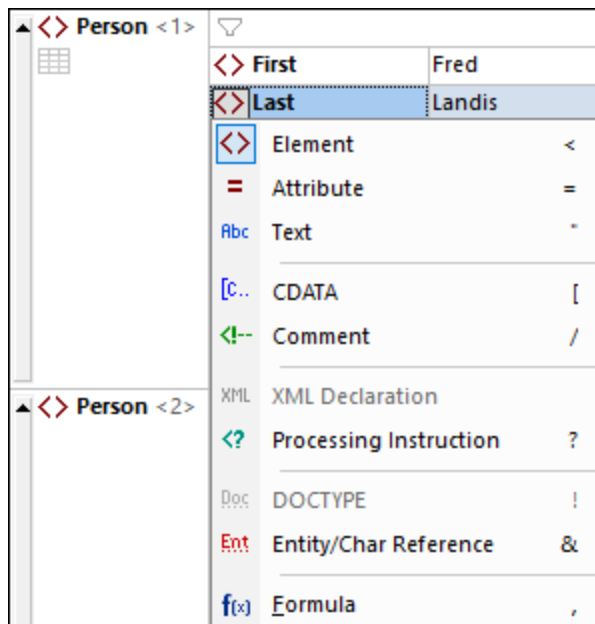

Note the following points:

- Nodes of type *Element*, *Attribute*, and *PI* take a name and a value, whereas nodes of type *Text*, *CDATA*, and *Comment* take only a value. For example, an element node will have a name and content, whereas a text node will have only a value.
- Type conversions try to preserve the original key and value. For example, if you convert an element to an attribute, the attribute will have (i) the same name as the element, and (ii) a value that is, as far as possible, the same as the content of the element.
- In the sequence of an element's child nodes, attributes are always listed first. As a result, type conversions could lead to a reordering of nodes.
- In the case of mixed content (character data interspersed with element children, such as a paragraph element that contains text as well as bold and italic elements), consecutive text nodes are not allowed and so might automatically be joined.
- You can set an option to determine whether, when multiple nodes are selected for conversion to a single type, this change should go ahead or not, or whether you should be warned.

- You can edit raw text in a cell or a row by selecting the parent cell or parent row to be edited in this way and then clicking the **Edit as Raw Text** icon in the toolbar. When you edit text as raw text, entities and markup in that cell or row will not be resolved, respectively, into glyphs and Grid View components (and can therefore be edited).

Type selection (JSON)

JSON Grid View distinguishes the following type categories:

- Simple types*: String, Number, Boolean, Null
- Special simple types*: Auto (which is detected from the value), Comment (JSONC, JSON5)
- Container types*: Object, Array
- Special container types*: Formula

The type of a value is indicated by a symbol in front of the value (see screenshot below). To change a type, click its symbol and select the type you want from the menu that appears. The symbols and shortcuts of types are shown in the screenshot below:

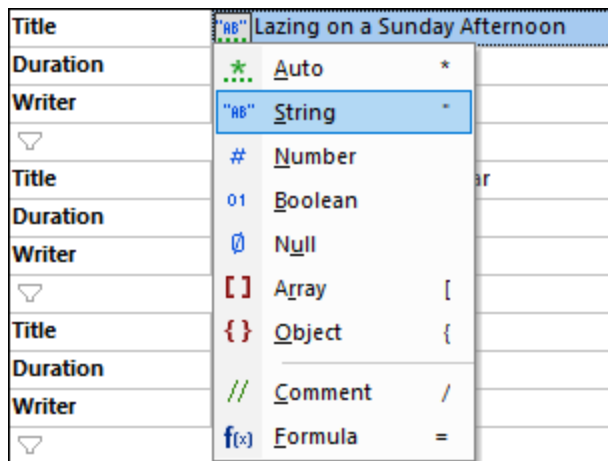

Auto-detected types have green dots under them (see screenshot below). An explicit type is a type that you assign.

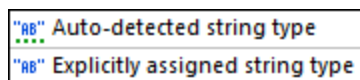

Type-related actions occur in two situations:

- When a JSON document is loaded: All simple types are converted to `Auto`, which are automatically detected from the values. For example `"MyString"` is automatically detected as a String type, `123` as a Number type, `true` as a Boolean type, and `null` as a Null type. In cases of ambiguous strings, select the type explicitly.
- When a new data structure or value is entered: Simple types are auto-detected and the type is automatically assigned. You can change the type subsequently if you want to.

Note: The [JSON Grid View settings](#)¹⁹² enable you to specify (i) how type changes are to be handled when multiple cells are selected, and (ii) how values of atomic types should be treated when the type is changed to an array or object.

Auto-completion

Auto-completion is enabled when the document being edited is associated with a schema.

Auto-completion provides you with entry options at the cursor location (see *screenshot below*). These options, which are based on the definitions in the schema, are provided (i) via pop-ups in the main window, and (ii) via the entry helpers. The pop-ups and entry helpers each display a list of entries that are valid at that cursor location. To move through the entries in the pop-up list, use the arrow keys. Select an entry from the pop-up window or double-click an entry in the entry helper to insert it.

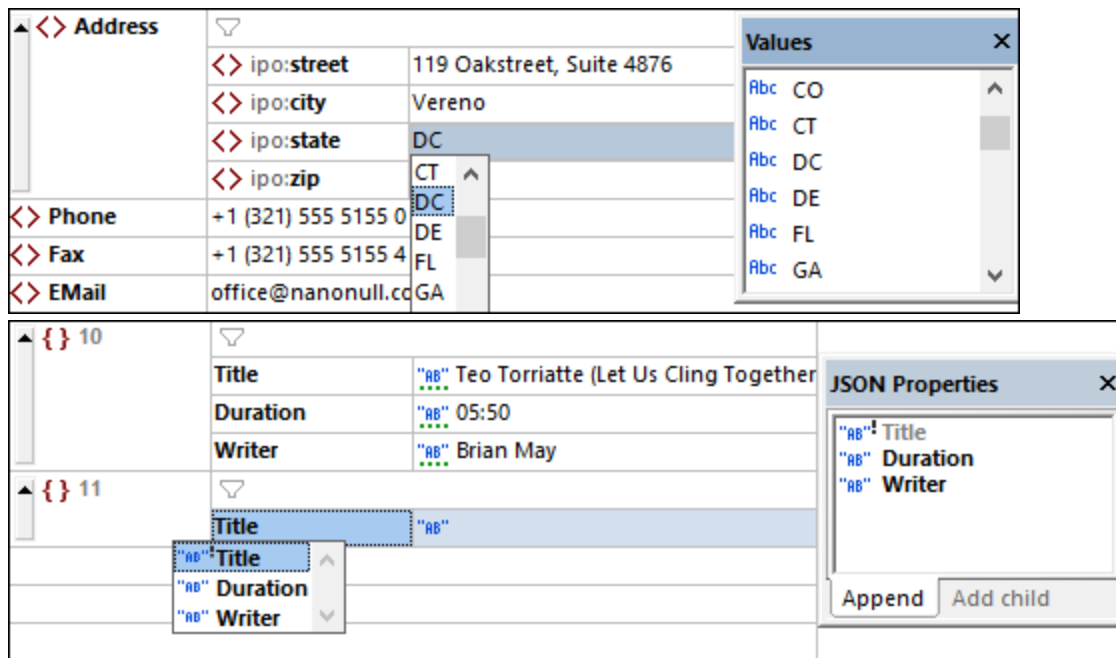

For JSON documents, note the following points:

- If the document is a JSON schema, then auto-completion is based on the schema version indicated by the `$schema` ⁵¹² keyword. For more information, see also [JSON Schema Version](#) ⁵²⁴.
- If the document is a JSON/JSON5 instance, then a [JSON schema must be assigned to the instance](#) ⁵⁶¹ in order for auto-completion to be enabled.

Validate on modification

The *Validate on Edit* mode is toggled off by default. When toggled on, well-formed checks and validation checks are carried out as you edit a document in Grid View. For validation to be carried out (additional to well-formed checks), a schema must be assigned to the document. Errors are shown by (i) displaying erroneous text in red and (ii) flagging the location with a red exclamation mark. If a smart fix is available for an error, then a light bulb icon is shown on the line that generates the error. When you place the mouse over the icon, a popup appears that lists available smart fixes. Select a fix to apply it immediately. For more information, see [Validating XML Documents](#) ²⁹⁴ and [Validating JSON Documents](#) ⁵⁶¹.

The *Validate on Edit* mode can be toggled on/off either (i) via the [XML | Validate on Edit](#) ⁸⁶³ menu command, (ii) the **Validate on Edit** toolbar button, or (iii) via the *On Edit* option of the [Validation settings of the Options dialog](#) ¹⁰⁴¹.

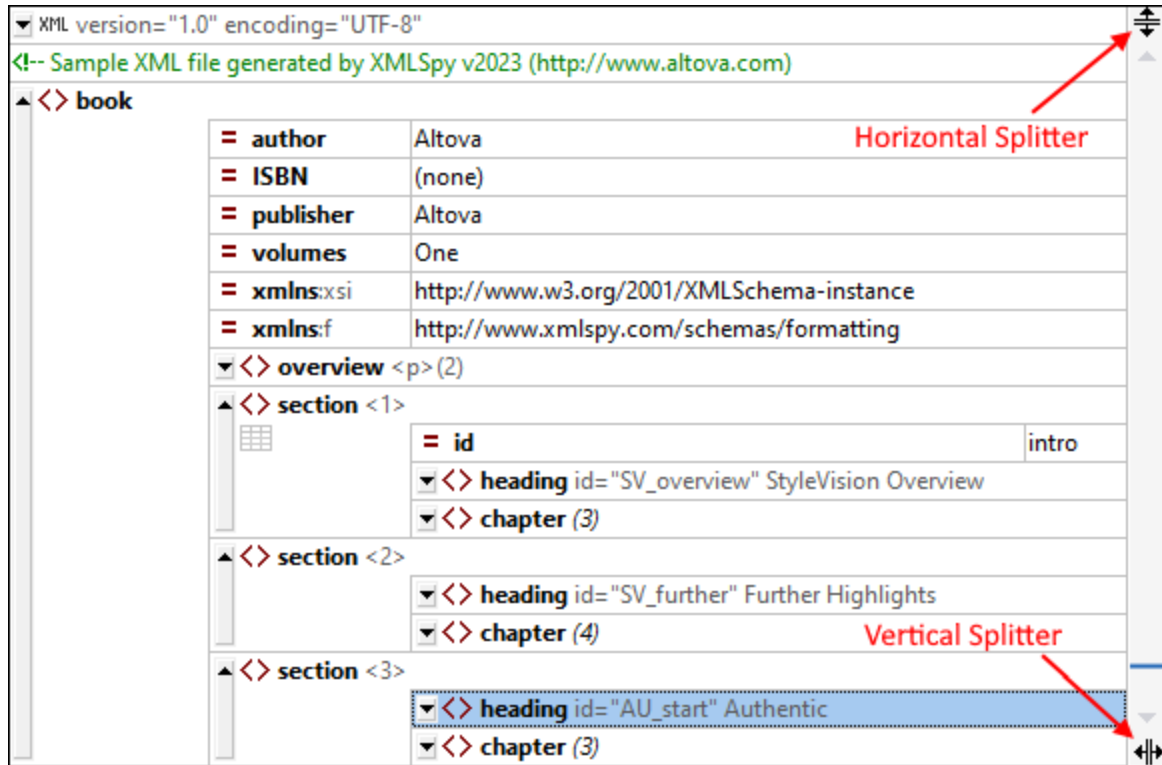

To return to single view from split view, do one of the following:

- Double-click the splitter bar, or
- Move the splitter bar to one of the parallel window sides and release the mouse button.

Note: A split view is created for each document individually.

Navigating and editing in split view

The main benefit of working in Split View is that you can view different parts of a long document side-by-side or view the same part in the alternative [Table Display](#) ¹⁶³ simultaneously. In Split View, you can edit the document in both views. The changes will be applied to the underlying document and will be reflected in both views. The screenshot below shows a document in a vertical Split View.

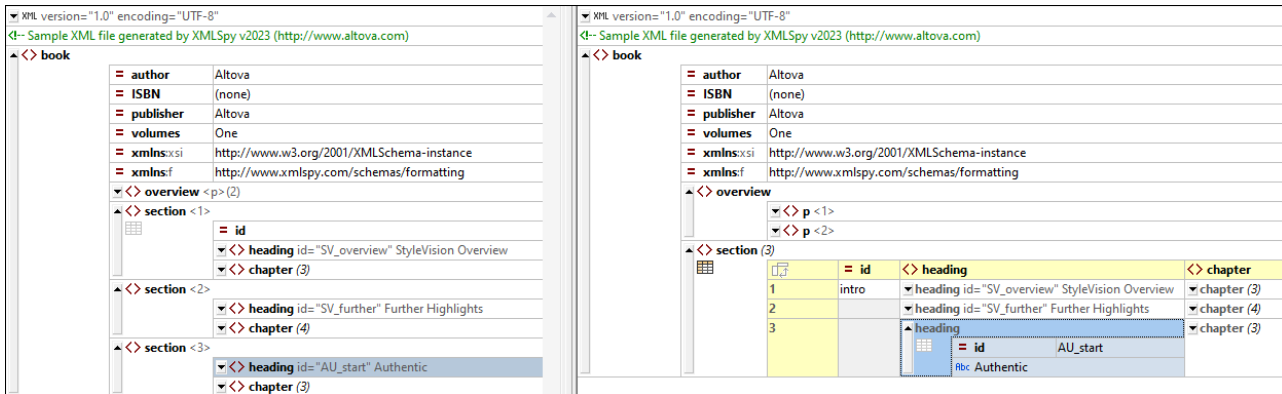

Note the following points:

- When the view is split, the second view contains the same view as the original single view at the time of the split.
- All the [display features](#) ¹⁴⁷, [editing features](#) ¹⁵⁶, navigation features, etc. that are available in the single view of a document are available in both views of Split View (see screenshot above).
- In each view of Split View, you can scroll and navigate separately.
- You can use [table display](#) ¹⁶³ separately in each view.
- All editing actions on the document, including entry helper actions, are reflected in both views.

4.3.5 Entry Helpers

For XML, JSON, and DTD documents in Grid View, there are three entry helpers: Siblings, Children, and Values. When a cell is selected in Grid View, context-sensitive items appear in each entry helper. What appears depends on the document structure and node constraints defined in the schema that has been assigned to the XML document.

Siblings and Children entry helpers

The Siblings and Children entry helpers will contain, respectively, available sibling and children nodes of the node selected in Grid View. See the screenshot of the Sibling entry helper below. Nodes that have already been added are shown in gray, while those that have not yet been added are shown in black. Mandatory elements are indicated with an exclamation mark. In the screenshot below of an active XML document, all sibling nodes, except the mandatory `state` element, have already been added to the document.

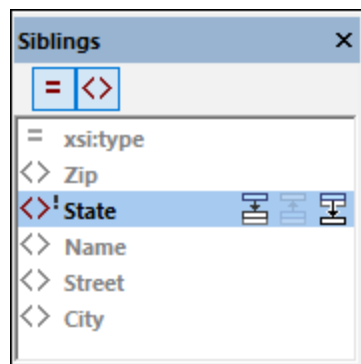

When you select an item in the Siblings or Children entry helpers, icons appear on the right hand side (see *screenshot above*) that enable you, respectively, to insert the item immediately after the node selected in Grid View, immediately before it, or (appended) after all its siblings.

Values entry helper

When a node is selected in Grid View that can take a value and if that node has a set of possible values defined for it in the schema, these values are listed in the Values entry helper. Double-click any of these values to enter it.

4.3.6 Table Display (XML)

About Table Display

In standard Grid View, if an element repeats, then each element instance is displayed, one after the other in document order. In the screenshot below, for example, the `PERSON` element is the repeating element.

Person <1>	
First	Fred
Last	Landis
Title	Program Manager
PhoneExt	951
EEmail	f.landis@nanonull.com
Shares	2000
LeaveTotal	28
LeaveUsed	10
LeaveLeft	18

Person <2>	
First	Michelle
Last	Butler
Title	Software Engineer
PhoneExt	654
EEmail	m.butler@nanonull.com
Shares	1500
LeaveTotal	19
LeaveUsed	9
LeaveLeft	10

A repeating element, such as the `Person` element shown above, can also be displayed as a table (*screenshot below*). In table representation, child nodes of the repeating element form the table's columns, while instances of the repeating element form the table's rows. To switch to Table View, click the **Table Mode** icon that is shown on the first instance of the repeating element (*circled in green in the screenshot above*). When switched to table display, the **Table Mode** icon is displayed in color (*see screenshot below*).

Person (6)				
	First	Last	Title	
1	Fred	Landis	Program Manager	
2	Michelle	Butler	Software Engineer	
3	Ted	Little	Software Engineer	
4	Ann	Way	Technical Writer	
5	Liz	Gardner	Software Engineer	
6	Paul	Smith	Software Engineer	

Table View offers a unique editing advantage in that whole rows and columns can be manipulated relative to other columns and rows in the table. This enables such operations as sorting rows on the values of one column. For example, in the screenshot above, the six `Person` elements can be sorted on the basis of their `Last` child elements via a simple GUI operation. Such an operation (*see below for details*) is simpler than running an XSLT transformation, which is the usual way to sort an XML nodeset.

Note

- Table Display can be applied only to a sequence of elements of the same name.
- Table Display is also available for a single element. The element's **Table Mode** icon becomes visible when the element is clicked.
- Table Display colors can be set in the Options dialog: [Fonts and Colors | Grid View | Cell Colors](#) ¹⁰⁶³.

Icons for viewing and editing in Table Display

The icons shown below are available in Table Display and provide viewing and editing functionality. They are available in table cells and/or the Grid View toolbar.

	Optimizes widths of grid columns according to cell content.
	When colored, Table Display ¹⁶³ is on, otherwise off. Click to switch the display
	A toggle command in top left cell of table. Switches rows to columns and vice versa
	When colored, a filter ¹⁸⁴ for the table, object, or array is active; otherwise the filter is deactivated. Click to deactivate/activate. To edit the expression, double-click it
	Toggle command to word-wrap cells. When selected, word-wrap is on. By default, only the contents of items are wrapped. If you want to additionally wrap the names of items, choose this option from the icon's dropdown list.
	Zoom level of Grid View
	Enabled when a column header in Table View is selected. The buttons sort the rows of the table, respectively, in descending or ascending order of column content

Editing in Table Display

In Table Display, you can carry out the editing actions described below.

Add a table row (new instance of the table's repeating element)

You can add a new row—that is, another instance of the table's repeating element—as follows:

1. Right-click *the cell containing the row number* of the row above or below which you want to add a new row.
2. Select the command **Insert After (Ctrl+Enter)** to add a row below the selected row, or **Insert Before (Ctrl+Shift+Enter)** to add a row above the selected row. These commands are also available in the [XML menu](#) ⁸⁵³ and the [Grid View toolbar](#) ¹⁴⁷.

The new row will be created as an element node. You can change its node type if you want (*see below for details*).

Add sibling or child elements to a table cell

If a table cell represents a child element of a table row, then you can give this child element a following-sibling node or a child node. Right-click the table cell and select the command **Append (Ctrl+Alt+A)** or **Add Child (Ctrl+Alt+Enter)**, respectively. These commands are also available in the [XML menu](#) ⁸⁵³ and the [Grid View toolbar](#) ¹⁴⁷. The new row will be created as an element node. You can change its node type if you want (*see below for details*).

Wrap cell in element

You can create an element around a table cell. The new element will be created at a level between that of the cell and that of the cell's parent. To do this, right-click the table cell and select the command **Wrap in Element (Ctrl+Alt+W)**. This command is also available in the [XML menu](#) ⁸⁵³ and the [Grid View toolbar](#) ¹⁴⁷.

Add a table column (new child node of all instances of table's repeating element)

You can add a new column—that is, a new child node of all instances of the table's repeating element—as follows:

1. Right-click a column header or a non-empty cell of a column.
2. Select the command **Insert After (Ctrl+Enter)** to add a column to the right of the selected column, or **Insert Before (Ctrl+Shift+Enter)** to add a column to the left of the selected column. These commands are also available in the [XML menu](#)⁸⁵³ and the [Grid View toolbar](#)¹⁴⁷.

The new column will be created as an element node. You can change its node type if you want (see below for details).

Change node types and names of columns

To change the node type of a column, click the node type icon of the column and, from the menu that appears, select the new node type. The type of this node will be changed for all instances of the repeating element.

To change the name of a column header, double-click the name and edit it. As a result, the name of this node will be changed in all instances of the repeating element.

Sort table rows on the values of a selected column

You can sort the rows of a table on the relative values of one of its child nodes (a column). For example, you can sort rows on the basis of the *LastName* column to give you the repeating elements of the table sorted alphabetically. To sort on a column, select the column header and then click the [Grid View toolbar](#)¹⁴⁷ command **Ascending Sort** or **Descending Sort**. These commands are also available in the [XML menu](#)⁸⁵³.

Sort order in some languages, especially those with non-Latin alphabets, may benefit from enabling the beta Unicode UTF-8 support in the Language Region Settings dialog of Windows 10 (or later). Do this as follows: Go to your Windows *Settings* dialog and search for *Language Settings*. Under *Related Settings*, click *Administrative language settings*. In the Region dialog that appears, go to the *Administrative* tab, and, under *Language for non-Unicode programs*, click *Change system locale*. In the Region Settings dialog that appears (screenshot below), select the option *Beta: Use Unicode UTF-8 for worldwide language support* and click **OK**.

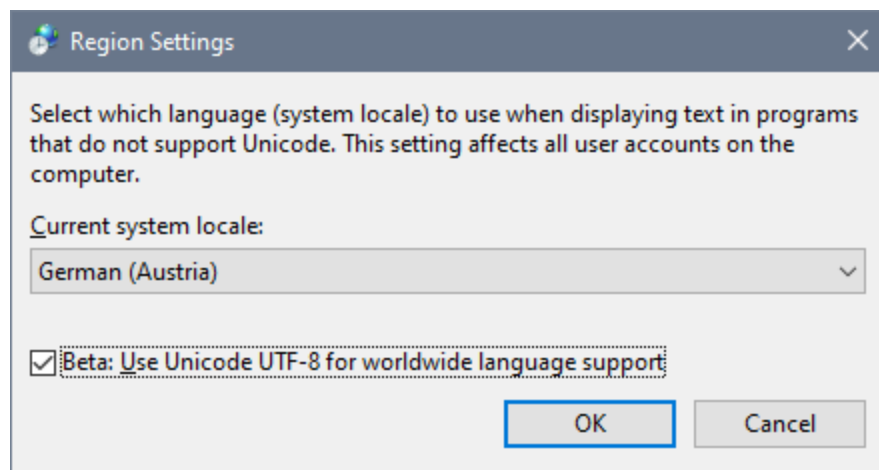

Table Display and external applications

You can take advantage of the table structure to exchange data between Table Display and a spreadsheet application (such as MS Excel). To move data from Table Display, do the following:

1. In Table Display, select the nodes you want to copy. Do this by clicking the cells themselves, column headers, row headers, or the entire table. If you click the entire table or column headers, then column headers are also copied; otherwise they are not. (In the screenshot below, rows 2 and 3 are selected.)

	= type	= expto	<> Date	<> expense	<> description
1	Lodging	Sales	2003-01-01	122.11	
2	Lodging	Development	2003-01-02	122.12	Played penny arcade
3	Lodging	Marketing	2003-01-02	299.45	Treated Clients

2. Select the context menu command [Copy | Copy as Tab-separated Text](#)⁸⁰⁶.
3. Paste the data directly into the spreadsheet program.

	A	B	C	D	E
1	Lodging	Development	1/2/2003	122.12	Played penny arcade
2	Lodging	Marketing	1/2/2003	299.45	Treated Clients

Data exchange works in both directions. You can also copy data from a spreadsheet to Table Display. Do this as follows:

1. Select a range in the external application and copy it to the clipboard (with **Ctrl+C**).
2. Select a single cell in Table Display.
3. Paste the copied data with **Ctrl+V**.

The data will be pasted into the table with a structure corresponding to the original structure and starting from the cell selected in Table View. The following points need to be noted:

- If data already exists in these cells in Table View, the new data overwrites the original data.
- If more rows and/or columns are required to accommodate the new data, these are created.
- The data becomes content of the elements represented by the respective cells.

For more complex data exchange tasks, use the unique [import/export](#)⁹⁶¹ functions of XMLSpy.

4.3.7 Table Display (JSON)

Table Display view

Objects and arrays that contain at least one object or array can be viewed either as a list (*highlighted in screenshot at left*) or as a table (*highlighted in screenshot at right*). To switch between these two views, click the table icon that is located below the object or array icon (*see screenshot*). In array tables, the array items are displayed as rows. For example, in the screenshot below right, the `Tracks` array is displayed as a table. This array consists of child objects, which are displayed as rows. Each object's properties (`Title` and `Duration` in the screenshots below) are shown as columns, with the names of common properties being displayed as the headers of columns. To switch rows and columns, click the icon in the top left cell of the table.







Name		"AB" Billy Joel	
▲ [] Albums		▼	
▲ [] 1		▼	
Name		"AB" River of Dreams	
Genre		"AB" Rock	
ReleaseDate		"AB" 1993-08-10	
Label		"AB" Columbia	
▲ [] Tracks		▼	
▲ [] 1		▼	
Title		"AB" No Man's Land	
Duration		"AB" 04:48	
▲ [] 2		▼	
Title		"AB" The Great Wall of China	
Duration		"AB" 05:45	
▲ [] 3		▼	
Title		"AB" Blonde Over Blue	
Duration		"AB" 04:55	

Name		"AB" Billy Joel	
▲ [] Albums		▼	
▲ [] 1		▼	
Name		"AB" River of Dreams	
Genre		"AB" Rock	
ReleaseDate		"AB" 1993-08-10	
Label		"AB" Columbia	
▲ [] Tracks		▼	
▲ [] 1		▼	
Title		"AB" No Man's Land	
Duration		"AB" 04:48	
▲ [] 2		▼	
Title		"AB" The Great Wall of China	
Duration		"AB" 05:45	
▲ [] 3		▼	
Title		"AB" Blonde Over Blue	
Duration		"AB" 04:55	
▲ [] 4		▼	
Title		"AB" A Minor Variation	
Duration		"AB" 05:36	
▲ [] 5		▼	
Title		"AB" Shades of Grey	
Duration		"AB" 04:10	
▲ [] 6		▼	
Title		"AB" All About Soul	
Duration		"AB" 05:59	
▲ [] 7		▼	
Title		"AB" Lullabye (Goodnight, My Angel)	
Duration		"AB" 03:32	
▲ [] 8		▼	
Title		"AB" The River of Dreams	
Duration		"AB" 04:05	
▲ [] 9		▼	
Title		"AB" Two Thousand Years	
Duration		"AB" 05:19	
▲ [] 10		▼	
Title		"AB" Famous Last Words	
Duration		"AB" 05:01	

Icons for viewing and editing in Table Display

The icons shown below are available in Table Display and provide viewing and editing functionality.

	Optimizes widths of grid columns according to cell content.
---	---

	When colored, Table Display ¹⁶⁷ is on, otherwise off. Click to switch the display
	A toggle command in top left cell of table. Switches rows to columns and vice versa
	When colored, a filter ¹⁸⁴ for the table, object, or array is active, otherwise the filter is deactivated. Click to deactivate/activate. To edit the expression, double-click it
	Toggle command to word-wrap cells. When selected, word-wrap is on. By default, only the contents of items are wrapped. If you want to additionally wrap the names of items, choose this option from the icon's dropdown list.
	In an array: Append an array item to the list or table In an object: Append a <code>key:value</code> pair (as a row in a list, or (in table display) as a cell of a new table column)
	Add an empty <code>key:value</code> pair; the type of the value is <code>string</code> by default
	Select the datatype of a property value, or enter a comment or formula

Editing in Table Display

In Table Display, you can carry out the editing actions listed below.

Add rows to a table

You can add rows in the following ways:

- *Add a child row to the table:* Select the table and, in the context menu, select the command **Add Child (Ctrl+Shift+Enter)**. Alternatively, click the table's **Append Child** icon (see icon list above). A row will be appended to the bottom of the table.
- *Append a sibling row to the table when a row is selected:* Select a row and, in the context menu, select the command **Append (Ctrl+Enter)**. A row will be appended to the bottom of the table.
- *Insert a sibling row above the selected row:* Select a row and, in the context menu, select the command **Insert (Ctrl+Alt+Enter)**.

Enter or edit a property value

Select the table cell in which the property value is located and enter the value. The datatype will be automatically detected if the value is a string, number, Boolean, or null. In case of ambiguity, the type is set to `string`. You can override the automatic selection by using the datatype-selection icon (see icon list above). Alternatively, you can use an appropriate shortcut (see shortcut table below).

*	Auto (detects string, number, Boolean, null, and sets accordingly)
"	String
[Array
{	Object
/	Comment (document must be JSONC or JSON5)
=	Formula (document must be JSONC or JSON5)

Add an empty row cell in a new column

You can add a new cell to a row. The new cell will be part of a newly created column. To add the new cell, select the row you want and, in the context menu, select the command **Add Child (Ctrl+Shift+Enter)**. Alternatively, click the row's **Append Row Cell** icon (see icon list above). The row cell will be created in a new column. The type of the value in the cell is `string` by default. Enter the property's value in the cell and the property's name as the column header. The other cells in the newly created column will be empty.

Sort table rows on the values of a selected column

You can sort the rows of a table on the relative values of one of its child nodes (a column). For example, you can sort rows on the basis of the `LastName` column to give you the repeating elements of the table sorted alphabetically. To sort on a column, select the column header and then click the [Grid View toolbar](#)¹⁴⁷ command **Ascending Sort** or **Descending Sort**. These commands are also available in the [JSON menu](#)⁸⁸⁶.

Sort order in some languages, especially those with non-Latin alphabets, may benefit from enabling the beta Unicode UTF-8 support in the Language Region Settings dialog of Windows 10 (or later). Do this as follows: Go to your Windows *Settings* dialog and search for *Language Settings*. Under *Related Settings*, click *Administrative language settings*. In the Region dialog that appears, go to the *Administrative* tab, and, under *Language for non-Unicode programs*, click *Change system locale*. In the Region Settings dialog that appears (screenshot below), select the option *Beta: Use Unicode UTF-8 for worldwide language support* and click **OK**.

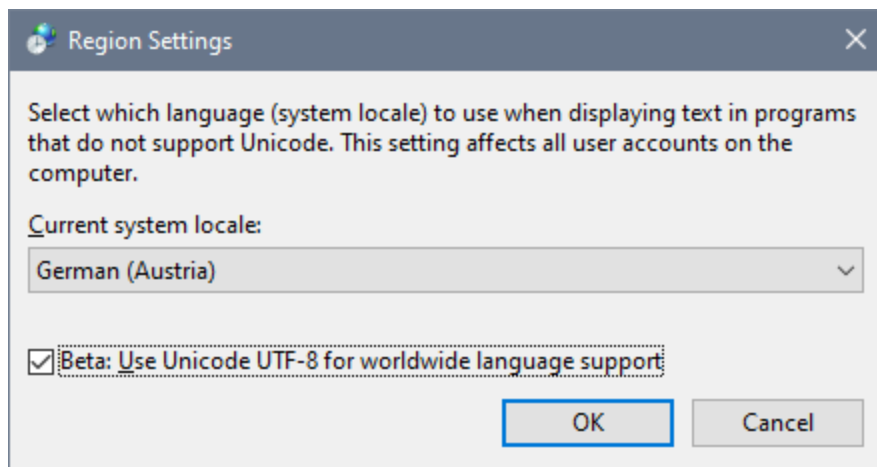

Table Display and external applications

You can take advantage of the table structure to exchange data between Table Display and a spreadsheet application (such as MS Excel). To move data from Table Display, do the following:

1. In Table Display, select the nodes you want to copy. Do this by clicking the cells themselves, column headers, row headers, or the entire table. If you click the entire table or column headers, then column headers are also copied; otherwise they are not. (In the screenshot below, rows 1 to 8 are selected, together with their column headers.)

	Title	Duration	Writer
{ } 1	"AB" Death on Two Legs	"AB" 03:43	"AB" Freddie Mercury
{ } 2	"AB" Lazing on a Sunday Afternoon	"AB" 01:08	"AB" Freddie Mercury
{ } 3	"AB" I'm in Love with My Car	"AB" 03:05	"AB" Roger Taylor
{ } 4	"AB" You're My Best Friend	"AB" 02:50	"AB" John Deacon
{ } 5	"AB" '39	"AB" 03:25	"AB" Brian May
{ } 6	"AB" Sweet Lady	"AB" 04:01	"AB" Brian May
{ } 7	"AB" Seaside Rendezvous	"AB" 02:13	"AB" Freddie Mercury
{ } 8	"AB" The Prophet's Song	"AB" 08:17	"AB" Brian May

2. Select the context menu command [Copy | Copy as Tab-separated Text](#) ⁸⁰⁶.
3. Paste the data directly into the spreadsheet program.

	A	B	C
1	Title	Duration	Writer
2	Death on Two Legs	3:43	Freddie Mercury
3	Lazing on a Sunday Afternoon	1:08	Freddie Mercury
4	I'm in Love with My Car	3:05	Roger Taylor
5	You're My Best Friend	2:50	John Deacon
6	'39	3:25	Brian May
7	Sweet Lady	4:01	Brian May
8	Seaside Rendezvous	2:13	Freddie Mercury
9	The Prophet's Song	8:17	Brian May

Data exchange works in both directions. You can also copy data from a spreadsheet to Table Display. Do this as follows:

1. Select a range in the external application and copy it to the clipboard (with **Ctrl+C**).
2. Select a single cell in Table Display.
3. Paste the copied data with **Ctrl+V**.

The data will be pasted into the table with a structure corresponding to the original structure and starting from the cell selected in Table View. The following points need to be noted:

- If the data is copied into a cell that allows new rows and/or columns to be created without invalidating currently existing data, then new rows and/or columns will be created.
- Rows are created as new objects, while columns are created as properties of the table's (row) objects.
- If the table structure cannot be validly modified, then the new data overwrites the original data of the selected cell as text.

For more complex data exchange tasks, use the unique [import/export](#) ⁹⁶¹ functions of XMLSpy.

4.3.8 Drag-and-Drop (XML)

Grid View offers a very useful drag overlay that enables you to drag an XML document fragment into Grid View from a document that is open in XMLSpy, an external application, or even a website.

When you place the cursor over the target node, a drag overlay appears that not only provides information about what is being dragged (type and number of item/s) but also information about how the item will be created when it is dropped. For example, in the screenshot below, the value `Development` is being dragged (moved). That the item is a string value is indicated by the `Abc` popup.

- If you hover over a value field (as in the screenshot at left), then the entire field is marked, indicating that the value of the marked field will be replaced by the value of the dragged field.
- If you hover over a node name (such as `Date` in the screenshot at right), then an insertion line appears, indicating that the value string will be dropped there to create a text node in the tree.

Note: You can always undo any move with **Ctrl+Z** or the menu command **Edit | Undo**.

▽	
= type	Lodging
= expto	Sales
<> Date	2003-01-01
<> expense	122.11
▽	
= type	Lodging
= expto	Development
<> Date	2003-01-02
<> expense	122.12
<> description	Played penny arcade

▽	
= type	Lodging
= expto	Sales
<> Date	2003-01-01
<> expense	122.11
▽	
= type	Lodging
= expto	Development
<> Date	2003-01-02
<> expense	122.12
<> description	Played penny arcade

Information contained in the drag overlay

The following kinds of drag overlay information will be displayed.

Normal Grid View

- Value dropped onto a value field moves the source value to overwrite the value in the target field (see *screenshot above left*).
- Value dropped into the tree as a node creates a text node (see *screenshot above right*).
- The overlay for multiple nodes of a single type shows the node type that is being dropped and the number of these nodes. Note that in order to select a node (and not its value), you must click the node's name. In the screenshot below, the information in the drag overlay indicates that two attributes will be dropped.

= type	Sales
= expto	Sales
<> Date	2003-01-01
<> expense	122.11
= type	Lodging
= expto	Development
<> Date	2003-01-02
<> expense	122.12
<> description	Played penny arcade

- The overlay for multiple nodes of different types shows the text *Mixed* and the number of nodes on the clipboard (see *screenshot below*). Note that in order to select a node (and not its value), you must click the node's name.

= type	Lodging
= expto	Sales
<> Date	2003-01-01
<> expense	122.11
= type	Lodging
= expto	Development
<> Date	2003-01-02
<> expense	122.12
<> description	Played penny arcade

Table Display

- When values are dragged, the number of selected cells are indicated by **column x rows** (see *screenshot below*). The matrix of dragged cells will replace a corresponding matrix. The target cell (the cell on which you drop the matrix) will receive the value of the top left cell of the matrix. The other dragged cells will fill the cells rightwards and downwards from the target cell. For example, in the screenshot below the blue cells are dragged and dropped onto the first **Date** cell. This results in them replacing the cells that have been marked. If the matrix of dragged cells exceeds the table boundaries, then the appropriate number of columns and/or rows is added to accommodate all dragged cells. In this case, the boundaries that will be expanded are indicated with dashed lines.

	= type	= expto	<> Date	<> expense	<> description
1	Lodging	Sales	2003-01-01	122.11	
2	Lodging	Development	2003-01-02	122.12	Played penny arcade
3	Lodging	Marketing	2003-01-02	299.45	Treated Clients
4	Entertainment	Development	2003-01-02	13.22	Bought signed "XMLSPY Handbook"

- When the target is the node tree—and not a cell—then the node being added is indicated, together with (i) the columns that will be added (contained in square brackets), and (ii) the number of rows that will be added for the new element (see screenshot below).

<> First	Fred
<> Last	Landis
<> Title	Project Manager
<> Phone	1 <> expense-item [type expto] (2)
<> Email	f.landis@nanonull.com

	= type	= expto	<> Date	<> expense	<> description
1	Lodging	Sales	2003-01-01	122.11	
2	Lodging	Development	2003-01-02	122.12	Played penny arcade
3	Lodging	Marketing	2003-01-02	299.45	Treated Clients
4	Entertainment	Development	2003-01-02	13.22	Bought signed "XMLSPY Handbook"

- A table column can be moved by selecting it (click its header to do this) and dropping it onto the column header adjacent to which you want to move it. An insertion line will indicate on which side of the target column the relocated column will be placed.

4.3.9 Drag-and-Drop (JSON)

Grid View offers a very useful drag overlay that enables you to drag a JSON document fragment into Grid View from a document that is open in XMLSpy, an external application, or even a website.

When you place the cursor over the target node, a drag overlay appears that not only provides information about what is being dragged but also information about how the item will be created when it is dropped. For example, in the screenshot below, the value `Seaside Rendezvous` is being dragged (moved). That the item is a string value is indicated by the **AB** popup.

- If you hover a value field (as in the screenshot at left), then the entire field is marked, indicating that the value of the marked field will be replaced by the value of the dragged field.
- If you hover over a node name (such as `Duration` in the screenshot at right), then an insertion line appears, indicating that the value string will be dropped there to create the value node of a key–value pair. The key in this case will be an empty string.

Note: You can always undo any move with **Ctrl+Z** or the menu command **Edit | Undo**.

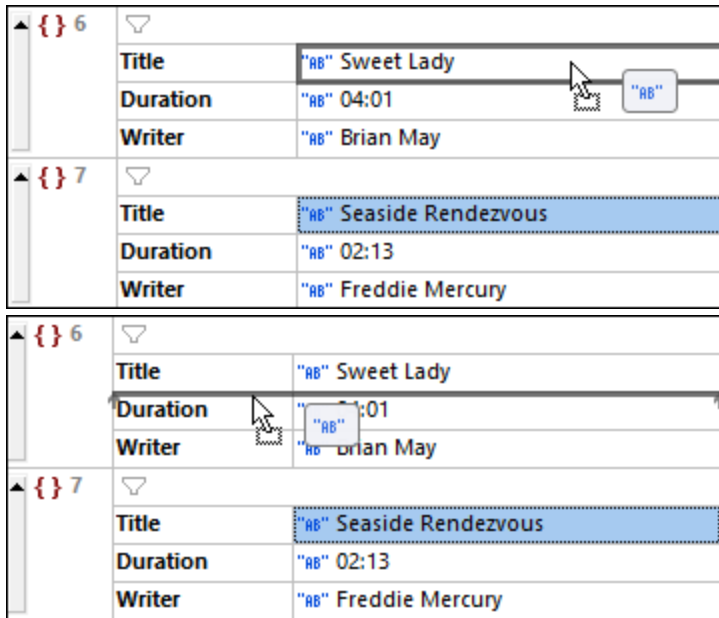

Information contained in the drag overlay

The following kinds of drag overlay information will be displayed.

Normal Grid View

- Value dropped onto a value field moves the source value to overwrite the value in the target field (see *screenshot above left*).
- Value dropped into the tree as a node creates the value node of a key–value pair (see *screenshot above right*). The key will be an empty string.
- The overlay for multiple nodes of a single type shows the node type that is being dropped and the number of these nodes. Note that in order to select a node (and not its value), you must click the node's name. In the screenshot below, the information in the drag overlay indicates that two key–value pairs of type string will be dropped.

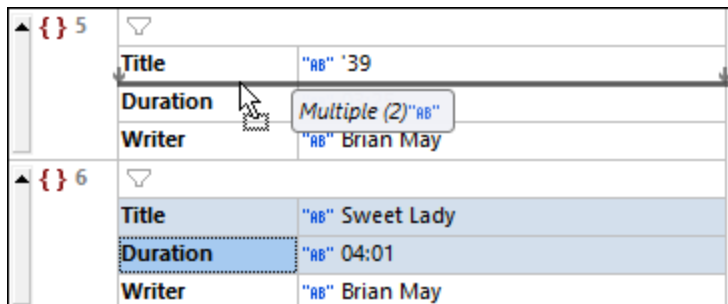

- The overlay for multiple nodes of different types shows that the new nodes will be created with a default type of string (see *screenshot below*). You can change the type of the dropped nodes by clicking the respective *Edit Type* icons. Note that in order to select a node (and not its value), you must click the node's name.

itemID	"AB" 1
displayName	Multiple (2)"AB"
price	# 0.79
quantity	# 3
f(x) subTotal	2.37
itemID	"AB" 2
displayName	"AB" Yogurt
price	# 0.59
quantity	# 2
f(x) subTotal	1.18

Table Display

- When values are dragged, the number of selected cells are indicated by **column x rows** (see screenshot below). The matrix of dragged cells will replace a corresponding matrix. The target cell (the cell on which you drop the matrix) will receive the value of the top left cell of the matrix. The other dragged cells will fill the cells rightwards and downwards from the target cell. For example, in the screenshot below the blue cells are dragged and dropped onto the **Duration** cell of row 6. This results in them replacing the cells that have been marked. If the matrix of dragged cells exceeds the table boundaries, then the appropriate number of columns and/or rows is added to accommodate all dragged cells. In this case, the boundaries that will be expanded are indicated with dashed lines.

{ } 5	"AB" '39	"AB" 03:25	"AB" Brian May
{ } 6	"AB" Sweet Lady	"AB" 04:01	"AB" Brian May
{ } 7	"AB" Seaside Rendezvous	"AB" 02:13	"AB" Freddie Mercury
{ } 8	"AB" The Prophet's Song	"AB" 08:17	"AB" Brian May
{ } 9	"AB" Love of My Life	"AB" 03:38	"AB" Freddie Mercury
{ } 10	"AB" Good Company	"AB" 03:26	"AB" Brian May

- When the target is the node tree—and not a cell—then the node being added is indicated, together with (i) the columns that will be added (contained in square brackets), and (ii) the number of instances of the new item. For example, in the screenshot below, an array is added that contains two objects, each of which has a **Title**, **Duration**, and **Writer** key-value pair.

	Title	Duration	Writer
{ } 1	"AB" Death on Two Legs	"AB" 03:43	"AB" Freddie Mercury
{ } 2	"AB" [Title Duration Writer] (2)	"AB" 01:08	"AB" Freddie Mercury
{ } 3	"AB" I'm in Love with My Car	"AB" 03:05	"AB" Roger Taylor
{ } 4	"AB" You're My Best Friend	"AB" 02:50	"AB" John Deacon
{ } 5	"AB" '39	"AB" 03:25	"AB" Brian May
{ } 6	"AB" Sweet Lady	"AB" 04:01	"AB" Brian May
{ } 7	"AB" Seaside Rendezvous	"AB" 02:13	"AB" Freddie Mercury
{ } 8	"AB" The Prophet's Song	"AB" 08:17	"AB" Brian May

- A table column can be moved by selecting it (click its header to do this) and dropping it onto the column header adjacent to which you want to move it. An insertion line will indicate on which side of the target column the relocated column will be placed.

4.3.10 Formulas (XML)

A formula in XML Grid View uses an XQuery 3.1 expression to calculate a result or generate a nodeset that can be stored in the document. A formula is defined with an XQuery 3.1 expression. For example, in the screenshot below, a formula named `MinTemps` has been created that generates the minimum, maximum, and average of the set of all minimum temperatures.

<> Month (12)	= name	<> Min	<> Max
1	January	-5	3
2	February	-16	1
3	March	-9	7
4	April	2	16
5	May	8	21
6	June	12	26
7	July	14	34
8	August	16	36
9	September	11	28
10	October	10	26
11	November	-1	14
12	December	-3	9

f(x) MinTemps	concat(" MinMin=", min(Month/Min), ", ", " MaxMin=", max(Month/Min), ", ", " AvgMin=", avg(Month/Min))
Abc	MinMin=-16, MaxMin=16, AvgMin=3.25

To create a formula, do the following:

1. Add a new node where you want to display the formula.
2. The node will be created by default as an element. [Change the type of the node](#)¹⁵⁶ to Formula.
3. Double-click in the cell containing the `f(x)` icon and enter the name of the formula (see screenshot above).
4. You can click this icon to save the output of the formula to the document.
5. Double-click in the expression's cell and type in the XQuery expression, then click **Enter**.

Listing of XML document used in the screenshot above

```
<?xml version="1.0" encoding="UTF-8"?>
<Temperatures>
  <Month name="January">
    <Min>-5</Min>
    <Max>3</Max>
```

```

</Month>
<Month name="February">
  <Min>-16</Min>
  <Max>1</Max>
</Month>
<Month name="March">
  <Min>-9</Min>
  <Max>7</Max>
</Month>
<Month name="April">
  <Min>2</Min>
  <Max>16</Max>
</Month>
<Month name="May">
  <Min>8</Min>
  <Max>21</Max>
</Month>
<Month name="June">
  <Min>12</Min>
  <Max>26</Max>
</Month>
<Month name="July">
  <Min>14</Min>
  <Max>34</Max>
</Month>
<Month name="August">
  <Min>16</Min>
  <Max>36</Max>
</Month>
<Month name="September">
  <Min>11</Min>
  <Max>28</Max>
</Month>
<Month name="October">
  <Min>10</Min>
  <Max>26</Max>
</Month>
<Month name="November">
  <Min>-1</Min>
  <Max>14</Max>
</Month>
<Month name="December">
  <Min>-3</Min>
  <Max>9</Max>
</Month>
</Temperatures>

```

▣ Listing of formula expression used in the screenshot above

```

concat(
  " MinMin=", min(//Month/Min), ", ",

```

```
" MaxMin=", max(//Month/Min), ", ", ", ",
" AvgMin=", avg(//Month/Min)
)
```

Note the following points:

- The context node of the formula's XQuery expression is the parent node of the formula node.
- To add a new line in an expression, press **Ctrl+Enter**. This is useful if you want to display an expression over several lines for better readability.
- The XQuery expressions of a document's formulas are stored in a special application metadata file located in your [\(My\) Documents folder](#)²⁸: `Altova\XMLSpyCommon\json-metadata.json`. Formulas will automatically be applied from this file when the document is re-opened in Grid View.
- Formula expressions can additionally be saved as processing instructions in the document file itself when the document is saved. To do this, make sure that the *Persistence* option of Grid View Settings ([Tools | Options | View | Grid View Settings](#)¹⁰⁵³) has been selected.
- In Grid View, the result generated by a formula is displayed in the cell below the formula's XQuery expression and also stored in the application metadata file (see above).
- If the *Persistence* option has been selected (see above), then a disk icon appears next to the XQuery expression. Toggle this icon on to save the formula's result in the document.
- The formula's result will be stored as the content of an element which has the name you assigned the formula. For example: for the `MinTemps` formula shown in the screenshot above, the result will be stored in an element named `MinTemps`.
- Whether the formula's result is stored in the document or not, it will be calculated and stored in the application metadata file (see above).

Formulas in tables

If all the cells of a table column (in [Table Display](#)¹⁶³) contain the same formula, then the formula is displayed only once—in the header of the column (see *screenshot below*). The *results* of the formula calculation, however, are displayed in the respective cells. The formula in the column header is a Grid View representation. In the XML document (see Text View), the formula is repeated for each table-row item.

The screenshot shows a table with 12 rows and 5 columns. The header row is highlighted in yellow and contains the following text: `<> Month (12)`, a small icon, `= name`, `<> Min`, `<> Max`, `f(x) MidRange`, and `(Min + Max) div 2`. The data rows contain the following values:

	<code>= name</code>	<code><> Min</code>	<code><> Max</code>	<code>f(x) MidRange</code>	<code>(Min + Max) div 2</code>
1	January	-5	3	#	-1
2	February	-16	1	#	-7.5
3	March	-9	7	#	-1
4	April	2	16	#	9
5	May	8	21	#	14.5
6	June	12	26	#	19
7	July	14	34	#	24
8	August	16	36	#	26
9	September	11	28	#	19.5
10	October	10	26	#	18
11	November	-1	14	#	6.5
12	December	-3	9	#	3

If even a single formula of a cell is different, then the formula of each cell will be displayed. If all formulas of a table column are the same so that the formula appears in the header, and you now want to create a different

formula for an individual cell, switch off Table Display and edit the formula of that cell. When you switch back to Table Display, formulas will be displayed in individual cells (for all cells).

4.3.11 Formulas (JSON)

A formula is an XQuery 3.1 expression that generates output (either a nodeset or a calculations) for display in JSON Grid View. In the screenshot below, for example, the total price of the items 1 to 4 is calculated and the output (28) is displayed in a separate line. Each formula is executed independently and is not affected by other filters or formulas in the document.

For information about constructing XQuery expressions for JSON documents, see the section [XQuery Expressions for JSON](#)⁵⁶⁷.

receiptID	"RB" 123-456-7890																												
paymentMethod	"RB" Cash																												
items	<table border="1"> <thead> <tr> <th></th> <th>itemID</th> <th>displayName</th> <th>price</th> <th>quantity</th> </tr> </thead> <tbody> <tr> <td>{ } 1</td> <td>"RB" 1</td> <td>"RB" Milk</td> <td># 1</td> <td># 3</td> </tr> <tr> <td>{ } 2</td> <td>"RB" 2</td> <td>"RB" Yogurt</td> <td># 2</td> <td># 2</td> </tr> <tr> <td>{ } 3</td> <td>"RB" 3</td> <td>"RB" Chocolate 85%</td> <td># 1</td> <td># 1</td> </tr> <tr> <td>{ } 4</td> <td>"RB" 4</td> <td>"RB" Fancy Wine</td> <td># 20</td> <td># 1</td> </tr> </tbody> </table>					itemID	displayName	price	quantity	{ } 1	"RB" 1	"RB" Milk	# 1	# 3	{ } 2	"RB" 2	"RB" Yogurt	# 2	# 2	{ } 3	"RB" 3	"RB" Chocolate 85%	# 1	# 1	{ } 4	"RB" 4	"RB" Fancy Wine	# 20	# 1
	itemID	displayName	price	quantity																									
{ } 1	"RB" 1	"RB" Milk	# 1	# 3																									
{ } 2	"RB" 2	"RB" Yogurt	# 2	# 2																									
{ } 3	"RB" 3	"RB" Chocolate 85%	# 1	# 1																									
{ } 4	"RB" 4	"RB" Fancy Wine	# 20	# 1																									
f(x) totalPrice	<pre>sum(for \$item in ?items?* return \$item?price * \$item?quantity) # 28</pre>																												

- JSON document shown in screenshot above, including stored formula and formula result

Note that the **formula** is stored as a JSON comment, but the **formula result** is stored as straight JSON code. The code below (with the formula output being stored) is a result of the formula's disk icon being clicked.

```
{
  "receiptID": "123-456-7890",
  "paymentMethod": "Cash",
  "items": [
    {
      "itemID": "1",
      "displayName": "Milk",
      "price": 1,
      "quantity": 3
    },
    {
      "itemID": "2",
      "displayName": "Yogurt",
      "price": 2,
      "quantity": 2
    },
    {
      "itemID": "3",
```



```
        "displayName": "Chocolate 85%",
        "price": 1,
        "quantity": 1
    },
    {
        "itemID": "4",
        "displayName": "Fancy Wine",
        "price": 20,
        "quantity": 1
    }
],
//(:altova_xq_embed:)totalPrice(:altova_xq_key:)sum(for $item in ?items?* return
$item?price * $item?quantity)
"totalPrice": 28
//(:altova_xq_end:)
}
```

In the screenshot above, the formula sums up the members of a sequence. These members are each the product of the `price` and `quantity` values of each object contained in the `items` array. The iteration to select each object and assign it in turn to the `$item` variable is specified by: `for $item in ?items?*`. It is important at this point to note the context node, which is the parent of the formula—and, consequently, the parent of the `items` node. Each product is obtained by looking up the `price` and `quantity` child nodes of the object currently in the `$item` variable, and multiplying these two values with one another. The products obtained in this way are the members of the sequence, which are then summed to generate the total price.

Create a formula

To create a formula, do the following:

1. Select the node to which you want to add the formula, either as a sibling or child. Right-click, and add the sibling or child (whichever you want). In deciding where you want the formula to appear (as sibling or child), bear in mind that the context node of the formula's XQuery expression will be the parent node of the formula. For example, in the XQuery expression shown in the screenshot above, the context node is the parent node of the formula (`totalPrice`) and of its sibling, the `items` array. To create the formula in the screenshot above, a sibling node was appended to the `items` array (see *screenshot below*).
2. Change the type of the node to Formula (see *screenshot below*).

	itemID	displayName	price	quantity
{ } 1	"AB" 1	"AB" Milk	# 1	# 3
{ } 2	"AB" 2	"AB" Yogurt	# 2	# 2
{ } 3	"AB" 3	"AB" Chocolate 85%	# 1	# 1
{ } 4	"AB" 4	"AB" Fancy Wine	# 20	# 1

3. Double-click in the cell containing the $f(x)$ icon to enter the name of the formula (see screenshot below). If the document is a JSON5 or JSONC document, then a disk icon is displayed. You can click this icon to save the output of the formula to the document.

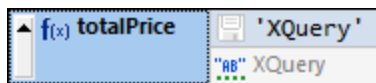



4. By default, the XQuery expression is the string `'xQuery'`, so the output will be the string `xQuery` (displayed in the cell below the expression). Enter your XQuery expression by double-clicking in the expression's cell, typing in the expression, and then clicking **Enter**. This causes the formula to be evaluated and its result to be displayed. Other formulas will not be modified.
5. If there are multiple formulas in the document, click the menu command **JSON | Re-evaluate All** to update the results of all formulas. This command is especially useful if formulas in the document look up dynamically changing data (for example, exchange rates).

Summary of key points

Note the following points about formulas, especially the special properties of **JSON5** and **JSONC** documents:

- The context node of the formula's XQuery expression is the parent node of the formula node.
- To add a new line in an expression, press **Ctrl+Enter**. This is useful if you want to display an expression over several lines for better readability.
- The XQuery expressions of a document's formulas are stored in a special application metadata file located in your [\(My\) Documents folder](#)²⁸: `Altova\XMLSpyCommon\json-metadata.json`. Formulas will automatically be applied from this file when the document is re-opened in Grid View.
- In JSON5 and JSONC documents, you can additionally save formulas as comments. Do this by selecting the *Persistence* option of Grid View Settings ([Tools | Options | View | Grid View Settings](#)¹⁰⁵⁵). This option is selected by default.
- The calculation result of a formula is displayed in the cell below the formula's XQuery expression. In the case of JSON5 and JSONC, the output can additionally be stored in the document. If the *Persistence*

option has been selected (see *previous point*), then a disk icon appears next to the XQuery expression. Toggle this icon on to save the formula's result in the document.

	Formula output not saved to JSON content; click to save. <i>Only in JSON5 and JSONC.</i>
	Formula output saved to JSON content; click to not save. <i>Only in JSON5 and JSONC</i>

- Whether the disk is clicked or not, the formula's output will be calculated and stored in the document's metadata.
- When the output is a calculation and is stored in content, it is stored as a property which has the name you assigned the formula. For example, in the `totalPrice` formula described above, the output will be stored like this: `"totalPrice": 28`.
- Note this difference: In JSON5 and JSONC documents, formulas are saved as JSON comments, their outputs are saved as JSON properties.

Note: It is not possible to save either formulas or their results in JSON documents that are not JSON5 or JSONC. However, since the Grid View formulas of any JSON document are always stored in the application metadata file, they will always be applied to the document when the document is displayed in Grid View.

Formulas in tables

If all the cells of a table column (in [Table Display](#)¹⁶⁷) contain the same formula, then the formula is displayed only once—in the header of the column (see *screenshot below*). The *results* of the formula calculation, however, are displayed in the respective cells. The formula in the column header is a Grid View representation. In the JSON document content (in Text View), the formula is repeated for each table-row item.

```
// This file demonstrates the new features in JSON Grid View.
// Switch to Grid View to enjoy new features like filters and formulas.
```

receiptID "RB" 123-456-7890						
paymentMethod "RB" Cash						
items						
	itemID	displayName	price	quantity	f(x) subTotal	 ?price * ?quantity
{}	"RB" 1	"RB" Milk	# 0.79	# 3	# 2.37	
{}	"RB" 2	"RB" Yogurt	# 0.59	# 2	# 1.18	
{}	"RB" 3	"RB" Chocolate 85%	# 2.99	# 1	# 2.99	
{}	"RB" 4	"RB" Fancy Wine	# 20.00	# 1	# 20	
f(x) totalPrice	sum(for \$item in ?items?* return \$item?price * \$item?quantity)					# 26.54

If even a single formula is different (as in the highlighted cell of the screenshot below), then each formula is displayed in its respective cell.

```
// This file demonstrates the new features in JSON Grid View.
// Switch to Grid View to enjoy new features like filters and formulas.
```

receiptID	"RB" 123-456-7890																																		
paymentMethod	"RB" Cash																																		
items	<table border="1"> <thead> <tr> <th></th> <th>itemID</th> <th>displayName</th> <th>price</th> <th>quantity</th> <th>f(x) subTotal</th> </tr> </thead> <tbody> <tr> <td>{ } 1</td> <td>"RB" 1</td> <td>"RB" Milk</td> <td># 0.79</td> <td># 3</td> <td> ▲ f(x) subTotal # ?price * ?quantity # 2.37 </td> </tr> <tr> <td>{ } 2</td> <td>"RB" 2</td> <td>"RB" Yogurt</td> <td># 0.59</td> <td># 2</td> <td> ▲ f(x) subTotal # ?price * ?quantity # 1.18 </td> </tr> <tr> <td>{ } 3</td> <td>"RB" 3</td> <td>"RB" Chocolate 85%</td> <td># 2.99</td> <td># 1</td> <td> ▲ f(x) subTotal # ?price * ?quantity # 2.99 </td> </tr> <tr> <td>{ } 4</td> <td>"RB" 4</td> <td>"RB" Fancy Wine</td> <td># 20.00</td> <td># 1</td> <td> ▲ f(x) subTotal # ?price * ?quantity * 1.2 # 24 </td> </tr> </tbody> </table>						itemID	displayName	price	quantity	f(x) subTotal	{ } 1	"RB" 1	"RB" Milk	# 0.79	# 3	▲ f(x) subTotal # ?price * ?quantity # 2.37	{ } 2	"RB" 2	"RB" Yogurt	# 0.59	# 2	▲ f(x) subTotal # ?price * ?quantity # 1.18	{ } 3	"RB" 3	"RB" Chocolate 85%	# 2.99	# 1	▲ f(x) subTotal # ?price * ?quantity # 2.99	{ } 4	"RB" 4	"RB" Fancy Wine	# 20.00	# 1	▲ f(x) subTotal # ?price * ?quantity * 1.2 # 24
	itemID	displayName	price	quantity	f(x) subTotal																														
{ } 1	"RB" 1	"RB" Milk	# 0.79	# 3	▲ f(x) subTotal # ?price * ?quantity # 2.37																														
{ } 2	"RB" 2	"RB" Yogurt	# 0.59	# 2	▲ f(x) subTotal # ?price * ?quantity # 1.18																														
{ } 3	"RB" 3	"RB" Chocolate 85%	# 2.99	# 1	▲ f(x) subTotal # ?price * ?quantity # 2.99																														
{ } 4	"RB" 4	"RB" Fancy Wine	# 20.00	# 1	▲ f(x) subTotal # ?price * ?quantity * 1.2 # 24																														
f(x) totalPrice	<pre>sum(for \$item in ?items?* return (if (\$item?displayName="Fancy Wine") then (\$item?price * \$item?quantity * 1.2) else \$item?price * \$item?quantity)) # 30.54</pre>																																		

Re-evaluate all formulas

To update the results of all formulas in the document, click the menu command **JSON | Re-evaluate All**.

Procedures for relevant actions

- Add a new empty column to the table as follows: Switch to List Display from Table Display, right-click any `key:value` pair in the list display, and append or insert a new `key:value` pair via the item's context menu. When you switch back to Table Display, a new column is created for the new `key:value` pair that was appended/inserted. You can now edit this column in Grid View.
- If all formulas of a table column are the same so that the formula appears in the header and you now want to create a different formula for an individual cell, switch to List Display and edit the formula of that cell.

4.3.12 Filters

Filters in XML documents

A filter in XML Grid View can be applied to an element node and enables you to filter the descendants of that node. Wherever a filter can be applied, a grayed out filter icon is displayed. Once a filter has been defined, this icon is shown in color (see screenshot below). A filter is defined with an XQuery 3.1 expression. For example, in the screenshot below, a filter has been set on the `Temperatures` node to display only those `Month` child elements that have a `Min` child element with a value that is greater than 10. (Note that in the screenshot the index number of the respective `Month` element instance is listed.)

	name	Min	Max
6	June	12	26
7	July	14	34
8	August	16	36
9	September	11	28

To set up a filter, right-click the element you want to filter, select **Filter** from the context menu that appears, enter the XQuery expression, and click **Enter**. The *Filter* cell is indicated by the icon  (see *screenshot above*). You can activate/deactivate the filter by clicking the *Filter* icon.

 *Listing of XML document used in the screenshot above*

```
<?xml version="1.0" encoding="UTF-8"?>
<Temperatures>
  <Month name="January">
    <Min>-5</Min>
    <Max>3</Max>
  </Month>
  <Month name="February">
    <Min>-16</Min>
    <Max>1</Max>
  </Month>
  <Month name="March">
    <Min>-9</Min>
    <Max>7</Max>
  </Month>
  <Month name="April">
    <Min>2</Min>
    <Max>16</Max>
  </Month>
  <Month name="May">
    <Min>8</Min>
    <Max>21</Max>
  </Month>
  <Month name="June">
    <Min>12</Min>
    <Max>26</Max>
  </Month>
  <Month name="July">
    <Min>14</Min>
    <Max>34</Max>
  </Month>
  <Month name="August">
    <Min>16</Min>
    <Max>36</Max>
  </Month>
  <Month name="September">
```

```

    <Min>11</Min>
    <Max>28</Max>
  </Month>
  <Month name="October">
    <Min>10</Min>
    <Max>26</Max>
  </Month>
  <Month name="November">
    <Min>-1</Min>
    <Max>14</Max>
  </Month>
  <Month name="December">
    <Min>-3</Min>
    <Max>9</Max>
  </Month>
</Temperatures>

```

Note the following points about filters:

- Filters can be applied only to element nodes.
- The context node of the filter's XQuery expression is the current node. In the screenshot above, for example, the context node is the `Temperatures` node.
- Filters can be nested. A nested filter will be applied to the filtered content of the parent filter.
- Each filter is executed independently and is not affected by [formulas](#)¹⁷⁷ or other filters (unless it is a nested filter).
- To add a new line in an expression, press **Ctrl+Enter**. This is useful if you want to display an expression over several lines for better readability.
- The filtered content is a visual display only. The actual content remains unchanged.
- After a filter has been created, it can be deactivated/reactivated via the node's context menu **Filter** command.
- Filters are **not stored** in the XML document, but are kept in a special application metadata file located in your [\(My\) Documents folder](#)²⁸: `Altova\XMLSpyCommon\json-metadata.json`. Filters will be automatically applied from this file when the document is re-opened in Grid View. You can pass the metadata file to other XMLSpy users so that they can use the same filters.

Filters in JSON documents

Filters enable you to filter the display of objects and arrays. For example, in the screenshot below, a filter (which is an XQuery 3.1 expression) has been applied to an array so that only those tracks written by Brian May are displayed. In JSON terms, only those object children of `Tracks` are displayed that have a `writer` property containing the string value `Brian May`. The filter's XQuery expression looks up all child objects of `Tracks` and selects those for which a lookup of the `writer` property matches the string `'Brian May'`.

The screenshot shows the XMLSpy Grid View for a JSON document. The root element is `Tracks`, and a filter `?*[?Writer='Brian May']` is applied. The grid displays four track objects, each with a `writer` property set to `Brian May`.

	Title	Duration	Writer
{ } 5	"AB" '39	"AB" 03:25	"AB" Brian May
{ } 6	"AB" Sweet Lady	"AB" 04:01	"AB" Brian May
{ } 8	"AB" The Prophet's Song	"AB" 08:17	"AB" Brian May
{ } 10	"AB" Good Company	"AB" 03:26	"AB" Brian May

Each filter is executed independently and is not affected by other filters or [formulas](#)¹⁷⁷ in the document.

For information about constructing XQuery expressions for JSON documents, see the section [XQuery Expressions for JSON](#)⁶⁶⁷.

Note: When entering expressions for filters and formulas in Grid View, you might want to display an expression over several lines for better readability. To add a new line in the expression, press **Ctrl+Enter**.

Set up a filter

To set up a filter, right-click the element you want to filter, select **Filter** from the context menu that appears, enter the XQuery expression, and click **Enter**. The *Filter* cell is indicated by the icon  (see *screenshot above*). You can activate/deactivate the filter by clicking the *Filter* icon.

Note the following points about filters:

- Filters can be applied only to objects and arrays.
- The context node of the filter's XQuery expression is the current node. In the screenshot above, for example, the context node of the filter's XQuery expression is the **Tracks** node.
- Filters can be nested. A nested filter will be applied to the filtered content of the parent filter.
- Each filter is executed independently and is not affected by [formulas](#)¹⁷⁷ or other filters (unless it is a nested filter).
- To add a new line in an expression, press **Ctrl+Enter**. This is useful if you want to display an expression over several lines for better readability.
- The filtered content is a visual display only. The actual content remains unchanged.
- After a filter has been created, it can be deactivated/reactivated via the node's context menu **Filter** command.
- Filters are **not stored** in the XML document, but are kept in a special application metadata file located in your [\(My\) Documents folder](#)²⁸: `Altova\XMLSpyCommon\json-metadata.json`. Filters will be automatically applied from this file when the document is re-opened in Grid View. You can pass the metadata file to other XMLSpy users so that they can use the same filters.

4.3.13 Images

Images can be displayed directly in Grid View in its graphical representation (see *screenshots below: XML Grid View at left, JSON Grid View at right*). In order for this to happen, the image must be stored in the file in its Base64-encoding (and not as a reference to an image file)

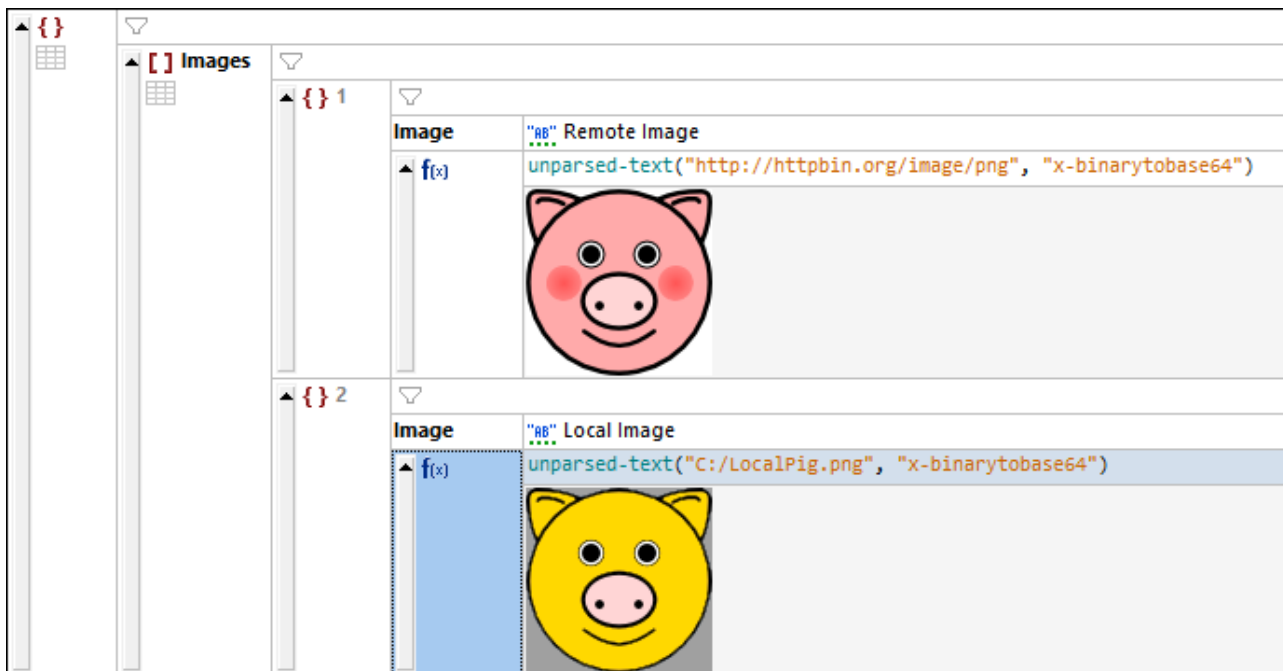
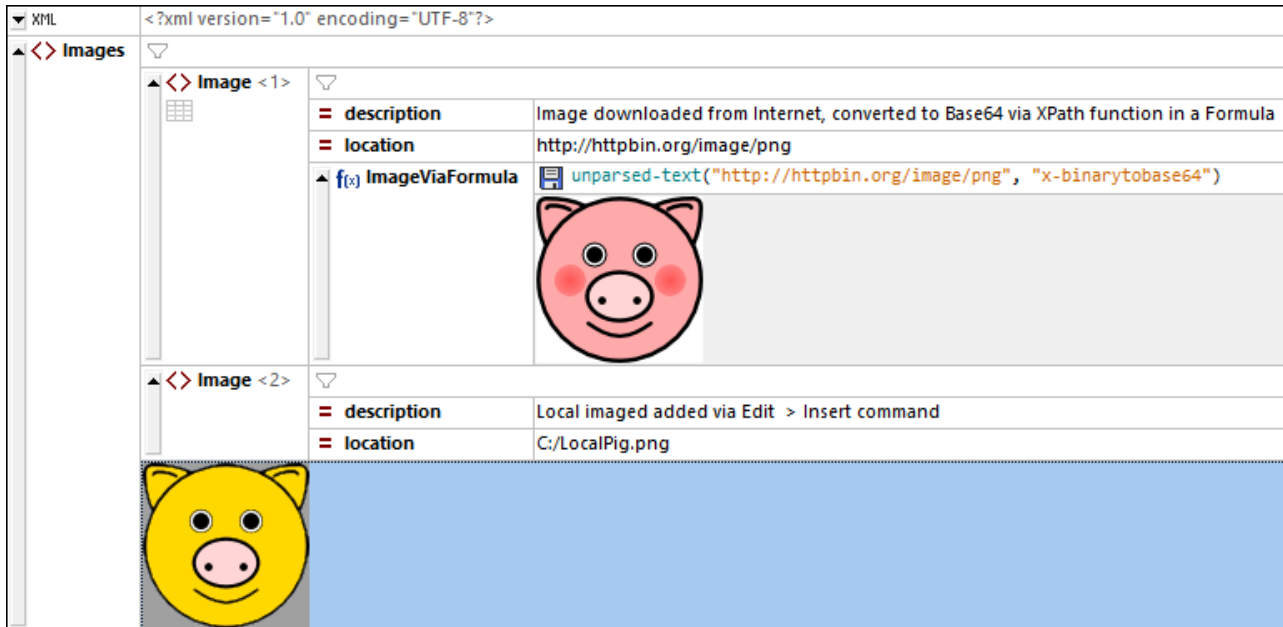

There are two ways to insert the Base64-encoding of an image in a Grid View cell:

- Create a node that is of type *Formula*. In the formula expression cell (see screenshot above), enter the following XPath expression to convert an image to its Base64 encoding: `unparsed-text("<Image-URL>", "x-binarytobase64")`. The XPath function `unparsed-text` converts the image to Base64 encoding. The image will be stored as Base64-encoded text (which you can see in Text View), but will be rendered in its graphic form below the cell containing the formula expression.
- Place the cursor in the cell into which you want to add the image. For example, in the screenshot above, the image is added as content of the second `Image` element by selecting the `Image` element.

Then select **Edit | Insert | Encoded External File**. In the dialog that appears: (i) enter the path to the image you want (local or internet), (ii) select *Base 64*, (iii) select *Create Text*. The image will be converted to its Base64 encoding, and the encoded text will be entered as text in the selected node. (In XML Grid View, you can alternatively create the Base64 text as a new child element.) You can see the encoded text in Text View. However, in Grid View, you will see, not the encoding, but a rendering of the image in the cell (see *screenshot above*).

Image URLs can be given in the following forms, including as relative paths:

- `http://httpbin.org/image/png`
- `file:///c:/LocalPig.png`
- `C:/LocalPig.png`
- `LocalPig.png`

Most of the image formats that are commonly used are supported. These include PNG, JPEG, BMP, and animated GIFs. SVG is read as an XML document; in Grid View, the image is displayed as the last child of the `<svg>` element.

Save a Base64-encoded image string as an image file

The Base64 encoding of an image is simple text. In XMLSpy, you can generate this text into an image file having the image format that is encoded in the Base64 text string. To save a Base64-encoded string in its image format, right-click the image or its cell and select the command **Save as Image**. (Note that, although the image is displayed in Grid View as an image, it is actually stored in the file as a Base64 string.) In the dialog that appears, select the location where you want to save the image and enter a name for the image file. The extension of the image file (`.png`, `.gif`, `.svg`, etc) will be auto-detected from the Base64 encoding and will appear in the Save dialog. Click **Save** when done.

This action can also be carried out via the **Edit | Save as Image** menu command.

4.3.14 Context Menu

When you right-click a cell in Grid View, a context menu (*screenshot below*) appears that provides commands for editing content related to the cell and for modifying the display. The context menu can also be accessed by pressing the keyboard's **Menu** key. The commands of the context menu are described below.

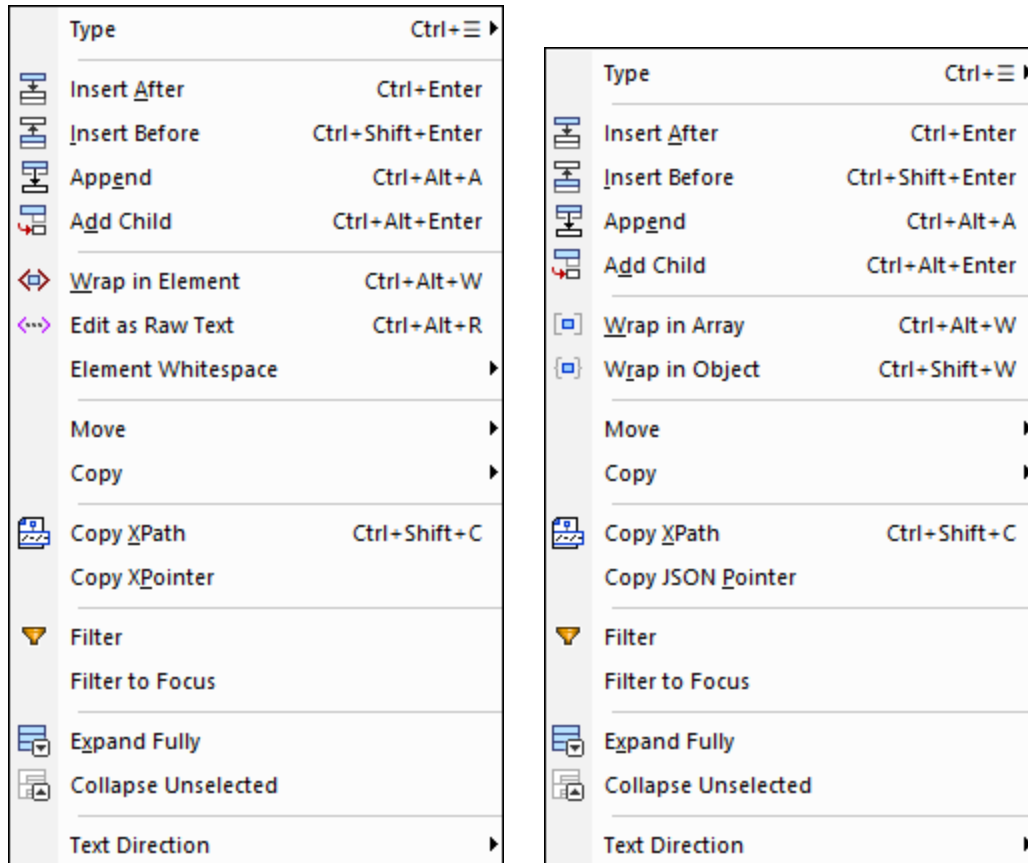

Type

Hovering over the **Type** command causes a sub-menu to be displayed in which you can select the [type of the component](#)¹⁴⁷. You can also directly access the **Type** sub-menu via the keyboard shortcut **Ctrl+Menu**.

Insert After/Before, Append, Add Child

The **Insert** and **Append** commands add an item at the same level. (In XML, this is by default an element.) The new item is added, in the case of **Insert After** and **Insert Before**, respectively, after and before the selected item, and in the case of **Append** as the last sibling of the selected item.

The **Add Child** command appends a new item as a child:

- In XML, the child item is by default an element. Change the name of the newly added element by double-clicking in its name cell and editing. Change the node type by clicking the element's icon (to the left of its name) and selecting the node type you want.
- In JSON, if a child already exists, the new child will be of the same type as the last child; if no child exists, then the new child will be an empty `key:value` pair.

Wrap in Element (XML Grid View)

The selected item is given a parent element with a default element, which you can rename (by double-clicking the name and editing it).

Edit as Raw Text (XML Grid View)

Enables you to edit text content of the selected item as raw text. This is useful, for instance, if you are editing complex content such as HTML code. For example, the screenshot below, shows the `Address` element in Grid View.



Property	Value
<code>xsi:type</code>	US-Address
<code>Name</code>	US dependency
<code>Street</code>	Noble Ave.
<code>City</code>	Dallas
<code>Zip</code>	04812
<code>State</code>	Texas

If you switch the display of the `Address` element to raw text (screenshot below), the grid structure is converted to a single item containing raw text, all of which can be edited as in Text View.

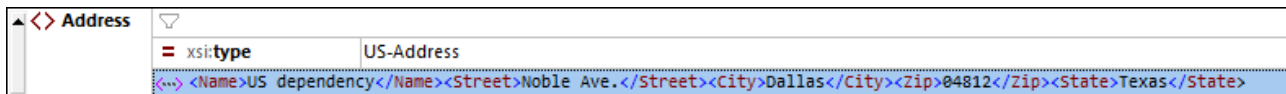

Property	Value
<code>xsi:type</code>	US-Address
<code><Name>US dependency</Name><Street>Noble Ave.</Street><City>Dallas</City><Zip>04812</Zip><State>Texas</State></code>	

Element Whitespace (XML Grid View)

Available on element nodes, it adds the `xml:space` attribute to the element's markup and gives this attribute the value you select from the command's submenu.

- However, if you select the *Omit* value, then the `xml:space` attribute is not added, which has the effect of normalizing whitespace.
- The *Preserve* value preserves all whitespace as is and turns off [pretty printing](#)¹³¹ for that element. Preserved whitespace is indicated in Grid View by an ellipsis icon.
- The *Default* value takes the value specified for that element in the schema, which can be useful for overriding an `xml:space` value that has been inherited from an ancestor element in the XML document.

Wrap in Array. Wrap in Object (JSON Grid View)

The selected part of the table can be wrapped in either an array or an object.

Move Up/Down/Left/Right

If it is possible to move a component up, down, left or right from its current location in the grid, then the corresponding command/s are enabled. Select the respective command to carry out the move.

Copy

These commands can be used to copy the current selection. Only those options are enabled that are allowed on that component.

Command	Description
Copy as XML/JSON Text	Current selection is serialized as XML/JSON markup
Copy as Tab-separated Text	Current table selection is serialized as TSV (Tab-Separated Values)
Copy as Image	Current image cell is copied as image

Note the following points:

- *Copy as Image* copies the Base64-encoded string of the selected image. If the string is pasted to a document where the Base64-encoded string can be rendered as an image (for example to another table cell in Table Display), then it will be rendered. Otherwise, it will be pasted as a string.
- To insert text in a cell, copy the text and paste it in the cell.
- To import from file, for example an image, use the command [Edit | Insert | Encoded External File](#)⁸⁰⁷. This inserts an image as Base64-encoded string, and displays this string as an image in JSON Grid View. Image file formats that are supported for import are: PNG, JPEG, BMP, GIF, TIFF.

Copy XPath

This command copies to the clipboard an XPath 3.1 locator expression, starting at the document root, that locates the selected node.

Copy XPointer (XML Grid View)

This command copies to the clipboard an XPointer expression that locates the selected node. See [Copy XPointer/JSON-Pointer](#)⁸⁰⁷ for details.

Copy JSON Pointer (JSON Grid View)

This command copies to the clipboard a JSON Pointer expression that locates the selected node. For example: `/Artists/1/Albums/1/Tracks`. See [Copy XPointer/JSON-Pointer](#)⁸⁰⁷ for more information.

Filter, Filter to Focus

The **Filter** command is a toggle command. It adds a filter to the selected element or deactivates a filter. Note that, after you add a filter via this command, you must enter a filter expression; otherwise the filter will automatically be removed. After a filter has been added you can deactivate it by selecting the command again or clicking the filter. To remove the filter, click *Remove all filters* in the toolbar.

The **Filter to Focus** command (i) builds a filter on the root element which contains an XPath expression to locate the selected node, and (ii) filters the Grid View display to show the selected node (and its descendants) directly under the root element. This is useful if you want to focus the display on just the selected node. To remove the filter, click the Filter icon in the content cell of the root element.

Expand Fully

This command is enabled if the selected component or any of its descendants is collapsed. It expands the component and all descendant components.

Collapse Unselected

This command collapses all components except the selected component and its ancestor components.

Text Direction

This command is available for nodes containing text (or, in JSON, a String type), and switches the reading order to start from either the left or the right of the cell. This is useful when using languages such as Arabic and Hebrew.

4.3.15 Grid View Settings

The settings of Grid View are defined in the Grid View Settings dialog (*screenshot below*), which is accessed via the Settings icon in the [Grid View toolbar](#)¹⁴⁷.

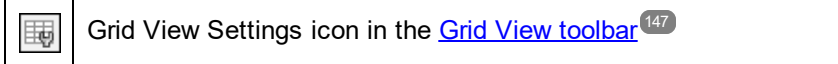

Grid View settings are described below. Note that these settings apply to the Grid View of all documents (XML, JSON, DTD).

Grid View Settings [X]

Display

- Expand all cells on loading
- Convert XML entities to Raw text on loading
- Show inline previews for attributes only in XML
- Automatically provide optimal cell widths
- Limit optimal cell width to pixels
- Limit cell height to pixels
- Display of text overflow:
- Display whitespace:
- Maximum amount of nodes per sibling group:

Navigation

- Expand on → (right arrow) key
- Collapse on ← (left arrow) key
- Expand/Collapse on spacebar
- Keep column position on ↑↓ (up/down arrow) key

Editing

- Change type of all selected cells simultaneously:
- Keep json value when changing type to object/array:
- Paste direction for inserted items:

Persistence

- Store formulas in document (if possible)

JSON Tables

- Detect tables automatically on loading
- Minimum amount of filled value cells: %

XML Tables

- Detect tables automatically on loading
- Minimum amount of filled value cells: %

Clipboard

- Default copy to clipboard for table value cells:

Display

The check boxes in the *Display* section are fairly self-explanatory. Given below are a few notes for clarification.

- If all cells are not expanded on loading, then the root node and all its descendants are collapsed. You will need to expand each node as you go deeper into the document.
- If *Convert XML entities to raw text on loading* is selected, then XML entities will be loaded in Grid View as the raw text of the respective entity; they will not be resolved to their respective glyph representations.
- If *Show inline previews* is not checked, then, instead of a preview of the cell being shown, only the index number of the element in the cell will be shown. If inline previews are enabled, then you can opt to show a preview that contains (i) both element content and attributes, or (ii) attributes only. To opt for the latter, check *For attributes only*; to opt for the former, uncheck *For attributes only*. Note that only the first part of the inline content of a cell will be shown; you can hover over an element's start tag to see all of its content.
- When optimal widths are switched on, the entire width of the grid is displayed. To achieve this, text in some cells will wrap.
- When text overflows a cell, the overflow can be shown either as text that fades or be indicated by an ellipsis.
- You can switch the display of whitespace in grid cells on or off. A space character is shown as a vertically centered dot and a tabs is displayed as an arrow. An end-of-line is indicated with a new linefeed inside the cell.
- Sibling nodes can be organized into sibling groups of 100, 1k, or 10k nodes (*see screenshot below*). This is useful for two reasons: (i) saving space in the display and aiding navigation; (ii) avoiding a delay in rendering that loading a large number of records would entail. At any time, one sibling group is shown expanded. This group can be collapsed only by expanding another group. If you do not want to group siblings, then select *Unlimited*.

9998	52579269	42.454218	1.4706366
9999	52579270	42.4542084	1.4707958
10000	52579271	42.4541842	1.4709068
▼ <> node <10001..20000>			
▼ <> node <20001..30000>			
▼ <> node <30001..40000>			
▼ <> node <40001..50000>			
▼ <> node <50001..60000>			
▼ <> node <60001..70000>			
▼ <> node <70001..74427>			
▼ <> way (2987)	<way id="6165450" version="12" timestamp="2011-05-17T16:00:08Z" cha		
▼ <> relation (79)	<relation id="7439" version="186" timestamp="2013-08-27T13:50:01Z" cha		

Groups of 10k nodes

Navigation

Basically, you can use the arrow keys to navigate the grid. These setting provide smart options for using the keys.

- *Expand on Right Arrow key*: If a cell item is collapsed, then pressing the *Right Arrow* key expands the item in the cell. If the cell item is not collapsed, the *Right Arrow* key takes you to the next cell on the right (including to the child if the next cell on the right is a child). If the option is not selected, the *Right Arrow* key stops at a collapsed cell. Note that the *Expand on Right Arrow key* feature does not apply to cells within tables; in table cells, the action takes you to the next cell on the right.
- *Collapse on Left Arrow key*: When you move left with the *Left Arrow* key, then, at some points, you

must also move up the document hierarchy. If this option is selected, then items that can be collapsed will be collapsed when the *Left Arrow* key is pressed; otherwise such items will not be collapsed although the focus will shift to the parent item. Note that the *Collapse on Left Arrow key* feature does not apply to cells within tables; in table cells, the action takes you to the next cell on the left.

- *Expand/Collapse on Spacebar*: The spacebar functions as a toggle to expand/collapse an item. It can therefore be used as an additional key for navigating the grid.
- *Keep Column Position on Up/Down Arrow keys*: The *Up* and *Down Arrow* keys take you, respectively, up and down through cells of the grid, including through parent and children items—which are hierarchically at different levels, and so in different columns. If this option is selected, levels that are represented in columns other than the current column are skipped. This works, for example, like this. Say the cursor is in the column for the element `subject/course/books/book/title`. With the *Keep Column Position* option selected, you can use the *Up* and *Down* arrow keys to navigate only through titles of books (without going into the `book`, `books`, `course`, or `subject` columns, or any columns for descendant items of `title`.)

Editing

The check boxes in the *Display* section are fairly self-explanatory. Given below are a few notes for clarification.

- When changing the type of multiple selected cells, you are given the following options about whether to go ahead with the action of the setting: *Always*, *Never*, or *Ask* (for user decision).
- When changing a JSON type to from an atomic type to object or array, you are given the following options about whether to go ahead with the action of the setting: (i) *Ask* (whether the value of the atomic type should be retained as the value of an unnamed child `key:value` pair, or discarded), (ii) *Always* (retain the value in an unnamed child `key:value` pair), (iii) *Never* (retain the value, that is, discard the value).
- The *Paste direction* option determines whether a selection in the clipboard is pasted above or below the selected cell.

Persistence

Formula expressions and formula results are always stored in the application metadata file for filters and formulas. However, if the *Persistence* option is selected, then formulas can also be saved in the document itself.

- In XML documents, formula expressions are stored as processing instructions and formula results are stored as element content.
- In JSON5 and JSONC documents, formula expressions are stored as comments and formula results are stored as JSON properties.

The *if possible* terminology of the option refers to the fact that comments are allowed only in JSON5 and JSONC documents—not in other JSON documents.

JSON Tables. XML Tables

If the setting to detect Grid View tables automatically on loading is selected, then you can select the minimum percentage of filled table cells that qualify tables to be detected as tables. If the number of filled table cells does not exceed this level, then the structure is displayed as a normal grid with the repeating elements listed one below the other.

Clipboard

You can also choose whether clipboard contents should be stored as tab-separated values (TSV), or as XML/JSON (depending on the document type). This is a very useful feature: If you want to paste a table from the clipboard to another document, this setting enables you to choose whether the copied table is stored as TSV or with markup. (To see the difference, try pasting a table to a text editor after copying the table to the clipboard in each of the formats.)

4.4 Schema View

Altova website: [XML Schema Editor](#)

XML Schemas can be viewed and edited graphically in Schema View (*screenshot below*). The graphical interface enables you to build schemas quickly and accurately using typical GUI features. Schema View has two panes: (i) an upper pane for designing the structural relationships between schema components; and (ii) a lower pane for definitions related to the component selected in the upper pane. There are also three entry helpers that greatly facilitate the creation of valid schemas: the Components, Details, and Facets entry helpers.

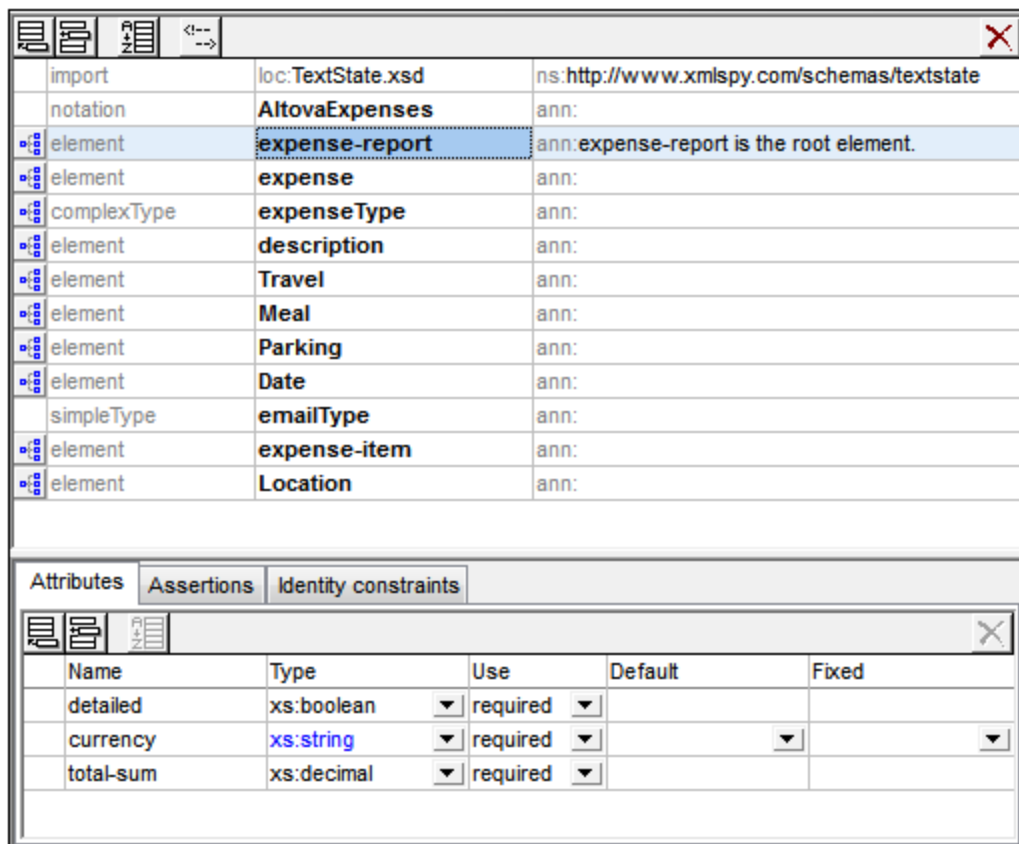

Upper pane: schema design

The upper pane of Schema View can be switched between two views:

- [Schema Overview](#)²⁰⁴ displays all global components of the schema (such as global elements and complex types) in a simple tabular list ([see screenshot](#)²⁰⁴). By clicking the icon of a global component you can switch to the Content Model View of that global component. Note that not all global components can have a content model (for example, simple types).
- [Content Model View](#)²¹⁶ displays the content model of the selected global component ([see screenshot](#)²¹⁶). To return to Schema Overview, click the Show Globals icon at the top left of the upper pane.



Switch to Content Model View: Available for global components that have a content model. Opens the global component's content model in [Content Model View](#)²¹⁶.



Show Globals: Available in Content Model View. Switches to [Schema Overview](#)²⁰⁴.

Lower pane: Attributes, Assertions, and Identity Constraints

The lower pane of Schema View ([see screenshot](#)²³⁷) contains tabs for the definitions of [Attributes](#), [Assertions](#), and [Identity Constraints](#)²³⁷ of the component selected in the design (upper pane). We call this pane the AAIDC pane for short.

- In XSD 1.0 mode, the lower pane has two tabs: (i) [Attributes](#)²³⁸, and (ii) [Identity Constraints](#)²⁴⁵.
- In XSD 1.1 mode, the lower pane has three tabs: (i) [Attributes](#)²³⁸, (ii) [Assertions](#)²⁴¹, and (iii) [Identity Constraints](#)²⁴⁵.

The AAIDC pane is always present in Schema Overview and may be present in Content Model View. In Content Model View, all three types of definitions (attributes, assertions, IDCs) can be displayed in the diagram instead of in the AAIDC pane. To do this, toggle the respective Schema Design toolbar buttons on: (i) **Display attributes in diagram**, (ii) **Display assertions in diagram**, and (iii) **Display identity constraints in diagram**. Alternatively, you can specify these preferences in the Schema Display Configuration dialog ([Schema Design | Configure View](#)⁸⁹³). When all the definition-types of the AAIDC pane are displayed in the diagram, the lower pane will no longer be visible in Content Model View.

Schema settings

The Schema Settings dialog ([Schema Design | Schema Settings](#)⁸⁸⁴) is accessed from Schema View and lets you define global settings for the active schema. These settings are the attributes of the `xs:schema` element.

Organization of this section

This section is organized into the following sub-sections

- [XSD Mode: XSD 1.0 or 1.1](#)²⁰⁰: Select between the two editing modes
- [Schema Overview](#)²⁰⁴: Edit the properties of global components
- [Content Model View](#)²¹⁶: Edit the content models of individual global components
- [Attributes, Assertions, and Identity Constraints](#)²³⁷: Define these particular properties of components
- [Entry Helpers](#)²⁵²: Use these to quickly define various properties of components
- [Smart Restrictions](#)²⁶⁷: Graphically create and edit derived types from base types
- [Using xml: prefixed attributes](#)²⁷²: Add the `base`, `id`, `lang`, and `space` attributes graphically to schema components
- [Back and Forward: Moving through Positions](#)²⁷³ explains a Schema View feature that enables you to move through previously viewed positions

Connecting to SchemaAgent

From XMLSpy you can also connect to SchemaAgent in order to display components from other schemas in the GUI and to use these components in the schema being currently edited. How to work with SchemaAgent in XMLSpy is described in the section [Working with SchemaAgent](#)³³⁷.

Find in schemas

The Find in Schemas features enables intelligent searches in schemas, i.e., searches that are restricted by various schema-related criteria. For example, searches may be restricted to certain component types, thus making the search more efficient. Find in Schemas is described in the [DTDs and XML Schemas section](#) ³⁴⁸.

4.4.1 XSD Mode: XSD 1.0 or 1.1

In Schema View you can select whether the XML Schema (XSD) should be edited and validated according to the XML Schema 1.0 specification (XSD 1.0) or the XML Schema 1.1 specification (XSD 1.1). The **XSD mode** that is used for editing a file is based on two settings: one in the application, the other in the XSD document.

Selecting XSD mode

The XSD mode determines the Schema View editing and validation features (XSD 1.0 or 1.1) available for the active document. You can either: (i) make an application-wide setting, in which case all XSD documents in Schema View will be edited in the selected mode, or (ii) you can save the XSD version number in the XSD document and let the application automatically select the XSD mode according to this information.

Application-wide mode

The application-wide setting is made in the File section of the Options dialog (**Tools | Options**, see *screenshot below*). If you select the *Version 1.0* or *Version 1.1* radio button, then the selected mode becomes the application-wide mode. All XML Schema documents opened in Schema View will now be edited in this mode. (If you select the *v1.1 if <xs:schema vc:minVersion="1.1" ... > v1.0 otherwise* setting, the mode will depend on information in the document and will not be application-wide. See *Document-specific mode* and the other sections below for information about this.)

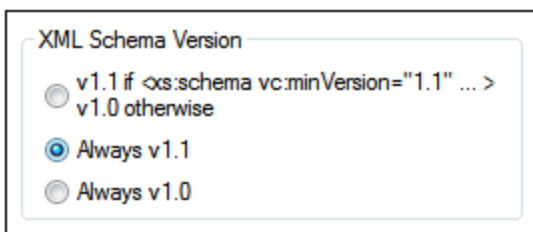

You can switch between the two application-wide modes (*Version 1.0* and *Version 1.1*) at any time by selecting the option you want in the XML Schema Version setting of the Options dialog (*screenshot above*).

Note: If the current setting is an application-wide setting and you switch modes using the **XSD 1.0** or **XSD 1.1** button in the Schema Design toolbar (see *next section*), then the mode switch because of the button will be temporary, and the mode will revert to the application-wide mode when the document is reloaded. A reload happens each time the view is changed or when Schema View is refreshed (via **File | Reload**).

Document-specific mode

You can also choose to save the XSD mode information in the XSD document itself. This would enable Schema View to automatically switch to the document's XSD mode when the document is loaded. You can add XSD

mode information to an XSD document by clicking the **XSD 1.0** or **XSD 1.1** button in the Schema Design toolbar (*screenshot below*). On doing this, the selected mode is saved in the `vc:minVersion` attribute of the top-level `xs:schema` element. (The value of the `vc:minVersion` can also be added manually in Text View.)



Note: The `vc:minVersion` attribute, if present, must be in the namespace <http://www.w3.org/2007/XMLSchema-versioning>. In this case, the XML Schema document must have a namespace declaration binding the `vc:` namespace prefix to this namespace. If you use the **XSD 1.1** toolbar button (*screenshot above*), the namespace is added automatically. Clicking the **XSD 1.0** toolbar button removes this namespace declaration if no other node name in the document is in this namespace.

To activate the document-specific mode and specify a document's XSD mode, do the following:

1. *Activate document-specific mode:* In the File section of the Options dialog (**Tools | Options**), set the XML Schema Version option to *v1.1 if <xs:schema vc:minVersion="1.1" ... > v1.0 otherwise* (see *screenshot below*). This indicates to XMLSpy that the XSD mode in Schema View should be set according to the `vc:minVersion` attribute of the `xs:schema` element.

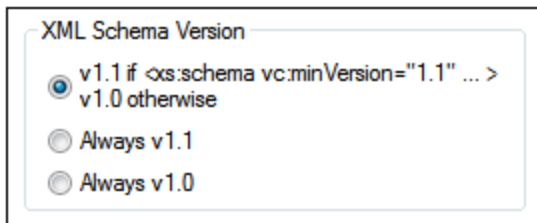

2. *Specify the document's XSD version:* In the Schema Design toolbar (*screenshot above*), click the **XSD 1.0** or **XSD 1.1** button. A confirmation dialog (*screenshot below*) pops up.

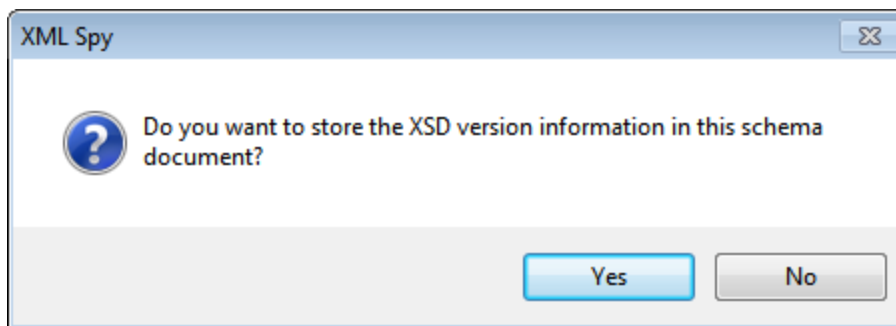

3. Clicking **Yes** results in the following: (i) enters the corresponding value in the `vc:minVersion` attribute of the `xs:schema` element, and (ii) if **XSD 1.1** was selected, declares the `XMLSchema-versioning` namespace with a binding to the `vc:` namespace prefix; if **XSD 1.0** was selected, the namespace declaration is removed if no other node is in the `XMLSchema-versioning` namespace. The XML Schema document now contains the XSD version number. On saving the file, the XSD mode information is saved with it. When you reopen or reload the file, Schema View will automatically switch to the document's XSD mode as contained in the `vc:minVersion` attribute of the `xs:schema` element.

Note: If the document-specific mode option is selected, and if the XSD document has no `vc:minVersion` attribute or the value of the `vc:minVersion` attribute is other than 1.0 or 1.1, then Schema View defaults to XSD 1.0 mode.

Note: Do not confuse the `vc:minVersion` attribute with the `xsd:version` attribute. The former holds the XSD version number, while the latter hold the document version number.

XSD mode of new documents

When you create a new XSD document you will be prompted about whether you wish to create it as an XSD 1.0 or XSD 1.1 document. If XSD 1.1 is selected, the new document is created with the attribute `/xs:schema/@vc:minVersion="1.1"` and the `XMLSchema-versioning` namespace with a binding to the `vc:` namespace prefix is declared. If XSD 1.0 is selected, then neither the `vc:minVersion` attribute nor the `XMLSchema-versioning` namespace declaration is added. However, which XSD mode is actually enabled in Schema View depends also on the XML Schema Version selected in the File section of the Options dialog (**Tools | Options**). See the next section for details about how these two settings interact.

The enabled XSD mode

The XSD mode that is enabled in Schema View depends on both (i) the presence/absence—and, if present, the value—of the `/xs:schema/@vc:minVersion` attribute of the XSD document, and (ii) the XML Schema Version option selected in the File section of the Options dialog (**Tools | Options**, *screenshot below*).

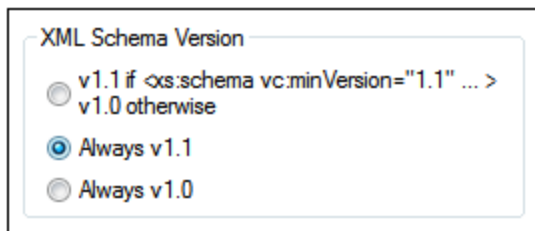

The following situations are possible. *XML Schema Version* in the table below refers to the selection in the XML Schema Version pane shown above. The `vc:minVersion` values in the table below refer to the value of the `xs:schema/@vc:minVersion` attribute in the XML Schema document.

XML Schema Version	<code>vc:minVersion</code> attribute	XSD mode
<i>Always v1.0</i>	Is absent, or is present with any value	1.0
<i>Always v1.1</i>	Is absent, or is present with any value	1.1
<i>Value of @vc:minVersion</i>	Attribute has value of 1.1	1.1
<i>Value of @vc:minVersion</i>	Attribute is absent, or attribute is present with a value other than 1.1	1.0

Note: In the situations described in the first two rows, it is possible that an XSD 1.1 schema is opened in XSD 1.0 mode and vice versa. The inconsistencies will be handled as described further below.

XSD mode features

The interface and editing features of Schema View will change according to which XSD mode (XSD 1.0 or XSD 1.1) is enabled.

If **XSD 1.0 mode** is enabled:

- Editing support for new XML Schema 1.1 components and properties is not available. However, if XSD 1.1 components or properties are already present in the XSD document, these will be displayed and will be available for deletion.
- Validation is performed against the XSD 1.0 specification. So, if an exclusively XSD 1.1 component or property (already) exists in the schema, a validation error is reported.

If **XSD 1.1 mode** is enabled, editing support is provided for all features of XML Schema 1.1. Validation is with respect to the XML Schema 1.1 specification.

Handling of XSD 1.1 features in XSD 1.0 mode

If an XSD 1.1 feature that is not supported in XSD 1.0 is present in the document (for example, an assertion), how such a feature is displayed and handled in XSD 1.0 mode is described below.

- **Assertions:** If at least one assertion is present on the selected simple type, the *Assertions* tab is present in the Facets entry helper. No editing is possible except for deletion of the assertion.
- **Asserts:** The assertion is displayed in the diagram of the complex type if present. No *Assertions* tab is available in the AAIDC pane. Assertion cannot be added via context menu. No editing of properties is possible except for deletion.
- **Attributes:** New property `inheritable` is displayed if present. No editing is possible except for selecting the empty value (this is effectively a removal of properties).
- **Complex types:** The new property `defaultAttributesApply`, if present, is displayed in the Details entry helper. No editing is possible except for selecting the empty value (this is effectively a removal of properties).
- **Documentation:** New XSD 1.1-specific components and properties are not included in Schema View documentation.
- **Facets:** Unknown facets cause validation errors and are displayed in red.
- **Find in schemas:** New XSD 1.1-specific components and properties are ignored.
- **Identity constraints (IDCs):** The property `isRef` is displayed in case of reference and can be switched off. It will be switched off as soon as the IDC's name is modified.
- **Multiple substitution groups:** Combo box to select single substitution group (only single substitution groups allowed in XSD 1.0).
- **Open content:** Displayed in diagram if present. Cannot be added via context menu. No editing is possible except for deletion. Default Open Content is not displayed within complex types.
- **Override:** Displayed in globals grid if present. Cannot be added via menu. No editing (of location) is possible except for deletion. Overriding components (that is, children of `xs:override`) are ignored and will not be included in the Components entry helper.
- **Schema settings:** New properties `defaultAttributes` and `xpathDefaultNamespace` are displayed in dialog if present. No editing is possible except for selecting the empty value (this is effectively a removal of properties).
- **Simple types:** Unknown types cause validation errors and are displayed in red.
- **Type Alternatives:** Displayed in diagram if present. Cannot be added via context menu. No editing (of properties) is possible except for deletion.
- **Wildcards:** New properties displayed if present. No editing is possible except for the selection of empty value (effectively a removal of properties).

4.4.2 Schema Overview

Schema Overview (*screenshot below*) displays a list of all the global components of the schema (`import` elements, global elements, complex types, etc).

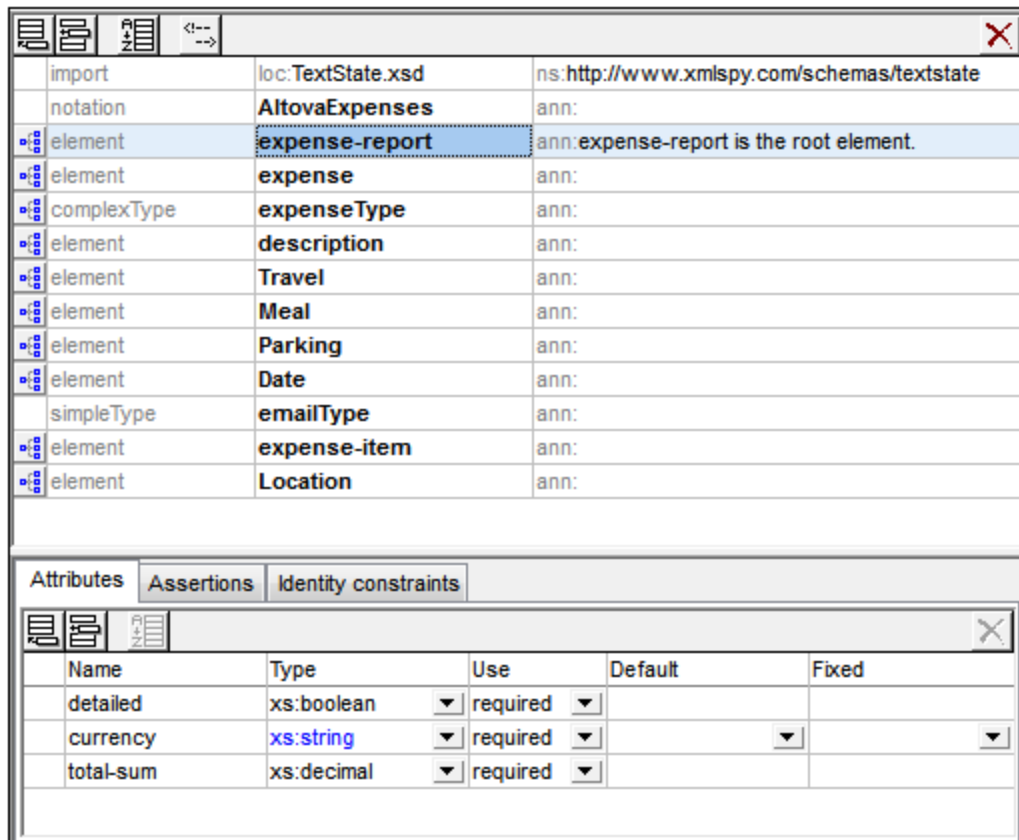

Name	Type	Use	Default	Fixed
detailed	xs:boolean	required		
currency	xs:string	required		
total-sum	xs:decimal	required		

You can insert, append, or delete global components, as well as modify their properties. To modify properties, select the global component in the Schema Overview list. Depending on what kind of global component it is, its properties can be edited in the [Details entry helper](#)²⁵⁶, the [Facets entry helper](#)²⁵⁸, and/or the [Attributes/Assertions/Identity Constraints \(AAIDC\) pane](#)²³⁷.

A global component that can have a content model has a **Switch to Content Model View** icon to its left in the global components list. Clicking this icon switches to the [Content Model View](#)²¹⁶ of that component, where the content model of that component can be edited.



Switch to Content Model View: Available for global components that have a content model. Opens the global component's content model in [Content Model View](#)²¹⁶.



Show Globals: Available in Content Model View. Switches to [Schema Overview](#)²⁰⁴.

In this section, we first describe the [GUI mechanisms](#)²⁰⁵ of Schema Overview, then describe the particulars of the various [global components](#)²⁰⁸.

4.4.2.1 GUI Mechanisms

Global components are added as children of the top level `xs:schema` element. Add a global component by clicking the **Append** icon or **Insert** icon at the top left of the upper pane (see *list of icons further below*), and then selecting, from the global components menu (*screenshots below*), the global component you want to add.

The screenshots below show the global components that can be added: XSD 1.1 mode on the left, XSD 1.0 mode on the right. (*Override* and *Default Open Content* are XSD 1.1 features.)

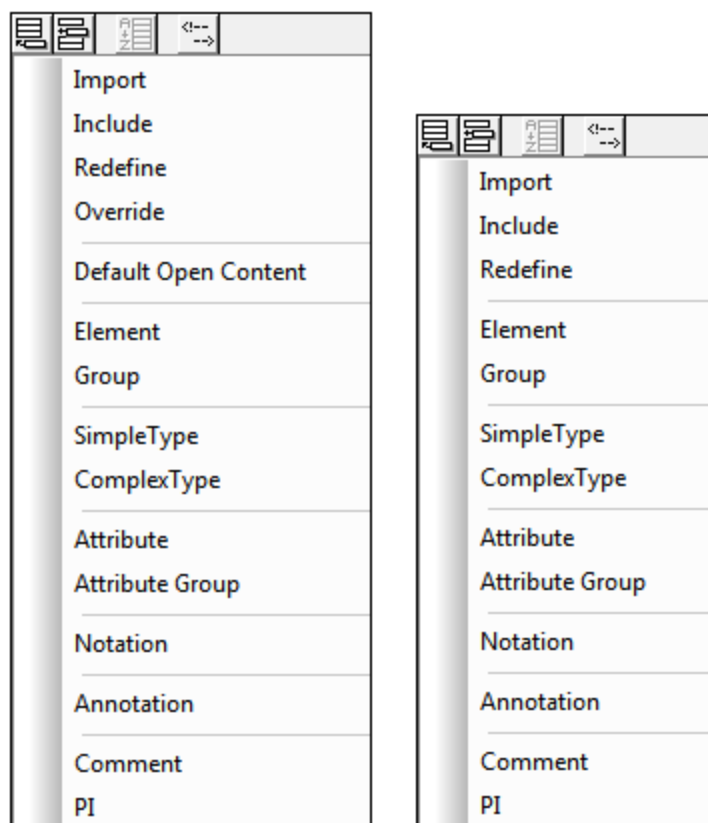

You can add as many global components as you like. All the global components in the schema are displayed in a tabular list in Schema Overview (*screenshot below*).





	loc:TextState.xsd	ns: http://www.xmlspy.com/schemas/textstate
import	loc:TextState.xsd	ns: http://www.xmlspy.com/schemas/textstate
notation	AltovaExpenses	ann:
element	expense-report	ann:expense-report is the root element.
element	expense	ann:
complexType	expenseType	ann:
element	description	ann:
element	Travel	ann:
element	Meal	ann:
element	Parking	ann:
element	Date	ann:
simpleType	emailType	ann:
element	expense-item	ann:
element	Location	ann:

Editing in Schema Overview

Note the following editing features of Schema Overview:

- You can reposition components in the Schema Overview list using drag-and-drop.
- You can navigate using the arrow keys and **Tab** key of your keyboard.
- You can use cut/copy-and-paste to copy or move global components, attributes, assertions, and identity constraints from one diagram to a different position in the diagram, to other diagrams, and from one schema to another.
- Right-clicking a component opens a context menu that allows you to cut, copy, paste, delete, or edit the annotation data of that component.
- To enter a new line in global comments and global annotations, press **Ctrl+Enter**. To enter a tab, press **Ctrl+Tab**.

Schema Overview and related icons

	<i>Append Global Component:</i> Adds global components to the bottom of the global components list. If the component must, by definition, occur at the beginning of the document, it is added to the top of the list.
	<i>Insert Global Component:</i> Adds global components above the selected component. If the component must, by definition, occur at the beginning of the document, it is added to the top of the list.
	<i>Sort:</i> Pops up the Sort Components dialog, in which the precedence of sort criteria can be set (name before kind, or vice versa), before going ahead with the sorting. <i>See description below.</i>
	<i>Comments:</i> Pops up a menu to select between multi-line and single-line display of global comments. <i>See description below.</i>
	<i>Switch to Content Model View:</i> Available for global components that have a content model. Opens the global component's content model in Content Model View ²¹⁶ .



Show Globals: Available in Content Model View. Switches to [Schema Overview](#)²⁰⁴.

Switching between Schema Overview and Content Model View

Some global components (such as complex types, element declarations, and model groups) have a **Switch to Content Model View** icon to the left of the component name (see *list of icons above*). This indicates that these global components can have a content model which describes the component's structure and contents.

Clicking this icon switches the view from Schema Overview to the [Content Model View](#)²¹⁶ of that global component. Other global components (such as annotations, simple types, and attribute groups) do not have a content model, and therefore do not have the **Switch to Content Model View** icon. You can switch back to Schema Overview from Content Model View by clicking the **Show Globals** icon (see *list of icons above*).

Sorting global components

You can sort global components by clicking the **Sort** icon in the Schema Overview toolbar (see *list of icons above*). In the Sort Components dialog that pops up (*screenshot below*), you can choose to sort either all sortable global components, or the set of selected components. You can use **Shift**+click to select a range and **Ctrl**+click to add additional components to the selection.

Note: Global components that must occur at the start of the document (such as `include` and `import`) are not affected by the sorting feature. They are not part of the range of global components that may be sorted.

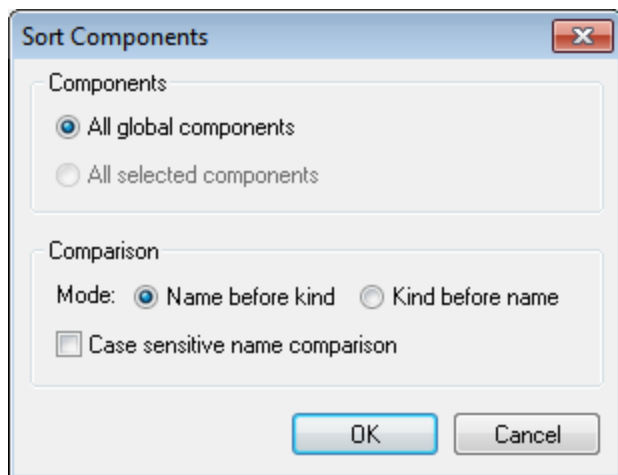

After setting the range you can choose to sort the sortable range alphabetically (*Name before kind*), or organized first by kind and then by name.

The sort order is implemented in the text of the schema.

Global comments: line display mode

Global comments can be displayed in a multi-line text field (default) or a single-line text field (see *screenshots below*).

element	Desc
comment	This is the first line of this comment. This is the second line. This is the third line.
element	para

element	Desc
comment	This is the first line of this comment.
element	para

To switch between these two display modes of comments, click the **Comments** icon at the top of the Schema Overview pane and select the option you want. Within the text of a comment, if you wish to create a new line (and so make the comment a multi-line comment), press **Ctrl+Enter**. When comments are in single-line text-field display mode, placing the cursor over a multi-line comment pops up a multi-line box that displays all the lines.

4.4.2.2 Global Components

Global components are those that are added as children of the top-level `xs:schema` element (as opposed to local components, which are created within other components). Some global components, such as complex types, elements and attributes can be referenced by other components in the schema.

Creating global components in Schema Overview

Global components are typically created and edited in [Schema Overview](#)²⁰⁴. In Schema Overview, they are added via the [Append](#)²⁰⁵ or [Insert](#)²⁰⁵ icons²⁰⁵. The content model of a global component (if the global component can have one, see table below) is created and edited in the [Content Model View](#)²¹⁶ of that global component. (Click the **Switch to Content Model View** icon to the left of a component's name to go to [Content Model View](#)²¹⁶.)

Some global components, on being created in Schema Overview, are also added to the [Components entry helper](#)²⁵². If a component has a content model, double-clicking its name in the Components entry helper will open the content model for editing in [Content Model View](#)²¹⁶.

If the global component has a type definition (simple type or complex type), then clicking the component's context menu command **Go to Type Definition** will take you to the type definition. In the case of built-in simple types, a message box appears that contains information about the simple type.

Note: You can also create some global components (elements, attributes, simple types, complex types, and model groups) while editing in Content Model View. Right-click anywhere in the window and select **New Global | < Type of Global Component >**.

Note: While editing in Content Model View, you can make a local element a global element—or a global complex type if the element has an element or attribute child. Select the local element, right-click anywhere in the window, and select **Make Global | Element** or **Make Global | Complex type**.

Global component	Location in Schema	Content Model
------------------	--------------------	---------------

include	Beginning	No
import	Beginning	No
redefine	Beginning	No
override ^{1.1}	Beginning	No
defaultOpenContent ^{1.1}	After Includes, Imports, Redefines Overrides; before any other	Yes
element	Anywhere after defOpenCont	Yes
group	Anywhere after defOpenCont	Yes
simpleType	Anywhere after defOpenCont	No
complexType	Anywhere after defOpenCont	Yes
attribute	Anywhere after defOpenCont	No
attributeGroup	Anywhere after defOpenCont	No
notation	Anywhere after defOpenCont	No
annotation	Anywhere after defOpenCont	No
<i>Comment</i>	Anywhere	No
<i>Processing instruction</i>	Anywhere	No

Given below are key points about editing these components in Schema View.

Includes, Imports, Redefines, and Overrides

These four global components allow other schema documents to be reused within the current schema document.

- Includes reuse documents that have the same target namespace as that of the current document.
- Imports reuse documents that have other target namespaces as that of the current document.
- Redefines and Overrides are types of Includes in that they have the same target namespace as the current document. They, however, modify parts of the included schemas. Redefines are a 1.0 feature and are deprecated in 1.1. Overrides, which are a 1.1 feature, are more flexible and have been designed to replace Redefines in 1.1.

All four have a `schemaLocation` attribute that points to the schema to be reused. In Schema View, when you double-click in the `loc` field of these components, you can browse for the file to reuse and set its path relative to the current document. The `import` component additionally has a `namespace` attribute that holds the target namespace of the imported schema.

When a schema is reused in the current schema document (via includes, imports, redefines, or overrides), its global components, namespaces, and identity constraints are displayed in the [Components entry helper](#)²⁵² of the current document.

Redefines

In a `redefine` component, you can modify complex types, simple types, model groups and attribute groups. The component to be redefined will be in the schema specified in the `loc` field of the `redefine` component (in the screenshot below the components to be redefined are in the schema `ExpReport.xsd`). After a `redefine` component is added, you must add the component to be redefined into a position between the `redefine` and `end of redefine` rows of the global components list (see screenshot below, where the components `New` and `emailType` are redefined). These two components exist in the schema `ExpReport.xsd` and are being redefined for the current schema.

Component	Location	Namespace
import	loc:address.xsd	ns:http://www.altova.com/IPO
import	loc:TextState.xsd	ns:http://www.xmlspy.com/schemas/textstate
redefine	loc:ExpReport.xsd	
attributeGroup	New	ann:
simpleType	emailType	ann:
end of redefine		
notation	Altova-Orgchart	ann:

To redefine a component, do the following:

1. Select the `end of redefine` row.
2. Click the **Insert** icon in the top left of Schema Overview.
3. Select the kind of component you wish to define (complex type, simple type, model group or attribute group). The component is added within the `redefine` component.
4. Give it the same name as the component you wish to redefine. The component will now have all the properties of the component from the schema that is being reused.
5. Redefine the component by selecting it and modifying its properties in the Details and Facets entry helpers, or by modifying its content model in Content Model View (if it has a content model).

Note: You might also be able to insert the components to be redefined as follows: either from elsewhere in the global components list or from the Components entry helper, using drag-and-drop or copy-paste.

Redefined components can be referenced by other components in the schema.

Overrides

In an `override` element you can define the following components: complex types, simple types, global elements, global attributes, model groups, attribute groups, and notations. If, within an `override` element, one of these components is defined, then this component will replace, in the overridden schema, all components of the same kind that have the same name as the overriding component. The overridden schema is specified in the `loc` field of the `Override`.

Overrides differ from Redefines (see above) in that they are components defined from scratch and not based on any reused component. In Schema View, you add components for overriding similarly to how you add components for redefining. Insert the overriding component above the `end of override` row and then define its properties. See the 'Redefine' section above. The main difference between an `Override` and a `Redefine` is that when a component is added to an `Override`, it is not based on any component from the reused schema.

Default open content

The `defaultOpenContent` element is new in XSD 1.1 and specifies that one or more undefined elements can be added to any complex type of mixed or element-only content. It is similar to the `openContent` ²³⁴ element (also new to XSD 1.1), the main difference being that while the `openContent` element applies to a single complex type, the `defaultOpenContent` element applies to all complex types in the schema.

The `defaultOpenContent` element occurs once in the document (see screenshot below), after Includes, Imports, Redefines, and Overrides, and before the definitions of components. It has a `mode` attribute which can take a value of either `interleave` or `suffix`. The default is `interleave`.

import	loc:address.xsd	ns:http://www.altova.com/IPO
import	loc:TextState.xsd	ns:http://www.xmlspy.com/schemas/textst:
defaultOpenContent	suffix	ann:
notation	Altova-Orgchart	ann:
complexType	DivisionType	ann:
element	OrgChart	ann:

The `defaultOpenContent` element has a content model that you can edit in Content Model View. Once declared, the `defaultOpenContent` element will apply to all complex types in the schema. In the screenshot below, you can see that the `defaultOpenContent` has been applied automatically to the `OfficeType` and `Desc` complex types.

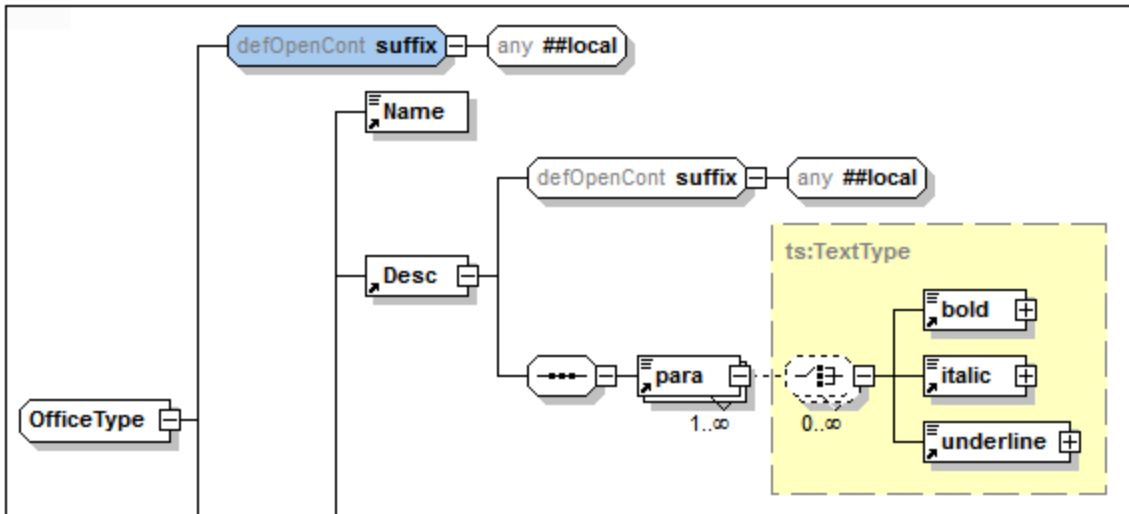

To override the `defaultOpenContent` element when it is applied to a particular complex type, add a child `openContent` element to that complex type. In the screenshot below, the `Desc` element with the `defaultOpenContent` element (see screenshot above) has had an `openContent` element added to it that overrides the `defaultOpenContent` element.

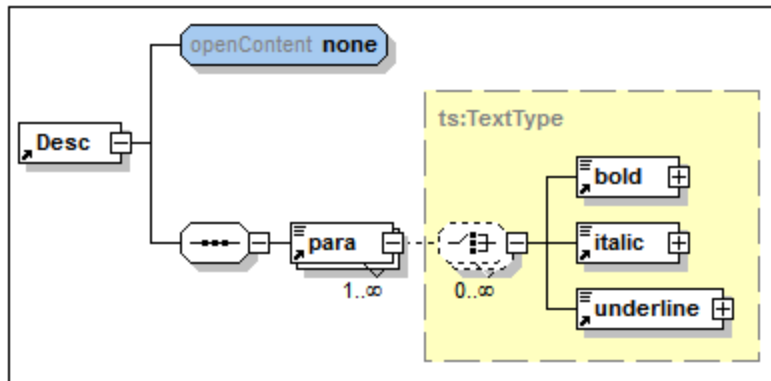

Global elements (element)

In Schema Overview, you can create a global element. If the global element is to have a content model, then this is defined in the Content Model View of the global element. With the element selected in either view, you can define [attributes](#)²³⁸, [assertions](#)²⁴¹, and [identity constraints](#)²⁴⁵ in the respective tabs of the [AAIDC pane](#)²³⁷. Facets and other properties can be defined in the element's [Facets](#)²⁵⁸ and [Details](#)²⁵⁶ entry helpers. Global elements can then be referenced by complex types.

Model groups (group)

In Schema Overview, you can create named model groups that can then be referenced in complex types. A named model group (the `xs:group` element) allows you to predefine a content model that can be reused. It can contain one of three kinds of child model group: a `sequence` group, a `choice` group, or an `all` group.

You create a named model group in Schema Overview by adding a Group component, giving it a name, and then defining its content model in Content Model View. The named model group can then be added to the content model of a complex type.

Named simple types (simpleType)

In Schema Overview you can create named simple types (*see screenshot below*), which can then be referenced in element and attribute declarations.

In the Details entry helper you specify the content of the simple type (`restriction`, `list`, `union`) and the corresponding type: respectively, the base type, item type, and member type. In the screenshot below, for example, the base type of the simple type's restriction is `xs:integer`. See the [Details entry helper section](#)²⁵⁶ for more information. To restrict a simple type with facets, use the options in the [Facets entry helper](#)²⁵⁸.

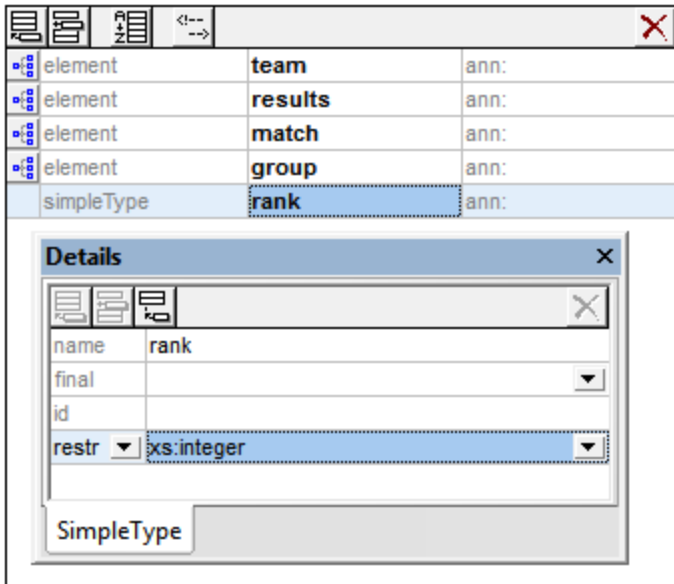

Note: Anonymous types can be declared on an element or attribute of simple content in either [Schema Overview](#)²⁰⁴ or [Content Model View](#)²¹⁶. When you set the `derivedBy` property (in the Details entry helper) to `restriction`, `list` or `union`, you create an anonymous simple type within that element or attribute declaration. You can define restriction facets (in the Facets entry helper) and other properties in the Details entry helper.

Named complex types (complexType)

In Schema Overview you can create named complex types, which can then be referenced in element declarations. With the named complex type selected in either view, you can define its [attributes](#)²³⁸ and [assertions](#)²⁴¹ in the respective tabs of the [AIDC pane](#)²³⁷.

A complex type can have four types of content (*see list below*). You specify the various types of content in the Details entry helper as described below and, if desired (and allowed), a content model in [Content Model View](#)²¹⁶.

- *Simple content:* Set the base type of the simple content (*see screenshot below*). The `mixed` attribute (for mixed content) must have a value of `false` (the default value); this is why `true` in the screenshot below is displayed in red. No content model is allowed.

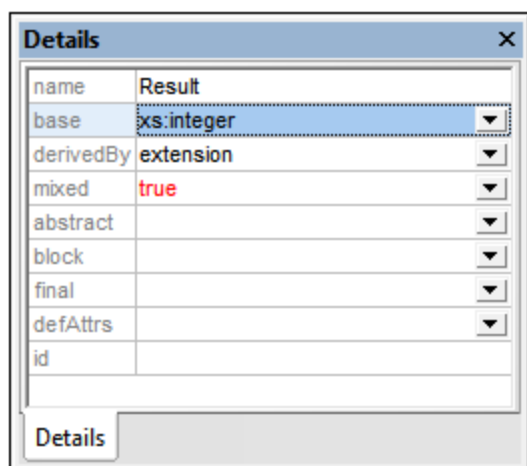

- *Element-only content*: Create child elements in the content model diagram. There will be no base type.
- *Mixed content*: The `mixed` attribute must be set to `true`. Character data can be present anywhere in the element among child element nodes. The character data does not have any datatype, so there must be no base type (see screenshot above). Child elements can be created in the content model diagram.
- *Empty content*: The element will have neither character data nor child elements. There must be no base type and `mixed` must be false. Data in empty-content elements is typically stored in attributes.

Note: Attributes and assertions can be set (in the [AAIDC pane](#))²³⁷ on all four types of content.

Note: Anonymous complex types are created within an element by creating a content model for that element in [Content Model View](#)²¹⁶.

Global attributes and attribute groups (attribute, attributeGroup)

Global attributes and attribute groups are added in Schema Overview.

- Properties of a **global attribute** are defined in the attribute's Details entry helper.
- After creating a **global attribute group**, you can add attributes to the group as follows: (i) Select the global attribute group in the global components list; (ii) Add attributes in the Attributes tab of the [AAIDC pane](#)²³⁷; and (iii) Define the properties of each attribute in the Details entry helper of the selected attribute.

After global attributes and attribute groups have been created, they can be referenced in the declarations of elements and complex types.

Notations (notation)

Notations are always global; there are no local notations. The properties of a notation are specified in the Details entry helper of the notation. The notation's name can be specified directly in the global components list. All notations in the schema are displayed in the Components entry helper for ease of reference.

Global annotations

Global annotations are global components and are not the same as the optional annotations that are available for some global components. You can edit a global annotation in the Annotation dialog (*screenshot below*), which is accessed by right-clicking the Annotation global component and selecting **Whole Annotation Data**.

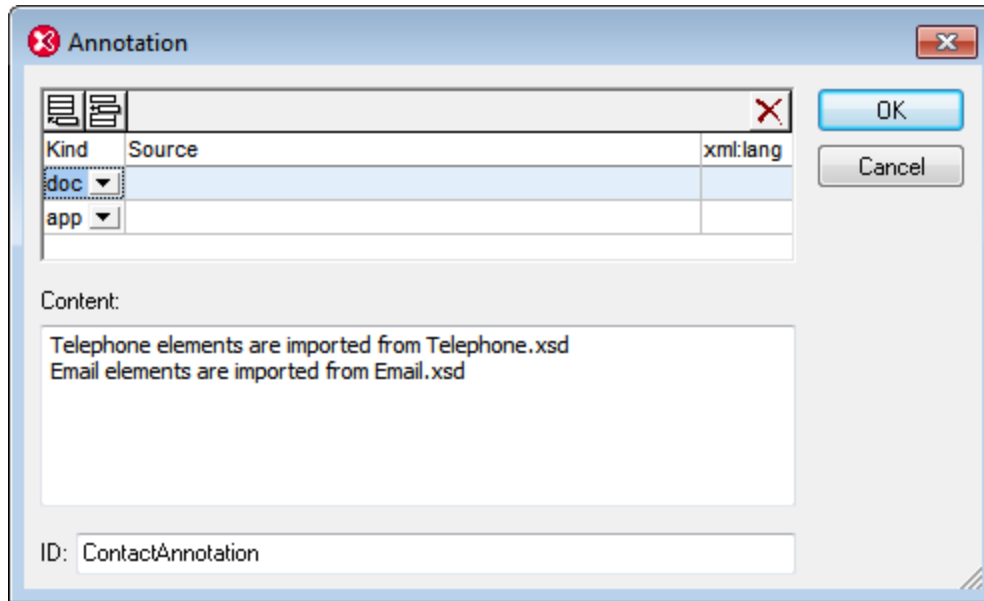

Each annotation can have an `id` attribute and multiple child `documentation` and/or `appinfo` elements. You can add `documentation` or `appinfo` elements by clicking the **Append** or **Insert** buttons at the top left of the dialog and then selecting the `doc` or `app` item from the respective combo boxes. Select a `doc` or `app` item in the top pane of the dialog and enter its content in the *Content* pane. If you wish to create a new line in the content (and so make the content multi-line content), press **Enter**. In the screenshot above, the `documentation` element is selected and can be seen to have two-line content. For each `documentation` or `appinfo` element, you can also enter optional `source` and `xml:lang` attributes.

In Schema Overview, only the first `documentation` or `appinfo` element of the global annotation is displayed and can be edited directly in the global components list. If that content is multi-line, placing the cursor over it reveals all the lines in a multi-line popup box. To display or edit the contents of the other `documentation` and/or `appinfo` elements, go to the Annotation dialog of that global annotation.

	element	Date	ann: Dates are in US format
	element	Location	ann:
	annotation	Addresses will come from the EuroCust database.	

Note: The optional annotations that are available for some global components can also be edited via the Annotation dialog in exactly the same way as for global annotations as described above.

Comments and processing instructions

Comments and processing instructions can be inserted anywhere in the global components list in Schema Overview. They cannot be added in Content Model View. If one or more comments or processing instructions



are present within simple types or complex types, they are collected and moved to the end of the enclosing object. It is therefore recommended that you use annotations instead of comments in such cases.

4.4.3 Content Model View

A content model is a description of the structure and content of a component. The following components can have content models:

- Complex types
- Elements
- Model groups
- Default open content

They are indicated in the global components list in [Schema Overview](#)²⁰⁴ with a **Switch to Content Model View** icon to the left of the component name.

	<i>Switch to Content Model View</i> : Available for global components that have a content model. Opens the global component's content model in Content Model View ²¹⁶ .
	<i>Show Globals</i> : Available in Content Model View. Switches to Schema Overview ²⁰⁴ .

Clicking on the **Switch to Content Model View** icon opens the Content Model View for that global component (see *screenshot below*). Alternatively, in [Schema Overview](#)²⁰⁴: (i) select a component and then select the menu option **Schema Design | Display Diagram**, or (ii) double-click on a component's name in the [Components entry helper](#)²⁵². Note that only one content model in the schema can be open at a time. When a content model is open, you can jump to the content model of a component within the current content model by holding down **Ctrl** and double-clicking the required component.

General description of Content Model View

The content model is displayed in the Content Model View as a tree (see *screenshot below*). You can configure the appearance of the tree in the Schema Display Configuration dialog (menu item [Schema Design | Configure view](#)⁸⁹³).

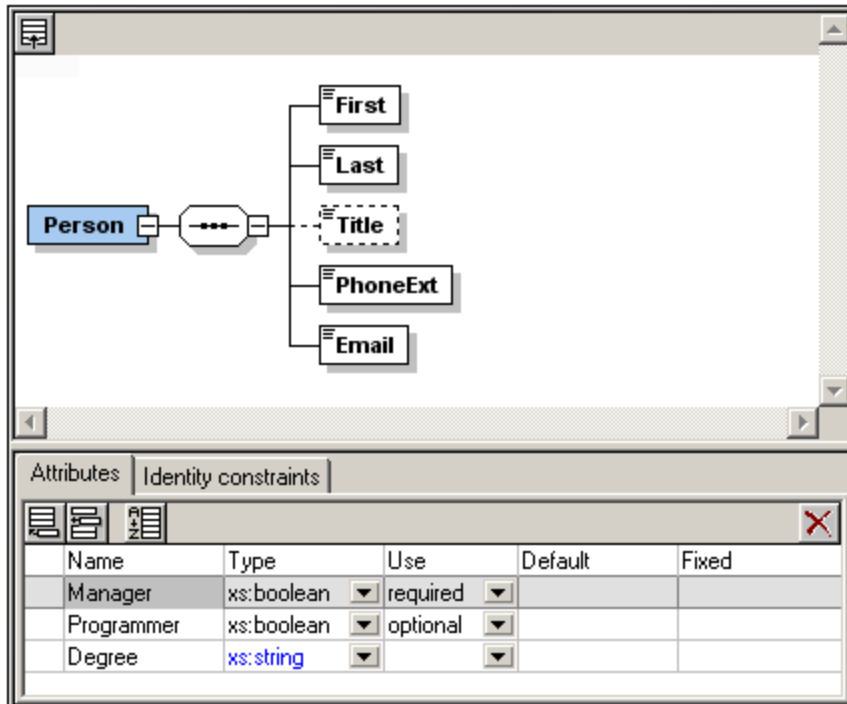

Note the following:

- Objects in the content model tree are of two types: compositors and components. Additionally, attributes, assertions, identity constraints, and open content can be shown in boxes attached to the component.
- Each level in the tree is joined to adjacent levels with a compositor. The content model can extend an unlimited number of layers deep.
- An object can be added relative to another object via the latter's context menu (accessed by right-clicking the latter object).
- Components in the content model can be local components or can reference global components.
- Drag-and-drop functionality enables objects to be moved around.
- Keyboard shortcuts can be used to copy (**Ctrl+C**) and paste (**Ctrl+V**) objects.
- The properties of an object can be edited in the Details entry helper and in the [AAIDC pane](#)²³⁷.
- The attributes, assertions, and identity constraints of a component are displayed in a pane below Content Model View, the [AAIDC pane](#)²³⁷. Attributes and identity constraints can also be displayed in the Content Model diagram instead of in the [AAIDC pane](#)²³⁷. This viewing option can be set in the [Schema Display Configuration dialog](#)⁸⁹³. Alternatively, you can use the three **Display in Diagram** buttons of the Schema Design toolbar (*screenshot below*).



- Sibling components can be sorted by selecting them, right-clicking, and selecting the **Sort Components** command from the context menu. You can prioritize by one of two sort criteria: (i) local name, and (ii) component kind.

These features are explained in detail in the subsections of this section and in the tutorial.

To return to [Schema Overview](#)²⁰⁴, click the **Show Globals** icon or select the menu option **Schema design | Display All Globals**.

4.4.3.1 Content Model Objects

In Content Model View, the objects shown in the diagram are best organized in three broad groups:

- [Compositors](#)²¹⁸: (i) sequence, (ii) choice, (iii) all
- [Components](#)²¹⁹: (i) element, (ii) complex type, (iii) model group, (iv) wildcard
- [Miscellaneous](#)²²²: (i) attribute, (ii) attribute group, (iii) assertion, (iv) constraint, (v) open content

The graphical representations of these objects are described individually below.

Compositors

A **compositor** defines the order in which child elements occur. There are three compositors: *sequence*, *choice*, and *all*.

To insert a compositor:

1. Right-click the element to which you wish to add child elements
2. Select **Add Child | Sequence** (or **Choice** or **All**).

The compositor is added, and will look as below:

- Sequence

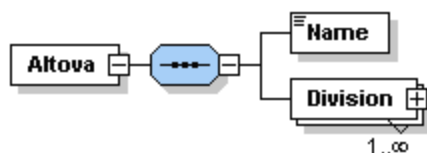

- Choice

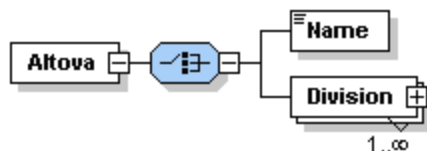

- All

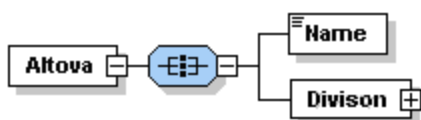

To change the compositor, right-click the compositor and select **Change Model | Sequence** (or **Choice** or **All**). After you have added the compositor, you will need to add child element/s or a model group.

Components

Given below is a list of components that are used in content models. The graphical representation of each provides detailed information about the component's type and structural properties.

- Mandatory single element



Details: The rectangle indicates an element and the solid border indicates that the element is required. The absence of a number range indicates a single element (i.e. `minOcc=1` and `maxOcc=1`). The name of the element is `Country`. The blue color indicates that the element is currently selected; (a component is selected by clicking it). When a component is not selected, it is white.

- Single optional element

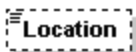

Details: The rectangle indicates an element and the dashed border means the element is optional. The absence of a number range indicates a single element (i.e. `minOcc=0` and `maxOcc=1`). Element name is `Location`.

Note: The context menu option **Optional** converts a mandatory element into an optional one.

- Mandatory multiple element



Details: The rectangle indicates an element and the solid border indicates that the element is required. The number range `1..5` means that `minOcc=1` and `maxOcc=5`. Element name is `Alias`.

- Mandatory multiple element containing child elements

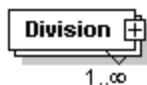

Details: The rectangle indicates an element and the solid border indicates that the element is required. The number range `1..infinity` means that `minOcc=1` and `maxOcc=unbounded`. The plus sign means complex content (i.e. at least one element or attribute child). Element name is `Division`.

Note: The context menu option **Unbounded** changes `maxOcc` to `unbounded`.

Clicking on the + sign of the element expands the tree view and shows the child elements.

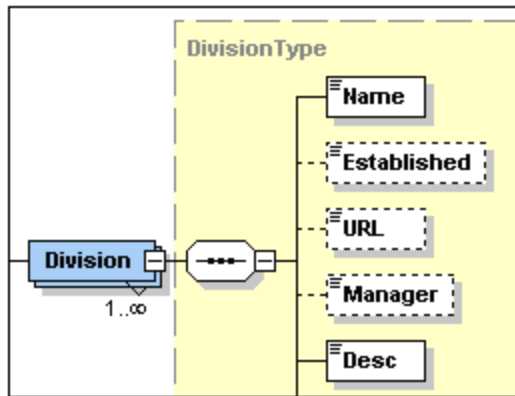

- Element referencing global element

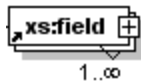

Details: The arrow in the bottom-left means the element references a global element. The rectangle indicates an element and the solid border indicates that the element is required. The number range 1..infinity means that `minOcc=1` and `maxOcc=unbounded`. The plus sign indicates complex content (i.e. at least one element or attribute child). Element name is `xs:field`.

Note: A global element can be referenced from within simple and complex type definitions, thus enabling you to re-use a global declaration at multiple locations in your schema. You can create a reference to a global element in two ways: (i) by entering a name for the local element that is the same as that of the global element; and (ii) by right-clicking the local element and selecting the option **Reference** from the context menu. You can view the definition of a global element by holding down **Ctrl** and double-clicking the element. Alternatively, right-click, and select **Go to Definition**. If you create a reference to an element that does not exist, the element name appears in red as a warning that there is no definition to refer to.

- Complex type

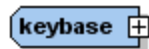

Details: The irregular hexagon with a plus sign indicates a complex type. The complex type shown here has the name `keybase`. This symbol (the irregular hexagon with a plus sign) indicates a global complex type. A global complex type is declared in the Schema Overview, and its content model is typically defined in Content Model View. A global complex type can be used either as (i) the data type of an element, or (ii) the base type of another complex type by assigning it to the element or complex type, respectively, in the Details entry helper (in either Content Model View or in Schema Overview).

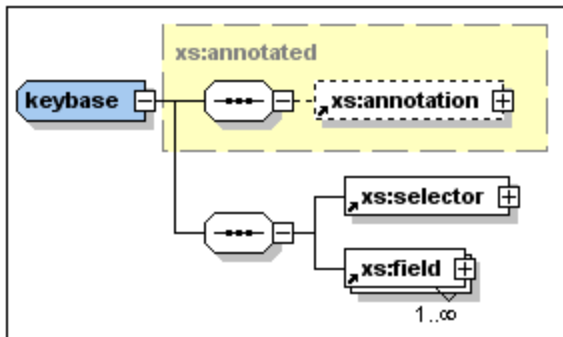

The `keybase` complex type shown above was declared in Schema Overview with a base type of `xs:annotated`. The base type is displayed as a rectangle with a dashed gray border and a yellow background color. Then, in Content Model View, the child elements `xs:selector` and `xs:field` were created. (Note the tiny arrows in the bottom left corner of the `xs:selector` and `xs:field` rectangles. These indicate that both elements reference global elements of those names.)

A local complex type is defined directly in Content Model View by creating a child element or attribute for an element. There is no separate symbol for local complex types.

Note: The base type of a content model is displayed as a rectangle with a dashed gray border and a yellow background color. You can go to the content model of the base type by double-clicking its name.

- Model group



Details: The irregular octagon with a plus sign indicates a model group. A model group allows you to define and reuse element declarations.

Note: When the model group is declared (in Schema Overview) it is given a name. You subsequently define its content model (in Content Model View) by assigning it a child compositor that contains the element declarations. When the model group is used, it is inserted as a child, or inserted or appended within the content model of some other component (in Content Model View).

- Wildcards

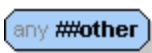

Details: The irregular octagon with `any` at left indicates a wildcard.

Note: Wildcards are used as placeholders to allow elements not specified in the schema or from other namespaces. `##other` = elements can belong to any namespace other than the target namespace defined in the schema; `##any` = elements can belong to any namespace; `##targetNamespace` = elements must belong to the target namespace defined in the schema; `##local` = elements cannot belong to any namespace; `anyURI` = elements belong to the namespace you specify.

Miscellaneous objects

Miscellaneous objects are attributes, attribute groups, assertions, identity constraints, and open content.

- Attributes, Attribute Groups



Details: Indicated with the word '*attributes*' in italics in a rectangle that can be expanded. Each attribute is shown in a rectangle with a (i) dashed border if the attribute is optional, or (ii) a solid border if the attribute is required (mandatory). Attribute groups and attribute wildcards are also included in the '*attributes*' rectangle.

Note: Attributes can be edited in the diagram and in the Details Entry Helper. Attributes can be displayed in the Content Model View diagram or in the [AAIDC pane](#)²³⁷ below the Content Model View. You can toggle between these two views by clicking the Display Attributes  icon. To change the order of attributes of an element, drag the attribute and drop when the arrow appears at the required location.

- Assertions

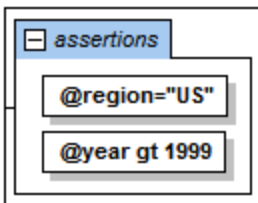

Details: Indicated with the word '*assertions*' in italics in a rectangle that can be expanded. Each assertion is shown in a rectangle within the Assertions box.

Note: Assertions can be edited in the diagram and in the Details Entry Helper. They can be displayed in the Content Model View diagram or in the [AAIDC pane](#)²³⁷ below the Content Model View. You can toggle between these two views by clicking the Display Assertions  icon. To change the order of assertions on an element, drag the assertion and drop when the arrow appears at the required location.

- Identity constraints

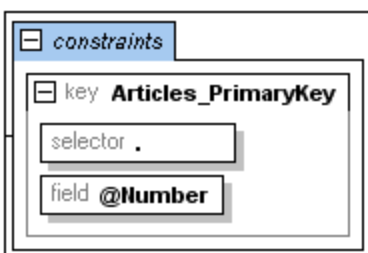

Details: Indicated with the word '*constraints*' in italics in a rectangle that can be expanded.

Note: The identity constraints listed in the content model of a component show constraints as defined with the `key` and `keyref` elements, and with the `unique` element. Identity constraints defined using the `ID` datatype are not shown in the content model diagram, but in the Details Entry Helper. Identity constraints can be displayed and edited in the Content Model View or in the Identity Constraints tab of Schema Overview. In Content Model View, you can toggle the Constraints box on and off with the Display Constraints  icon.

- Conditional Type Assignment

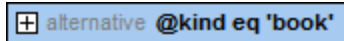

Details: The `alternative` element is a rectangle containing the XPath expression that will be tested (see screenshot above). The type of the `alternative` element is specified in the Details entry helper. If the type is a complex type, it is shown in the `alternative` element's expanded rectangle and can be further edited there (see screenshot below). Simple types are not shown in the diagram, but can be defined in the Simple Type tab of the Details entry helper.

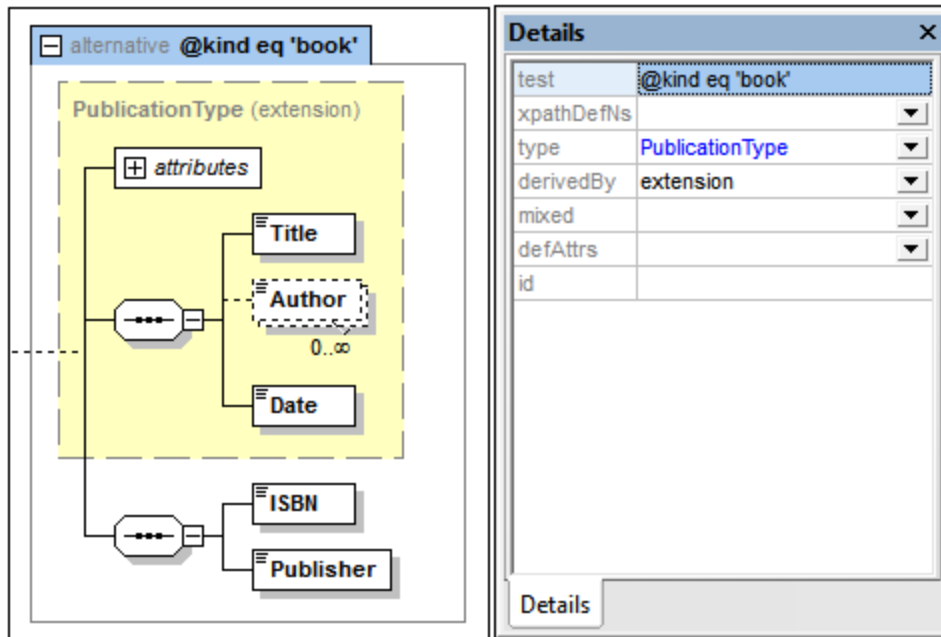

Note: The `alternative` element is new in XSD 1.1. If the XPath expression evaluates to true, the type specified by the `alternative` element will be the selected type. The first `alternative` element from among the `alternative` siblings to evaluate to true is selected. So the order of `alternative` elements is important. The order can be changed by dragging the `alternative` element boxes into the desired order. See the section [Conditional Type Assignment](#)²³⁰ for a detailed description.

- Default Open Content, Open Content

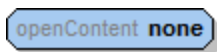

Details: The `defaultOpenContent` and `openContent` elements are indicated in Content Model View with the labels `openContent` and `defOpenContent`. Wildcard element content is indicated with an `any` box (see screenshot above).

Note: The `defaultOpenContent` and `openContent` elements are new in XSD 1.1. Default Open Content is a global component and is created in [Schema Overview](#)²⁰⁴. In the Content Model View of a particular component's content model, you can replace the Default Open Content with Open Content specific to that component that overrides the schema's Default Open Content. Simply add Open Content as a child of the component. The Default Open Content box will be replaced by an Open Content box. In Content Model View, you can edit the `mode` attribute of the Open Content and the namespace of its wildcard element, both in the diagram and in the Details entry helper. You can also modify the Default Open Content (for the whole schema) from within its representation in the Content Model View of any complex type.

Note:

- Predefined details you have specified in the [Schema Display Configuration dialog](#)⁸⁹³ can be turned on and off by clicking the Add Predefined Details  toolbar icon.
- You can toggle Attributes, Assertions, and Identity Constraints to appear either in the diagram of the content model itself or in the [AAIDC pane](#)²³⁷ (below Content Model View) by clicking the Display in Diagram icons for attributes, assertions, and identity constraints, respectively.
- In Content Model View, you can jump to the content model view of any global component within the current content model by holding down the **Ctrl** key and double-clicking the required component.
- The context menu of components contain commands to (i) go to the definition of a component, and (ii) go to the type definition of a component, if these exist.

4.4.3.2 Editing in Content Model View

The description of how to edit in Content Model View is organized into the following sections:

- [Configuring Content Model View](#)²²⁴
- [Attributes, Assertions, and Identity Constraints](#)²²⁵
- [Content Model View icons](#)²²⁵
- [Context menu operations](#)²²⁵
- [Keyboard shortcuts and drag-and-drop](#)²²⁸
- [Component properties](#)²²⁹
- [Annotations](#)²²⁹
- [Comments and processing instructions](#)²³⁰
- [Documenting the content model](#)²³⁰

Configuring Content Model View

You can configure the content model view for the entire schema in the Schema display configuration dialog (**Schema Design | Configure View**). For details about configuration options, see the [Configure View](#)⁸⁹³ section later in the User Reference. Note that the settings you define here apply to the whole schema, and to the schema documentation output as well the printer output.







Attributes, Assertions, and Identity Constraints

The attributes, assertions, and identity constraints of a component can appear in a pane below the Content Model View, the [AAIDC pane](#) ²³⁷, or as boxes in the Content Model View itself, that is, in the diagram. This second viewing option can be set in the [Schema Display Configuration dialog](#) ⁸⁹³. Alternatively, you can use the three **Display in Diagram** toolbar buttons in the Schema Design toolbar (*screenshot below, also see icon list below*).



For a description of how to insert and edit attributes, assertions, and identity constraints, see the section, [Attributes, Assertions, and Identity Constraints](#) ²³⁷.

Content Model View icons

	<i>Show Globals</i> : Available in Content Model View. Switches to Schema Overview ²⁰⁴ .
	<i>Add Predefined Details</i> : In the Schema Design toolbar and enabled in Content Model View. Toggles the display of predefined details in components on and off.
	<i>Display Attributes in Diagram</i> : In the Schema Design toolbar and enabled in Content Model View. Toggles the display of attributes between the diagram (toggled on) and the Attributes tab.
	<i>Display Assertions in Diagram</i> : In the Schema Design toolbar and enabled in Content Model View. Toggles the display of assertions between the diagram (toggled on) and the Assertions tab.
	<i>Display Constraints in Diagram</i> : In the Schema Design toolbar and enabled in Content Model View. Toggles the display of IDCs between the diagram (toggled on) and the Identity Constraints tab.
	<i>Visualize Identity Constraints</i> : In the Schema Design toolbar and enabled in Content Model View. Toggles the display of IDC information on and off.

Context menu operations

Several editing operations in Content Model View are carried out via the context menu (*screenshot below*) that appears when you right-click within Content Model View. Only commands for operations allowed at that point in the content model diagram are enabled. Operations are carried out relative to the right-clicked object. For example, when a child is added, it is added relative to the right-clicked object.

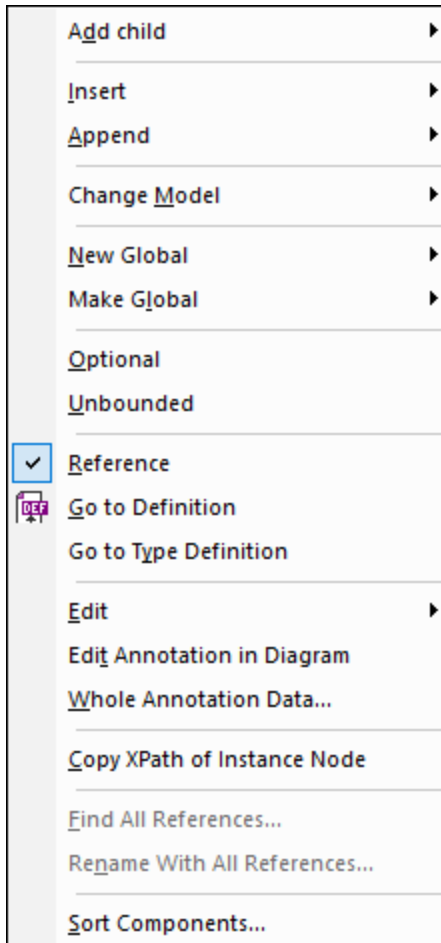

Given below is a list of operations available via the context menu.

- *Add child compositors and components:* The **Add Child** command opens a sub-menu, in which you can select the compositor or component to add.
- *Insert/Append compositors and components:* Inserts the compositor or component at the same hierarchical level as the selected object, before the selected object (**Insert**) or after its last sibling (**Append**).
- *Change a compositor:* Right-click a compositor, select **Change Model | <new compositor>**.
- *Create global components:* (i) The **New Global** command can be accessed by clicking anywhere in Content Model View. It displays a sub-menu in which you can select the new global component to create. (ii) If an object can be created as a global component, the **Make Global** command in its context menu is enabled. On selecting this command, the object will be created as a global component. In Content Model View, it will contain a reference to the newly created global component.
- *Change the occurrence definition:* Use the **Optional** and **Unbounded** toggle commands together to obtain the desired occurrence setting: (i) *optional* = 0 or 1; (ii) *optional* + *unbounded* = 0 to infinity; (iii) *unbounded* = 1 to infinity; (iv) *not optional* + *not unbounded* = 1. (Note: *optional* sets the `minOccurs` attribute of the component, *unbounded* sets the `maxOccurs` attribute.)

- *Toggle between local and global definitions:* If a global element exists that has the same name as a local element, use the **Reference** toggle command to switch between referencing the global definition (toggle on) and using the local definition (toggle off).
- *Go to another content model:* If a component has its own content model (for example, if it references a global component), then the **Go to Definition** command is active, and you can select it to go to the content model. Alternatively, you can press **Ctrl** and double-click the component.
- *Go to the component's type definition:* If a component has a type definition (simple type or complex type), then clicking the **Go to Type Definition** command will take you to the type definition. In the case of built-in simple types, a message box appears that contains information about the simple type.
- *Edit predefined details:* If predefined details have been set to be displayed in the diagram (with the **Add Predefined Details** icon in the Schema Design toolbar), then the **Edit** command displays a submenu containing the predefined details. Select the required predefined detail, and edit its value in the diagram.
- *Create and edit compositor/component annotation:* The **Edit Annotation** command creates annotation space below the compositor/component (see *screenshot below*). You can enter and edit the annotation here. If the annotation already exists, clicking the command highlights the annotation text for editing. Double-clicking existing annotation text is a faster way of starting an edit.



In the XML Schema document, the annotation is created inside the compositor or component's `annotation/documentation` element. *Also see the section below about documentation.*

- *Copy XPath of instance node:* The command **Copy XPath of Instance Node** is enabled for elements and attributes defined within a global element or global complex type. It copies to the clipboard an XPath expression that locates the selected node. The location path expression starts at the global component whose content model is currently being displayed in Content Model View.
- *Find and rename component:* The commands **Find All References** and **Rename with All References** are enabled for global elements. These, respectively, find all occurrences of the selected component and rename all occurrences of the selected component in the active document and, optionally, in all schema files related to the active document.

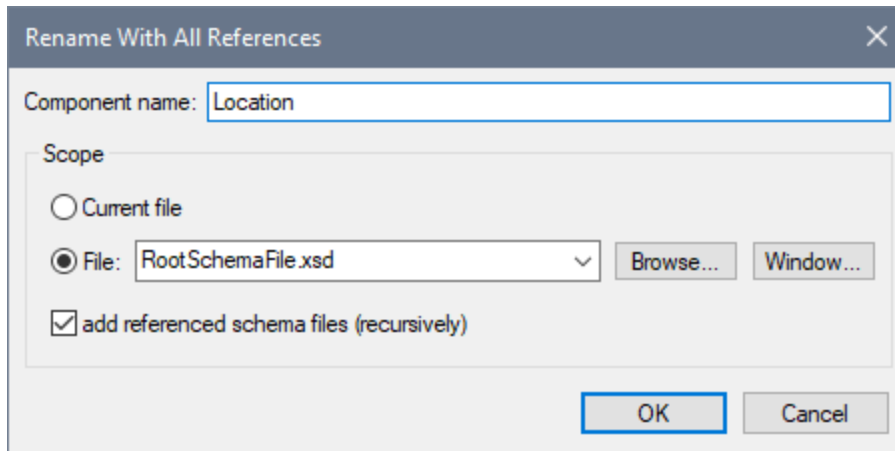

In the screenshot above the name `Email` will replace the name of the right-clicked component and of all its references within the search scope. See [Finding and Renaming Globals](#) ³⁶⁰ for details.

- *Sort declarations and references:* Using the **Sort** command, all selected components or the siblings of the selected component can be sorted. Make your sort settings in the Sort Components dialog (*screenshot below*) and click **OK**.

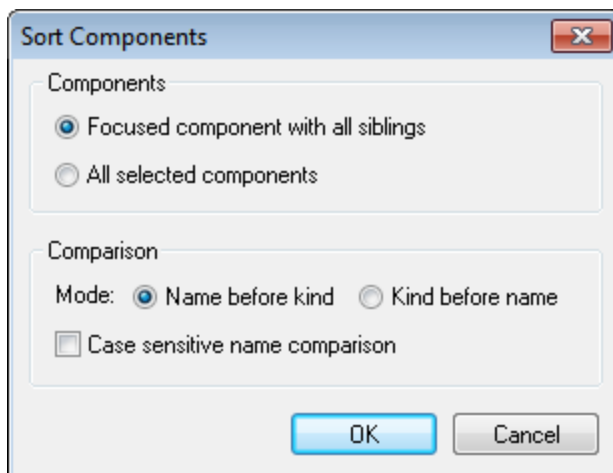

To select multiple components, press the **Shift** or **Ctrl** key while clicking. You can sort using component names as the first sort key and component kind as the second sort key, or vice versa.

Note: You can select a component and copy, cut, delete, or drag it. In few cases, such as attributes of a `complexType` restriction, this might be disallowed,

Keyboard shortcuts and drag-and-drop

You can copy and paste elements in Content Model View using the shortcuts **Ctrl+c** and **Ctrl+v**. Copied objects are pasted as child objects of the selected object. Where this is not possible for structural reasons, a message to this effect is displayed.

You can also drag-and-drop: (i) objects to other locations in the diagram, (ii) some components, such as attributes, from the Components entry helper into the diagram.

Component properties

If Content Model View is configured so that components are displayed with predefined details in the component box, then you can edit this information directly in the diagram. The display of predefined details can be turned on and off by clicking the **Add Predefined Details** toolbar icon (see *icon list above*).

Alternatively, you can edit a component's properties in the [Details entry helper](#)²⁵⁶, and changes will be reflected in the placeholder fields—if these are configured to be displayed.

Annotations

XML Schema annotations are held in the `annotation` element. There are two types of annotation, each of which is contained in a different child element of `annotation`:

- `documentation` child: Contains information that could be useful for editors of the schema
- `appinfo` child: Allows you to insert a script or information that a processing application may use

Given below is the text of an annotation element that contains both types of child elements.

```
<xs:element name="session_date" type="xs:dateTime" nillable="true">
  <xs:annotation>
    <xs:documentation>Date and time when interview was held</xs:documentation>
    <xs:appinfo source="http://www.altova.com/datehandlers/interviews">separator =
  </xs:appinfo>
  </xs:annotation>
</xs:element>
```



In Content Model View, you can create annotation for individual compositors and components as follows.

1. Right-click the compositor or component.

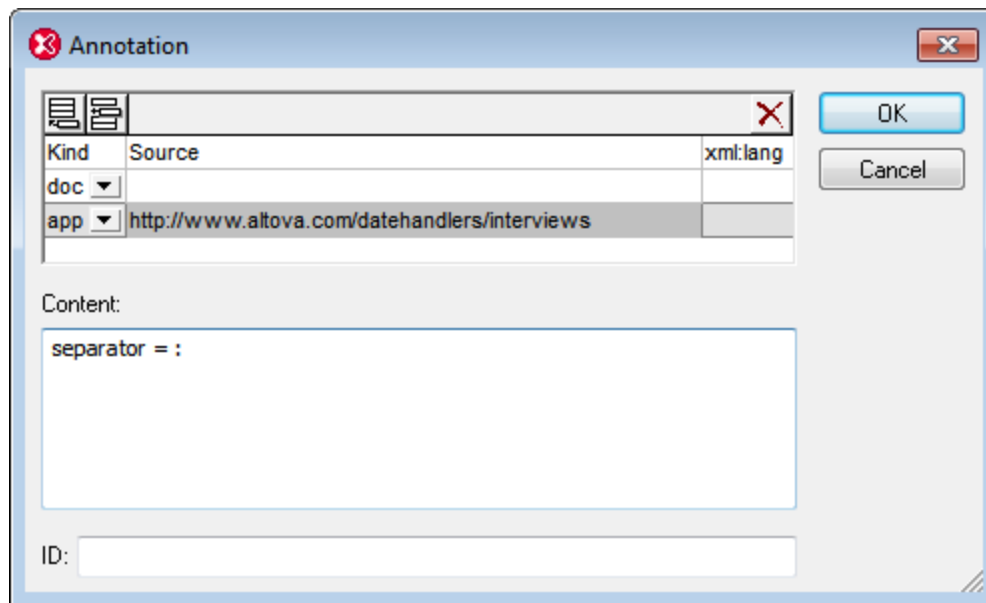

2. Select the context menu option **Whole Annotation Data**. The Annotation dialog box opens (see *screenshot below*). If an annotation (either `documentation` or `appinfo`) exists for that element, then this is indicated by a corresponding row in the dialog.



3. To create an `appinfo` element, click the Append  or Insert  icon at top left to append or insert a new row, respectively.
4. In the *Kind* field of the new row, select the `app` option from the dropdown menu.
5. In the Content pane of the dialog, enter the script or info that you want to have processed by a processing application.
6. Optionally, in the *Source* field, you can enter a source URI where further information can be made available to the processing application.

Comments and processing instructions

When XML Schema documents are loaded in XMLSpy, or when views are changed, comments and processing instructions within simple types and complex types are collected and moved to the end of the enclosing object. It is therefore recommended that you use annotations instead of comments in such cases.

Documenting the content model

You can generate [detailed documentation](#) ⁸⁶⁷ about your schema in HTML and MS Word formats. Detailed documentation is generated for each global component, and the list of global components is displayed in a table-of-contents page that allows you to link to the content models of individual components. Additionally, related elements (such as child elements or complex types) are referenced by hyperlinks, thus enabling you to navigate from element to element. To generate schema documentation, select the menu command **Schema design | Generate documentation**.

4.4.3.3 Conditional Type Assignment

Conditional type assignment is an XSD 1.1 feature that allows the type of an element to be determined by content in the XML document, specifically by the value of the element's attributes or by the presence or absence of attributes. For example, say the XML document has the following element:

```
<publication kind="magazine">
```

```
...
</publication>
```

In the schema, the type of the `publication` element can be specified to vary according to the value of the instance element's `@kind` attribute value. In the schema, this is done using the `alternative` element, which is new in XSD 1.1. Multiple types are specified, each in an `alternative` element.

In the screenshot below, the `Publication` element is declared with three `alternative` child elements, two of which have `test` attributes (`@kind eq 'magazine'` and `@kind eq 'book'`). The third `alternative` element has no `test` attribute and a simple type assignment of `xs:error` (assigned in the Details entry helper, not shown in the diagram), which, if triggered, returns an XML validation error.

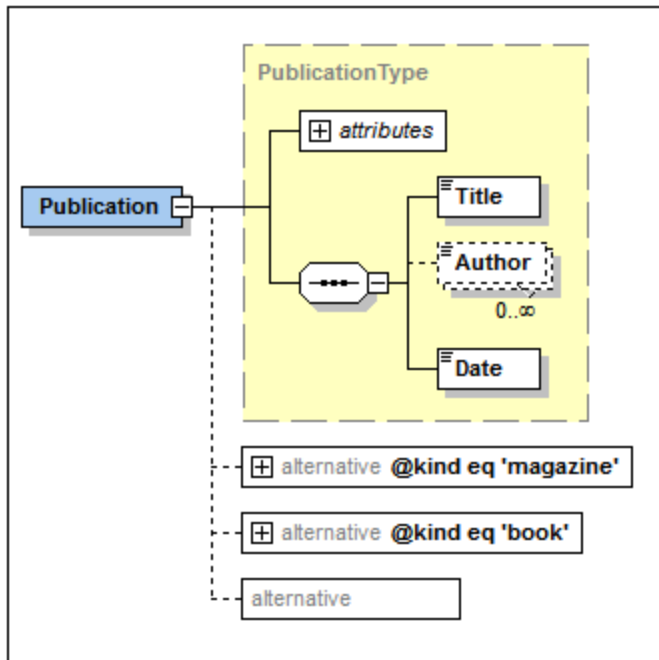

The listing for the above declarations is given below:

```
<xs:complexType name="PublicationType">
  <xs:sequence>
    <xs:element name="Title" type="xs:string"/>
    <xs:element name="Author" type="xs:string" minOccurs="0" maxOccurs="unbounded"/>
    <xs:element name="Date" type="xs:gYear"/>
  </xs:sequence>
  <xs:attribute name="kind" type="xs:string"/>
</xs:complexType>

<xs:complexType name="MagazineType">
  <xs:complexContent>
    <xs:restriction base="PublicationType">
      <xs:sequence>
        <xs:element name="Title" type="xs:string"/>
        <xs:element name="Date" type="xs:gYear"/>
      </xs:sequence>
    </xs:restriction>
  </xs:complexContent>
```

```
</xs:complexType>

<xs:element name="Publication" type="PublicationType">
  <xs:alternative test="@kind eq 'magazine'" type="MagazineType"/>
  <xs:alternative test="@kind eq 'book'">
    <xs:complexType>
      <xs:complexContent>
        <xs:extension base="PublicationType">
          <xs:sequence>
            <xs:element name="ISBN" type="xs:string"/>
            <xs:element name="Publisher" type="xs:string"/>
          </xs:sequence>
        </xs:extension>
      </xs:complexContent>
    </xs:complexType>
  </xs:alternative>
  <xs:alternative type="xs:error"/>
</xs:element>
```

Note the following points:

- The first `alternative` element from among the alternative siblings to evaluate to true is selected. So the order of `alternative` elements is important. In Content Model View, the order can be changed by dragging the `alternative` element boxes into the desired order.
- Notice that the `Publication` element has a type (`PublicationType`). This type serves as the default type if none of the `alternative` elements are used. In our example above, however, the `alternative` element of type `xs:error` will be used if both the previous `alternative` element conditions return false.
- If no `alternative` element condition is met and if the element has no default type, then the element is assigned a type of `anyType`. In this event, the element may have any well-formed XML content.
- The `alternative` element and the simple type `xs:error` are new in XSD 1.1.

Content Model View editing

You can add an `alternative` type to an element declaration as a child via the element's context menu (*see the content model in screenshot above*).

The type of the `alternative` element is specified in the Details entry helper. If the type is a complex type, it is shown in the `alternative` element's expanded rectangle and can be further edited there (*see screenshot below*). Simple types are not shown in the diagram, but can be defined in the Simple Type tab of the Details entry helper.

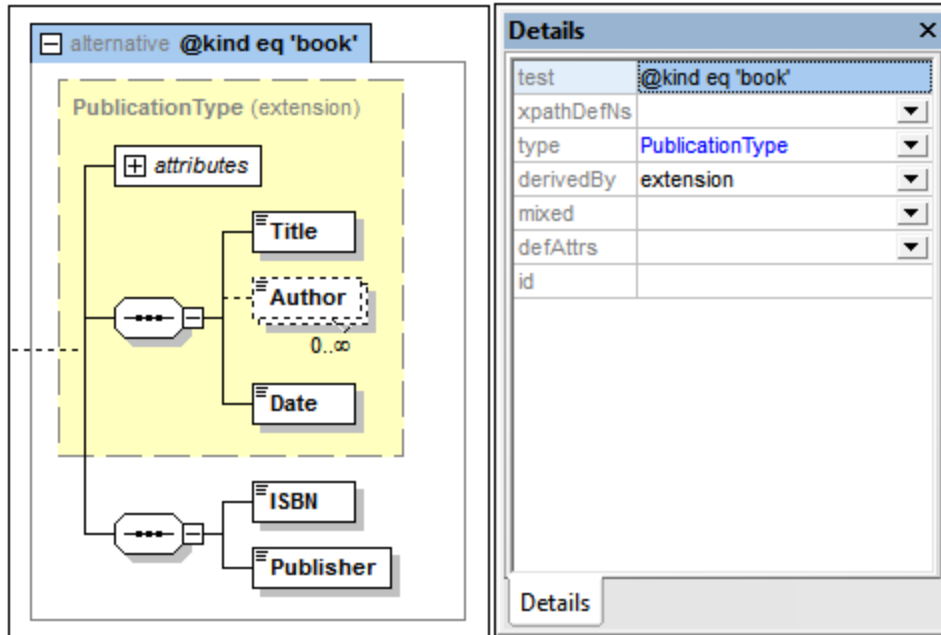

Note: You can specify a namespace for the XPath expression via the `xpathDefaultNamespace` attribute in the Details entry helper. For more information about XPath default namespaces, see the section below.

Using `xpathDefaultNamespace`

A default namespace declared in the XML Schema document is the default namespace of the XML Schema document. It applies to unprefix element names in the schema document—but not to unprefix element names in XPath expressions in the schema document.

The `xpathDefaultNamespace` attribute (a new feature in XSD 1.1) is the mechanism used to specify the namespace to which unprefix element names in XPath expressions belong. XPath default namespaces are scoped on the XML Schema elements on which they are declared. The `xpathDefaultNamespace` attribute can occur on the following XML Schema 1.1 elements:

- `xs:schema`
- `xs:assert` and `xs:assertion`
- `xs:alternative`
- `xs:selector` and `xs:field` (in identity constraints)

The `xpathDefaultNamespace` on `xs:schema` is set, in XSD 1.1 mode, in the Schema Settings dialog (**Schema Design | Schema Settings**). For the other elements listed above, the `xpathDefaultNamespace` attribute is set in their respective Details entry helpers (see screenshot below for example).

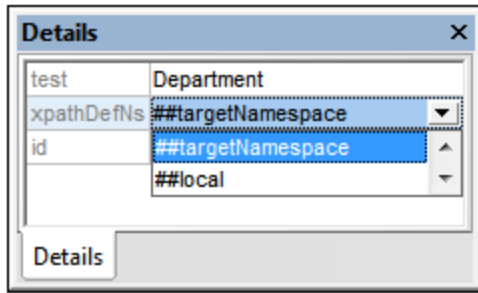

Declaring the XPath default namespace on `xs:schema`, declares the XPath default namespace for the scope of the entire schema. You can override this declaration on elements where the `xpathDefaultNamespace` attribute is allowed (see list above).

Instead of containing an actual namespace, the `xpathDefaultNamespace` attribute can contain one of three keywords:

- `##targetNamespace`: The XPath default namespace will be the same as the target namespace of the schema
- `##defaultNamespace`: The XPath default namespace will be the same as the default namespace of the schema
- `##local`: There is no XPath default namespace

If no XPath default namespace is declared in the document, unprefix elements in XPath expressions will be in no namespace.

Note: The XPath default namespace declaration does not apply to attributes.

4.4.3.4 Open Content Models

Open content models are new to XSD 1.1. They are declared on complex types and allow any element (that is, an element undefined in the content model of the complex type) to occur any number of times either (i) between elements defined in the content model, or (ii) after elements defined in the content model.

The `openContent` element is a child of the complex type and occurs once before the content model of the complex type (see screenshot below).

Mode

The `openContent` element has a mandatory `mode` attribute, which can take the values `interleave`, `suffix`, or `none` (see screenshot below). The default value is `interleave`.

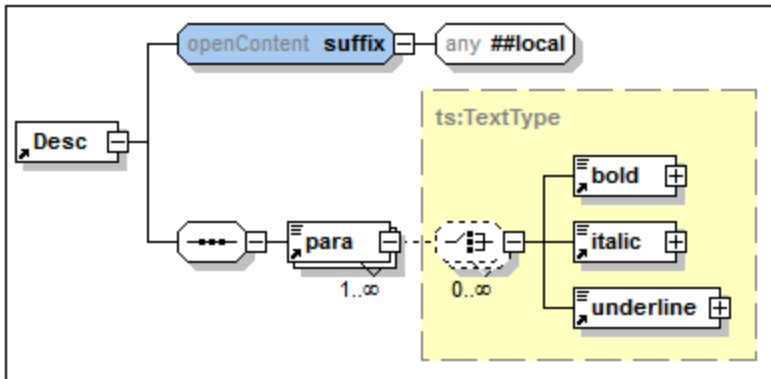

The significance of these values is as follows:

- If `mode="interleave"` or `mode="suffix"`, then wildcard element content (`xs:any`) with no minimum or maximum number of occurrences must be present. This implies that any number of undefined elements (wildcards) is allowed.
- If the mode is `interleave`, any number of undefined elements can occur before or after individual defined elements in the content model. They are interleaved between defined elements.
- If the mode is `suffix`, any number of undefined elements can occur after the last defined element of the content model.
- If the mode is `none`, no undefined element (`xs:any child`) may occur; the content model is not open. The `none` value is used to override the [defaultOpenContent](#)²⁰⁸ element that is scoped on the entire schema.

In Content Model View, you add open content as a child of the complex type (via **Add Child** in the context menu). Specify the mode either by double-clicking in the `openContent` box in the diagram (see *screenshot above*) and selecting a value (`interleave`, `suffix`, or `none`), or by selecting a value in the Details entry helper.

Wildcard (`xs:any`) properties

Wildcard properties are specified in the wildcard's Details entry helper. Select the wildcard in the diagram and enter property values in the Details entry helper.

Default open content

The `defaultOpenContent` element is new in XSD 1.1 and specifies that one or more undefined elements can be added to any complex type of mixed or element-only content. It is similar to the `openContent` element (also new to XSD 1.1), the main difference being that while the `openContent` element applies to a single complex type, the `defaultOpenContent` element applies to all complex types in the schema.

The `defaultOpenContent` element is a [global component](#)²⁰⁸ and occurs once in the document (see *screenshot below*), after Includes, Imports, Redefines, and Overrides, and before the definitions of components. It has a `mode` attribute which can take a value of either `interleave` or `suffix`. The default is `interleave`.

import	loc:address.xsd	ns:http://www.altova.com/IPO	
import	loc:TextState.xsd	ns:http://www.xmlspy.com/schemas/textst:	
defaultOpenContent	suffix	ann:	
notation	Altova-Orgchart	ann:	
complexType	DivisionType	ann:	
element	OrgChart	ann:	

The `defaultOpenContent` element has a content model that you can edit in Content Model View, in exactly the same way as the `openContent` element is defined (see above). Once declared, the `defaultOpenContent` element will apply automatically to all complex types in the schema and will be displayed in their content models. In the screenshot below, you can see that the `defaultOpenContent` has been applied automatically to the `OfficeType` and `Desc` complex types.

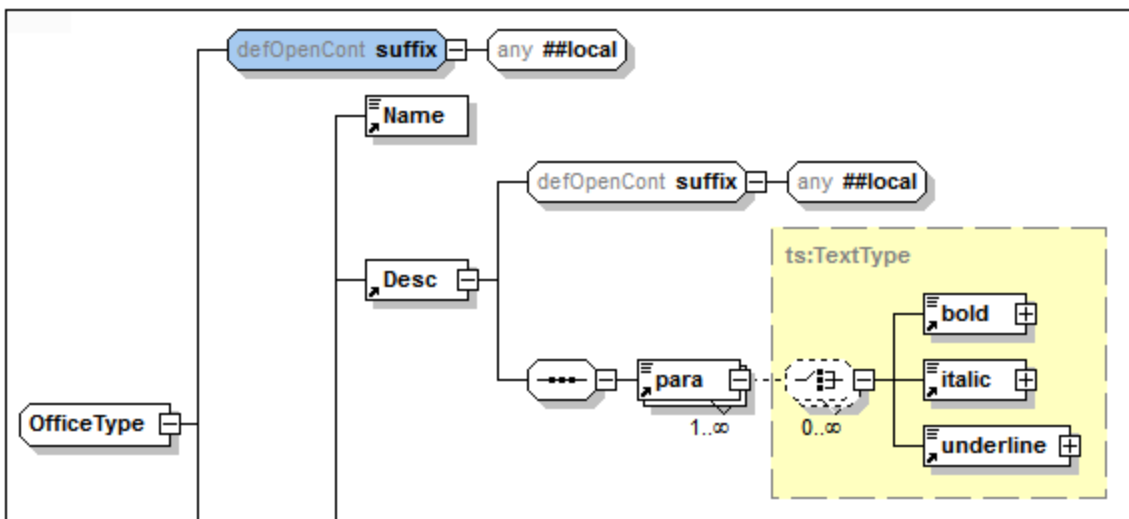

To override the `defaultOpenContent` element when it is applied to a particular complex type, add a child `openContent` element to that complex type. In the screenshot below, the `Desc` element with the `defaultOpenContent` element (see screenshot above) has had an `openContent` element added to it that overrides the `defaultOpenContent` element.

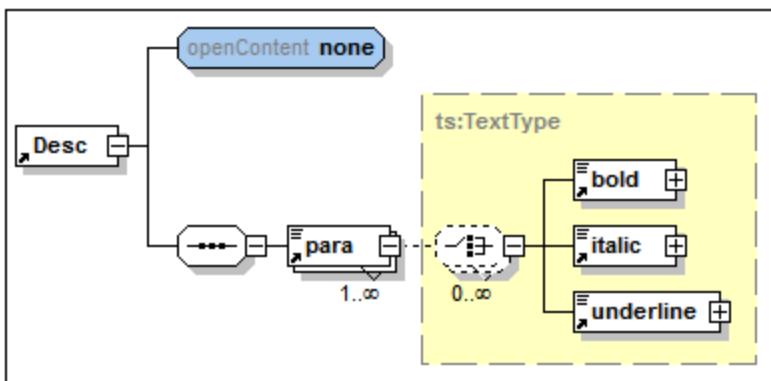

4.4.4 Attributes, Assertions, and Identity Constraints

The Attributes/Assertions/Identity Constraints (AAIDC) pane (*screenshot below*) is located below the main pane in Schema Overview and Content Model View. The pane and its tabs are fixed. In Content Model View, however, the view of each tab can be switched individually so that the tab's components can be viewed and edited in the diagram in Content Model View rather than in the AAIDC pane. When the views of all three tabs are switched to the diagram, the AAIDC pane disappears.

Name	Type	Use	Default	Fixed
currency	xs:string		EUR	
vat	xs:decimal			20
amount	xs:decimal	required		
date	xs:date	optional		
lang	xs:string			EN

Views can be switched between the AAIDC pane and the diagram via the [Schema Display Configuration dialog](#) ⁸⁹³ (**Schema Design | Configure View | Element tab**) or by clicking the respective icon in the Schema Design toolbar (*shown below*).

	<i>Display Attributes in Diagram:</i> Enabled in Content Model View. Toggles the display of attributes between the diagram (toggled on) and the Attributes tab.
	<i>Display Assertions in Diagram:</i> Enabled in Content Model View. Toggles the display of assertions between the diagram (toggled on) and the Assertions tab.
	<i>Display Constraints in Diagram:</i> Enabled in Content Model View. Toggles the display of IDCs between the diagram (toggled on) and the Identity Constraints tab.

Using the tabs

The tabs in the AAIDC become enabled individually according to what component is selected in the upper main pane of Schema Overview or Content Model View. For example, since it is possible to add an attribute to a complex type, the Attributes tab will be enabled when a complex type is selected in the main pane. (A tab is considered to be enabled when its commands are enabled.)

How to use each of the tabs is discussed in the sub-sections of this section:

- [Attributes, Attribute Groups, Attribute Wildcards](#) ²³⁸
- [Assertions](#) ²⁴¹
- [Identity Constraints](#) ²⁴⁵

Sorting attributes and identity constraints

You can sort the attributes and identity constraints in their respective tabs by clicking the **Sort** icon in the tab's toolbar. In the Sort Components dialog that pops up (*screenshot below*), you can choose to sort either the selected single component and its siblings or the set of selected components. In the screenshot above, for example, three attributes have been selected (*highlighted blue*). You can use click+**Shift** to select a range and click+**Ctrl** to add additional components to the selection.

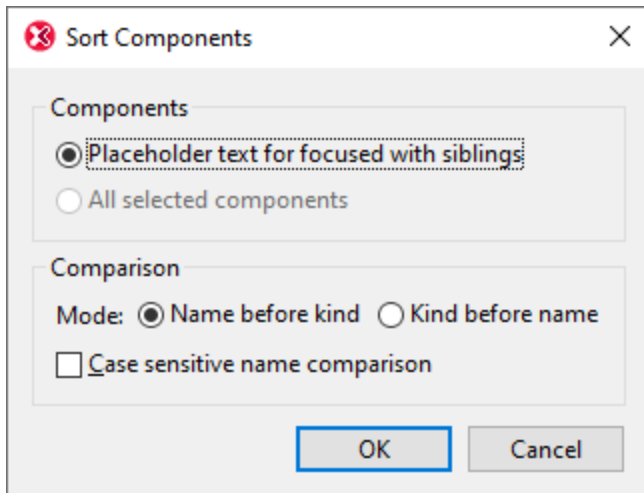

After selecting the set of components to sort you can choose to sort alphabetically first on name and then on kind (*Name before kind*), or vice versa (*Kind before name*). The sort order is immediately implemented in the text of the schema document; it is not just an interface mask.

4.4.4.1 Attributes, Attribute Groups, Attribute Wildcards

In the Attributes tab of the Attributes/Assertions/Identity Constraints (AAIDC) pane (*screenshot below*), you can:

- [Declare attributes locally on the selected complex type](#) ²³⁸
- [Reference attribute groups for use on the selected complex type](#) ²⁴⁰
- [Define attribute wildcards on the selected complex type](#) ²⁴⁰

Note: If you have chosen the option to display attributes in the diagram (**Schema Design | Configure View**) rather than in the AAIDC pane, you can edit the properties of attributes, attribute group references, and attribute wildcards in the diagram and Details entry helper.

	<p><i>Display Attributes in Diagram:</i> Enabled in Content Model View. Toggles the display of attributes between the diagram (toggled on) and the Attributes tab.</p>
--	--

Attributes

In the Attributes tab of the Attributes/Assertions/Identity Constraints (AAIDC) pane (*screenshot below*), you can declare local attributes of elements and complex types, and the attributes that constitute attribute groups.

Name	Type	Use	Default	Fixed
currency	xs:string		EUR	
vat	xs:decimal			20
amount	xs:decimal	required		
date	xs:date	optional		
lang	xs:string			EN

To create attributes, do the following:

1. In Schema Overview, select the complex type or attribute group for which you wish to create the attribute.
2. In the Attributes tab, click the **Append** or **Insert** icon at top left and select **Attribute**.
3. In the row that is created for the attribute, enter the attribute's details (name, type, use, and default or fixed value). The `name` property is mandatory, and the default value of `use` is `optional`. The datatype and default/fixed value properties are optional.

Note: Attributes can be added to attribute groups only in [Schema Overview](#)¹⁹⁸, but to complex types in both [Schema Overview](#)¹⁹⁸ and [Content Model View](#)¹⁹⁸.

Note: If an attribute has a type definition, then clicking its context menu command **Go to Type Definition** will take you to the type definition. In the case of built-in simple types, a message box appears that contains information about the simple type.

Default values and fixed values

A default value or fixed value, if specified in an attribute declaration, is applied in the instance document when that attribute is absent in the instance document. Either a default value or a fixed value can be specified, not both (see *screenshot above*). The default or fixed value must be valid according to the attribute's datatype. If `use` is set to `required`, then neither default nor fixed value is allowed.

Note the following:

- *Default values:* A default value is inserted only if the attribute is missing. If the attribute is present and has a valid value, the default value is not inserted. If the value in the instance documents is invalid, an error is raised.
- *Fixed values:* A fixed value is applied not only when the attribute is missing but also if the value in the instance document is not equal to the fixed value specified in the attribute's declaration.

Note: Default and fixed values can be specified on both local and global attributes. On local attributes they can be defined in both the Attributes tab of the AAIDC pane (*screenshot above*) and in the Details entry helper. On global attributes, they can be specified in the Details entry helper.

Attribute group references

If a global attribute group has been declared, you can add a reference to this attribute group in the definition of a complex type. Do this by selecting the complex type component in Schema Overview or Content Model View, then clicking the **Append** or **Insert** icon at top left of the Attributes tab of the AAIDC pane and selecting **Attribute Group**. In the attribute group row that is created, enter the name of the attribute group to be referenced (see screenshot below, which has two attribute group references). You can add multiple attribute groups.

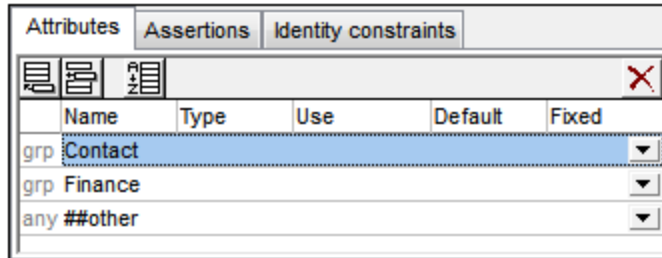

When the attribute group is selected in the Attributes tab, its properties can also be edited in the Details entry helper.

Attribute wildcards: anyAttribute

An attribute wildcard can be added to a complex type to allow the use of any attribute on an element. An attribute wildcard is defined with a single `anyAttribute` element. It would allow any number of attributes from the specified namespace to occur on the element in the instance document.

Add an attribute wildcard by selecting the complex type component in Schema Overview or Content Model View, then clicking the **Append** or **Insert** icon at top left of the Attributes tab of the AAIDC pane and selecting **Any Attribute**. A row for the attribute wildcard `anyAttribute` is created (see screenshot below).

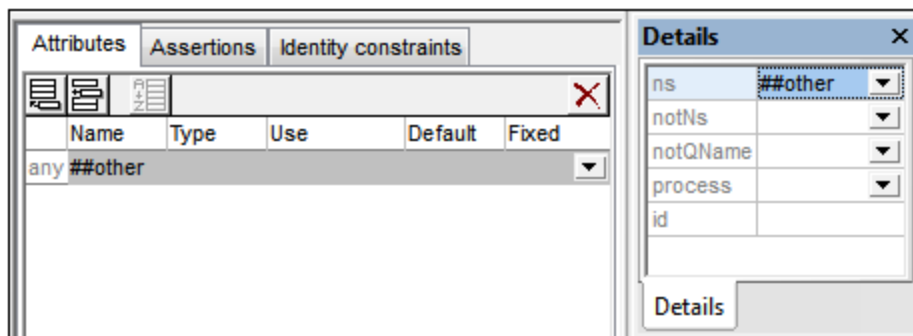

In the Attributes tab, you can set the `namespace` property of `anyAttribute`. With the attribute wildcard selected in the Attributes tab, you can set additional properties in the Details entry helper (see screenshot above). Note that the `notNamespace` and `notQName` properties are [XSD 1.1 features](#) ²⁰⁰ and so will not be available in [XSD 1.0 mode](#) ²⁰⁰.

Sorting attributes and attribute groups

You can sort the attributes and attribute groups in the Attributes tab by clicking the **Sort** icon in the tab's toolbar. In the Sort Components dialog that pops up (screenshot below), you can choose to sort either the

selected single component and its siblings or the set of selected components. You can use **Shift**+click to select a range and **Ctrl**+click to add additional components to the selection.

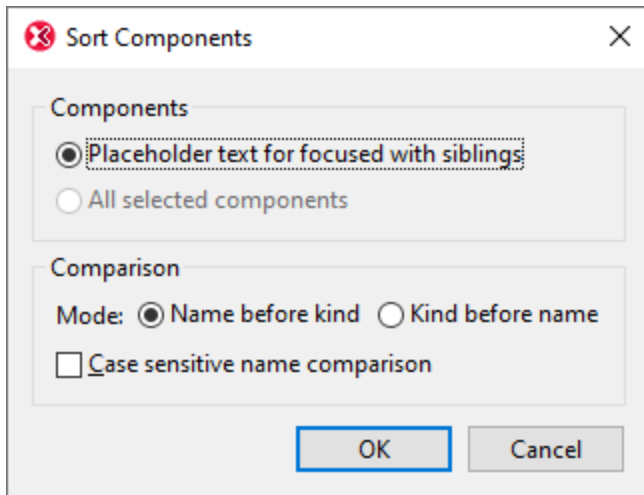

After setting the range you can choose to sort the entire range of attributes and attribute groups alphabetically (*Name before kind*), or attributes sorted alphabetically before attribute groups sorted alphabetically.

The sort order is immediately implemented in the text of the schema document; it is not just an interface mask.

Note: Attribute wildcards will not be included in the range to sort since they must always occur at the end of a complex type declaration and only one attribute wildcard is allowed in a single complex type declaration.

4.4.4.2 Assertions

The assertions described in this section are **assertions on complex types**. Such an assertion is defined in an `xs:assert` element, which was **introduced in XML Schema version 1.1**, and serves as a validity constraint on the complex type. (The other kind of assertion is an assertion on a simple type, which is defined in an `xs:assertion` element and is created and edited in the [Facets entry helper](#)²⁰⁰ of a simple type. That kind of assertion is not covered by the feature described in this topic.)

Note: Assertions are an XSD 1.1 feature. So the Assertions editing features will be available only in [XSD 1.1 mode](#)²⁰⁰.

Where to edit assertions

In Schema View, complex type assertions can be created and edited via the following GUI access points:

- *In Schema Overview:* In the Assertions tab of the Attributes/Assertions/Identity-Constraints (AAIDC) pane (*screenshot below*). In order for the Assertions tab to be enabled, [change the XSD mode](#)²⁰⁰ to 1.1 (for instance, via the **XSD 1.1** toolbar icon).

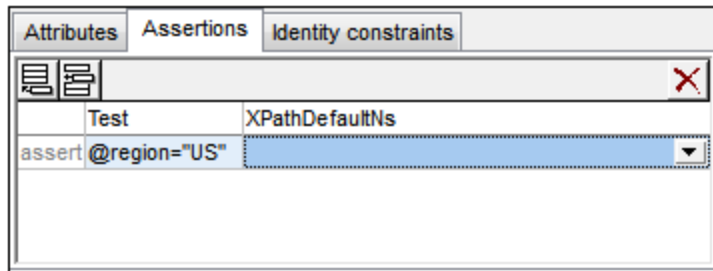

- In *Content Model View*: Assertions can be edited in the Assertions tab (screenshot above) or in the diagram (screenshot below). Only one of these two editing options (tab or diagram) is enabled at a given time. You can switch between them by toggling off/on the **Display Assertions in Diagram** icon in the Schema Design toolbar (see below). (To set one of these options as the default, go to the Schema Display Configuration dialog (**Schema Design | Configure View | Element tab**.) In the diagram, select the Assertion box of the complex type or complex-content element. Then enter or edit the Assertion's definition directly or in the Details entry helper.

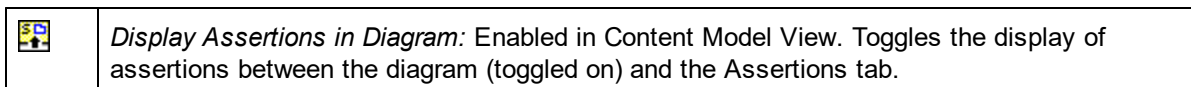
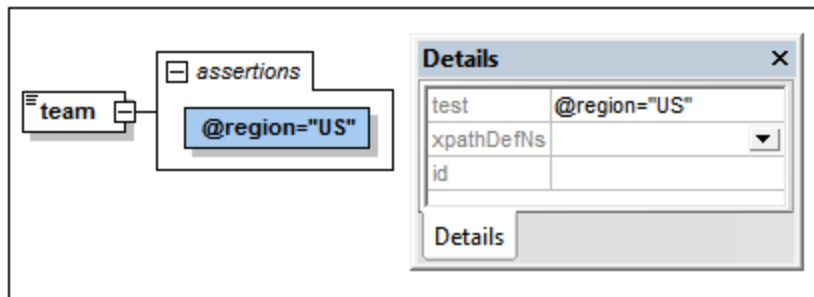

Scope of the assertion

The XPath expression used to define the assertion's constraint must be within the scope of the complex type on which it is defined. So if the XPath expression is required to access a particular node, then the assertion must be defined on an ancestor of that node.

Adding and deleting assertions

A complex type can have multiple assertions. The XPath expression of each assertion must evaluate to boolean `true` for the element in the instance document to be valid. To add an assertion to a complex type, do the following:

- In *Schema Overview*: Select the complex type. Then, in the Assertions tab of the AAIDC pane (see screenshot above), click the **Add** or **Insert** icon at the top left of the tab. You can add multiple assertions. To delete an assertion, select it and click the **Delete** icon at the top right of the tab.
- In *Content Model View* (see screenshot above): Right-click the complex type and select **Add Child | Assertion**. Alternatively, right-click an existing assertion in the diagram of the complex type and select **Append | Assertion** or **Insert | Assertion**. You can add multiple assertions to a complex type. To delete an assertion, select it and press the **Delete** key.

Defining the assertion's XPath expression

The XPath expression of a complex type assertion defines the validation constraint to be applied on the complex type element in the instance document. For example, in the screenshots above, the assertion is on the complex-type element `team` and the assertion's XPath expression is: `@region="US"`. In the XML Schema document, the assertion appears as:

```
<xs:assert test="@region="US""/>
```

The assertion specifies that, in the instance document, the `team` element must have a `region` attribute with a value of `us`. If it does not, the document will be invalid.

Note the following points:

- XPath expressions must be written in the XPath 2.0 language
- Nodes tested in the XPath expression must be within the scope of the assertion (*see above*)
- If an expression does not evaluate to boolean `true/false`, the returned value is converted to a boolean value. A non-empty sequence is converted to `true`, while an empty sequence is converted to `false`.
- Syntax errors in the expression are flagged by displaying the expression in red. Context errors are not flagged. For example, if the XPath expression tests an attribute and that attribute is not defined in the schema, no error is flagged.

The assertion's message

It is very useful if an explanation of the assertion is supplied together with its definition, so that in case the assertion is not fulfilled when the XML instance document is validated, an appropriate message can be displayed. Since the XML Schema specification does not make provision for such a message, XMLSpy allows a message in the Altova `xml-schema-extensions` namespace <http://www.altova.com/xml-schema-extensions> (or any other namespace) to be provided with the definition of the assertion and to be used in the validation of the XML instance document. For example:

```
<xs:assert test="count(//MyNode) ge 1" altova:message="There must be at least one MyNode element"/> OR  
<xs:assertion test="count(//MyNode) ge 1" altova:message="There must be at least one MyNode element"/>
```

If the restriction specified in the assertion is not fulfilled, XMLSpy's validation engine will display, along with the validation-error message, the message associated with the assertion as a hint. The validator will report the value of an `assert/@message` attribute or of an `assertion/@message` attribute regardless of the namespace in which the `message` attribute is. However, in Schema View, you can edit only `message` attributes that are in the Altova `xml-schema-extension` namespace. To edit `message` attributes in other namespaces, use Text View.

See [Assertion Messages](#) ²⁶³ for details.

Using `xpathDefaultNamespace`

A default namespace declared in the XML Schema document is the default namespace of the XML Schema document. It applies to unprefixed element names in the schema document—but not to unprefixed element names in XPath expressions in the schema document.

The `xpathDefaultNamespace` attribute (a new feature in XSD 1.1) is the mechanism used to specify the

namespace to which unprefixed element names in XPath expressions belong. XPath default namespaces are scoped on the XML Schema elements on which they are declared. The `xpathDefaultNamespace` attribute can occur on the following XML Schema 1.1 elements:

- `xs:schema`
- `xs:assert` and `xs:assertion`
- `xs:alternative`
- `xs:selector` and `xs:field` (in identity constraints)

The `xpathDefaultNamespace` on `xs:schema` is set, in XSD 1.1 mode, in the Schema Settings dialog (**Schema Design | Schema Settings**). For the other elements listed above, the `xpathDefaultNamespace` attribute is set in their respective Details entry helpers (see screenshot below for example).

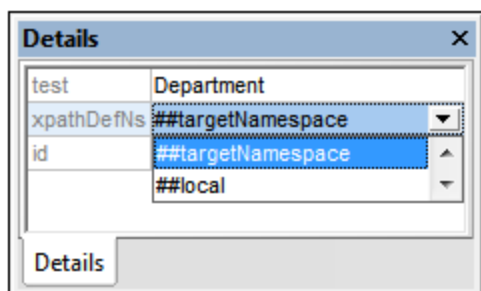

Declaring the XPath default namespace on `xs:schema`, declares the XPath default namespace for the scope of the entire schema. You can override this declaration on elements where the `xpathDefaultNamespace` attribute is allowed (see list above).

Instead of containing an actual namespace, the `xpathDefaultNamespace` attribute can contain one of three keywords:

- `##targetNamespace`: The XPath default namespace will be the same as the target namespace of the schema
- `##defaultNamespace`: The XPath default namespace will be the same as the default namespace of the schema
- `##local`: There is no XPath default namespace

If no XPath default namespace is declared in the document, unprefixed elements in XPath expressions will be in no namespace.

Note: The XPath default namespace declaration does not apply to attributes.

For XPath expressions in assertions, you can also specify the XPath default namespace on the definition of the assertion. In the Assertions tab of the Attributes/Assertions/Identity-Constraints (AAIDC) pane (screenshot below), select the required keyword from the dropdown list of the `XPathDefaultNS` field.

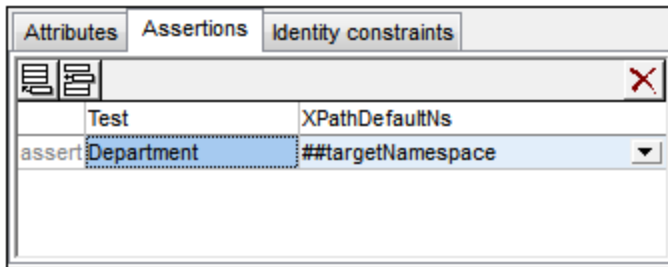

The selected namespace will be in scope on the assertion.

4.4.4.3 Identity Constraints

Identity constraints (IDCs) can be defined on global or local element declarations. They specify the uniqueness of nodes and enable correct referencing between unique nodes.

Declaration mechanisms

The following mechanisms are available for defining an IDC (`unique`, `key`, `keyref`):

- In [Schema Overview](#)²⁰⁴, IDCs can be declared on global elements. Select a global element and define IDCs in the Identity Constraints tab of the Attributes/Assertions/Identity-Constraints (AAIDC) pane (*screenshot below*).

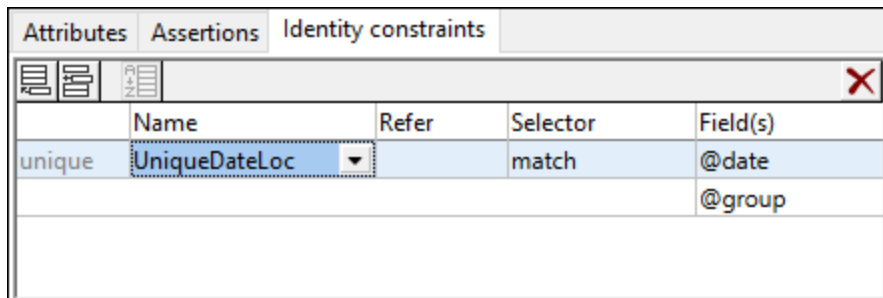

Add an IDC (`unique`, `key`, `keyref`) using the **Insert** or **Append** icon of the Identity Constraints tab. These icon can also be used to add a `field` to the selected IDC. Use the **Delete** icon to delete the selected `field` or IDC.

- In the [Content Model View](#)²¹⁶ of a global element, IDCs can be defined on the global element or on a local descendant element. In this view, IDCs can be edited either in the Identity Constraints tab (*screenshot above*) or in an element's *Constraints* box in the diagram (*screenshot below*, in which the `match` element has a uniqueness constraint that has a `team` selector). The latter alternative can be selected in the Schema Display Configuration dialog (**Schema Design | Configure View**). Alternatively, you can click the **Display Constraints in Diagram** icon in the Schema Design toolbar. The diagram provides a graphical representation of IDCs and drag-and-drop editing functionality.

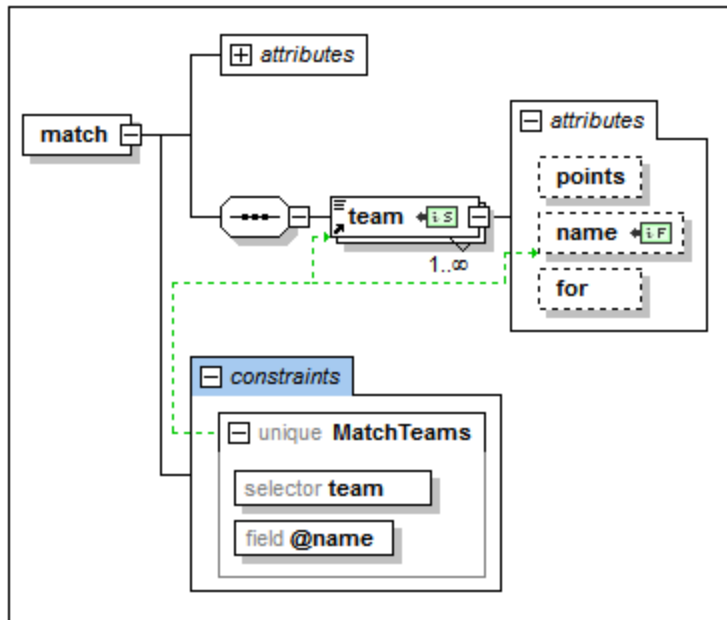

To add an IDC (unique, key, keyref) in the diagram when diagram mode for IDCs is switched on, right-click the element to be constrained and select **Add Child | [IDC]** from the context menu. The `field` item will be enabled in the context menu only when an IDC is selected in the diagram. Press the **Delete** key to delete the selected `field` or IDC.

The XPath expression can be entered in the `selector` and `field` boxes in one of three ways: (i) by typing it in, (ii) by selecting the required node from a dropdown list that appears automatically when you click in the `selector` or `field` box, or (iii) by dragging the target node into the `selector` or `field` box and dropping it when the box becomes highlighted; the XPath expression will be created automatically.

Note: Additionally, an [overview of all identity constraints](#) ²⁵² in the schema is available in the Identity Constraints tab of the Components entry helper.

Identity constraint icons

	<i>Display Constraints in Diagram:</i> Enabled in Content Model View. Toggles the display of IDCs between the diagram (toggled on) and the Identity Constraints tab.
	<i>Visualize Identity Constraints:</i> Enabled in Content Model View. Toggles the display of IDC information on and off.
	<i>Selector node, Field node:</i> Seen in node boxes in the diagram, these two icons identify, respectively, the node selected (in IDCs) by the XPath expression for <code>selector</code> and for <code>field</code> .

Visualizing IDCs

When the Visualize Identity Constraints icon is toggled on, IDC information is displayed in the diagram and can be visualized better. When visualization is toggled on, nodes selected by the `selector` and `field` XPath

expressions are indicated with icons in their boxes (see *icons section above*), and the IDC box is connected to its selector and field boxes with green lines (see *screenshot above*).

The Visualize ID Constraints icon also switches on IDC validation functionality in Schema View. If an XPath expression is incorrect or an IDC is otherwise incorrect, errors are indicated with red text, warnings with orange text. On validating the XML Schema document, error or warning messages are displayed in the Messages window.

You can also disable validation by toggling the Visualize ID Constraints icon  off.

XML listing

The IDC examples further below in this section are based on the following valid instance document.

```
<results xmlns:xsi="http://www.w3.org/2001/XMLSchema-instance"
  xsi:noNamespaceSchemaLocation="Scores.xsd">
  <!-- Groups -->
  <group id="A">
    <team name="Brazil"/>
    <team name="Germany"/>
    <team name="Italy"/>
    <team name="Holland"/>
  </group>
  <group id="B">
    <team name="Argentina"/>
    <team name="France"/>
    <team name="England"/>
    <team name="Spain"/>
  </group>
  <!-- Matches -->
  <match group="A" date="2012-06-12" location="Munich">
    <team name="Brazil" for="2" points="3"/>
    <team name="Germany" for="1" points="0"/>
  </match>
  <match group="A" date="2012-06-12" location="Frankfurt">
    <team name="Italy" for="2" points="1"/>
    <team name="Holland" for="2" points="1"/>
  </match>
  <match group="B" date="2012-06-13" location="Munich">
    <team name="Argentina" for="2" points="3"/>
    <team name="France" for="0" points="0"/>
  </match>
  <match group="B" date="2012-06-13" location="Berlin">
    <team name="England" for="0" points="1"/>
    <team name="Spain" for="0" points="1"/>
  </match>
</results>
```

Uniqueness constraints (unique)

A uniqueness constraint specifies that the value of an element or attribute (or of a set of elements and/or attributes) must be unique within a defined scope. In the XML listing shown above, we wish to ensure that the two teams playing a match are not the same team. So, within the scope of each `match` element, we constrain the values of the `team/@name` node to be unique. We do this as follows.

1. In Schema Overview, select the `match` element. The `match` element will therefore be the scope of the identity constraint definition.
2. In the Identity Constraints tab, click the **Add** or **Insert** icon at the top left of the tab, and, in the menu that pops up, click **Unique**. This adds a row for the uniqueness constraint (see screenshot below).

	Name	Refer	Selector	Field(s)
unique	MatchTeams		team	@name

3. Give the identity constraint a name. (In the screenshot above, `MatchTeams` is the name.)
4. Enter an XPath expression in the *Selector* column to select the `team` element. Note that the `match` element is the context node. The `team` element will now be the IDC's selector, that is, the node to which the uniqueness constraint applies.
5. In the *Field* column, enter the `@name` node that must be unique. The value of this node is the value that must be unique.

The uniqueness constraint described above specifies that within the scope of each `match` element, every `team` element must have a unique `@name` attribute-value.

You can use additional fields to check for uniqueness. For example, a uniqueness constraint can be defined on the `results` element to check that all matches have a unique combination of date and location: Not more than one match may occur at one location on the same date. The uniqueness constraint must have, for each `match` element (the selector), its combination of `@date` and `@location` values unique within the scope of the `results` element.

Define the uniqueness constraint on the `results` element in a similar way to that described above. The selector will be `match`, and the fields will be `@date` and `@location` (see screenshot below). Add the second field by clicking the **Append** icon and then **Field**.

	Name	Refer	Selector	Field(s)
unique	UniqueDateLoc		match	@date @group

Note: The *Refer* column in the Identity Constraints tab is enabled for `keyref` constraints only, not for `unique` or `key` constraints.

Key constraints (key)

A key constraint specifies: (i) that the value of an element or attribute (or of a set of elements and/or attributes) must be unique within a defined scope, and (ii) that these field elements and/or attributes must be present in

the instance XML document; therefore, optional elements or attributes should not be selected as fields of a key constraint. A key constraint is thus (in point (i) above) exactly the same as a uniqueness constraint. It stipulates one additional constraint: that its field elements/attributes must be present in the XML document.

The screenshot below shows a key constraint defined on a `match` element that is similar to the first uniqueness constraint described above.

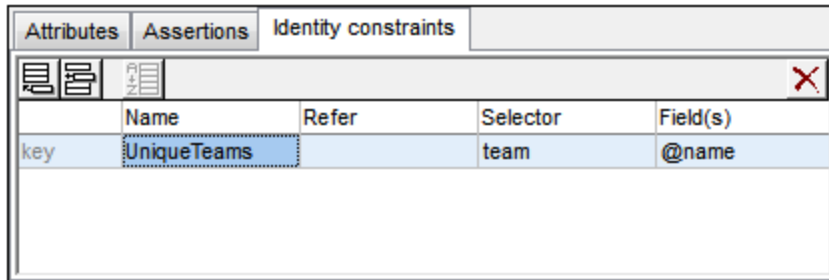

	Name	Refer	Selector	Field(s)
key	UniqueTeams		team	@name

This key constraint specifies that within the scope of each `match` element, every `team` element must have a unique `@name` attribute-value. Additionally, it specifies that the `@name` attribute must be present on every `match/team` element.

Note: The *Refer* column in the Identity Constraints tab is enabled for `keyref` constraints only, not for `unique` or `key` constraints.

Key references (keyref)

Key references check one set of values in an instance document against another. In our XML listing, for example (see *listing above*), we can use a key reference to check whether the teams playing in matches are among the teams listed in the respective groups. If not, the XML document will be invalid.

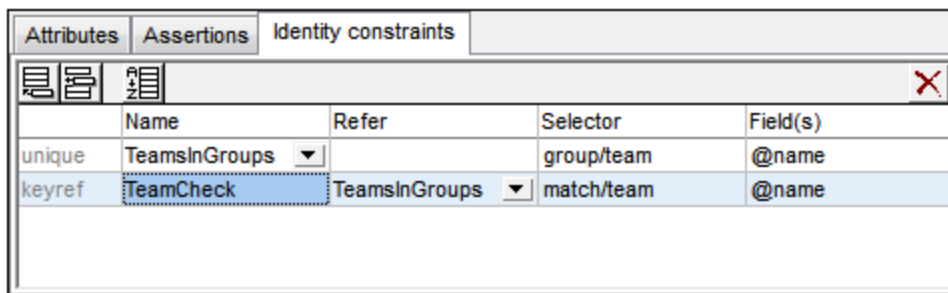

First, we create a uniqueness constant or key constraint. The screenshot below shows a uniqueness constraint (`unique`), `TeamsInGroups`, created on the `results` element. This constraint stipulates that each `team` in `group` has a unique `@name` attribute.



	Name	Refer	Selector	Field(s)
unique	TeamsInGroups		group/team	@name
keyref	TeamCheck	TeamsInGroups	match/team	@name

Next, we create the key reference (`keyref`), `TeamCheck`, which selects the `team` child of `match` and checks whether its `@name` attribute-value is present among the values returned by `TeamsInGroups`, which it references (in the *Refer* column).

The screenshot below shows the graphical display of this key reference (highlighted in blue) together with the Details entry helper (in which you can also select the referenced IDC). The relations of the selected IDC are shown with a solid green line, while unselected IDCs are shown with a dotted green line. Also, for each identity

constraint the node selected by the XPath expression for `selector` and `field` are shown with the icons  and  respectively. If a node is collapsed, the relationship line to it ends with an ellipsis.

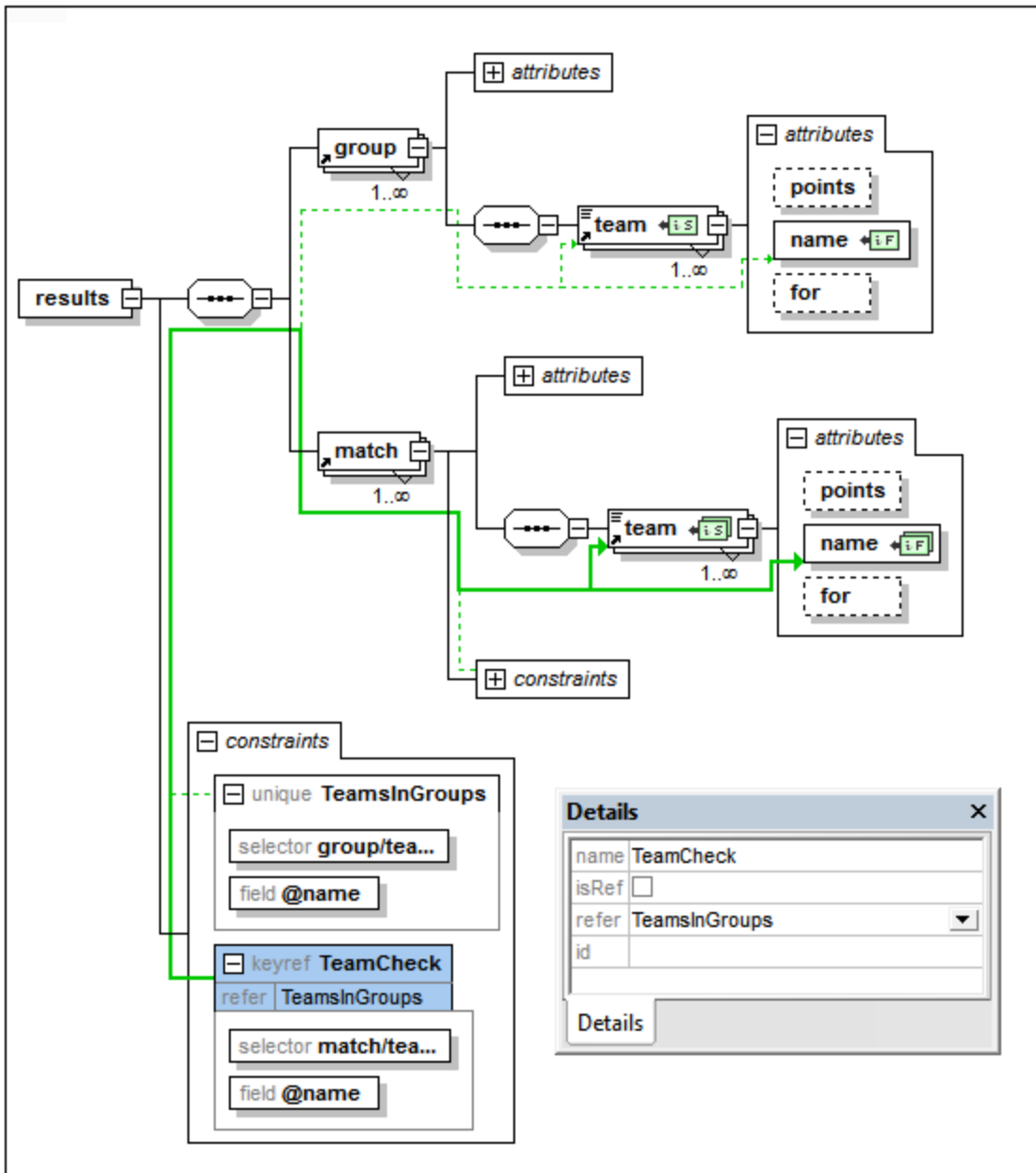

Using `xpathDefaultNamespace`

A default namespace declared in the XML Schema document is the default namespace of the XML Schema document. It applies to unprefix element names in the schema document—but not to unprefix element names in XPath expressions in the schema document.

The `xpathDefaultNamespace` attribute (a new feature in XSD 1.1) is the mechanism used to specify the namespace to which unprefix element names in XPath expressions belong. XPath default namespaces are

scoped on the XML Schema elements on which they are declared. The `xpathDefaultNamespace` attribute can occur on the following XML Schema 1.1 elements:

- `xs:schema`
- `xs:assert` and `xs:assertion`
- `xs:alternative`
- `xs:selector` and `xs:field` (in identity constraints)

The `xpathDefaultNamespace` on `xs:schema` is set, in XSD 1.1 mode, in the Schema Settings dialog (**Schema Design | Schema Settings**). For the other elements listed above, the `xpathDefaultNamespace` attribute is set in their respective Details entry helpers (see *screenshot below for example*).

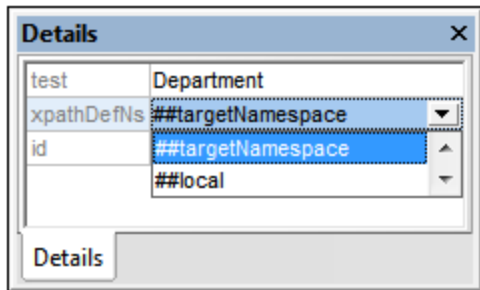

Declaring the XPath default namespace on `xs:schema`, declares the XPath default namespace for the scope of the entire schema. You can override this declaration on elements where the `xpathDefaultNamespace` attribute is allowed (see *list above*).

Instead of containing an actual namespace, the `xpathDefaultNamespace` attribute can contain one of three keywords:

- `##targetNamespace`: The XPath default namespace will be the same as the target namespace of the schema
- `##defaultNamespace`: The XPath default namespace will be the same as the default namespace of the schema
- `##local`: There is no XPath default namespace

If no XPath default namespace is declared in the document, unprefixed elements in XPath expressions will be in no namespace.

Note: The XPath default namespace declaration does not apply to attributes.

IDs of identity constraints

An ID can be assigned to an identity constraint, its selector, and/or field/s. To assign an ID, select the required component and, in the Details entry helper, enter the ID in the `id` row.

Sorting identity constraints

You can sort the IDCs in the Identity Constraints tab by clicking the **Sort** icon in the tab's toolbar. In the Sort Components dialog that pops up (*screenshot below*), you can choose to sort either the selected single component and its siblings, or the set of selected components. You can use click+**Shift** to select a range and click+**Ctrl** to add additional components to the selection.

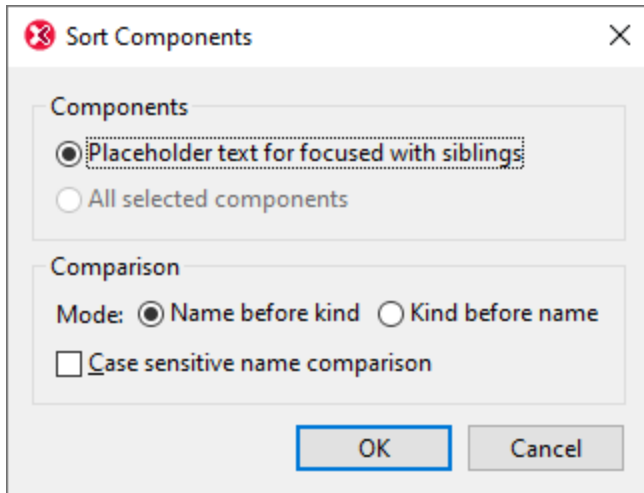

After setting the range you can choose to sort the entire range alphabetically (*Name before kind*), or organized alphabetically by kind (that is: uniqueness constraints first, then key constraints, then key references).

The sort order is implemented in the text of the schema.

4.4.5 Entry Helpers in Schema View

There are three entry helpers in Schema View. They are described in detail in the sub-section of this section:

- [Components entry helper](#)²⁵²
- [Details entry helper](#)²⁵⁶
- [Facets entry helper](#)²⁵⁸

The entry helpers are the same in both Schema Overview and Content Model View. They enable you to graphically add and edit definitions of schema components. Typically you can drag components from an entry helper, or select a component in the design and then define properties for it in an entry helper.

4.4.5.1 Components

The Components entry helper in Schema View (*see screenshots below*) serves three purposes:

- To organize global components in a tree view by component type and namespace (*see screenshots below*). This provides organized overviews of all global components and global components according to namespace.
- To enable you to navigate to and display the Content Model View of a global component—if the component has a content model. If a component does not have a content model, the component is highlighted in the Schema Overview. Global components that are included or imported from other schemas are also displayed in the Components entry helper.
- To provide an overview of the identity constraints defined in the schema document. For a description of the Identity Constraints tab, see [Identity Constraints](#)²⁴⁵.

Note: Whether the built-in datatypes of XSD 1.0 or 1.1 are displayed depends on which XSD mode (XSD 1.0 or 1.1) is selected.

Globals tab

In the Globals tab (see *screenshot below*) global components are grouped in a tree according to their component type. The number of each global component type present in the schema is given next to each component type.

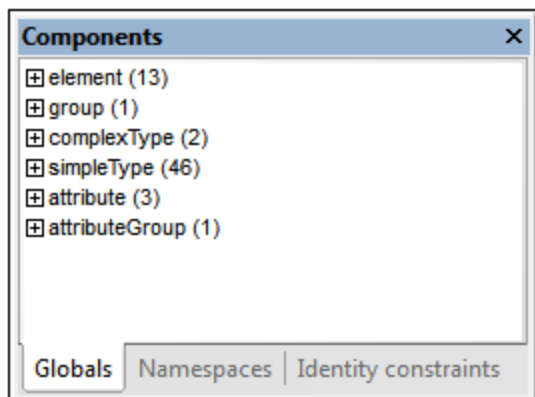

In the tree display, global components are organized into the following seven groups. Note that a component type is listed in a tree only if at least one component of that type exists in the schema.

- Element Declarations (Elements)
- Model Groups (Groups)
- Complex Types
- Simple Types
- Attribute Declarations (Attributes)
- Attribute Groups
- Notations

Namespaces tab

In the Namespaces tab (see *screenshot below*), components are organized first according to namespace and then according to component type.

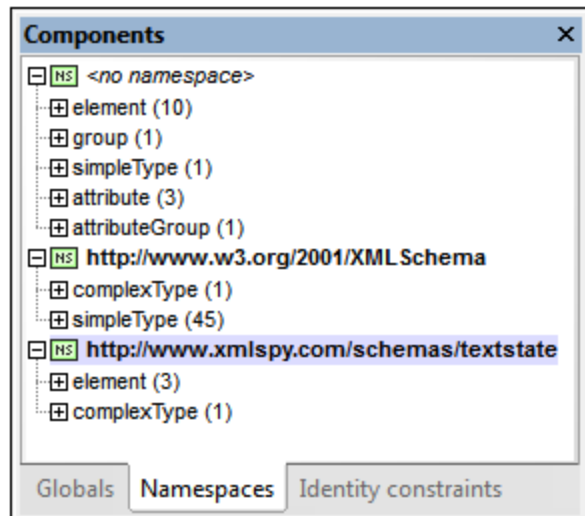

In the tree display, global components are organized into the following seven groups. Note that a component type is listed in a tree only if at least one component of that type exists in the schema.

- Element Declarations (Elements)
- Model Groups (Groups)
- Complex Types
- Simple Types
- Attribute Declarations (Attributes)
- Attribute Groups
- Notations

Component-type groups in the Globals and Namespaces tabs

Expanding a component-type group in the Globals tab or Namespaces tab displays all the components in that group (see *screenshot below*). This enables you to easily navigate to a user-defined component. When you double-click the component in the Components tab, its definition is displayed in the main window.

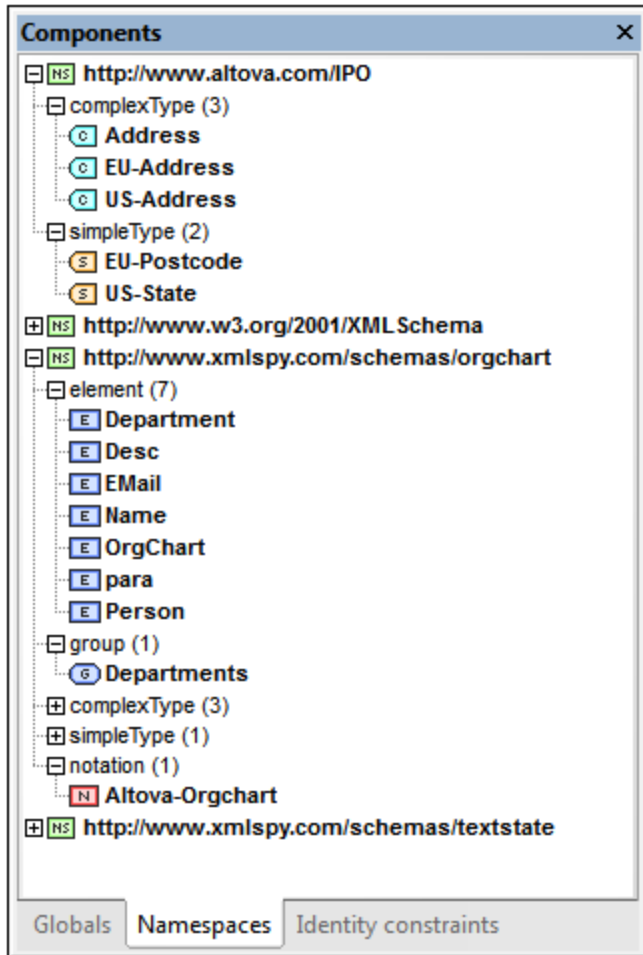

If a component has a content model (that is, if it is an Element, Group, or Complex Type), double-clicking it will cause the component's content model to be displayed in Content Model View (in the Main Window). If the component does not have a content model (i.e. if it is a Simple Type, Attribute, Attribute Group, or Notation), then the component is highlighted in Schema Overview (in the Main Window).

Note: If the component is in an included or imported schema, then the included/imported schema is opened (if it is not already open), and either the component's content model is displayed in Content Model View or the component is highlighted in Schema Overview.

Identity constraints

The Identity Constraints tab of the Components entry helper (*screenshot below*) provides an overview of a document's identity constraints. In this tab, identity constraints are listed by the kind of identity constraint (unique, key, keyref) and displayed as an expandable/collapsible tree.

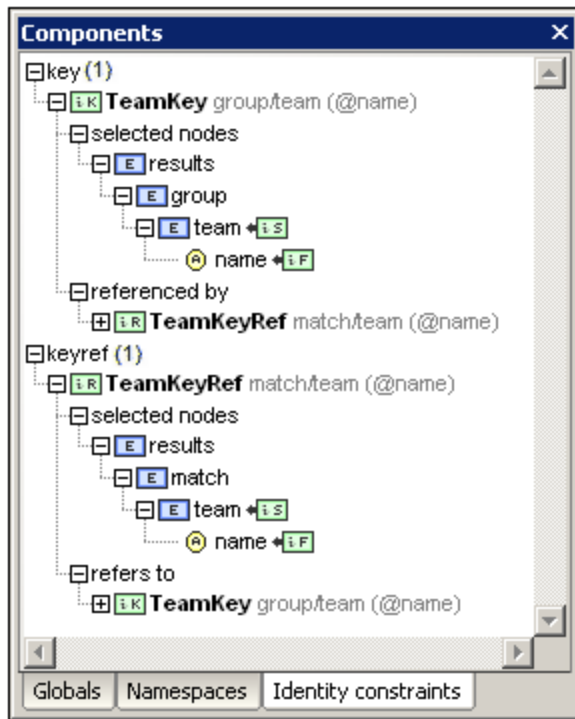

Entries in bold are present in the current schema, while those in normal face are present in sub-schemas. Double-clicking an entry in the Identity Constraints tab selects that schema component in [Content Model View](#)²¹⁶.

The following context menu commands are available when an item in the Identity Constraints tab is selected:

- *Show in Diagram*: selects the schema component in [Content Model View](#)²¹⁶.
- *Show Selector/Field Target in Diagram*: selects, in [Content Model View](#)²¹⁶, the schema component targeted by the selector or field of the identity constraint. In the case of multiple fields, a dialog prompts the user for the required field.
- *Go to Identity Constraint*: selects the identity constraint in [Schema Overview](#)²⁰⁴.
- *Expand/Collapse All*: expands or collapses the tree, respectively.

For a description of the Identity Constraints tab, see the section, [Identity Constraints](#)²⁴⁵.

4.4.5.2 Details

The Details entry helper of Schema View displays editable information about the component or compositor currently selected in the Main Window. If you are editing a schema file which contains database extensions, an additional tab with information about the DB extensions may be visible.

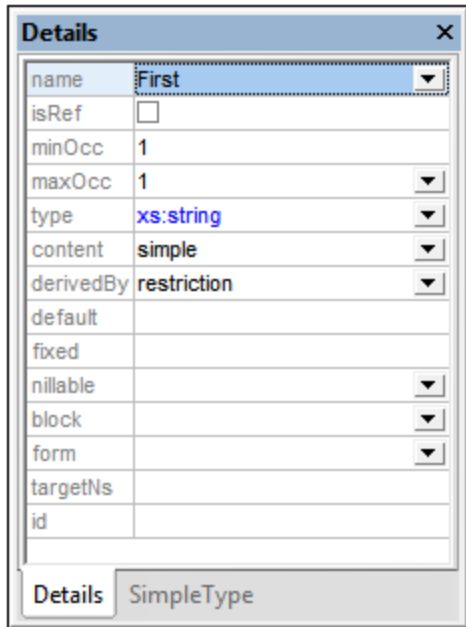

To change the properties of the currently selected component or compositor, double-click the field to be edited and edit or enter text directly. If a combo box is available in the field to be edited, select the desired value from the dropdown list. Changes you make via the Details entry helper are immediately reflected in the design.

Simple type derivations

You can use the Details entry helper to quickly and accurately create derived simple types: *restriction*, *list*, and *union*. When a simple type is selected in the design, the Details entry helper will have a Simple Type tab in it (see screenshot below).

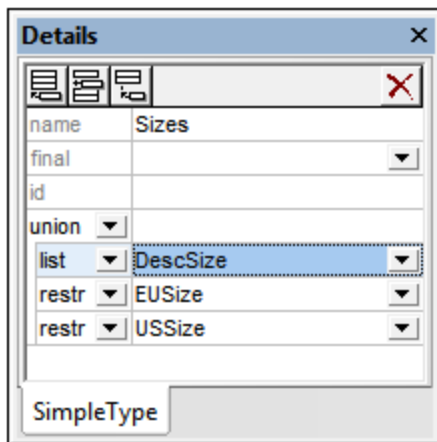

In the derivation-type combo box of the SimpleType tab, select the derivation type (*restriction*, *list*, or *union*) and, in the corresponding member type combo box to its right, select a simple type from the available simple types. Use the icons in the toolbar to append or insert a type on the same level, to add another derivation sub-level, or to delete a derivation type. To go a type's definition, right-click it and select **Go to Type**

Definition. In the case of built-in simple types, a message box appears that contains information about the simple type.

4.4.5.3 Facets

A new simple type (named or anonymous) is created by restricting the simple type's base type (which is an existing simple type). Such a restriction is effected by adding facets to restrict the values of the base type. In Schema View, the Facets entry helper (see *screenshots below*) enables you to graphically and easily edit the facets of a simple type. The available facets are organized in tabs of the Facets entry helper as listed in the table below.

Tab	Available facets
Facets ²⁵⁸	<code>minInclusive</code> , <code>maxInclusive</code> , <code>minExclusive</code> , <code>maxExclusive</code> , <code>length</code> , <code>minLength</code> , <code>maxLength</code> , <code>totalDigits</code> , <code>fractionDigits</code> , <code>whiteSpace</code> , <code>explicitTimezone</code>
Patterns ²⁵⁹	<code>pattern</code>
Enumerations ²⁶⁰	<code>enumeration</code>
Assertions ²⁶⁰	<code>assertion</code>
Samples ²⁶²	<code>altova:exampleValues</code> is an annotation, not a facet . This annotation is used to generate sample values in the instance XML document generated by XMLSpy from the XML Schema.

Each of these tabs is described in the sections below.

Selecting the simple type in the design

A simple type (named or anonymous) can be selected in the following design environments:

- In [Schema Overview](#) ²⁰⁴ (either in the global components list or in the Attributes tab below the global components list), or
- In [Content Model View](#) ²¹⁶ (either in the diagram or in the Attributes tab below the diagram).

When a simple type is selected in the design in any of the design environments listed above, applicable facets in the Facets entry helper become enabled and can be edited in the Facets entry helper.

Facets tab

In the Facets tab, only facets applicable to the type selected in the design will be displayed. For example, if it is the `xs:string` type that is being restricted, then non-applicable facets like `totalDigits` will not be displayed.

- The four bounds facets (`minInclusive`, `maxInclusive`, `minExclusive`, `maxExclusive`) are applicable only to the numeric and date/time types and to types derived from these types.

- The three length facets (`length`, `minLength`, `maxLength`) are applicable only to string-based types, the binary types, and `anyURI`.
- The `totalDigits` facet apply to `xs:decimal` and integer types, and to any types derived from them. The `fractionDigits` facet can be applied only to `xs:decimal`.

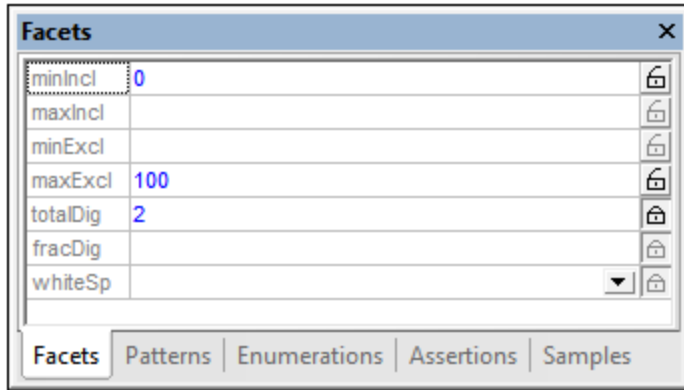

To enter a value, either select a value from the dropdown list of a combo box (if present) or double-click in the value field and enter a value. If an invalid value is entered, the resulting conflicts are displayed in red. Valid values are displayed in blue. For example, a `minInclusive` facet and a `maxInclusive` facet cannot exist together; so if a value is entered for the second of these facets, then the values of both facets are displayed in red.

To specify a **fixed facet** (giving the facet an attribute-value of `fixed="true"`), click the open-lock symbol to the right of the facet so that the symbol becomes a closed-lock. In the screenshot above, the `totalDigits` facet has been set as a fixed facet. More than one facet can be fixed. To unfix a facet, click the closed-lock symbol to make it an open-lock symbol.

Patterns tab

In the Patterns tab (*screenshot below*), you can add one or more `pattern` facets to a restriction. The pattern (of a `pattern` facet) is specified with the regular expression syntax. The pattern in the screenshot below specifies the pattern of email addresses.

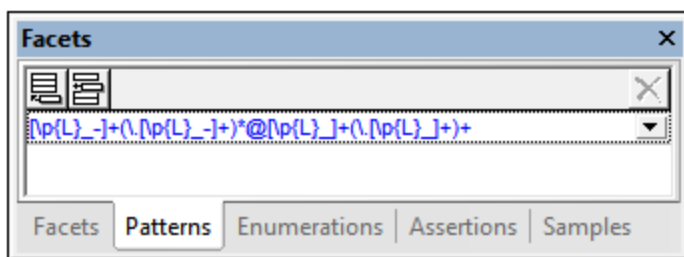

If multiple `pattern` facets are specified, then the XML instance value must match one of the specified patterns. For example, a pattern to restrict postcodes could have two `pattern` facets, one each for US and EU postcodes. An XML instance value must then match one of the patterns for it to be valid.

Add a `pattern` facet by clicking the **Append** or **Insert** icon at top left and then entering a regular expression to define the required pattern. To delete a `pattern`, select it and click the **Delete** icon at top right.

Enumerations tab

In the Enumerations tab (*screenshot below*), you can add one or more `enumeration` facets to a restriction. Each `enumeration` facet specifies a valid value for the type. Taken together, a set of `enumeration` facets specifies a range of allowed values. In the screenshot below, `enumeration` facets specify the allowed range of size values for the restriction.

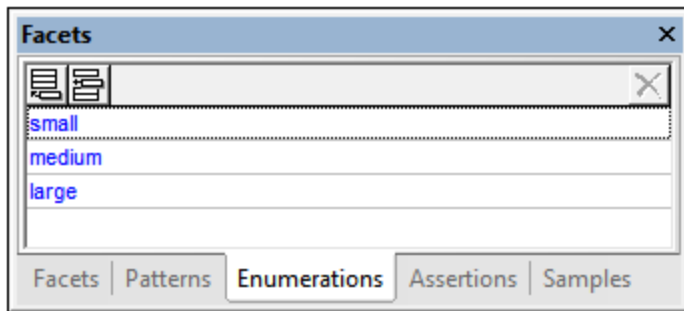

Add an `enumeration` facet by clicking the **Append** or **Insert** icon at top left and then entering the `enumeration` value. To delete an `enumeration`, select it and click the **Delete** icon at top right.

Assertions tab

Assertions are an XSD 1.1 feature. So the Assertions tab will be enabled only in [XSD 1.1 mode](#)²⁰⁰. Assertion facets defined in the Assertions tab of the Facets entry helper are **assertions for simple types**—as opposed to assertions for complex types (which can be [defined and edited](#)²⁴¹ in Schema Overview or Content Model View, **not** in the Facets entry helper).

When a simple type (element or attribute of simple content) is selected in the design, an assertion can be specified for it by switching to the Assertions tab (*see screenshot below*), clicking the **Append** or **Insert** icon at top left, and then entering the XPath 2.0 expression that will be used to define the `assertion`. A special variable called `$value` must be used in the XPath expression to hold the value of the simple type. (Note that, since there are no descendants to test but only a value, the normal `self::node()` path step (or the period abbreviation of this path step '.') cannot be used in the XPath expression.)

For example, the XPath expression `string-length($value) = 6` (*see screenshot below*) tests whether the value of the simple type has six characters. If the element or attribute in the instance document does have six characters, then it is valid according to the assertion.

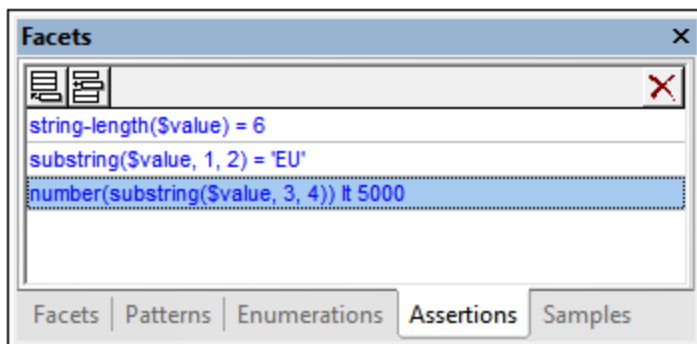

Note: Syntax errors in the XPath expression will be flagged by the expression turning red. But, since the datatype is determined at runtime, type errors will not be flagged when you enter the XPath expression. You must take care to construct types as required. For an example of type construction, see the third XPath expression in the screenshot above, which converts a string value (assuming that the assertion is defined on an `xs:string` simple type) into a number before doing a numeric comparison.

Multiple assertions can be specified on a single simple type, as in the screenshot above. In this case, all the assertions must be satisfied for the element or attribute in the instance document to be valid. The assertions in the screenshot above specify that the instance document value must be a six-character string starting with the characters `EU` and having numeric characters that have a number value of `0000` to `4999` as its final four characters. To edit the details of an assertion, right-click the assertion in the Facets entry helper, and click **Details** in the menu that pops up. This brings up the Assertion Details modal window (see screenshot below).

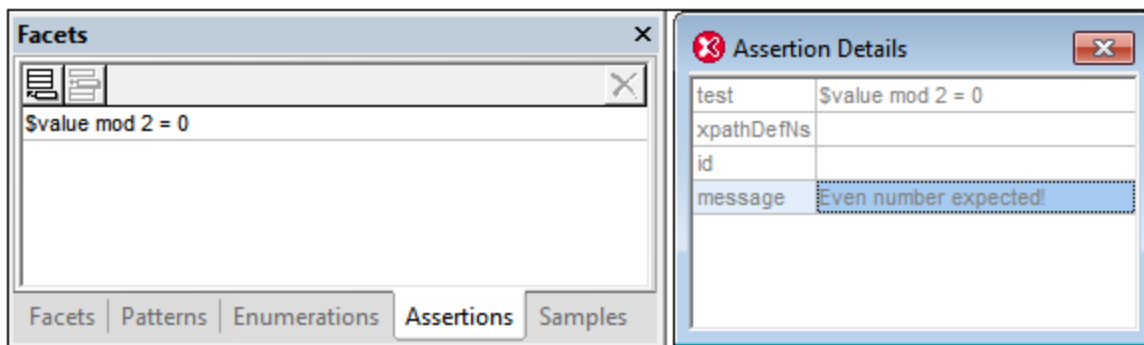

It is very useful if an explanation of the assertion is supplied together with its definition, so that in case the assertion is not fulfilled when the XML instance document is validated, an appropriate message can be displayed. Since the XML Schema specification does not make provision for such a message, XMLSpy allows a message in the Altova `xml-schema-extensions` namespace <http://www.altova.com/xml-schema-extensions> (or any other namespace) to be provided with the definition of the assertion and to be used in the validation of the XML instance document. For example:

```
<xs:assert test="count(//MyNode) ge 1" altova:message="There must be at least one MyNode element"/> OR
<xs:assertion test="count(//MyNode) ge 1" altova:message="There must be at least one MyNode element"/>
```

If the restriction specified in the assertion is not fulfilled, XMLSpy's validation engine will display, along with the validation-error message, the message associated with the assertion as a hint. The validator will report the value of an `assert/@message` attribute or of an `assertion/@message` attribute regardless of the namespace in which the `message` attribute is. However, in Schema View, you can edit only `message` attributes that are in the Altova `xml-schema-extension` namespace. To edit `message` attributes in other namespaces, use Text View.

See [Assertion Messages](#) ²⁶³ for details.

Note: It is a good practice recommendation to use other facets in preference to assertions where possible. For example, the restriction specified by the first assertion in the screenshot above would be better specified by the `length` facet (in the Facets tab).

Samples tab

In the Samples tab (*screenshot below*), you can specify sample values that can be used when generating an XML file from the XML Schema (with the menu command **DTD/Schema | Generate Sample XML File**). If a sample value is invalid, a warning is indicated by displaying the sample value in orange. In the screenshot below, the first value is invalid because it does not match the `pattern` facet specified for emails (see *Patterns tab* above).

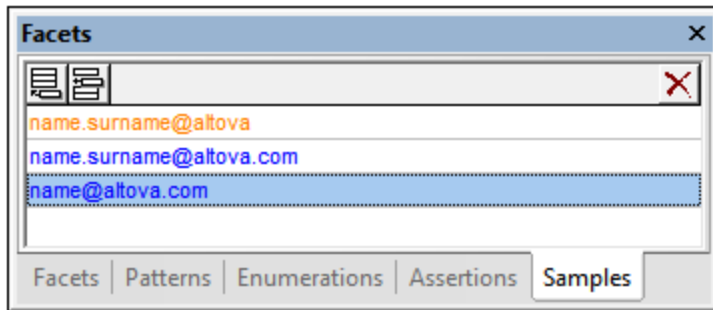

Note: Click the **Display Validation Warnings** icon  in the toolbar to switch on the display of invalid sample-value warnings. An invalid sample value does not invalidate the XSD file if the file is valid in other respects.

Sample values are placed in an `altova:example` annotation element that is in the <http://www.altova.com/xml-schema-extensions> namespace. Add an `altova:example` annotation by clicking the **Append** or **Insert** icon at top left and then entering the `altova:example` value. To delete an `altova:example` annotation, select it and click the **Delete** icon at top right.

4.4.6 Validation and Smart Fixes

An XML Schema document can be validated for correctness. Do this by clicking the menu command **XML | Validate XML (F8)**.

If the document is valid, a message to this effect is displayed in the Messages window.

If the document is invalid, the Messages window will change to display two panes (*see screenshot below*). The left-hand pane (the Errors pane) lists the first `x` errors, or all errors. The right hand pane is the Smart Fix pane; it contains a list of possible fixes for the error selected in the left-hand pane. For example, in the screenshot below, selection of the second error in the Errors pane has caused possible fixes for this error to be listed in the right-hand Smart Fix pane. If you select one of the fixes and then click either **Fix+Validate** or **Fix**, the error in the document is corrected with this particular fix.

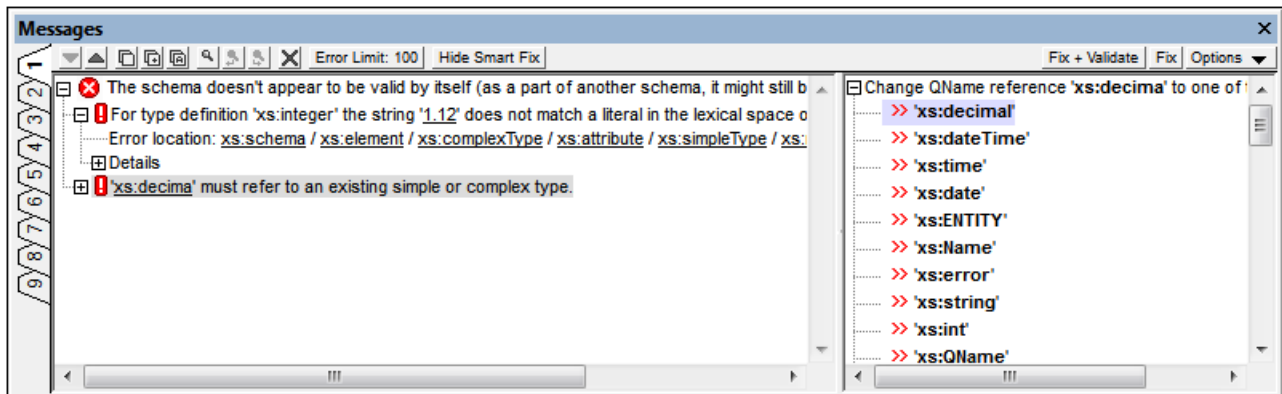

Errors pane

The toolbar of the window provides the following functionality:

- Scroll through the errors using the **Up** and **Down** arrows.
- Copy a message, or a message and its descendants, or all messages to the clipboard.
- Search for words you want using the Find, Find Next, and Find Previous functionality. This is useful if several errors have been reported.
- Clear all errors from the Errors pane.
- Set a limit to the number of found and displayed errors (1 to 999). The default is 100. Click the button to edit the limit.
- Show/Hide Smart Fix pane. When the Smart Fix pane is hidden, the **Show Smart Fix** button appears in the toolbar; clicking it causes the Smart Fix pane to be displayed, and the button changes to **Hide Smart Fix**. If the **Show/Hide Smart Fix** button is disabled, no smart fix is available.

Smart Fix pane

The toolbar of the window provides the following functionality:

- The **Fix+Validate** button corrects the selected error with the selected Smart Fix and re-validates the document. Any other errors will be reported in the Errors pane.
- Clicking the **Fix** button fixes the error but does not re-validate.
- The **Options** button drops down a list containing a choice of behavior on double-clicking a Smart Fix: whether double-clicking carries out a **Fix+Validate** or a **Fix**.

4.4.7 Assertion Messages

In XML Schema 1.1, assertions can be defined for complex types (using `xs:assert` elements) and simple types (using `xs:assertion` elements).

It is very useful if an explanation of the assertion is supplied together with its definition, so that in case the assertion is not fulfilled when the XML instance document is validated, an appropriate message can be displayed. Since the XML Schema specification does not make provision for such a message, XMLSpy allows a message in the Altova xml-schema-extensions namespace <http://www.altova.com/xml-schema-extensions>

extensions (or any other namespace) to be provided with the definition of the assertion and to be used in the validation of the XML instance document. For example:

```
<xs:assert test="count(//MyNode) ge 1" altova:message="There must be at least one MyNode element"/> OR
<xs:assertion test="count(//MyNode) ge 1" altova:message="There must be at least one MyNode element"/>
```

If the restriction specified in the assertion is not fulfilled, XMLSpy's validation engine will display, along with the validation-error message, the message associated with the assertion as a hint. The validator will report the value of an `assert/@message` attribute or of an `assertion/@message` attribute regardless of the namespace in which the `message` attribute is. However, in Schema View, you can edit only `message` attributes that are in the Altova `xml-schema-extension` namespace. To edit `message` attributes in other namespaces, use Text View.

Editing xs:assert messages

In Schema View, `xs:assert` elements (for complex types) can be created and edited in the [Attributes/Assertions/Identity Constraints \(AAIDC\) pane](#)²⁴¹ or [Details entry helper](#)²⁴¹ of the relevant complex type. The screenshot below shows an assertion for the complex type `orderType`. The assertion (an `xs:assert` in this case) is defined in the Assertions tab (of Schema Overview) together with an assertion message.

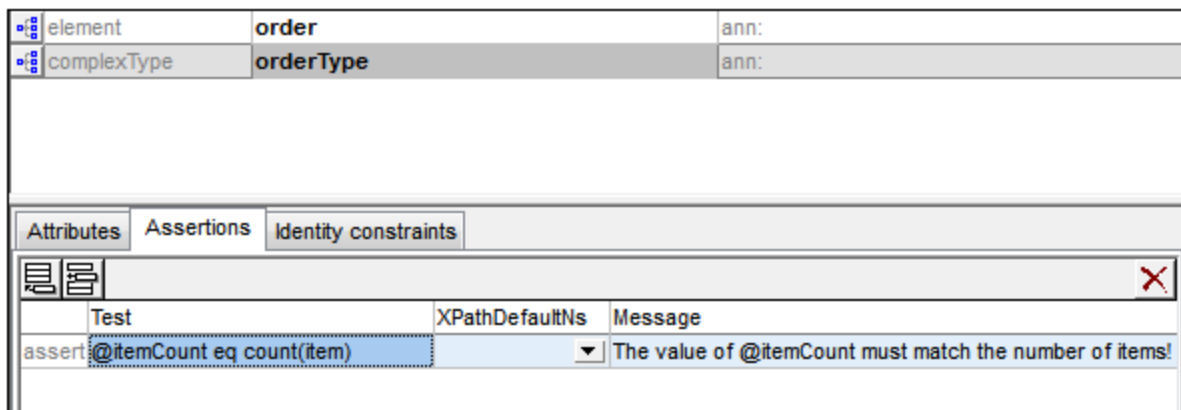

If the [Display Assertions in Diagram](#)²²² option is selected, assertions on complex types can also be created and edited in Content Model View. To add or edit an assertion message, select the assertion and enter the assertion message in the Details entry helper (see screenshot below).

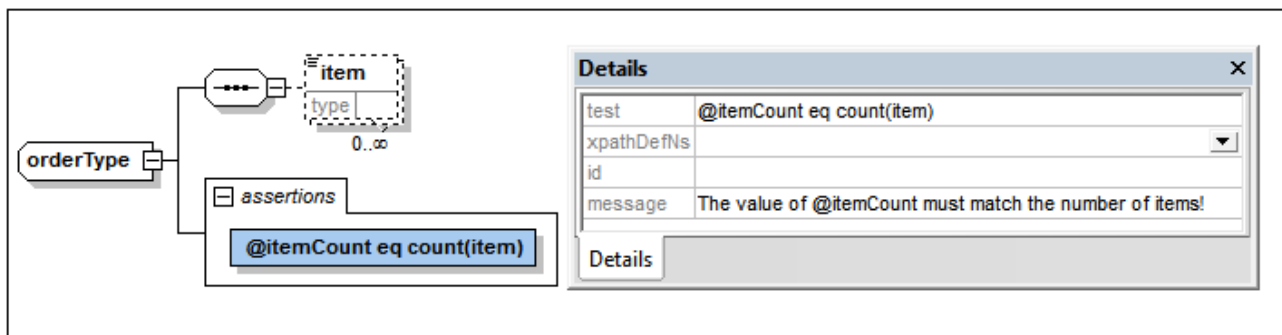

Note that assertion messages created in this way are in the Altova xml-schema-extensions namespace <http://www.altova.com/xml-schema-extensions>. When you add the first assertion message in the XML schema document via the [AAIDC pane](#)²⁴¹ or [Details entry helper](#)²⁴¹, the Altova xml-schema-extensions namespace is automatically declared on the `xs:schema` element.

If an XML file is validated and the assertion test is not fulfilled, the message defined for the assertion is displayed together with an error message (see *screenshot below*).

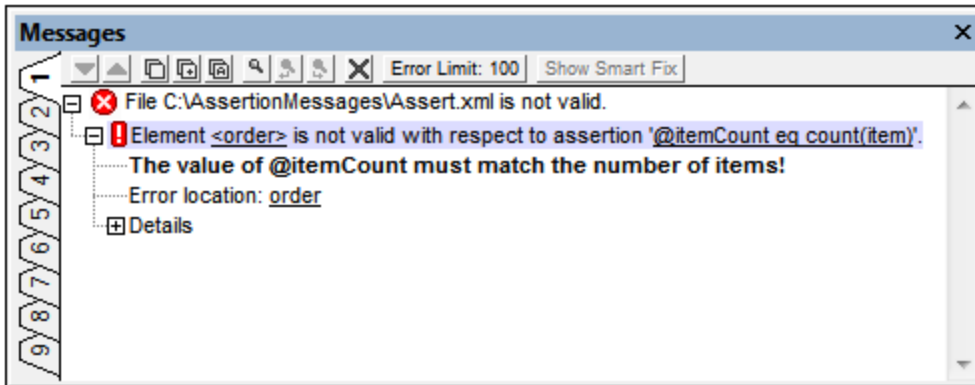

Editing xs:assertion messages

In Schema View, `xs:assertion` elements (for simple types) can be created and edited in the [Facets entry helper](#)²⁵⁸ of the relevant simple type. To edit the assertion message, right-click the assertion in the Facets entry helper (see *screenshot below*), click **Details** in the menu that pops up, and edit the message in the Assertion Details modal window (see *screenshot below*). Note that assertion messages created in this way are in the Altova xml-schema-extensions namespace <http://www.altova.com/xml-schema-extensions>. When you add the first assertion message in the XML schema document via the Assertion Details modal window, the namespace is automatically declared on the `xs:schema` element.

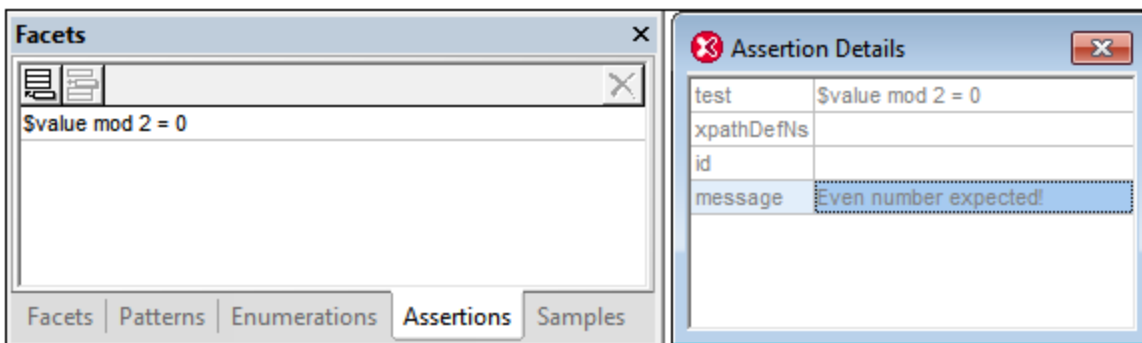

If an XML file is validated and the assertion test is not fulfilled, the message defined for the assertion is displayed together in the error message (see *screenshot below*).

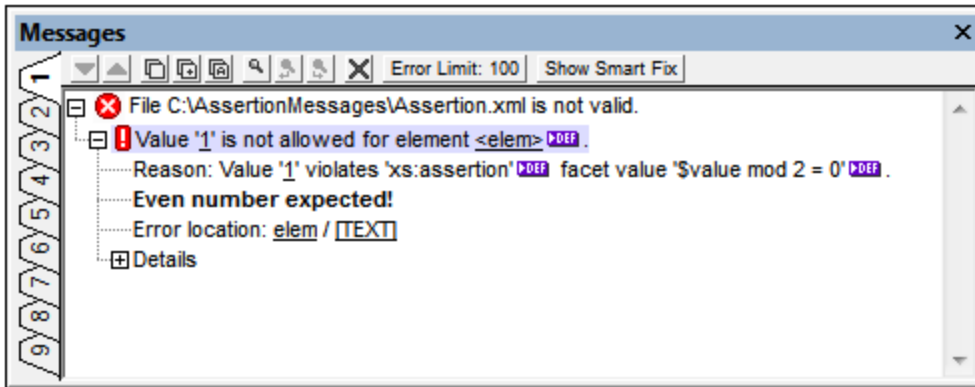

4.4.8 Base Type Modification

If the base type of a derived type is changed in Schema View, content, attributes, facets and sample values defined within the derived type can be handled in one of two ways:

- They can be preserved if they are still applicable in combination with the new base type.
- They can be removed automatically whether or not they are still applicable in combination with the new base type.

When changing the base type of a derived type which contains content, attributes, facets or sample values the Base Type Modification dialog (*screenshot below*) is displayed.

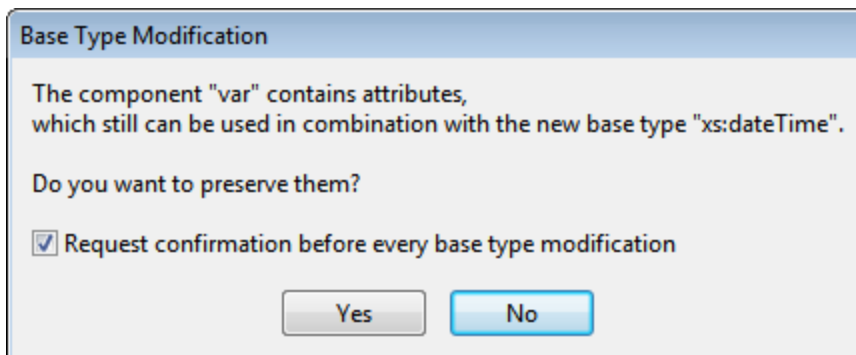

If the *Request Confirmation* check box is de-selected a pop-up (*screenshot below*) indicates that the confirmation can be turned on again in the View section of the Options dialog ([Tools | Options | View](#)¹⁰⁵⁵).

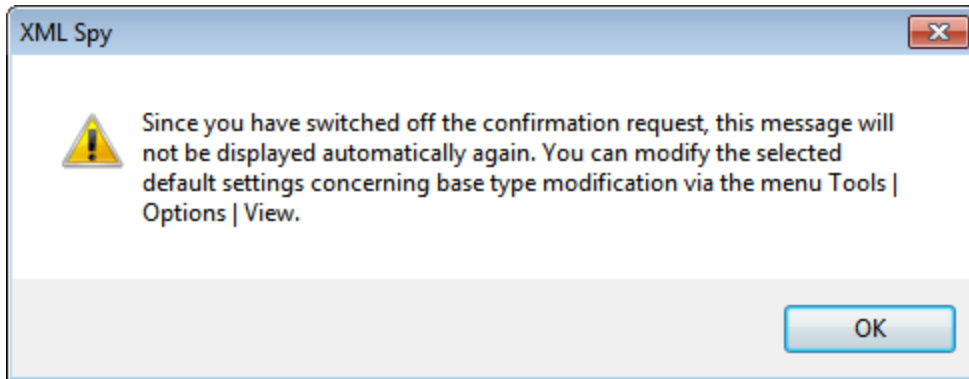

In the Schema View pane (*screenshot below*) of the View section of the Options dialog ([Tools | Options | View](#) ⁽¹⁰⁵⁵⁾), you can specify whether content should be preserved and whether user confirmation is required for every base type modification.

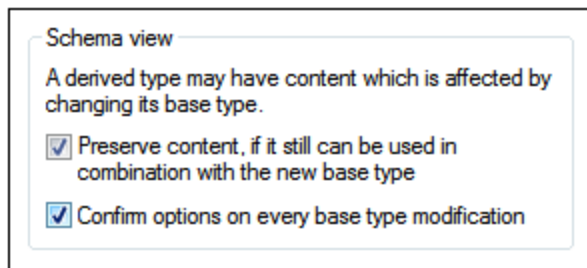

Check the respective check boxes to preserve content and require confirmation if you wish these to be the default options.

4.4.9 Smart Restrictions

When restricting a complex type, parts of the content model of the base type are rewritten in the derived type. This can be confusing if the content model is complex because while editing the derived type it might be hard to correctly remember exactly what the content model of the base type looks like.

Smart Restrictions combine and correlate the two content models in the graphical view of the derived content model. In the derived complex type, all particles of the base complex type, and how they relate to the derived type, can be seen. Additionally, Smart Restrictions provide visual hints to show you all possible ways to restrict the base type. This makes it easy to correctly restrict the derived type.

To switch on Smart Restrictions:

- Click the Smart Restrictions icon  in the Schema Design toolbar.

The example that follows illustrates the features of Smart Restrictions.

The following complex type is the base type used in this example:

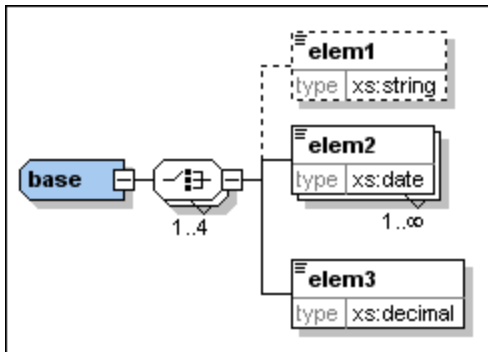

The complex type "derived" is derived from the "base" type as follows:

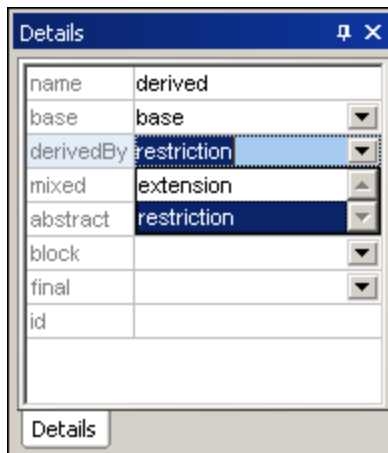

1. Create a new complex type in the schema and call it "derived".
2. In the Details Entry Helper select "base" from the **base** drop-down list and "restriction" from the **derivedBy** drop-down list.



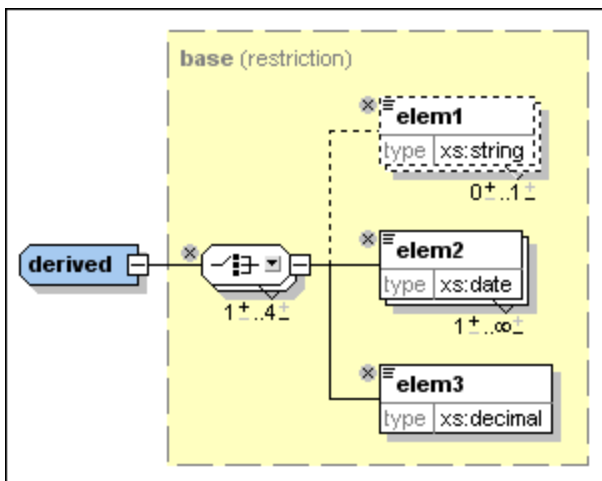

With Smart Restrictions switched on, the new derived type looks like this:

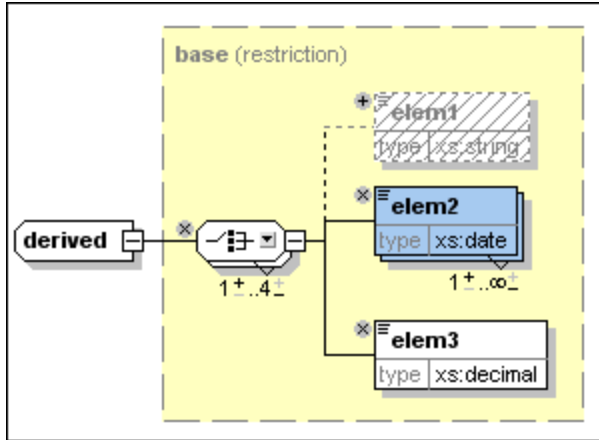

Notice the following controls that can be used to restrict the derived type in this example:

- Use this icon  to remove elements that are in the base type from the derived type. Here, elem1 has been deleted. To add it again, click this icon .



- Click the down arrow on the Choice compositor  to get the following list, which allows you to change the Choice model group to a Sequence model group:

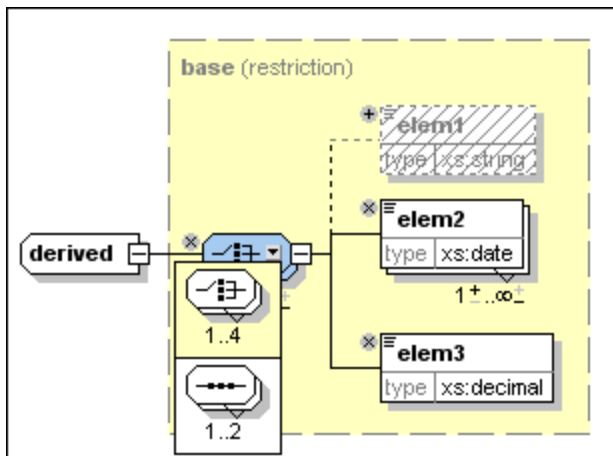

It is also possible to change wildcards in the same way, as seen in this example:

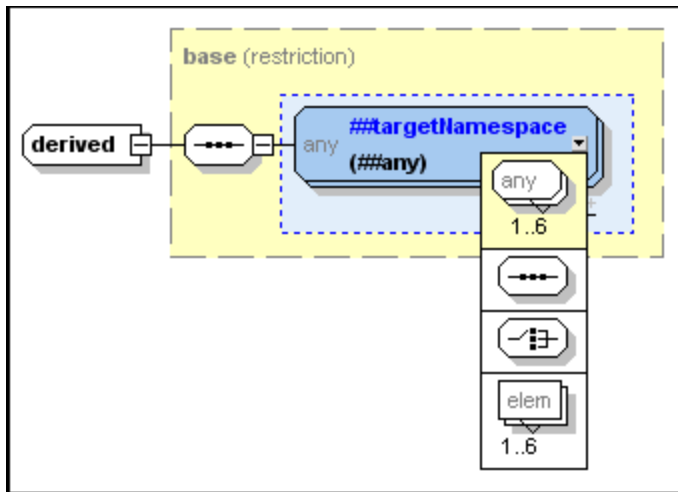

For a complete list of which particles can be replaced by which other particles, see the [XML schema specification](#).

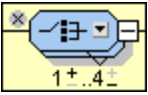
- Change the number of occurrences of the model group using the following control  to increase the minimum number of occurrences by clicking the plus sign over the "1", or to decrease the maximum number of occurrences by clicking the minus sign under "4". These controls are shown if the occurrence range in the base describes a real range (e.g., 2-5) and not a certain amount (e.g. 4-4). They are also displayed if the occurrence range is wrong.

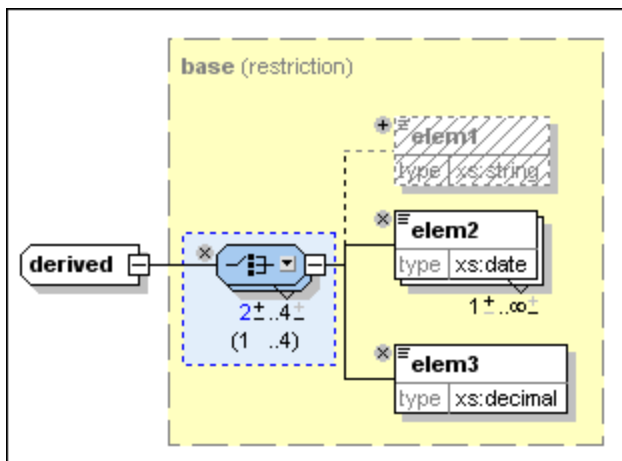

Here you can see that the minimum occurrence for this element has been changed to 2. Notice that the model group now has a blue background, which means that it is no longer the same as the model group in the base complex type. Also, the permitted occurrence range of the model group in the base particle is now displayed in parentheses.

- It is possible to change the data types of attributes or elements if the new data type is a valid restriction of the base data type as defined in the [XML schema specification](#). For example, you can change the data type of elem3 in the "derived" data type from decimal to integer. After you do this, the element has a blue background to show that is different from the element in the base type, and the type that the element has in the base type is displayed in parentheses:

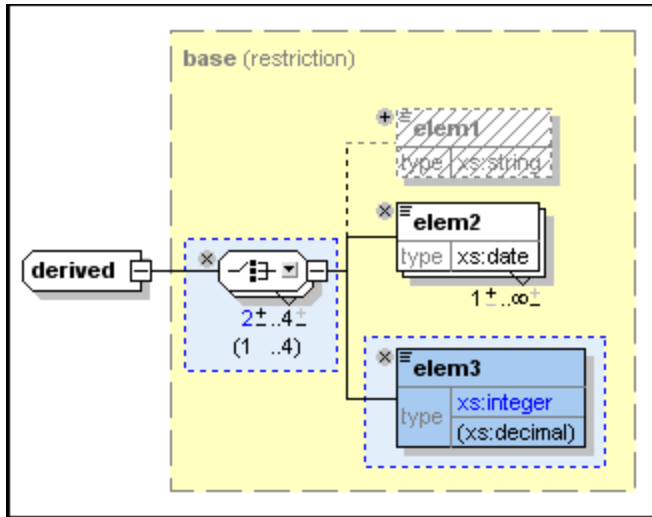

This example shows attributes whose data types have been restricted in the derived complex type:

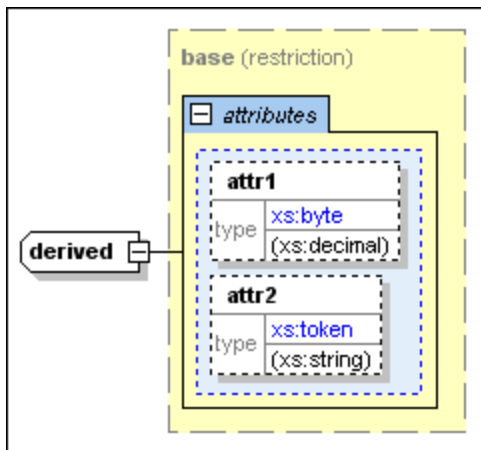

- Smart Restrictions alert you to *pointless occurrences* in the content model. A pointless occurrence happens, for example, when a sequence that is present in the content model is unnecessary. This example shows a pointless occurrence:

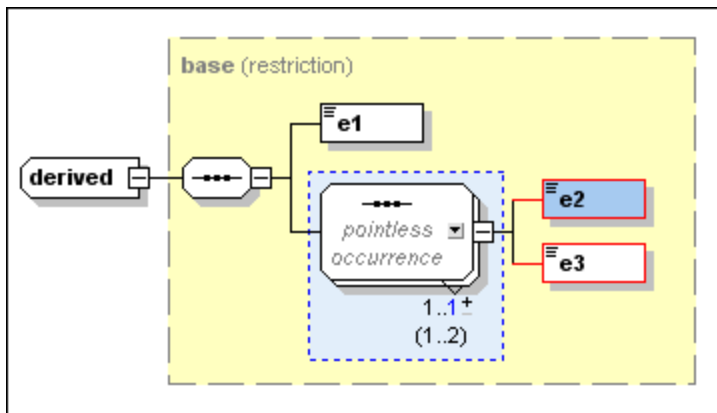

Please note: Pointless occurrences are only shown if the content model contains an error. It is possible for a content model to contain a pointless occurrence and be valid, in which case the pointless occurrence is not explicitly shown in order to avoid confusion.

See the [XML schema specification](#) for more information about pointless occurrences.

4.4.10 xml:base, xml:id, xml:lang, xml:space

The namespace `http://www.w3.org/XML/1998/namespace` is, [according to the XML Namespaces specification](#), bound by definition to the `xml:` prefix. What this means is that this is the namespace that must be used with the `xml:` prefix and that is reserved for it. There are four attributes in this namespace that can be children of any XML element in any XML document (schema or instance):

- `xml:base` (for setting the base URI of an element)
- `xml:id` (for specifying the unique ID of an element)
- `xml:lang` (for identifying the language used within that element)
- `xml:space` (for specifying how whitespace in the element should be handled)

In Schema View, once the XML Namespaces namespace has been imported into the XML Schema document, these four `xml:` attributes can be referenced for use on any element in the schema.

In order to declare one of these attributes on an element, do the following:



1. Declare the XML Namespaces namespace for that schema document and bind the namespace to the `xml:` prefix. When any of the four `xml:` attributes is used in the document, its name would then be expanded to include the correct namespace part.
2. Import the XML Namespaces namespace. XMLSpy's validator will recognize the namespace and make the four `xml:` attributes available as global attributes, which can be referenced within that schema.
3. Insert the required `xml:` attribute as the child of an element. The attribute is declared as a reference to the "imported" global attribute.

Declare the XML Namespaces namespace

You can declare the XML Namespaces namespace (`http://www.w3.org/XML/1998/namespace`) by entering it via the Schema Settings dialog, where all namespaces declared for that schema are stored and can be edited. The namespace must be bound to the `xml:` prefix. (Alternatively, you could declare the namespace (with the `xml:` prefix) on the `xs:schema` element in Text View.)

Import the XML Namespaces namespace

In Schema Overview, create a global import declaration for the XML Namespaces namespace. Do this by

clicking the Insert  or Append  icon at the top of the Schema Overview window and selecting **Import** from the menu that pops up. Enter the XML Namespaces namespace as the namespace to be imported. In Text View, the import declaration should look like this:

```
<xs:import namespace="http://www.w3.org/XML/1998/namespace"
schemaLocation="http://www.w3.org/XML/1998/namespace"/>
```

Adding the xml: attribute

In Schema Overview, select the element for which the `xml:` attribute is to be added, and add an attribute for it. In the Details entry helper (screenshot below), click the down arrow of the name combo box and select the required `xml:` attribute, for example `xml:base`. When you are prompted whether you wish to reference the global attribute, click **Yes**. The attribute is added as a reference.

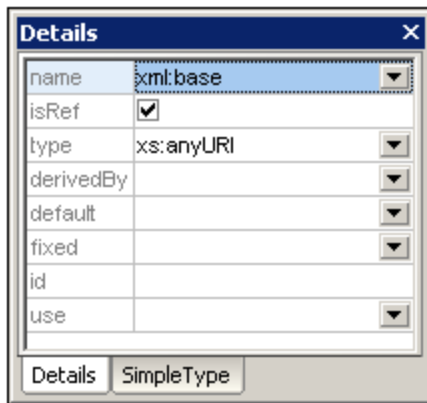



XInclude and xml:base

When XInclude's `include` element is replaced by the XML file specified in the `href` attribute of the include element, the top-level element of the parsed XML document is included with an `xml:base` attribute. If this XML document is going to be validated, then the schema must define an `xml:base` attribute on the relevant element/s.

4.4.11 Back and Forward: Moving through Positions

The **Back** and **Forward** commands in Schema View enable you to move through previously viewed positions in Schema View. This is useful because, while clicking through schema components in Schema View, you might wish to view a previously viewed component. Clicking the **Back** button once in the toolbar takes you to the previously viewed position. By repeatedly clicking the **Back** button, you can view up to 500 of the last visited positions. After moving back through previous positions, you can move forward through these positions by using the **Forward** button in the toolbar.

The shortcut keys for the two commands are:

-  **Back: Alt + Left Arrow**
-  **Forward: Alt + Right Arrow**

Back/Forward versus Undo/Redo

Note that the **Back** and **Forward** commands are not the same as the **Undo (Ctrl+Z)** and **Redo (Ctrl+Y)** commands. These two sets of commands make up two different series of steps. Clicking the **Back** command

once takes you to the previously viewed component as previously displayed. Clicking the **Undo** command once undoes the last editing change regardless of when that editing change was made.

Additional notes

Note the following points:

- The **Back** button enables you to re-view the previous 500 positions.
- The Back/Forward feature is enabled across schemas. If a schema has since been closed or is currently open in another view, it will be opened in Schema View or switched to Schema View, respectively.
- If a component that was viewed in a previous position is deleted, then that component will not be able to be viewed. If such a component was part of a previous position, this position will be displayed without the deleted component. If the component comprised the entire position, the entire position will be unavailable, and clicking the **Back** button at this point in the Back series will take you to the position previous to the unavailable position.

4.5 Authentic View

Authentic View has a menu bar and toolbar running across the top of the window, and three areas that cover the rest of the interface: the Project Window, Main Window, and Entry Helpers Window. These areas are shown below.

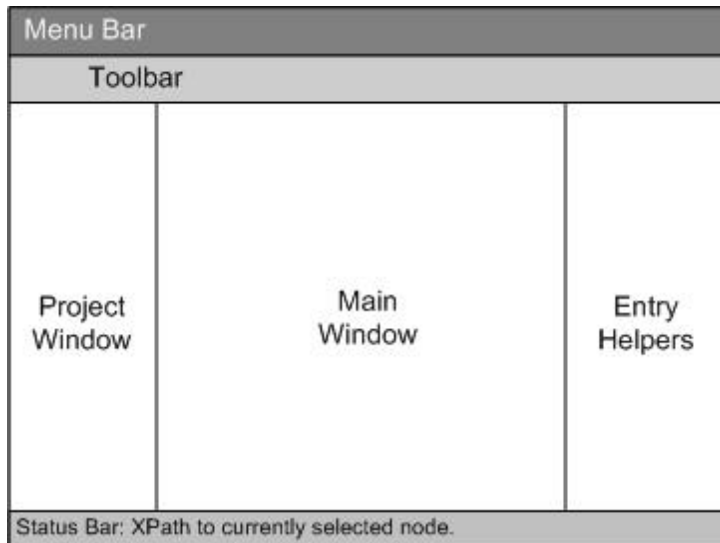

The [Authentic View interface](#)⁴⁵⁹ is described in detail in the section, [Authentic](#)⁴⁴⁴ | [Authentic View Interface](#)⁴⁵⁹.

4.6 Browser View

Browser View is typically used to view:

- XML files that have an associated XSLT file. When you switch to Browser View, the XML file is transformed on the fly using the associated XSLT stylesheet and the result is displayed directly in Browser View.
- HTML files which are either created directly as HTML or created via an XSLT transformation of an XML file.

To view XML and HTML files in Browser View, click the **Browser** tab.

Browser engines in Browser View

By default, Browser View currently uses Microsoft's Internet Explorer as its browser engine. If you wish to use Microsoft's newer Edge WebView2 browser engine for Browser View, you can select this option in the [View section](#)¹⁰⁵⁵ of the [Options dialog](#)¹⁰⁴⁰.

Note: Since Microsoft Edge WebView2 uses the Chromium software project, on which Google's Chrome browser is based, using WebView2 for Browser View also provides a good preview of the Chrome display of a web page.

Notes about Microsoft Internet Explorer

Browser View requires Microsoft's Internet Explorer 5.0 or later, or Microsoft Edge WebView2 (*see above*).

Note the following points about Internet Explorer in Browser View:

- If you wish to use Browser View for viewing XML files transformed by an XSLT stylesheet, we strongly recommend Internet Explorer 6.0 or later, which uses MSXML 3.0, an XML parser that fully supports the XSLT 1.0 standard. You might also wish to install MSXML 4.0.
- Support for XSLT in IE 5 is not 100% compatible with the official XSLT Recommendation. So if you encounter problems in Browser View with IE 5, you should upgrade to IE 6 or later.
- In general, you should check the support for XSLT of your version of Internet Explorer.
- If you encounter problems with the correct display of HTML in Internet Explorer, include the following `meta` tag in the `head` element of your HTML document:

```
<head>
... <meta http-equiv="X-UA-Compatible" content="ie=edge">...
</head>
```

Developer tools in Browser View

You can use the Developer Tools of the underlying browser to inspect, debug, and test your HTML code. To open the tools, right-click in the Browser View pane and select **Open Developer Tools**.

Markdown text and Browser View

If a document in Text View is marked up with [Markdown formatting](#), then switching to Browse View converts the Markdown formatting to simple HTML formatting and renders the document as an HTML page in Browser View.

Browser View features

The following features are available in Browser View. They can be accessed via the **Browser** menu, **File** menu, and **Edit** menu.

- *Open in separate window:* When Browser View is a separate window, it can be positioned side-by-side with an editing view of the same document. To do this, click the menu command **Browser | Separate Window**. This is a toggle command that switches Browser View between two windows: (i) a separate window, and (ii) a tabbed view in the Main Window. These commands are also available in the dropdown menu of the **Browser View** button (at the bottom of the Main Window). In the [View tab](#)¹⁰⁵⁵ of the Options dialog, you can set whether Browser View should be shown by default in a separate window.
- *Forward and Back:* The common browser commands to navigate through pages that were loaded in Browser View. These commands are in the **Browser** menu.
- *Font size:* Can be adjusted via the **Browser** menu.
- *Stop, Refresh, Print:* More standard browser commands, these can be found in the **Browser** and **File** menus.
- *Find:* Enables searches for text strings. This command is in the **Edit** menu.
- *Info Window:* There are options here to view the active HTML page with any of the web browsers installed on the machine and to open or remove the installed browsers.

4.7 Archive View

An [Office Open XML \(OOXML\)](#)⁵⁹⁵ file, [ZIP file](#)⁶⁰¹ (for example, WinZip or WinRAR), or [EPUB file](#)⁶⁰³ can be opened and edited in Archive View. Not only can OOXML, ZIP, and EPUB archives be structurally modified in Archive View, but individual files in the archive can be opened from Archive View, edited in one of XMLSpy's editing views, and then saved directly back to the archive.

Archive files and Archive View

When an archive file (OOXML, ZIP, or EPUB file) is [created or opened in XMLSpy](#)⁵⁹⁷, it is opened in Archive View (*screenshot below*). Multiple archive files can be open at a time, with each archive file being in a separate Archive View window. The type of the archive file appears in the top right-hand corner of Archive View. In the screenshot below, the type of the archive file is MS Office Word Open XML.

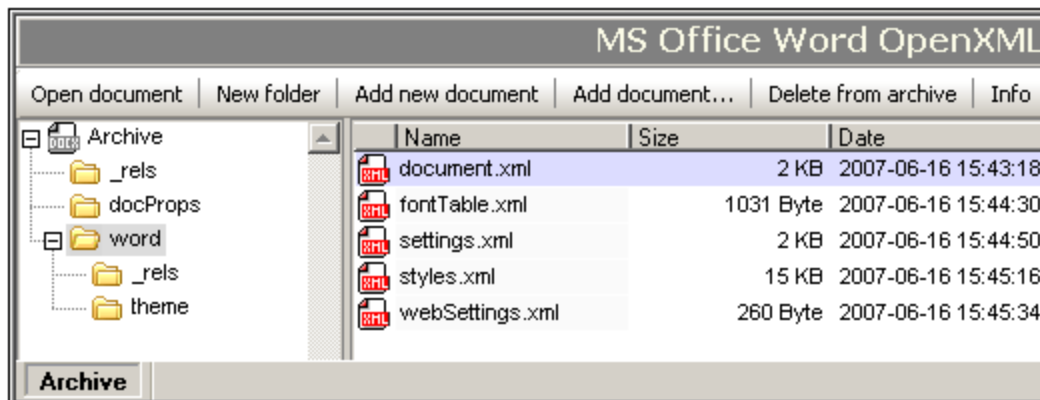

Folder View

The Folder View is located on the left-hand side of the Archive View window and displays the folder structure of the zipped archive. On each level, folders are listed alphabetically. To view the sub-folders of a folder, click the plus symbol to the left of the folder. If a folder does not have a plus symbol to the left of it, then it has no sub-folder. To view the document files (hereafter called documents) contained in a folder, select the folder; the files will be displayed in the Main Window. In the screenshot above, the documents displayed in the Main Window are in the `word` folder, which also has two sub-folders: `_rels` and `theme`.

Main Window

The Main Window lists the documents in the folder that is selected in Folder View. Documents are displayed in alphabetical order, each with its respective uncompressed size and the date and time of last modification. To open a Document from Archive View, double-click it. The document opens in a separate XMLSpy window.

Command buttons

The command buttons are located along the top of the Archive View window.

- **Open document:** Enabled when a document in the Main Window is selected. Clicking it opens the selected document. A document can also be opened by double-clicking the document listing in the Main Window.

- **New folder:** Adds a new folder to the folder that is currently selected in Folder View. The folder must be named immediately upon its being created in Folder View. It is not possible to rename a folder subsequently. The new folder is saved in the archive when the archive file is saved.
- **Add new document:** Adds a new document to the folder currently selected in Folder View. Clicking this button opens the Create New Document dialog of XMLSpy. The newly created document opens in a separate XMLSpy window. The document must be named immediately upon its being listed in the document listing of the selected folder. The document is saved in the archive only when it is saved in its own editing window or when the archive file is saved.
- **Add document:** Opens a Browse dialog in which you can browse for a document to add. The document is added to the listing in the Main Window of documents currently in the selected folder, and the document is opened in a separate XMLSpy window. For the document to be saved to the archive, it must either be saved in its own window, or the archive file must be saved.
- **Delete from archive:** Deletes the selected document (in Main Window) or selected folder (in Folder View) from the archive. The archive file must be saved in order for the deletion to take effect.
- **Info:** Toggles the Info Window on and off. *See below.*

Info Window

The Info Window is toggled on and off by clicking the Info command button. The Info Window provides general information about the archive file, such as the number of files it contains, its uncompressed and compressed sizes, and the compression ratio.

4.8 Common Shortcuts

The default shortcuts of commonly used editing commands are listed below. You can change the default shortcuts in the [Keyboard tab of the Customize dialog](#) ¹⁰²⁷.

Function-key shortcuts (incl. for validation and transformation)

F1	Help Menu
F1 + Alt	Open Last File
F3	Find Next
F4 + CTRL	Close Active Window
F4 + Alt	Close XMLSpy
F5	Refresh
F6 + CTRL	Cycle through Open Windows
F7	Check Well-formedness
F8	Validate
F10	XSL Transformation
F10 + CTRL	XSL:FO Transformation

File and Application commands

Alt + F1	Open Last File
CTRL + O	File Open
CTRL + N	File New
CTRL + P	File Print
CTRL + S	File Save
CTRL + F4	Close Active Window
CTRL + F6	Cycle through Open Windows
CTRL + TAB	Switch between Open Documents
Alt + F4	Close XMLSpy

Miscellaneous keys

Up/Down Arrow Keys	Move Cursor or Selection Bar
Esc	Abandon Edits or Close Dialog Box
Return	Confirm Selection
Del	Delete Character or Selected
Shift + Del	Cut

Editing commands

CTRL + A	Select All
----------	------------

CTRL + F	Find
CTRL + G	Go to Line/Char
CTRL + H	Replace
CTRL + V	Paste
CTRL + X	Cut
CTRL + Y	Redo
CTRL + Z	Undo

5 XML

This section describes how to work with XML documents in XMLSpy. It covers the following aspects:

- [How to create, open, and save XML documents](#)²⁸³. In this section, some important XMLSpy settings relating to file creation are also explained.
- XML documents can be edited in [Text View](#)²⁸⁷, [Grid View](#)²⁹⁰, and [Authentic View](#)²⁹¹. You can select the view that is most useful for you and switch among the views while editing. Each of the views offers different advantages.
- You can easily and quickly [add XML fragments](#)²⁹⁸ to your XML document from external sources.
- How to use the various [XML validation features](#)²⁹⁴ of XMLSpy.
- [Entry helpers](#)²⁹³ for XML documents have certain specific features, and these are described.
- How to [process XML documents with XSLT and XQuery](#)³⁰⁰. Various XMLSpy features related to processing are explained. A section on [PDF Fonts](#)³⁰² explains how fonts are processed when generating PDF output.
- Miscellaneous [other features](#)³⁰⁵ for working with XML documents are described.

Altova website:  [XML Editor](#)

5.1 Creating, Opening, and Saving XML Documents

When creating, opening, or saving XML documents, the following issues are involved:

- In what view will the XML document open: Text View, Grid View, or Authentic View
- When a new XML document is created, whether a schema (XML Schema or DTD) will be automatically assigned, manually assigned, or not assigned
- If a schema is assigned to the XML document, whether the document will be validated automatically on opening and/or saving

Default view

There are application-wide settings for specifying in what view XML documents (new and existing) should open. These settings are in the Options dialog (**Tools | Options**).

In the **File Types** section of the Options dialog, select a file type of `.xml` and, in the Default View pane, check the required editing view (Text or Grid). Note that: (i) Schema View can be used only for XML Schema; and (ii) Browser View is a display view, not an editing view.

In the **File Types** tab, you can also set XMLSpy as the default editor for the selected file type.

An XML document can be edited in Authentic View if a StyleVision Power Stylesheet (SPS) has been assigned to it. When an XML file with an associated SPS is opened, you can specify that it opens directly in Authentic View. Do this by checking the *Always open in Authentic View* option in the **View** section of the Options dialog. If this option is not checked, the file will open in the default view specified for `.xml` files in the **File Types** tab (see above).

Assigning schemas

When a new XML file is to be created, select the menu command **File | New**. This pops up the Create New Document dialog (screenshot below).

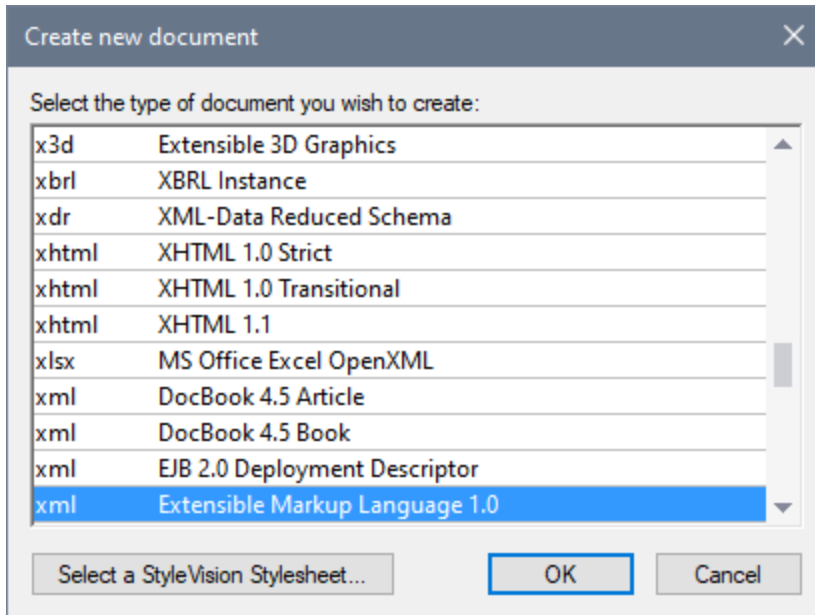

Notice that there are several options for the XML document type. The options marked *Extensible Markup Language* create a generic XML documents. Each of the other options is associated with a schema, for example the DocBook DTD. If you select one of these options, an XML document is created that has (i) the corresponding schema automatically assigned to it, and (ii) a skeleton document structure that is valid according to the assigned schema. Note that you can create your own skeleton XML document. If you save it in the `Template` folder of the application folder, your skeleton document will be available for selection in the Create New Document dialog.

If you select the generic Extensible Markup Language document type, you will be prompted for a schema (DTD or XML Schema) to assign to the document. At this point, you can choose to browse for a schema (or schema package) or go ahead and create an XML document with no schema assigned to it.

You can, of course, assign a schema via the **DTD/Schema** menu at any subsequent time during editing.

Automatic validation

If an existing XML document has a schema assigned to it, then it can be automatically validated on opening and/or saving. The setting for this is in the **File** section of the Options dialog (**Tools | Options**).

The automatic validation settings in the **File** tab can be combined with a setting in the File Types tab to disable automatic validation for specific file types. Using the settings in the two tabs together enables you to specify automatic validation for specific file types.

5.2 Assigning Schemas and Validating

Altova website: [XML Validator](#), [XML Validation](#)

A schema (DTD or XML Schema) can be assigned to an XML document [when it is first created](#)²⁸³. A schema can also be assigned, or changed, at any subsequent time using the **Assign DTD** or **Assign Schema** commands in the **DTD/Schema** menu.

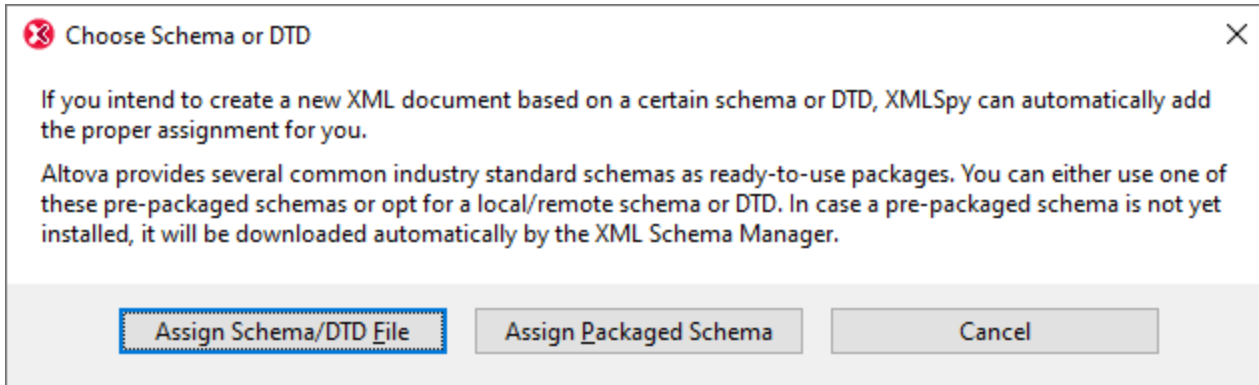

The following options are available:

- *Assign Schema/DTD File*: Browse for the XML Schema or DTD file you want to assign. Note that you can make the assignment in the document a relative or absolute path.
- *Assign Packaged Schema*: Some schemas are each actually a package of schema files rather than a single schema file. The *Assign Packaged Schema* option opens a dialog that lists the schema packages supported by Altova's [Schema Manager](#)³⁰⁷. In this dialog, schemas listed in black have already been installed on your machine, those in blue have not been installed and can be installed by [Schema Manager](#)³⁰⁷. When you select a schema package or one of its schema entry points and click **OK**, the following happens: The schema package will be installed if it has not already been installed. The selected schema package (previously installed or newly installed) will be assigned to the document and will be used from this point onwards for document validation.
- *Cancel*: If a new file is being created, then it is created with no XML Schema or DTD assignment. If the schema assignment is for an already existing document, then the dialog is exited.

Global resources for schemas

A global resource is an alias for a file or folder. The target file or folder can be changed within the GUI by changing the active configuration of the global resource (via the menu command **Tools | Active Configuration**). Global resources therefore enable the assigned schema to be switched among multiple schemas, which can be useful for testing. How to use global resources is described in the section [Altova Global Resources](#)⁶⁹⁶.

XML Schema plus DTD

One very useful DTD feature that XML Schema does not have is the use of entities. However, if you wish to use entities in your XML-Schema-validated XML document, you can add a `DOCTYPE` declaration to the XML document and include your entity declarations in it.

```
<?xml version="1.0" encoding="UTF-8"?>
```

```
<!DOCTYPE OrgChart [  
  <!ENTITY name-int "value">  
  <!ENTITY name-ext SYSTEM "extfile.xml">  
>  
<OrgChart xmlns="http://www.xs.com/org"  
  xsi:schemaLocation="http://www.xs.com/org OrgChart.xsd">  
  ...  
</OrgChart>
```

After declaring the entities in the DTD, they can be used in the XML document. The document will be well-formed and valid. Note, however, that external parsed entities are not supported in Authentic View..

Going to schema definitions

With the XML document open, you can directly open the DTD or XML Schema on which it is based by clicking the Go to DTD or Go to Schema commands in the **DTD/Schema** menu. Additionally, you can place the cursor within a node in the XML document and go to the schema definition of that node via the **Go to Definition** command in the **DTD/Schema** menu.

Validating and checking well-formedness

To validate and/or check for well-formedness, use the [Validate XML \(F8\)](#) and **Check Well-Formedness (F7)** commands in the XML menu or the corresponding commands in the toolbar. Any error is reported in the Messages window. If an XML document is invalid, the XML validator provides [smart fixes to correct the error](#)⁸⁵⁷ based on the information in the schema.

You can also use a [RaptorXML Server](#)⁷²¹ to validate XML documents.

5.3 XML in Text View

XMLSpy offers some specialized XML text editing features (described below) in addition to the generally available editing features in Text View (which are described in [Text View](#)¹³⁰ in the Editing Views section).

- [Commenting text in and out](#)²⁸⁷
- [Note about empty lines](#)²⁸⁷
- [Find and Replace](#)²⁸⁷
- [Escaping and unescaping XML characters](#)²⁸⁸
- [Inserting file paths](#)²⁸⁸
- [Inserting XML fragments via XInclude](#)²⁸⁸
- [Copying XPath and XPointer expressions to the clipboard](#)²⁸⁸
- [Save a Base64-encoded image string as an image](#)²⁸⁸

Commenting text in/out

Text in an XML document can be commented out using the XML start-comment and end-comment delimiters, respectively `<!--` and `-->`. In XMLSpy, these comment delimiters can be easily inserted using the **Edit | Comment In/Out** menu command.

To comment out a block of text, select the text to be commented out and then select the command **Comment In/Out**, either from the **Edit** menu or the context menu that you get on right-clicking the selected text. The commented text will be grayed out (see *screenshot below*).

```
<Department>
  <Name>Administration</Name>
  <Person>
  <Person>
  <Person>
  <!--<Person>
    <First
    <Last></Last>
    <PhoneExt></PhoneExt>
    <EMail></EMail>
    <LeaveTotal></LeaveTotal>
    <LeaveUsed></LeaveUsed>
    <LeaveLeft></LeaveLeft>
  </Person>-->
</Department>
```

To uncomment a commented block of text, select the commented block **excluding** the comment delimiters, and select the command **Comment In/Out**, either from the **Edit** menu or the context menu that you get on right-clicking the selected text. The comment delimiters will be removed and the text will no longer be grayed out.

Note about empty lines

In XML documents, empty lines are discarded when you change views or save the document. If you wish to retain empty lines, enclose them in comment delimiters.

Find and Replace

You can use the **Find**⁸¹² (**Ctrl+F**) and **Replace**⁸¹⁸ (**Ctrl+H**) commands of the **Edit**⁸⁰³ menu to find text in Grid View and replace it. Results are highlighted in orange, and containing cells also highlighted in orange.

Escaping and unescaping XML characters

The five XML special characters (*listed below*) can be escaped and unescaped with the corresponding entity references (*listed below*) by highlighting a block of text and selecting the context menu command **Escape XML Characters** or **Unescape XML Characters**. The XML special characters in that block of text will then be escaped or unescaped according to the command selected.

```
<      &lt;
>      &gt;
&      &amp;
'      &apos;
"      &quot;
```

For example:

```
<a></a> can be escaped with the Escape XML Characters command to &lt;a&gt;&lt;/a&gt; and
&lt;a&gt;&lt;/a&gt; can be unescaped with the Unescape XML Characters command to <a></a>
```

Inserting file paths

The [Edit | Insert File Path](#)⁸⁰⁸ command enables you to browse for the file in question and insert its file path at the selected location in the XML document being edited. This command enables you to quickly and accurately enter a file path. See the [command description](#)⁸⁰⁸ for more details.

Inserting XML fragments via XInclude

The [Edit | Insert XInclude](#)⁸⁰⁸ enables you, via XInclude, to insert the contents of an entire XML document, or a fragment of one, in the XML document being edited. This command enables you to quickly and accurately enter entire XML documents (via the XInclude mechanism) or fragments of XML documents (via an XPointer extension of the XInclude mechanism). See the [command description](#)⁸⁰⁸ for more details.

Copying XPath and XPointer expressions to the clipboard

The XPath and XPointer expressions of the selected node (expressing the node's position in the XML document) can be copied to the clipboard using the [Edit | Copy XPath](#)⁸⁰⁷ and [Edit | Copy XPointer](#)⁸⁰⁷ commands, respectively. This enables you to obtain the correct XPath and XPointer expressions targeting the selected node.

For example, let the selected node in Text View or Grid View be the third `Office` element of a document element called `Offices`. In this case, the copied XPath expression will be `/Offices/Office[3]`. And the copied XPointer expression, if the `Office` elements have no other-named sibling that occurs before the third `Office` element, will be `element(/1/3)`.

The copied expressions can then be inserted at any required location. For example, an XPath expression can be inserted in an XSLT stylesheet and an XPointer expression in the `href` attribute of an `xinclude` element.

For more detailed descriptions of the commands, see their descriptions in the User Reference section.

Save a Base64-encoded string as an image

To save a Base64-encoded string in its image format, right-click the encoding text and select the command **Save as Image**. In the dialog that appears, select the location where you want to save the image and enter a name for the image file. The extension of the image file (.png, .gif, .svg, etc) will be auto-detected from the Base64 encoding and will appear in the Save dialog. Click **Save** when done.

This action can also be carried out via the **Edit | Save as Image** menu command.

5.4 XML in Grid View

[Grid View](#)¹⁴⁶ shows the hierarchical structure of **XML documents** through a set of nested containers that can be expanded and collapsed. This provides a clear picture of the document's structure. In Grid View, document structure can be easily modified and content can be easily edited.

XML		<?xml version="1.0" encoding="UTF-8"?>																							
Company		<ul style="list-style-type: none"> xmlns: http://my-company.com/namespace xmlns:xsi: http://www.w3.org/2001/XMLSchema-instance xsi:schemaLocation: http://my-company.com/namespace AddressLast.xsd 																							
Address		<ul style="list-style-type: none"> xsi:type: US-Address Name: US dependency Street: Noble Ave. City: Dallas Zip: 04812 State: Texas 																							
Person (3)		<table border="1"> <thead> <tr> <th></th> <th>Manager</th> <th>Degree</th> <th>Programmer</th> <th>First</th> </tr> </thead> <tbody> <tr> <td>1</td> <td>false</td> <td>MA</td> <td>true</td> <td>Alfred</td> </tr> <tr> <td>2</td> <td>true</td> <td>Ph.D</td> <td>false</td> <td>Colin</td> </tr> <tr> <td>3</td> <td>true</td> <td>BA</td> <td>false</td> <td>Fred</td> </tr> </tbody> </table>					Manager	Degree	Programmer	First	1	false	MA	true	Alfred	2	true	Ph.D	false	Colin	3	true	BA	false	Fred
	Manager	Degree	Programmer	First																					
1	false	MA	true	Alfred																					
2	true	Ph.D	false	Colin																					
3	true	BA	false	Fred																					

In the screenshot above, notice that the document is displayed as a hierarchy in a grid form. When a node can contain content, it either directly contains content (as in the case of *Text* nodes) or it is divided into two fields: node name and node content (as in the case of *Element* nodes). Node names are displayed in bold face and node content in normal face.

Furthermore, if an element is repeated (such as the `Person` child elements of a `Company` element), then instead of each `Person` element repeating one below the other, they can be displayed in a table format, where the child elements of `Person` are displayed as columns of the table and each `Person` element is represented in a numbered row (see the table at bottom in the screenshot, which shows three `Person` elements).

Grid View provides you with other powerful features for displaying your XML document in graphical form (such as a split view, filters, and charts), as well as editing features such as drag-and-drop and the ability to create formulas that generate new data.

For a full description of Grid View features, see the [Editing Views | Grid View section](#)¹⁴⁶.

5.5 XML in Authentic View

Authentic View enables a user to edit an XML document as if it were a text document (*screenshot below*). The XML markup and all other non-content text can be hidden from the person editing the document. This can be useful for people who are unfamiliar with XML, enabling them to creating valid XML documents even while concentrating on the content of the document.

Location: US	
Street: 119 Oakstreet, Suite 4876	Phone: +1 (321) 555 5155 0
City: Vereno	Fax: +1 (321) 555 5155 4
State & Zip: DC <input type="text" value="29213"/>	E-mail: office@nanonull.com

Vereno Office Summary: 4 departments, 15 employees.

The company was established **in Vereno in 1995** as a privately held software company. Since 1996, Nanonull has been actively involved in developing nanoelectronic software technologies. It released the first version of its acclaimed *NanoSoft Development Suite* in February 1999. Also in 1999, Nanonull increased its capital base with investment from a consortium of private investment firms. The company has been expanding rapidly ever since.

Due to the fact that nanoelectronic software components are new and that sales are restricted to corporate customers, Nanonull and its product line have not received much media publicity in the company's early years. This has however changed in recent months as trade journals have realized the importance of this revolutionary technology.

The Authentic View of a document is enabled when a StyleVision Power Stylesheet (SPS) is assigned to an XML document. An SPS is based on the same schema source as that on which the XML document is based, and it defines the structure of the XML document. The SPS also defines the layout and formatting of the document in Authentic View. For example, in the document shown in the screenshot above, the following Authentic formatting and editing features are used:

- Paragraph and other block formatting
- Table structures
- Text formatting, such as color and font face
- Combo boxes (see the State and Zip fields) enable the user to select from a group of valid choices, which can be taken from schema enumerations, as has been done in the case above
- Additional information can be calculated from the data in the document and be presented (in the example above, the office summary details have not been entered by the user but calculated from other data in the document)

SPSs are created specifically for viewing and editing XML documents in Authentic View and for generating standard output (such as HTML, PDF, RTF, and Word 2007 documents) from XML. SPSs are created with Altova StyleVision.

Editing document structure

Valid nodes can be added to the document at any time by selecting a location and then adding the required node via the entry helpers (Elements and Attributes) or context menu. The nodes available at any given location are restricted to the nodes that can be validly added as siblings or children at the selected location. For example, when the cursor is located within a paragraph, you can append another paragraph if this is allowed by the schema.

When editing the structure of an XML document in Authentic View, it could be useful to see the markup of the document. Markup can therefore be switched on as tags (*screenshot below*) using the **Authentic | Show Large Markup** command (or the corresponding toolbar icon).

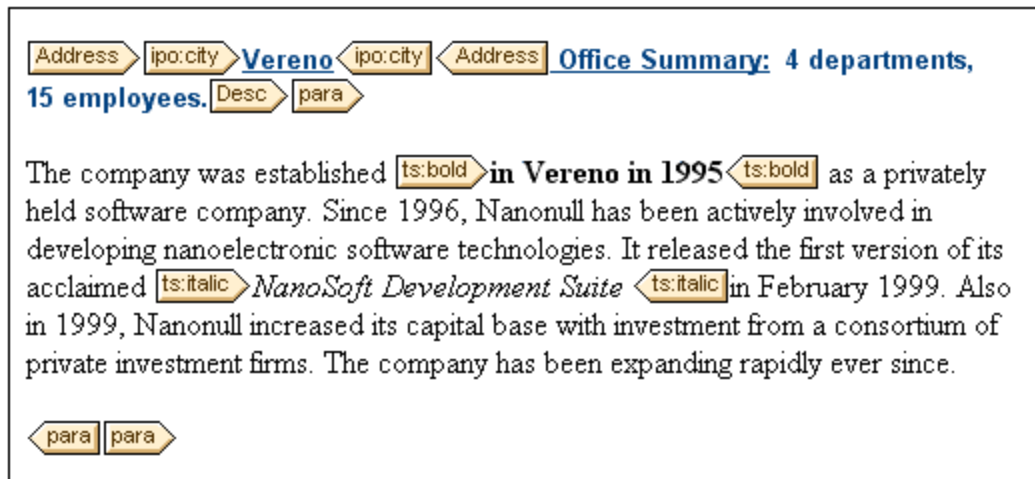

Editing content

Content is created and edited by typing it into the nodes of the document. Entities and CDATA sections can be added via the context menu (entities also via the Entities entry helper).

More about editing in Authentic View

For more details of how to edit in Authentic View, see the Authentic View section.

5.6 Entry Helpers (Text View, Authentic View)

For XML documents in Text View and Authentic View, there are three entry helpers: Elements, Attributes, and Entities. When an element is added via the Elements entry helper, it can be added together with mandatory child elements, mandatory attributes, all child elements, or no child element or attribute, according to the respective settings in the [Editing section of the Options dialog](#)¹⁰⁴⁷. When empty attributes are added, they are added with quotes.

Note that in the different views, the entry helpers are designed differently, in accordance with the functionality of the respective view.

Elements entry helper

The following points should be noted:

- *Text View:* Elements are inserted at the cursor insertion point. Unused elements are displayed in red, used elements in gray. Mandatory elements are indicated with an exclamation mark "!" before the name of the element.
- *Authentic View:* Elements can be inserted before, after, or within the selected element. Additionally, there is a document tree that shows the location of the currently selected element in the document's tree structure. For more details of how to edit in Authentic View, see the Authentic View section.

Attributes entry helper

The following points should be noted:

- *Text View:* When the cursor is placed inside the start tag of an element and after a space, the attributes declared for that element become visible. Unused attributes are displayed in red, used attributes in gray. Mandatory attributes are indicated with an exclamation mark "!" before the name of the attribute.

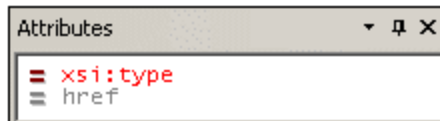

- To insert an attribute, double-click the required attribute. The attribute is inserted at the cursor point together with an equals-to sign and quotes to delimit the attribute value. The cursor is placed between the quotes, so you can start typing in the attribute value directly.
- *Authentic View:* When an element is selected, the attributes declared for that element become visible. Enter the value of the attribute in the entry helper.

Entities entry helper

Any parsed or unparsed entity that is declared inline (within the XML document) or in an external DTD, is displayed in the Entities entry helper. In all three views (Text, Grid, and Authentic), an entity is inserted at the cursor insertion point by double-clicking it. In Grid View, entities are displayed in the Append, Insert, and Add Child tabs.

Note that if you add an internal entity, you will need to save and reopen your document before the entity appears in the Entities entry helper.

5.7 Validating XML Documents

The **XML | Validate (F8)** command validates an XML document against an associated DTD, XML Schema, or other schema. If a document is valid, a successful-validation message is displayed in the Messages window. Otherwise, the causes of the error are displayed in the left-hand pane (see *screenshot below*). If a cause is selected in the left-hand pane, then smart fixes for it, if available, are displayed in the right-hand pane. Smart fix suggestions are based on information in the associated schema. To apply a smart fix, either (i) double-click it, or (ii) select it and click either the **Fix** or **Fix + Validate** options (see *screenshot below*).

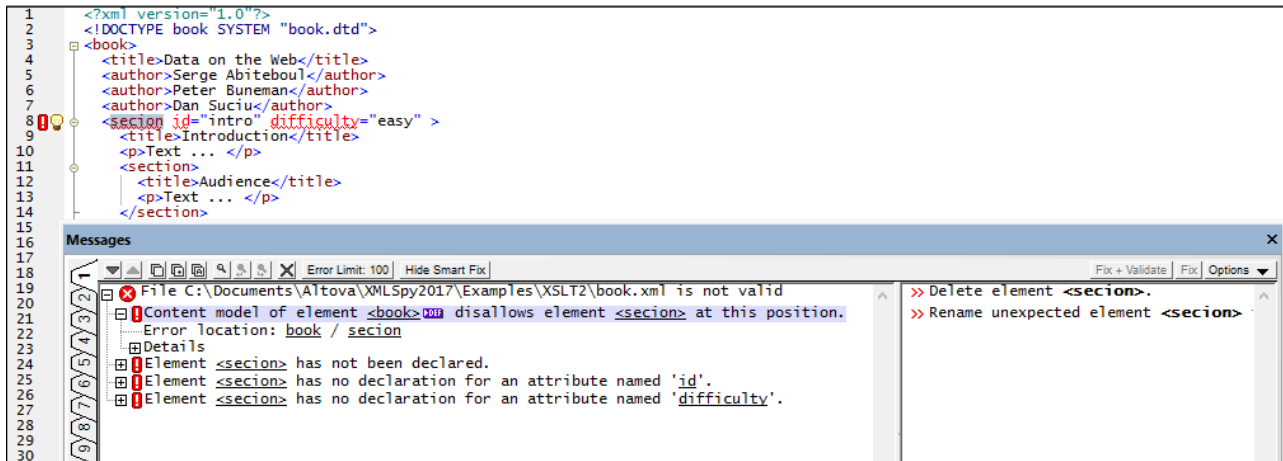

Error indicators and smart fixes

Error indicators

In Text View, there are two additional indicators of a validation error (see *screenshot below*): (i) a red exclamation-mark icon in the line-numbering margin, and (ii) a red marker-square in the scroll bar (on the right of the window).

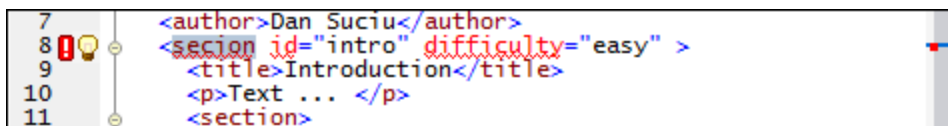

Note that the red marker-square appears on the left-hand side of the scroll bar (located at the right-hand side of the window; see *screenshot above*). This is mentioned because here because scroll bar displays two other kinds of marker-squares: (i) for highlighted text occurrences (brown, left-hand side of the scroll bar; see [Navigating the Document](#)¹³⁹); (ii) Find occurrences (brown, right-hand-side of the scroll bar; see [the Find](#)⁸¹² command).

Smart fixes

If a smart fix is available for an error, then a light bulb icon is shown on the line that generates the error (see *screenshot below*). When you place the mouse over icon, a popup appears that lists available smart fixes (see *screenshot*). Select a fix to apply it immediately.

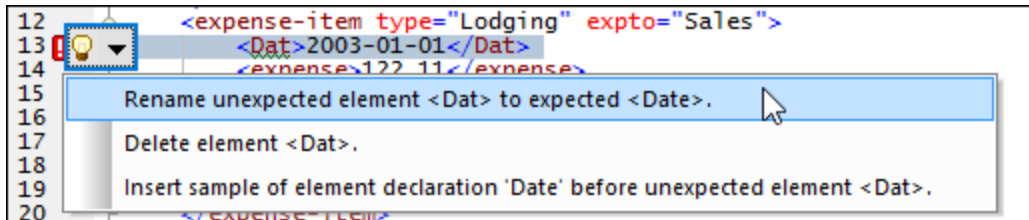

Note the following points:

- Validation error indicators and smart fixes are available for document types that can be validated in XMLSpy, for example JSON documents.
- The validation error indicators and smart fixes described above are refreshed only when the **XML | Validate (F8)** command is executed; they are not updated in the background. So, after correcting an error, you must run the **Validate (F8)** command again to make sure that the error has indeed been fixed.

For more information about validating an XML document, see the description of the [Validate](#)⁸⁵⁷ command.

Validation and Schema Manager

If a document is validated against a schema that is not installed but is available via [Schema Manager](#)³⁰⁷, then the installation via Schema Manager will be triggered automatically. However, if the schema package to be installed via Schema Manager contains namespace mappings, then there will be no automatic installation; in this case, you must start Schema Manager, select the package/s you want to install, and run the installation. If, after installation, XMLSpy is not able to correctly locate a schema component, then restart XMLSpy and try again.

Validate on editing

When the *Validate on Edit* mode is toggled on, well-formed checks and validation checks are carried out as you modify a document in Text View (and also in JSON Grid View). For validation to be carried out (additional to well-formed checks), a DTD or an XML Schema must be assigned to the XML document (a JSON Schema must be assigned to a JSON document). Errors are shown by error indicators (see above) in the left margin and on the lines containing the errors.

The *Validate on Edit* mode can be toggled on/off either (i) via the **XML | Validate on Edit**⁸⁶³ menu command, (ii) the **Validate on Edit** toolbar button, or (iii) via the *On Edit* option of the [Validation settings of the Options dialog](#)¹⁰⁴¹.

5.8 Whitespace

Whitespace characters are the space, tab, carriage return, and linefeed characters. You can switch on the display of whitespace markers (space, tab, and end-of-line (EOL) markers) in the Text View Settings dialog ([View | Text View Settings](#)⁹⁹⁵).

In an XML document, whitespace characters occur for the following reasons:

- For XML syntax reasons, usually to delimit XML constructs. Such whitespace is marked yellow in the screenshot below.
- Significant whitespace, which occurs within an element, attribute, or processing instruction, and should not be ignored because it has meaning. These are marked blue in the screenshot below.
- Insignificant whitespace, which occurs between two elements that have no sibling text nodes. Insignificant whitespace would therefore occur only in elements that are not mixed content. It is usually used for formatting purposes and does not have any meaning. Insignificant whitespace is marked green in the screenshot below.

```
1  <?xml version="1.0" encoding="UTF-8"?>EOL
2  <expense-report>EOL
3  ... <Person>EOL
4  ..... <First>Fred</First>EOL
5  ..... <Last>Landis</Last>EOL
6  ..... <Title>Project Manager</Title>EOL
7  ..... <Phone>123-456-7890</Phone>EOL
8  ... </Person>EOL
9  ... <expense-item type="Lodging" expto="Sales">EOL
10 ..... <Date>2021-01-01</Date>EOL
11 ..... <expense>722.11</expense>EOL
12 ..... <description>Room rentEOL
13 ..... Dinner x3EOL
14 ..... Breakfast x2</description>EOL
15 ... </expense-item>EOL
16 </expense-report>
```

In XMLSpy, whitespace is added when you pretty-print a document ([Edit | Pretty-Print](#)⁸¹²⁸¹²). The pretty-print action adds insignificant whitespace in order to format the document so that the document structure is clearly shown. Pretty-printing might also collapse significant whitespace depending on the options that are currently set for pretty-printing (see *screenshot below*).

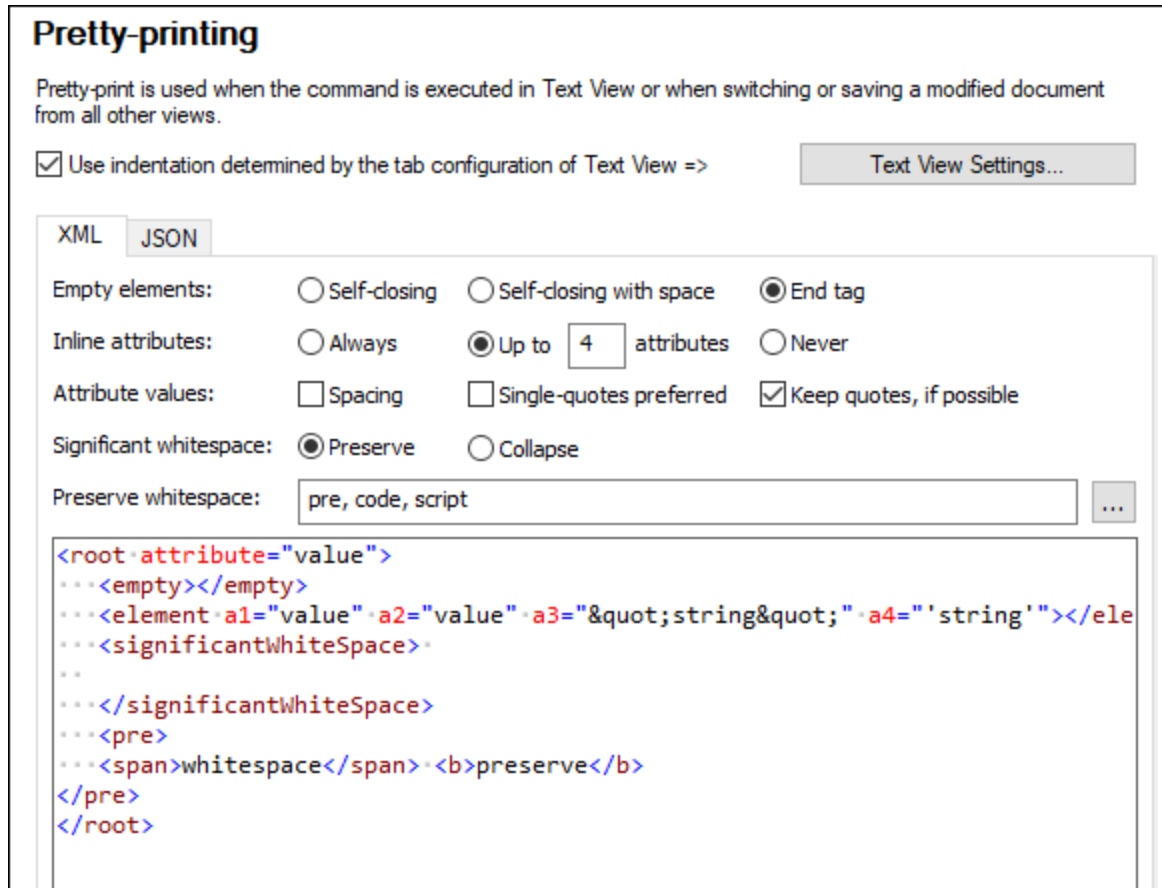

In the [pretty-printing options](#)¹⁰⁴⁶, the following settings affect how whitespace is handled:

- *Significant whitespace* can be preserved or collapsed. If this option is set to *Collapse*, you can, however, still preserve whitespace in specific elements by adding these elements to the *Preserve whitespace* list.
- The *Preserve whitespace* option enables you to create a list of elements in which all whitespace (both significant and insignificant) is preserved.
- If significant whitespace exists in an empty element, then it will be removed if *Significant whitespace* has been set to *Collapse*. The setting of the *Empty elements* option would determine how the empty element is displayed when its significant whitespace has been removed.

Note: When you change view between Text View and Grid View, any change that results from pretty-printing will be retained. In the case of a change to/from one of these views to another view, changes will not be applied.

5.9 Inserting XML Fragments

You can insert XML fragments from other applications and web pages. These fragments can be inserted in one of two ways:

- By using drag-and-drop to Text View or Grid View. If you drag-and-drop to Grid View, the [intelligent information available in drag overlays](#)¹⁷² can help you decide where to drop the fragment.
- By using copy-and-paste to Text View or Grid View.

Example

The following example shows how a fragment can be added quickly and to the correct location in an XML document.

1. The fragment that is highlighted below (from an XML tutorial at w3schools.com) is selected. It is an element named `food` that contains a number of child elements.

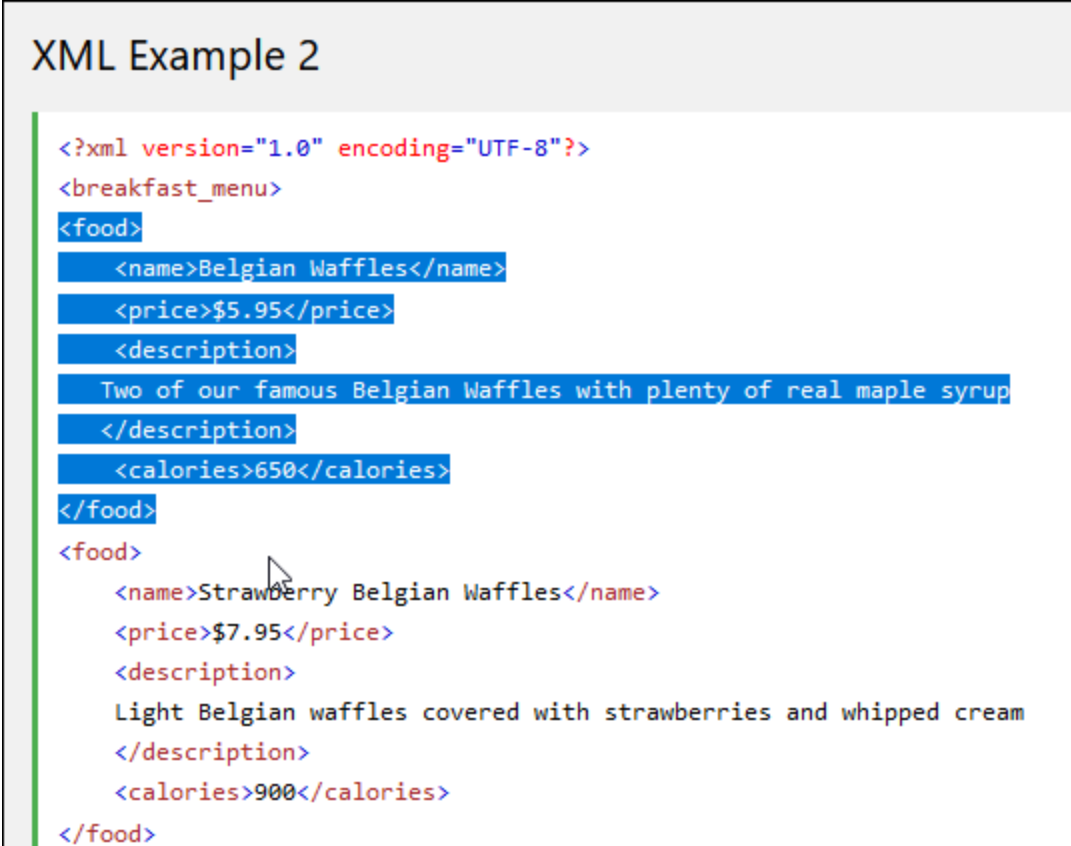

The screenshot shows an XML document titled "XML Example 2". The code is as follows:

```
<?xml version="1.0" encoding="UTF-8"?>
<breakfast_menu>
  <food>
    <name>Belgian Waffles</name>
    <price>$5.95</price>
    <description>
      Two of our famous Belgian Waffles with plenty of real maple syrup
    </description>
    <calories>650</calories>
  </food>
  <food>
    <name>Strawberry Belgian Waffles</name>
    <price>$7.95</price>
    <description>
      Light Belgian waffles covered with strawberries and whipped cream
    </description>
    <calories>900</calories>
  </food>
```

The fragment consisting of the second `<food>` element and its children is highlighted in blue. A mouse cursor is positioned over the `<name>` tag of this fragment.

2. The screenshot below shows the Grid View of an XML document, where two `food` elements are displayed as the rows of a table. When the fragment from the web page is dragged to the `food` table, a [drag overlay](#)¹⁷² appears containing the information that the dragged XML fragment will be dropped as a `food` element into the `food` table as its last row.



The screenshot shows the XMLSpy interface. The XML document is <?xml version="1.0" encoding="UTF-8"?>. The root element is <breakfast_menu>. It contains two <food> elements. A third <food> element is being dragged from the bottom into the list of children.

	<> name	<> price	<> description	<> calories
1	French Toast	\$4.50	Thick slices made from our homemade sourdough bread	600
2	Homestyle Breakfast	\$6.95	Two eggs, bacon or sausage, toast, and our ever-popular hash browns	950

3. When the fragment is dropped, it is placed exactly where it is wanted—as the last `food` element child of `breakfast_menu` (see screenshot below).

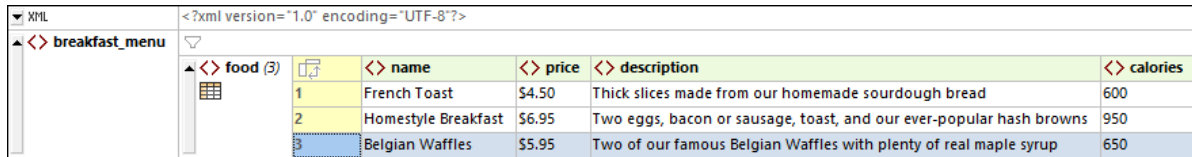

The screenshot shows the XMLSpy interface after the fragment has been dropped. The XML document is <?xml version="1.0" encoding="UTF-8"?>. The root element is <breakfast_menu>. It now contains three <food> elements. The third element, 'Belgian Waffles', is highlighted in blue.

	<> name	<> price	<> description	<> calories
1	French Toast	\$4.50	Thick slices made from our homemade sourdough bread	600
2	Homestyle Breakfast	\$6.95	Two eggs, bacon or sausage, toast, and our ever-popular hash browns	950
3	Belgian Waffles	\$5.95	Two of our famous Belgian Waffles with plenty of real maple syrup	650

5.10 Processing with XSLT and XQuery

XML documents can be processed with XSLT or XQuery documents to produce output documents. XMLSpy has built-in XSLT 1.0, XSLT 2.0, XSLT 3.0, XQuery 1.0, and XQuery 3.0 processors. The following processing-related features are available in the GUI:

- [Assigning XSLT stylesheets](#) ³⁰⁰
- [Go to XSLT](#) ³⁰⁰
- [XSLT parameters and XQuery variables](#) ³⁰¹
- [XSLT transformations](#) ³⁰¹
- [XQuery executions](#) ³⁰¹
- [Automating XML tasks with RaptorXML](#) ³⁰¹

Assigning XSLT stylesheets

You can assign an XSLT stylesheet to an XML document via the **XSL/XQuery | Assign XSL** command (browse for the file in the dialog (*screenshot below*) that pops up). The assignment is entered in the XML document as a processing instruction (PI) having the standard XSLT target defined by the W3C: `xml-stYLESHEET`. This assignment is used when an XSLT transformation is invoked (**XSL/XQuery | XSL Transformation**).

Additionally, an XSLT-for-FO stylesheet can be assigned with the **XSL/XQuery | Assign XSL:FO** command (browse for the file in the dialog (*screenshot below*) that pops up). The assignment is entered in the XML document as a processing instruction (PI) having the Altova-defined target: `altova_xslfo`. This assignment is used when an XSLT-for-FO transformation is invoked (**XSL/XQuery | XS:FO Transformation**).

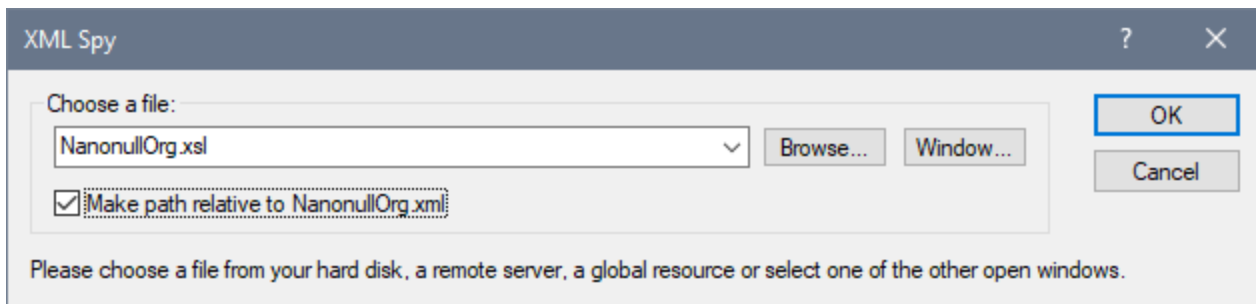

You can also select a global resource to specify the XSLT file. A global resource is an alias for a file or folder. The target file or folder can be changed within the GUI by changing the active configuration of the global resource (via the menu command **Tools | Active Configuration**). Global resources therefore enable the assigned XSLT file to be switched from one to another, which can be useful for testing. How to use global resources is described in the section [Altova Global Resources](#) ⁶⁹⁶.

If a previous assignment using either of these PI targets exists, then you are asked whether you wish to overwrite the existing assignment.

Go to XSLT

The **XSL/XQuery | Go to XSL** command opens the XSLT file that has been assigned to the XML document.

XSLT parameters and XQuery variables

XSLT parameters and XQuery variables can be defined, edited, and deleted in the dialog that appears on clicking the command **XSL/XQuery | XSLT Parameters / XQuery Variables**. The parameter/variable values defined here are used for all XSLT transformations and XQuery executions in XMLSpy. However, these values will not be passed to external engines such as MSXML. For the details of how to use this feature, see the [User Reference section](#) ⁹¹⁰.

XSLT transformations

Two types of XSLT transformation are available:

- Standard XSLT transformation (**XSL/XQuery | XSL Transformation**): The output of the transformation is displayed in a new window or, if specified in the stylesheet, is saved to a file location. The engine used for the transformation is specified in the [XSL tab](#) ¹⁰⁶⁸ of the Options dialog ([Tools | Options](#) ¹⁰⁴⁰).
- XSL-for-FO transformation (**XSL/XQuery | XSL-FO Transformation**): The XML document is transformed to PDF in a two-step process. In the first step, the XML document is transformed to an FO document using the XSLT processor specified in the [XSL tab](#) ¹⁰⁶⁸ of the Options dialog ([Tools | Options](#) ¹⁰⁴⁰); note that you can also select (at the bottom of the tab) the XSLT engine that comes with some FO processors such as FOP. In the second step, the FO document is processed by the FO processor specified in the [XSL tab](#) ¹⁰⁶⁸ of the Options dialog ([Tools | Options](#) ¹⁰⁴⁰) to produce PDF output.

Note: An FO document (which is a particular type of XML document) can be transformed to PDF by clicking the XSL:FO transformation command. When the source document is an FO document, the second step of the two-step process for this command is executed directly.

XQuery executions

An XQuery document can be executed on the active XML document by clicking the command **XSL/XQuery | XQuery Execution**. You are prompted for the XQuery file, and the result document is displayed in a new window in the GUI.

Automating XML tasks with RaptorXML

Altova RaptorXML is an application that provides XML validation, XSLT transformations, and XQuery executions. It can be used from the command line, via a COM interface, in Java programs, and in .NET applications. Tasks such as XSLT transformation can therefore be automated with the use of RaptorXML. For example, you can create a batch file that calls RaptorXML to transform a set of documents. See the [RaptorXML documentation](#) for details.

5.11 PDF Fonts

How the formatter and PDF Viewer use fonts

The formatter (for example, FOP) creates the PDF and the PDF Viewer (typically Adobe's Adobe Reader) reads it.

In order to lay out the PDF, the formatter needs to know details about the fonts used in the document, particularly the widths of all the glyphs used. It needs this information to calculate line lengths, hyphenation, justification, etc. This information is known as the metrics of the font, and it is stored with each font. Some formatters can read the metrics directly from the system's font folder. Others (such as FOP) need the metrics in a special format it can understand. When the metrics of a font are available to the formatter, the formatter can successfully lay out the PDF. You must ensure that the font metrics files of all the fonts you use in your document are available to the formatter you are using.

The formatter can either reference a font or embed it in the PDF file. If the font is referenced, then the PDF Viewer (for example, Adobe Reader) typically will look for that font in its own font resource folder (which contains the Base 14 fonts) first, and then in the system's font folder. If the font is available, it will be used when the PDF is displayed. Otherwise the Viewer will use an alternative from its resource folder or generate an error. An alternative font may have different metrics and could therefore generate display errors.

If the formatter embeds a font in the PDF file, then the PDF Viewer uses the embedded font. The formatter may embed the entire character set of a font or only a subset that contains the glyphs used in the document. This factor affects the size of the PDF file and, possibly, copyright issues surrounding font use (see note below). You might be able to influence the choice between these two options when you set the options for your formatter.

XMLSpy and PDF fonts

In XMLSpy, a PDF is generated from an XSL-FO document (from now on FO document) by processing the XSL-FO document with an external FO processor such as FOP. (In the Options dialog, you can specify the location of the FO processor. This allows the FO processing to be started from within the XMLSpy GUI.)

The XSL-FO document itself is generated by processing an XML document with an XSLT stylesheet. (You can use either Altova's XSLT engine (which is built into XMLSpy) or an external XSLT engine to do this.)

The formatting for the PDF document, including the font properties of all text, is specified in the XSL-FO document. If the formatter you are using can read the metrics of the required font directly from the font, then all you need to do is to set up the formatter to access the font. If, however, you are using FOP as your formatter, you will need to provide it with the correct font metrics files for fonts other than the Base-14 fonts.

Making fonts available to the formatter

Most formatters (including FOP) already have available to them the Base 14 fonts. It is important to know the names by which the formatter recognizes these fonts so that you correctly indicate them to the formatter. This is the basic font support provided by formatters. You can, however, increase the number of fonts available to the formatter by carrying out a few straightforward steps specific to the formatter you are using. The steps for FOP are given below.

General procedure for setting up additional font support in FOP

To make additional fonts available to FOP, you would need to do the following:

1. Generate a font metrics file for the required font from the PostScript or TrueType font files. FOP provides PFM Reader and TTF Reader utilities to convert PostScript and TrueType fonts, respectively, to XML font metrics file. For details of how to do this, see the [FOP: Fonts](#) page.
2. Set up the FOP configuration file to use the required font metrics files. You do this by entering information about the font files in an FOP configuration file. See [FOP: Fonts](#).
3. In the file `fop.bat`, change the last line:

```
"%JAVACMD%" [...] org.apache.fop.cli.Main %FOP_CMD_LINE_ARGS%
```

to include the location of the configuration file:

```
"%JAVACMD%" [...] org.apache.fop.cli.Main %FOP_CMD_LINE_ARGS% -c conf\fop.xconf
```

After the metrics files are registered with FOP (in a FOP configuration file) and the FOP executable is set to read the configuration file, the additional fonts are available for PDF creation.

Setting up the FOP configuration file

The FOP configuration file is called `fop.xconf` and is located in the `conf` folder in the FOP installation folder. This file, which is an XML document, must be edited so that FOP reads the font metrics files correctly. For each font that you wish to have FOP render, add a `font` element at the location indicated by the `font-element` placeholder in the document:

```
<font metrics-url="arial.xml" kerning="yes" embed-url="arial.ttf">
  <font-triplet name="Arial" style="normal" weight="normal"/>
  <font-triplet name="ArialMT" style="normal" weight="normal"/>
</font>
```

In the example above,

<code>arial.xml</code>	is the URL of the metrics file; it is best to use an absolute path.
<code>arial.ttf</code>	is the name of the TTF file (usually located in <code>%WINDIR%\Fonts</code>).
<code>Arial</code>	specifies that the above metrics and TTF files will be used if the font-family is defined as <code>Arial</code> .
<code>style="normal"</code>	specifies that the above metrics and TTF files will be used if the font-style is defined as <code>normal</code> (not, say, <code>italic</code>).
<code>weight="normal"</code>	specifies that the above metrics and TTF files will be used if the font-weight is defined as <code>normal</code> (not, say, <code>bold</code>).

Note on font copyrights: Font usage is subject to copyright laws, and the conditions for use vary. Before embedding a font—especially if you are embedding the entire font—make sure that you are allowed to do so under the license you have purchased for that font.

Character sets

Note that the character sets of fonts differ from each other. The Base 14 fonts cover the ISO-8859-1 characters plus the glyphs in the Symbol and Zapf Dingbats fonts. If your document contains a character that is not

covered by the Base 14 fonts, then you will have to use a font that contains this character in its character set. Some fonts, such as Arial Unicode, offer the characters covered by Unicode.

6 DTDs and XML Schemas

Altova website: [XML Schema Editor](#)

This section provides an overview of how to work with [DTDs](#)³²³ and [XML Schemas](#)³²⁶. It also describes [SchemaAgent](#)³³⁷ and the powerful [Find in Schemas](#)³⁴⁸ feature. In addition to the editing features, XMLSpy provides the following powerful DTD/Schema features:

Catalog mechanism

Support for the OASIS [catalog mechanism](#)³³¹ enables the re-direction of URIs to local addresses, thus facilitating use across multiple workstations.

Schema subsets

Components of a large schema can, in Schema View, be created as a separate file. These smaller schema subsets can then be included in the larger schema. The reverse operation, known as flattening a schema, puts the components of included files directly in the larger schema. How to generate schema subsets and flatten schemas is described in the section, [Schema Subsets](#)³²⁷.

Converting DTDs to XMLSchemas and vice versa

A DTD can be converted to an XML Schema and vice versa, and both types of documents can be flattened via commands in the [DTD/Schema](#)⁸⁶⁸ menu. When a DTD is flattened, components in included/imported modules are saved directly in the parent file, and unused components are deleted.

Generate Sample XML file

You can generate, via the [DTD/Schema | Generate Sample XML/JSON File](#)⁸⁷⁹ menu command, a skeleton XML document based on the active DTD or XML Schema file. This is very useful for quickly creating an XML file based on the active schema.

Go to definition

When the cursor is located within a node in an XML document, clicking the [DTD/Schema | Go to Definition](#)⁸⁷¹ menu command opens the schema file and highlights the definition of the selected XML node.

6.1 Schema Manager

XML Schema Manager is an Altova tool that provides a centralized way to install and manage XML schemas (DTDs for XML and XML Schemas) for use across all Altova's XML-Schema-aware applications, including XMLSpy.

- On Windows, Schema Manager has a graphical user interface (*screenshot below*) and is also available at the command line. (Altova's desktop applications are available on Windows only; *see list below*.)
- On Linux and macOS, Schema Manager is available at the command line only. (Altova's server applications are available on Windows, Linux, and macOS; *see list below*.)

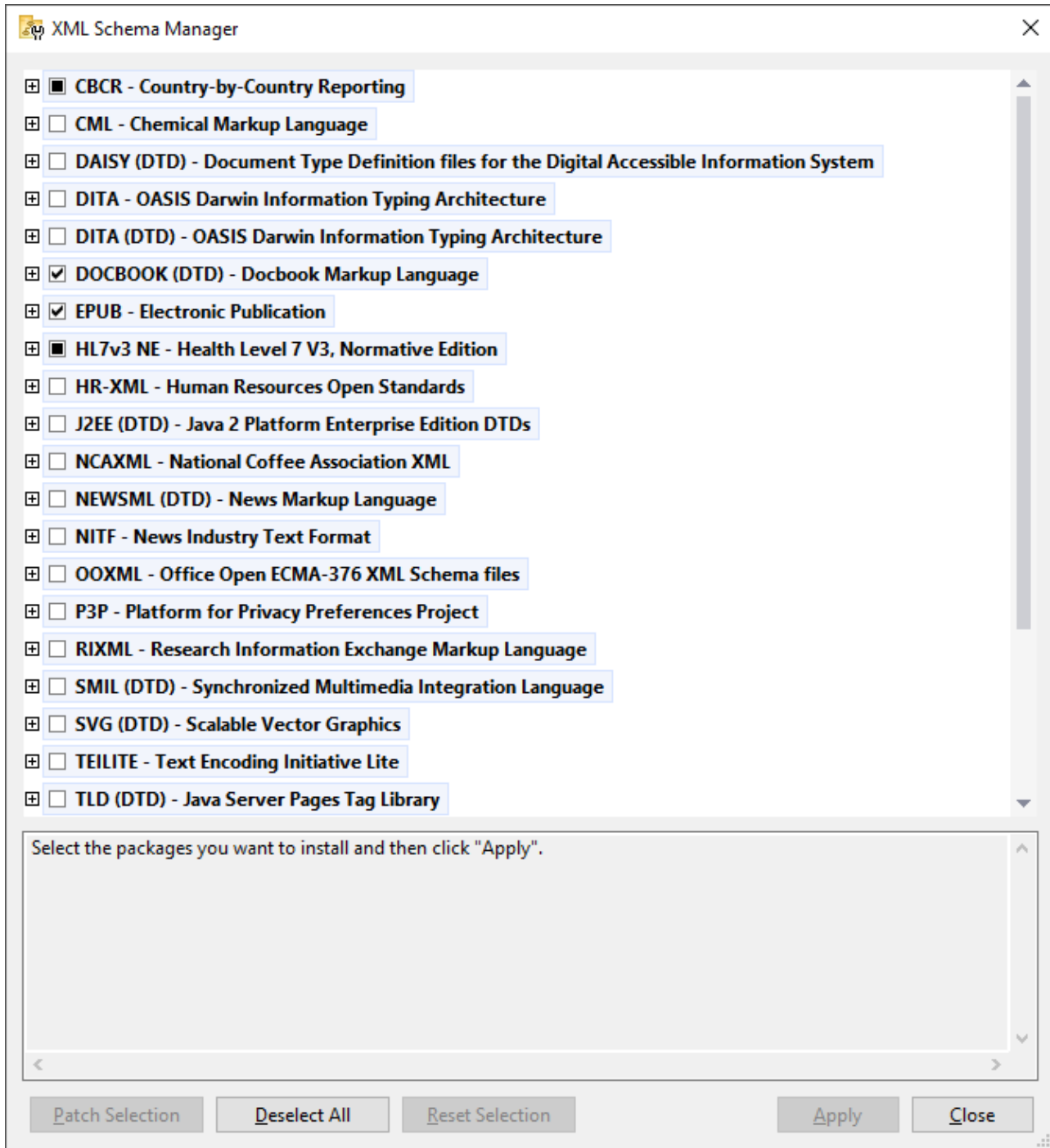

Altova applications that operate with Schema Manager

Desktop applications (Windows only)	Server applications (Windows, Linux, macOS)
XMLSpy (all editions)	RaptorXML Server, RaptorXML+XBRL Server

MapForce (all editions)	StyleVision Server
StyleVision (all editions)	
Authentic Desktop Enterprise Edition	

Installation and de-installation of Schema Manager

Schema Manager is installed automatically when you first install a new version of Altova Mission Kit or of any of Altova's XML-schema-aware applications (see *table above*).

Likewise, it is removed automatically when you uninstall the last Altova XML-schema-aware application from your computer.

Schema Manager features

Schema Manager provides the following features:

- Shows XML schemas installed on your computer and checks whether new versions are available for download.
- Downloads newer versions of XML schemas independently of the Altova product release cycle. (Altova stores schemas online, and you can download them via Schema Manager.)
- Install or uninstall any of the multiple versions of a given schema (or all versions if necessary).
- An XML schema may have dependencies on other schemas. When you install or uninstall a particular schema, Schema Manager informs you about dependent schemas and will automatically install or remove them as well.
- Schema Manager uses the [XML catalog](#) mechanism to map schema references to local files. In the case of large XML schemas, processing will therefore be faster than if the schemas were at a remote location.
- All major schemas are available via Schema Manager and are regularly updated for the latest versions. This provides you with a convenient single resource for managing all your schemas and making them readily available to all of Altova's XML-schema-aware applications.
- Changes made in Schema Manager take effect for all Altova products installed on that machine.
- In an Altova product, if you attempt to validate on a schema that is not installed but which is available via Schema Manager, then installation is triggered automatically. However, if the schema package contains namespace mappings, then there will be no automatic installation; in this case, you must start Schema Manager, select the package/s you want to install, and run the installation. If, after installation, your open Altova application does not restart automatically, then you must restart it manually.

How it works

Altova stores all XML schemas used in Altova products online. This repository is updated when new versions of the schemas are released. Schema Manager displays information about the latest available schemas when invoked in both its GUI form as well as on the CLI. You can then install, upgrade or uninstall schemas via Schema Manager.

Schema Manager also installs schemas in one other way. At the Altova website (<https://www.altova.com/schema-manager>) you can select a schema and its dependent schemas that you want to install. The website will prepare a file of type `.altova_xmlschemas` for download that contains information about your schema selection. When you double-click this file or pass it to Schema Manager via the CLI as an argument of the `install` ³¹⁸ command, Schema Manager will install the schemas you selected.

Local cache: tracking your schemas

All information about installed schemas is tracked in a centralized cache directory on your computer, located here:

<i>Windows</i>	C:\ProgramData\Altova\pkgs\.cache
<i>Linux</i>	/var/opt/Altova/pkgs\.cache
<i>macOS</i>	/var/Altova/pkgs

This cache directory is updated regularly with the latest status of schemas at Altova's online storage. These updates are carried out at the following times:

- Every time you start Schema Manager.
- When you start XMLSpy for the first time on a given calendar day.
- If XMLSpy is open for more than 24 hours, the cache is updated every 24 hours.
- You can also update the cache by running the [update](#)³²¹ command at the command line interface.

The cache therefore enables Schema Manager to continuously track your installed schemas against the schemas available online at the Altova website.

Do not modify the cache manually!

The local cache directory is maintained automatically based on the schemas you install and uninstall. It should not be altered or deleted manually. If you ever need to reset Schema Manager to its original "pristine" state, then, on the command line interface (CLI): (i) run the [reset](#)³¹⁹ command, and (ii) run the [initialize](#)³¹⁷ command. (Alternatively, run the `reset` command with the `--i` option.)

6.1.1 Run Schema Manager

Graphical User Interface

You can access the GUI of Schema Manager in any of the following ways:

- *During the installation of XMLSpy:* Towards the end of the installation procedure, select the check box *Invoke Altova XML-Schema Manager* to access the Schema Manager GUI straight away. This will enable you to install schemas during the installation process of your Altova application.
- *After the installation of XMLSpy:* After your application has been installed, you can access the Schema Manager GUI at any time, via the menu command **Tools | XML Schema Manager**.
- Via the `.altova_xmlschemas` file downloaded from the [Altova website](#): Double-click the downloaded file to run the Schema Manager GUI, which will be set up to install the schemas you selected (at the website) for installation.

After the Schema Manager GUI (*screenshot below*) has been opened, already installed schemas will be shown selected. If you want to install an additional schema, select it. If you want to uninstall an already installed schema, deselect it. After you have made your selections and/or deselections, you are ready to apply your changes. The schemas that will be installed or uninstalled will be highlighted and a message about the

upcoming changes will be posted to the Messages pane at the bottom of the Schema Manager window (see *screenshot*).

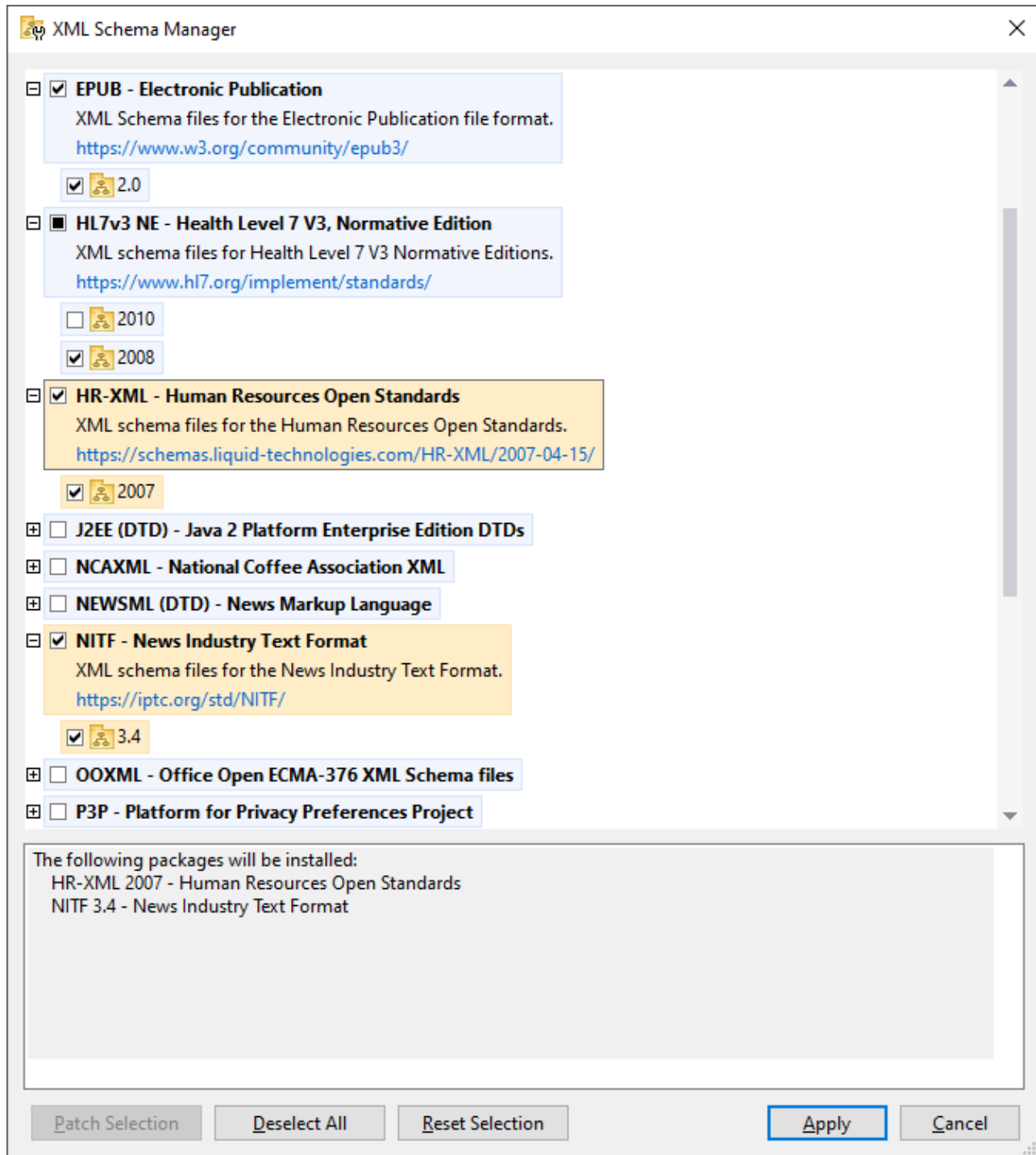

Command line interface

You can run Schema Manager from a command line interface by sending commands to its executable file, `xmlschemamanager.exe`.

The `xmlschemamanager.exe` file is located in the following folder:

- *On Windows:* C:\ProgramData\Altova\SharedBetweenVersions
- *On Linux or macOS (server applications only):* %INSTALLDIR%/bin, where %INSTALLDIR% is the program's installation directory.

You can then use any of the commands listed in the [CLI command reference section](#)³¹⁶.

To display help for the commands, run the following:

- *On Windows:* `xmlschemamanager.exe --help`
- *On Linux or macOS (server applications only):* `sudo ./xmlschemamanager --help`

6.1.2 Status Categories

Schema Manager categorizes the schemas under its management as follows:

- *Installed schemas.* These are shown in the GUI with their check boxes selected (*in the screenshot below the checked and blue versions of the EPUB and HL7v3 NE schemas are installed schemas*). If all the versions of a schema are selected, then the selection mark is a tick. If at least one version is unselected, then the selection mark is a solid colored square. You can deselect an installed schema to **uninstall** it; (*in the screenshot below, the DocBook DTD is installed and has been deselected, thereby preparing it for de-installation*).
- *Uninstalled available schemas.* These are shown in the GUI with their check boxes unselected. You can select the schemas you want to **install**.



- *Upgradeable schemas* are those which have been revised by their issuers since they were installed. They are indicated in the GUI by a 📦 icon. You can **patch** an installed schema with an available revision.

Points to note

- In the screenshot above, both CBCR schemas are checked. The one with the blue background is already installed. The one with the yellow background is uninstalled and has been selected for installation. Note that the HL7v3 NE 2010 schema is not installed and has not been selected for installation.
- A yellow background means that the schema will be modified in some way when the **Apply** button is clicked. If a schema is unchecked and has a yellow background, it means that it will be uninstalled when the **Apply** button is clicked. In the screenshot above the DocBook DTD has such a status.
- When running Schema Manager from the command line, the `list` ³¹⁸ command is used with different options to list different categories of schemas:

<code>xmlschemamanager.exe list</code>	Lists all installed and available schemas; upgradeables are also indicated
<code>xmlschemamanager.exe list -i</code>	Lists installed schemas only; upgradeables are also indicated
<code>xmlschemamanager.exe list -u</code>	Lists upgradeable schemas



Note: On Linux and macOS, use `sudo ./xmlschemamanager list`

6.1.3 Patch or Install a Schema

Patch an installed schema

Occasionally, XML schemas may receive patches (upgrades or revisions) from their issuers. When Schema Manager detects that patches are available, these are indicated in the schema listings of Schema Manager and you can install the patches quickly.

In the GUI

Patches are indicated by the  icon. (Also see the previous topic about [status categories](#)³¹².) If patches are available, the **Patch Selection** button will be enabled. Click it to select and prepare all patches for installation. In the GUI, the icon of each schema that will be patched changes from  to , and the Messages pane at the bottom of the dialog lists the patches that will be applied. When you are ready to install the selected patches, click **Apply**. All patches will be applied together. Note that if you deselect a schema marked for patching, you will actually be uninstalling that schema.

On the CLI

To apply a patch at the command line interface:

1. Run the `list -u`³¹⁸ command. This lists any schemas for which upgrades are available.
2. Run the `upgrade`³²¹ command to install all the patches.

Install an available schema

You can install schemas using either the Schema Manager GUI or by sending Schema Manager the install instructions via the command line.

Note: If the current schema references other schemas, the referenced schemas are also installed.

In the GUI

To install schemas using the Schema Manager GUI, select the schemas you want to install and click **Apply**.

You can also select the schemas you want to install at the [Altova website](#) and generate a downloadable `.altova_xmlschemas` file. When you double-click this file, it will open Schema Manager with the schemas you wanted pre-selected. All you will now have to do is click **Apply**.

On the CLI

To install schemas via the command line, run the `install`³¹⁸ command:

```
xmlschemamanager.exe install [options] Schema+
```

where `Schema` is the schema (or schemas) you want to install or a `.altova_xmlschemas` file. A schema is referenced by an identifier of format `<name>-<version>`. (The identifiers of schemas are displayed when you run the `list`³¹⁸ command.) You can enter as many schemas as you like. For details, see the description of the `install`³¹⁸ command.

Note: On Linux or macOS, use the `sudo ./xmlschemamanager` command.

Installing a required schema

When you run an XML-schema-related command in XMLSpy and XMLSpy discovers that a schema it needs for executing the command is not present or is incomplete, Schema Manager will display information about the missing schema/s. You can then directly install any missing schema via Schema Manager.

In the Schema Manager GUI, you can view all previously installed schemas at any time by running Schema Manager from **Tools | Schema Manager**.

6.1.4 Uninstall a Schema, Reset

Uninstall a schema

You can uninstall schemas using either the Schema Manager GUI or by sending Schema Manager the uninstall instructions via the command line.

Note: If the schema you want to uninstall references other schemas, then the referenced schemas are also uninstalled.

In the GUI

To uninstall schemas in the Schema Manager GUI, clear their check boxes and click **Apply**. The selected schemas and their referenced schemas will be uninstalled.

To uninstall all schemas, click **Deselect All** and click **Apply**.

On the CLI

To uninstall schemas via the command line, run the `uninstall`³²⁰ command:

```
xmlschemamanager.exe uninstall [options] Schema+
```

where each `schema` argument is a schema you want to uninstall or a `.altova_xmlschemas` file. A schema is specified by an identifier that has a format of `<name>-<version>`. (The identifiers of schemas are displayed when you run the `list`³¹⁸ command.) You can enter as many schemas as you like. For details, see the description of the `uninstall`³²⁰ command.

Note: On Linux or macOS, use the `sudo ./xmlschemamanager` command.

Reset Schema Manager

You can reset Schema Manager. This removes all installed schemas and the cache directory.

- In the GUI, click **Reset Selection**.
- On the CLI, run the `reset`³¹⁹ command.

After running this command, make sure to run the `initialize`³¹⁷ command in order to recreate the cache directory. Alternatively, run the `reset`³¹⁹ command with the `-i` option.

Note that `reset -i`³¹⁹ restores the original installation of the product, so it is recommended to run the `update`³²¹ command after performing a reset. Alternatively, run the `reset`³¹⁹ command with the `-i` and `-u` options.

6.1.5 Command Line Interface (CLI)

To call Schema Manager at the command line, you need to know the path of the executable. By default, the Schema Manager executable is installed here:

```
C:\ProgramData\Altova\SharedBetweenVersions\XMLSchemaManager.exe
```

Note: On Linux and macOS systems, once you have changed the directory to that containing the executable, you can call the executable with `sudo ./xmlschemamanager`. The prefix `./` indicates that the executable is in the current directory. The prefix `sudo` indicates that the command must be run with root privileges.

Command line syntax

The general syntax for using the command line is as follows:

```
<exec> -h | --help | --version | <command> [options] [arguments]
```

In the listing above, the vertical bar `|` separates a set of mutually exclusive items. The square brackets `[]` indicate optional items. Essentially, you can type the executable path followed by either `--h`, `--help`, or `--version` options, or by a command. Each command may have options and arguments. The list of commands is described in the following sections.

6.1.5.1 help

This command provides contextual help about commands pertaining to Schema Manager executable.

Syntax

```
<exec> help [command]
```

Where `[command]` is an optional argument which specifies any valid command name.

Note the following:

- You can invoke help for a command by typing the command followed by `-h` or `--help`, for example:

```
<exec> list -h
```
- If you type `-h` or `--help` directly after the executable and before a command, you will get general help (not help for the command), for example:

```
<exec> -h list
```

Example

The following command displays help about the `list` command:

```
xmlschemamanager help list
```

6.1.5.2 info

This command displays detailed information for each of the schemas supplied as a `Schema` argument. This information for each submitted schema includes the title, version, description, publisher, and any referenced schemas, as well as whether the schema has been installed or not.

Syntax

```
<exec> info [options] Schema+
```

- The `Schema` argument is the name of a schema or a part of a schema's name. (To display a schema's package ID and detailed information about its installation status, you should use the [list](#)³¹⁸ command.)
- Use `<exec> info -h` to display help for the command.

Example

The following command displays information about the latest `DocBook-DTD` and `NITF` schemas:

```
xmlschemamanager info doc nitf
```

6.1.5.3 initialize

This command initializes the Schema Manager environment. It creates a cache directory where information about all schemas is stored. Initialization is performed automatically the first time a schema-cognizant Altova application is installed. You would not need to run this command under normal circumstances, but you would typically need to run it after executing the `reset` command.

Syntax

```
<exec> initialize | init [options]
```

Options

The `initialize` command takes the following options:

<code>--silent, --s</code>	Display only error messages. The default is <code>false</code> .
<code>--verbose, --v</code>	Display detailed information during execution. The default is <code>false</code> .
<code>--help, --h</code>	Display help for the command.

Example

The following command initializes Schema Manager:

```
xmlschemamanager initialize
```

6.1.5.4 install

This command installs one or more schemas.

Syntax

```
<exec> install [options] Schema+
```

To install multiple schemas, add the `schema` argument multiple times.

The `schema` argument is one of the following:

- A schema identifier (having a format of `<name>-<version>`, for example: `cocr-2.0`). To find out the schema identifiers of the schemas you want, run the [list](#)³¹⁸ command. You can also use an abbreviated identifier if it is unique, for example `docbook`. If you use an abbreviated identifier, then the latest version of that schema will be installed.
- The path to a `.altova_xmlschemas` file downloaded from the Altova website. For information about these files, see [Introduction to SchemaManager: How It Works](#)³⁰⁷.

Options

The `install` command takes the following options:

<code>--silent, --s</code>	Display only error messages. The default is <code>false</code> .
<code>--verbose, --v</code>	Display detailed information during execution. The default is <code>false</code> .
<code>--help, --h</code>	Display help for the command.

Example

The following command installs the CBCR 2.0 (Country-By-Country Reporting) schema and the latest DocBook DTD:

```
xmlschemamanager install cocr-2.0 docbook
```

6.1.5.5 list

This command lists schemas under the management of Schema Manager. The list displays one of the following

- All available schemas
- Schemas containing in their name the string submitted as a `Schema` argument
- Only installed schemas
- Only schemas that can be upgraded

Syntax

```
<exec> list | ls [options] Schema?
```

If no `Schema` argument is submitted, then all available schemas are listed. Otherwise, schemas are listed as specified by the submitted options (see *example below*). Note that you can submit the `schema` argument multiple times.

Options

The `list` command takes the following options:

<code>--installed, --i</code>	List only installed schemas. The default is <code>false</code> .
<code>--upgradeable, --u</code>	List only schemas where upgrades (patches) are available. The default is <code>false</code> .
<code>--help, --h</code>	Display help for the command.

Examples

- To list all available schemas, run: `xmlschemamanager list`
- To list installed schemas only, run: `xmlschemamanager list -i`
- To list schemas that contain either "doc" or "nitf" in their name, run: `xmlschemamanager list doc nitf`

6.1.5.6 reset

This command removes all installed schemas and the cache directory. You will be completely resetting your schema environment. After running this command, be sure to run the [initialize](#)³¹⁷ command to recreate the cache directory. Alternatively, run the `reset` command with the `-i` option. Since `reset -i` restores the original installation of the product, we recommend that you run the [update](#)³²¹ command after performing a reset and initialization. Alternatively, run the `reset` command with both the `-i` and `-u` options.

Syntax

```
<exec> reset [options]
```

Options

The `reset` command takes the following options:

<code>--init, --i</code>	Initialize Schema Manager after reset. The default is <code>false</code> .
<code>--update, --u</code>	Updates the list of available schemas in the cache. The default is <code>false</code> .

<code>--silent, --s</code>	Display only error messages. The default is <code>false</code> .
<code>--verbose, --v</code>	Display detailed information during execution. The default is <code>false</code> .
<code>--help, --h</code>	Display help for the command.

Examples

- To reset Schema Manager, run: `xmlschemamanager reset`
- To reset Schema Manager and initialize it, run: `xmlschemamanager reset -i`
- To reset Schema Manager, initialize it, and update its schema list, run: `xmlschemamanager reset -i -u`

6.1.5.7 uninstall

This command uninstalls one or more schemas. By default, any schemas referenced by the current one are uninstalled as well. To uninstall just the current schema and keep the referenced schemas, set the option `--k`.

Syntax

```
<exec> uninstall [options] Schema+
```

To uninstall multiple schemas, add the `schema` argument multiple times.

The `schema` argument is one of the following:

- A schema identifier (having a format of `<name>-<version>`, for example: `cbcr-2.0`). To find out the schema identifiers of the schemas that are installed, run the `list -i`³¹⁸ command. You can also use an abbreviated schema name if it is unique, for example `docbook`. If you use an abbreviated name, then all schemas that contain the abbreviation in its name will be uninstalled.
- The path to a `.altova_xmlschemas` file downloaded from the Altova website. For information about these files, see [Introduction to SchemaManager: How It Works](#)³⁰⁷.

Options

The `uninstall` command takes the following options:

<code>--keep-references, --k</code>	Set this option to keep referenced schemas. The default is <code>false</code> .
<code>--silent, --s</code>	Display only error messages. The default is <code>false</code> .
<code>--verbose, --v</code>	Display detailed information during execution. The default is <code>false</code> .
<code>--help, --h</code>	Display help for the command.

Example

The following command uninstalls the CBCR 2.0 and EPUB 2.0 schemas and their dependencies:

```
xmlschemamanager uninstall cbcr-2.0 epub-2.0
```

The following command uninstalls the `eba-2.10` schema but not the schemas it references:

```
xmlschemamanager uninstall --k cbc-2.0
```

6.1.5.8 update

This command queries the list of schemas available from the online storage and updates the local cache directory. You should not need to run this command unless you have performed a [reset](#)³¹⁹ and [initialize](#)³¹⁷.

Syntax

```
<exec> update [options]
```

Options

The `update` command takes the following options:

<code>--silent, --s</code>	Display only error messages. The default is <code>false</code> .
<code>--verbose, --v</code>	Display detailed information during execution. The default is <code>false</code> .
<code>--help, --h</code>	Display help for the command.

Example

The following command updates the local cache with the list of latest schemas:

```
xmlschemamanager update
```

6.1.5.9 upgrade

This command upgrades all installed schemas that can be upgraded to the latest available *patched* version. You can identify upgradeable schemas by running the [list -u](#)³¹⁸ command.

Note: The `upgrade` command removes a deprecated schema if no newer version is available.

Syntax

```
<exec> upgrade [options]
```

Options

The `upgrade` command takes the following options:

<code>--silent, --s</code>	Display only error messages. The default is <code>false</code> .
<code>--verbose, --v</code>	Display detailed information during execution. The default is <code>false</code> .

`--help, --h` Display help for the command.

6.2 DTDs

A DTD document can be edited in Text View and Grid View. The default view can be set in the [File Types section](#)¹⁰⁴³ of the Options dialog.

Text View

In Text View, the document is displayed with syntax coloring and must be typed in. Given below is a sample of a DTD fragment:

```
<?xml version="1.0" encoding="UTF-8"?>
<!--Element declarations-->
<!ELEMENT document (header, para+, img+, link+)>
<!ELEMENT header (#PCDATA)>
<!ELEMENT img EMPTY>
  <!ATTLIST img
    src CDATA #REQUIRED
  >

<!-- Notation Declarations -->
<!NOTATION GIF PUBLIC "urn:mime:img/gif">
```

Indentation is indicated by indentation guides and is best obtained by using the tab key. The amount of tab indentation can be set in the [Text View Settings dialog](#)¹³³.

Grid View

In Grid View, the DTD document is displayed as a table. The screenshot below shows the Grid View display of the DTD listed above.

XML	<?xml version="1.0" encoding="UTF-8"?>	
<!-- Element declarations		
▲ Elm document	≡ sequence	exactly 1
	▲ Elm header	exactly 1
	▲ Elm para	1 or more
	▲ Elm img	1 or more
	▲ Elm link	1 or more
▲ Elm header	≡ mixed	
▲ Elm img	≡ empty	
▲ Att. img	▲ src	
	type	≡ CDATA
	value	≡ REQUIRED
<!-- Notation Declarations		
▲ Not GIF	▲ ID. External ID	
	public	urn:mime:img/gif
	system	

Editing DTD structure

- When the cursor is inside a cell you can insert or append nodes, or add a child node, via the context menu or the **XML** menu.
- Click the node's type icon at the top left of the cell to change the node type.
- Change the content model (*sequence*, *mixed*, *empty*, etc) and occurrence modifier (*exactly 1*, *1 or more*, etc) of a node by clicking the respective icon and selecting the option you want.
- You can also use drag-and-drop to move nodes to new locations in the document, as well as copy-paste to copy nodes to new locations.

Editing DTD values

- To edit values such as element and attribute names and comments, double-click in the cell and edit.

Grid View toolbar

The Grid View toolbar provides access to the view's settings dialog and contains commands, such as to set magnification and word-wrapping.

DTD features in XMLSpy

XMLSpy offers the following very useful features:

- *Convert DTD to XML Schema*: With the [DTD/Schema | Convert DTD to Schema](#)⁸⁷⁴ command, DTDs can be converted to XML Schemas.

- *Generate sample XML file from DTD:* With the [DTD/Schema | Generate Sample XML/JSON File](#)⁸⁷⁹ command, an XML document can be generated that is based on the active DTD.

6.3 XML Schemas

XML Schema documents can be edited in Text View, Grid View, and Schema View. The default view in which XML Schema documents open can be set in the [File Types section](#)¹⁰⁴³ of the Options dialog. You can switch between views while you edit, using the view that is most useful for the current purpose. XML Schema documents are typically saved with the extension `.xsd` or `.xs`.

Editing in Text View

In Text View an XML Schema is edited as an XML document; the [editing features available for XML documents](#)²⁸⁷ are also available for XML Schemas. As with all XML documents where the schema is identified and accessible, [Text View entry helpers](#)¹⁴² display the items available for addition at the cursor location point.

Editing in Grid View

In Grid View an XML Schema is edited as an XML document; the [editing features available for XML documents](#)¹⁴⁶ are also available for XML Schemas. When an item in Grid View is selected, [Grid View entry helpers](#)¹⁵⁵ display the items available for addition at the cursor location point.

Editing in Schema View

Schema View is a graphical interface for designing schemas. While you create/edit the schema in Schema View, XMLSpy generates a corresponding text document behind the interface. How to create and edit XML Schema documents in Schema View is described in detail in the section [Editing Views | Schema View](#)¹⁹⁸.

Altova website:  [XML Schema Editor](#)

XML Schema features in XMLSpy

Additionally, XMLSpy offers the following very useful features:

- *Convert XML Schema to DTD:* With the [DTD/Schema | Convert Schema to DTD](#)⁸⁷⁷ command, XML Schemas can be converted to DTDs.
- *Generate sample XML file from XML Schema:* With the [DTD/Schema | Generate Sample XML File](#)⁸⁷⁹ command, an XML document can be generated that is based on the active XML Schema. Sample values can also be specified for elements and attributes in the sample XML.

6.4 Schema Subsets

One or more components of an XML Schema can be created as a separate schema file, known as a schema subset. The advantage of using smaller schema subsets to compose the larger schema (by means of Includes) is that the smaller files are more manageable than the single full schema.

In Schema View, one possible work scenario that describes various aspects of the Schema Subsets feature is as follows:

1. Create a schema subset that contains one or more components of the active schema. How to do this is [described below](#)³²⁷,
2. Create additional schema subsets as required.
3. Include the newly created schema subset/s to compose the larger schema. Do this for each schema subset by appending or inserting an Include component in the [Schema Overview window](#)²⁰⁴, and selecting the newly created schema subset file.
4. Delete any components that were present in the original full schema but are now duplicated because of the included subset/s.

You can also do the reverse in Schema View, that is, flatten the included schema subsets so that: (i) the components contained in the schema subsets are added directly to the main schema, and (ii) the included schema subsets are deleted from the main schema. How to flatten a schema is [described further below](#)³²⁹.

Creating schema subsets

To create a schema subset, do the following:

1. With the required XML Schema active in Schema View, select the command **Schema Design | Create Schema Subset**. This pops up the Select Schema Components dialog (*screenshot below*).
2. In the dialog, check the component or components you wish to create as a single schema subset, then click **Next**. (Note that a check box below the pane enables components from all referenced files to also be listed for selection.)

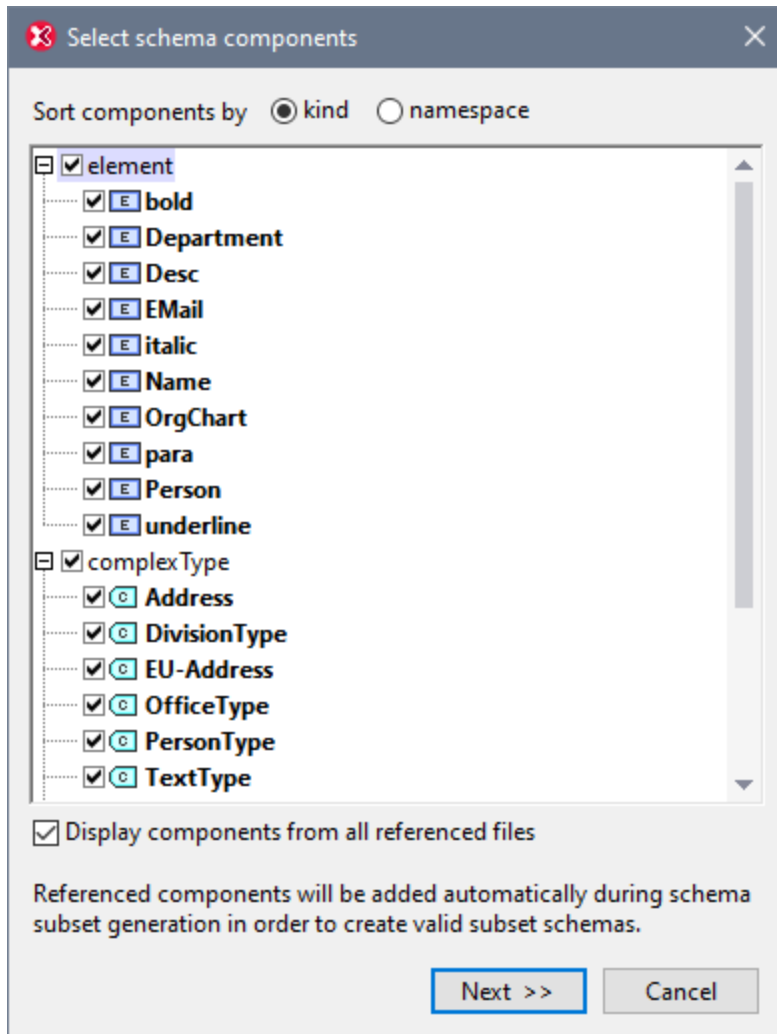

3. In the Schema Subset Generation dialog that now appears (*screenshot below*), enter the name/s you want the file/s of the schema subset package to have. You must also specify the folder in which the new schema subset files are to be saved. A schema subset package could have multiple files if one or more of the components being created is an imported component in the original schema. A separate schema file is created for each namespace in the schema subset. The filenames displayed in the dialog are, by default, the names of the original files. But since you are not allowed to overwrite the original files, use new filenames if you wish to save the files in the same folder as the original files.

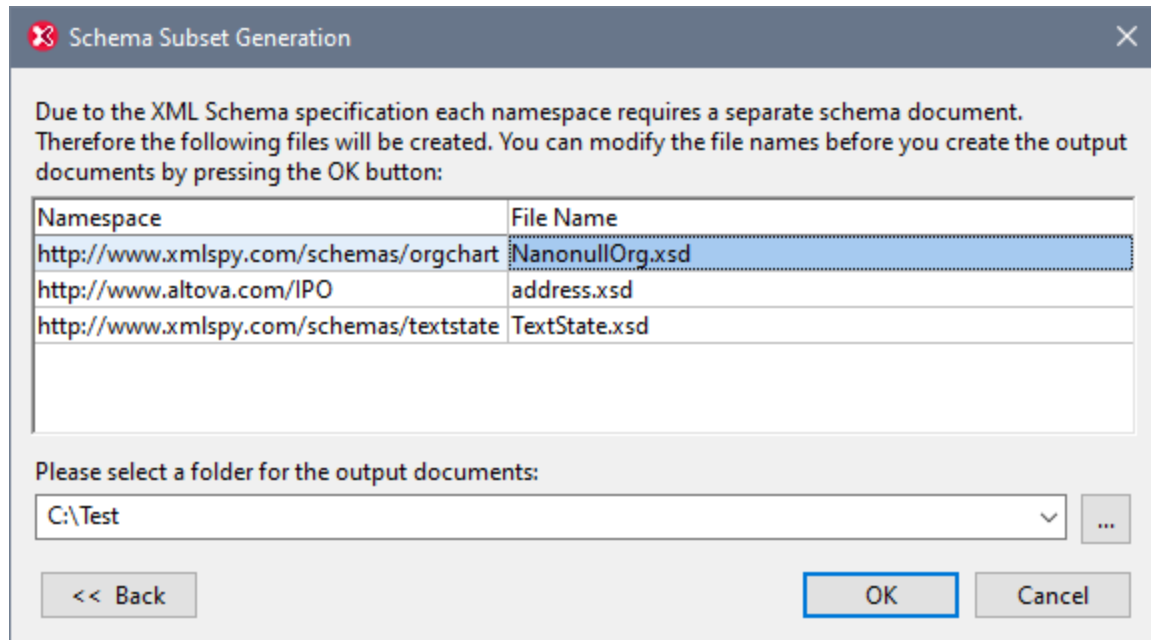

4. On clicking **OK**, the schema subset file with the namespace corresponding to that of the active file is opened in Schema View. Any other files in the package are created but not opened in Schema View.

Flattening a schema

Flattening the active schema in Schema View is the process of: (i) adding the components of all included schemas as global components of the active schema, and (ii) deleting the included schemas.

To flatten the active schema, select the command **Schema Design | Flatten Schema**. This pops up the Flatten Schema dialog (*screenshot below*), which contains the names of separate files, one for each namespace that will be in the flattened schema. These default names are the same as the original filenames. But since you are not allowed to overwrite the original files, the filenames must be changed if you wish to save in the same folder as the active file. You can browse for a folder in which the flattened schema and its associated files will be saved.

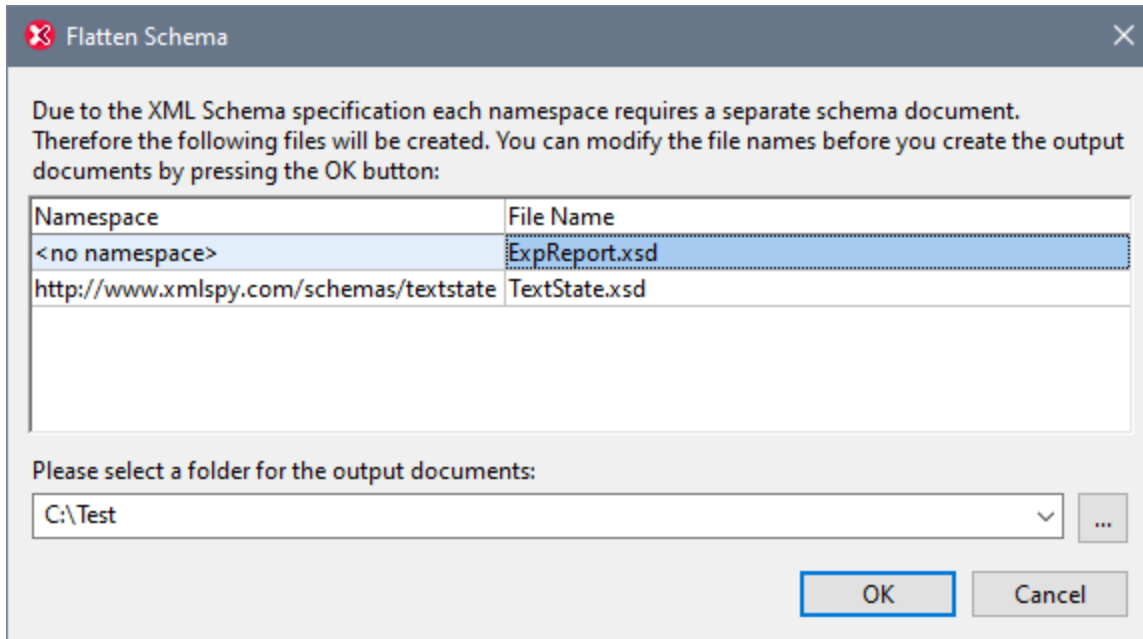

On clicking **OK**, the flattened schema file will be opened in Schema View.

6.5 Catalogs in XMLSpy

XMLSpy supports a subset of the OASIS XML catalogs mechanism. The catalog mechanism enables XMLSpy to retrieve commonly used schemas (as well as stylesheets and other files) from local user folders. This increases the overall processing speed, enables users to work offline (that is, not connected to a network), and improves the portability of documents (because URIs would then need to be changed only in the catalog files.)

The catalog mechanism in XMLSpy works as outlined in this section:

- [How Catalogs Work](#) ³³¹
- [Catalog Structure in XMLSpy](#) ³³²
- [Customizing Your Catalogs](#) ³³³
- [Environment Variables](#) ³³⁵

For more information on catalogs, see the [XML Catalogs specification](#).

6.5.1 How Catalogs Work

Catalogs can be used to redirect both DTDs and XML Schemas. While the concept behind the mechanisms of both cases is the same, the details are different and are explained below.

DTDs

Catalogs are commonly used to redirect a call to a DTD to a local URI. This is achieved by mapping, in the catalog file, public or system identifiers to the required local URI. So when the `DOCTYPE` declaration in an XML file is read, its public or system identifier locates the required local resource via the catalog file mapping.

For popular schemas, the `PUBLIC` identifier is usually pre-defined, thus requiring only that the URI in the catalog file map the `PUBLIC` identifier to the correct local copy. When the XML document is parsed, the `PUBLIC` identifier in it is read. If this identifier is found in a catalog file, then the corresponding URL in the catalog file will be looked up and the schema will be read from this location. So, for example, if the following SVG file is opened in XMLSpy:

```
<?xml version="1.0" standalone="no"?>
<!DOCTYPE svg PUBLIC "-//W3C//DTD SVG 1.1//EN"
"http://www.w3.org/Graphics/SVG/1.1/DTD/svg11.dtd">

<svg width="20" height="20" xml:space="preserve">
  <g style="fill:red; stroke:#000000">
    <rect x="0" y="0" width="15" height="15"/>
    <rect x="5" y="5" width="15" height="15"/>
  </g>
</svg>
```

The catalog is searched for the `PUBLIC` identifier of this SVG file. Let's say the catalog file contains the following entry:

```
<catalog>
  ...
```

```

    <public publicId "-//W3C//DTD SVG 1.1//EN" uri="schemas/svg/svg11.dtd"/>
    ...
</catalog>

```

In this case, there is a match for the `PUBLIC` identifier. As a result, the lookup for the SVG DTD is redirected to the URL `schemas/svg/svg11.dtd` (which is relative to the catalog file). This is a local file that will be used as the DTD for the SVG file. If there is no mapping for the `Public` ID in the catalog, then the URL in the XML document will be used (in the SVG file example above, this is the Internet URL: `http://www.w3.org/Graphics/SVG/1.1/DTD/svg11.dtd`).

XML Schemas

In XMLSpy, you can also use catalogs with **XML Schemas**. In the XML instance file, the reference to the schema will occur in the `xsi:schemaLocation` attribute of the XML document's top-level element. For example,

```
xsi:schemaLocation="http://www.xmlspy.com/schemas/orgchart OrgChart.xsd"
```

The value of the `xsi:schemaLocation` attribute has two parts: a namespace part (green above) and a URI part (highlighted). The namespace part is used in the catalog to map to the alternative resource. For example, the following catalog entry redirects the schema reference above to a schema at an alternative location.

```
<uri name="http://www.xmlspy.com/schemas/orgchart" uri="C:\MySchemas\OrgChart.xsd"/>
```

Normally, the URI part of the `xsi:schemaLocation` attribute's value is a path to the actual schema location. However, if the schema is referenced via a catalog, the URI part need not point to an actual XML Schema but must exist so that the lexical validity of the `xsi:schemaLocation` attribute is maintained. A value of `foo`, for example, would be sufficient for the URI part of the attribute's value to be valid.

6.5.2 Catalog Structure in XMLSpy

When XMLSpy starts, it loads a file called `RootCatalog.xml` (structure shown in listing below), which contains a list of catalog files that will be looked up. You can modify this file and enter as many catalog files to look up as you like, each of which is referenced in a `nextCatalog` element. These catalog files are looked up and the URIs in them are resolved according to their mappings.

Listing of RootCatalog.xml

```

<?xml version="1.0" encoding="UTF-8"?>
<catalog xmlns="urn:oasis:names:tc:entity:xmlns:xml:catalog"
  xmlns:spy="http://www.altova.com/catalog_ext"
  xmlns:xsi="http://www.w3.org/2001/XMLSchema-instance"
  xsi:schemaLocation="urn:oasis:names:tc:entity:xmlns:xml:catalog Catalog.xsd">
  <nextCatalog catalog="%PersonalFolder%/Altova/%AppAndVersionName%/CustomCatalog.xml"/>
  <!-- Include all catalogs under common schemas folder on the first directory level -->
  <nextCatalog spy:recurseFrom="%CommonSchemasFolder%" catalog="catalog.xml"
spy:depth="1"/>
  <nextCatalog spy:recurseFrom="%ApplicationWritableDataFolder%/pkgs/.cache"
catalog="remapping.xml" spy:depth="0"/>
  <nextCatalog catalog="CoreCatalog.xml"/>
</catalog>

```

The listing above references a custom catalog (named `CustomCatalog.xml`) and a set of catalogs that locate commonly used schemas (such as W3C XML Schemas and the SVG schema).

- `CustomCatalog.xml` is located in your Personal Folder (located via the variable `%PersonalFolder%`). It is a skeleton file in which you can create your own mappings. You can add mappings to `CustomCatalog.xml` for any schema you require that is not addressed by the catalog files in the Common Schemas Folder. Do this by using the supported elements of the OASIS catalog mechanism (see next section).
- The Common Schemas Folder (located via the variable `%CommonSchemasFolder%`) contains a set of commonly used schemas. Inside each of these schema folders is a `catalog.xml` file that maps public and/or system identifiers to URIs that point to locally saved copies of the respective schemas.
- `CoreCatalog.xml` is located in the XMLSpy application folder, and is used to locate schemas and stylesheets used by XMLSpy-specific processes, such as StyleVision Power Stylesheets which are stylesheets used to generate Altova's Authentic View of XML documents.

Location variables

The variables that are used in `RootCatalog.xml` (listing above) have the following values:

<code>%PersonalFolder%</code>	Personal folder of the current user, for example <code>C:\Users\<<name>\Documents</code>
<code>%CommonSchemasFolder%</code>	<code>C:\ProgramData\Altova\Common2024\Schemas</code>
<code>%ApplicationWritableDataFolder%</code>	<code>C:\ProgramData\Altova</code>

Location of catalog files and schemas

Note the locations of the various catalog files.

- `RootCatalog.xml` and `CoreCatalog.xml` are in the XMLSpy application folder.
- `CustomCatalog.xml` is located in your `MyDocuments\Altova\XMLSpy` folder.
- The `catalog.xml` files are each in a specific schema folder, these schema folders being inside the Common Schemas Folder.

6.5.3 Customizing Your Catalogs

When creating entries in `CustomCatalog.xml` (or any other catalog file that is to be read by XMLSpy), use only the following elements of the OASIS catalog specification. Each of the elements below is listed with an explanation of their attribute values. For a more detailed explanation, see the [XML Catalogs specification](#). Note that each element can take the `xml:base` attribute, which is used to specify the base URI of that element.

- `<public publicId="PublicID of Resource" uri="URL of local file"/>`
- `<system systemId="SystemID of Resource" uri="URL of local file"/>`
- `<uri name="filename" uri="URL of file identified by filename"/>`
- `<rewriteURI uriStartString="StartString of URI to rewrite" rewritePrefix="String to replace StartString"/>`
- `<rewriteSystem systemIdStartString="StartString of SystemID"/>`

```
rewritePrefix="Replacement string to locate resource locally"/>
```

Note the following points:

- In cases where there is no public identifier, as with most stylesheets, the system identifier can be directly mapped to a URL via the `system` element.
- A URI can be mapped to another URI using the `uri` element.
- The `rewriteURI` and `rewriteSystem` elements enable the rewriting of the starting part of a URI or system identifier, respectively. This allows the start of a filepath to be replaced and consequently enables the targeting of another directory. For more information on these elements, see the [XML Catalogs specification](#).

From release 2014 onwards, XMLSpy adheres closely to the [XML Catalogs specification \(OASIS Standard V1.1, 7 October 2005\)](#) specification. This specification strictly separates external-identifier look-ups (those with a Public ID or System ID) from URI look-ups (URIs that are not Public IDs or System IDs). Namespace URIs must therefore be considered simply URIs—not Public IDs or System IDs—and must be used as URI look-ups rather than external-identifier look-ups. In XMLSpy versions prior to version 2014, schema namespace URIs were translated through `<public>` mappings. From version 2014 onwards, `<uri>` mappings have to be used.

```
Prior to v2014: <public publicID="http://www.MyMapping.com/ref"
uri="file:///C:/MyDocs/Catalog/test.xsd"/>
V-2014 onwards: <uri name="http://www.MyMapping.com/ref"
uri="file:///C:/MyDocs/Catalog/test.xsd"/>
```

How XMLSpy finds a referenced schema

A schema is referenced in an XML document via the `xsi:schemaLocation` attribute (*shown below*). The value of the `xsi:schemaLocation` attribute has two parts: a namespace part (green) and a URI part (highlighted).

```
xsi:schemaLocation="http://www.xmlspy.com/schemas/orgchart OrgChart.xsd"
```

Given below are the steps, followed sequentially by XMLSpy, to find a referenced schema. The schema is loaded at the first successful step.

1. Look up the catalog for the URI part of the `xsi:schemaLocation` value. If a mapping is found, including in `rewriteURI` mappings, use the resulting URI for schema loading.
2. Look up the catalog for the namespace part of the `xsi:schemaLocation` value. If a mapping is found, including in `rewriteURI` mappings, use the resulting URI for schema loading.
3. Use the URI part of the `xsi:schemaLocation` value for schema loading.

File extensions and intelligent editing according to a schema

Via catalog files you can also specify that documents with a particular file extension should have XMLSpy's intelligent editing features applied in conformance with the rules in a schema you specify. For example, if you create a custom file extension `.myhtml` for (HTML) files that are to be valid according to the HTML DTD, then you can enable intelligent editing for files with these extensions by adding the following element of text to `CustomCatalog.xml` as a child of the `<catalog>` element.

```
<catalog>
...
<spy:fileExtHelper ext="myhtml" uri="schemas/xhtml/xhtml1-transitional.dtd"/>
...
```

```
</catalog>
```

This would enable intelligent editing (auto-completion, entry helpers, etc) of `.myhtml` files in XMLSpy according to the XHTML 1.0 Transitional DTD. Refer to the `catalog.xml` file in the `%AltovaCommonSchemasFolder%\Schemas\xhtml` folder, which contains similar entries.

XML Schema specifications

XML Schema specification information is built into XMLSpy and the validity of XML Schema (`.xsd`) documents is checked against this internal information. In an XML Schema document, therefore, no references should be made to any schema that defines the XML Schema specification.

The `catalog.xml` file in the `%AltovaCommonSchemasFolder%\Schemas\schema` folder contains references to DTDs that implement older XML Schema specifications. You should not validate your XML Schema documents against these schemas. The referenced files are included solely to provide XMLSpy with entry helper info for editing purposes should you wish to create documents according to these older recommendations.

6.5.4 Environment Variables

Shell environment variables can be used in the `nextCatalog` element to specify the path to various system locations (see *RootCatalog.xml listing above*). The following shell environment variables are supported:

<code>%PersonalFolder%</code>	Full path to the Personal folder of the current user, for example <code>c:\Users\<name>\Documents</name></code>
<code>%CommonSchemasFolder%</code>	<code>C:\ProgramData\Altova\Common2024\Schemas</code>
<code>%ApplicationWritabledataFolder%</code>	<code>C:\ProgramData\Altova</code>
<code>%AltovaCommonFolder%</code>	<code>C:\Program Files\Altova\Common2024</code>
<code>%DesktopFolder%</code>	Full path to the Desktop folder of the current user.
<code>%ProgramMenuFolder%</code>	Full path to the Program Menu folder of the current user.
<code>%StartMenuFolder%</code>	Full path to Start Menu folder of the current user.
<code>%StartUpFolder%</code>	Full path to Start Up folder of the current user.
<code>%TemplateFolder%</code>	Full path to the Template folder of the current user.
<code>%AdminToolsFolder%</code>	Full path to the file system directory that stores administrative tools of the current user.
<code>%AppDataFolder%</code>	Full path to the Application Data folder of the current user.
<code>%CommonAppDataFolder%</code>	Full path to the file directory containing application data of all users.
<code>%FavoritesFolder%</code>	Full path of the Favorites folder of the current user.

<code>%PersonalFolder%</code>	Full path to the Personal folder of the current user.
<code>%SendToFolder%</code>	Full path to the SendTo folder of the current user.
<code>%FontsFolder%</code>	Full path to the System Fonts folder.
<code>%ProgramFilesFolder%</code>	Full path to the Program Files folder of the current user.
<code>%CommonFilesFolder%</code>	Full path to the Common Files folder of the current user.
<code>%WindowsFolder%</code>	Full path to the Windows folder of the current user.
<code>%SystemFolder%</code>	Full path to the System folder of the current user.
<code>%LocalAppDataFolder%</code>	Full path to the file system directory that serves as the data repository for local (nonroaming) applications.
<code>%MyPicturesFolder%</code>	Full path to the MyPictures folder.

6.6 Working with SchemaAgent

XMLSpy can be set up to work with Altova's SchemaAgent technology.

SchemaAgent technology

The SchemaAgent technology enables users to build and edit relationships between multiple schemas. It consists of:

- A SchemaAgent Server, which holds and serves information about the relationships among schemas in one or more search path/s (folder/s on the network) that you specify.
- A SchemaAgent client, Altova's SchemaAgent product, which uses schema information from the SchemaAgent server to which it is connected (i) to build relationships between these schemas; and (ii) to manage these schemas (rename, move, delete schemas, etc).

Two types of SchemaAgent server are available:

- Altova SchemaAgent Server, which can be installed on, and accessed from, a network, and
- Altova SchemaAgent, which is the SchemaAgent client product. It includes a lighter server version, called LocalServer, which can only be used on the same machine on which SchemaAgent is installed.

XMLSpy uses SchemaAgent technology to directly edit schemas in Schema View using information about other schemas it gets from a SchemaAgent server. In this setup, XMLSpy is connected to a SchemaAgent server, and, in interaction with SchemaAgent Client, sends requests to SchemaAgent Server. When XMLSpy has been set up to work with SchemaAgent, the Entry Helpers in Schema View not only list components from the schema currently active in Schema View but also list components from other schemas in the search paths of the SchemaAgent server to which it is connected. This provides you with direct access to these components. You can view the content model of a component belonging to another schema in Schema View, and reuse this component with or without modifications. You can also build relationships between schemas, thereby enabling you to modularize and manage complex schemas directly from within XMLSpy.

Installing SchemaAgent and SchemaAgent Server

For details about installing SchemaAgent and SchemaAgent Server and configuring search paths on servers, see the SchemaAgent user manual.

Setting up XMLSpy as a SchemaAgent client

In order for XMLSpy to work as a SchemaAgent client, you must do the following:

- Download SchemaAgent from the [Altova website](#). You can now use SchemaAgent's LocalServer to serve schemas. For information about configuring search paths on LocalServer, see the SchemaAgent user manual.
Please note: SchemaAgent requires a valid license, which must be purchased after the free trial period runs out. Also note that the Altova MissionKit product package, Enterprise Edition, includes the SchemaAgent product and a license key for it. (The SchemaAgent Server application, however, is not included in Altova MissionKit packages.)
- Additionally, you might want to download and install the network-based SchemaAgent Server from the [Altova website](#).
- Define the search path(s) for SchemaAgent server (also known as configuring SchemaAgent Server). A detailed description of how to do this is given in the SchemaAgent user manual. (A search path is a

path to the folder containing the XML schemas that will be mapped for their relationships with each other.)

- Start a connection from within XMLSpy to a SchemaAgent server.

Important: All SchemaAgent and SchemaAgent-related products from Altova (including XMLSpy) starting with Version 2005 release 3 are **not compatible** with previous versions of SchemaAgent or SchemaAgent-related products.

SchemaAgent commands in XMLSpy

The SchemaAgent functionality in XMLSpy is available only in Schema View and is accessed via menu commands in the Schema Design menu (see *screenshot*) and by using the Entry Helpers in Schema View.

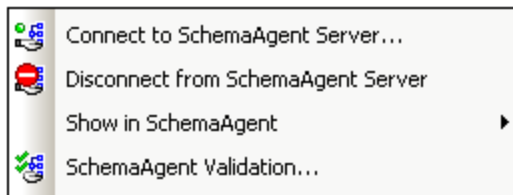

The menu commands provide general administrative functionality. The Entry Helpers (and standard GUI mechanisms, such as drag-and-drop) are used to actually edit schemas.

This section describes how to use the SchemaAgent functionality available in Schema View.

6.6.1 Connecting to SchemaAgent Server

Please note: SchemaAgent Client must be installed in order for you to be able to make a connection.

Before you connect to SchemaAgent Server, only the **Connect to SchemaAgent Server** command is enabled in the **Schema Design** menu; other SchemaAgent commands in the **Schema Design** menu are disabled (see *screenshot*). The other menu items become enabled once a connection to a SchemaAgent Server has been successfully made.

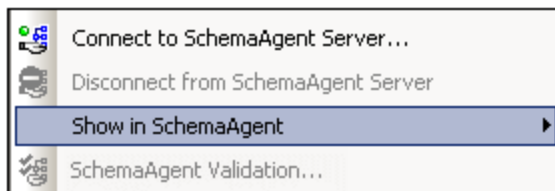

Connection steps

To connect to a SchemaAgent server:

1. Click the Connect to SchemaAgent server toolbar icon  (**Schema Design | Connect to SchemaAgent Server**). The Connect to SchemaAgent Server dialog (*screenshot below*) opens:

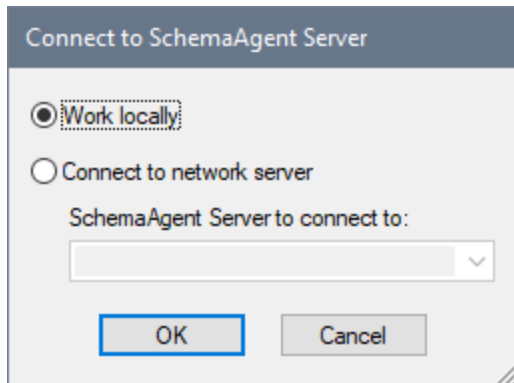

2. You can use either the local server (the SchemaAgent server that is packaged with Altova SchemaAgent) or a network server (the Altova SchemaAgent Server product, which is available free of charge). If you select Work Locally, the local server of SchemaAgent will be started when you click **OK** and a connection to it will be established. If you select Connect to Network Server, the selected SchemaAgent Server must be running in order for a connection to be made.

Note on servers running with Windows XP SP2

If the SchemaAgent Server name is listed in the Connect to SchemaAgent Server dialog but you cannot connect to it, it is possible that your server is not taking part in the name resolution process of your network. Name resolution is blocked by the default settings of the Windows XP SP2 Firewall.

To connect to such a server, do one of the following:

- Change the server settings to enable the name resolution process, or
- Enter the IP address of the server in the Edit field of the Connect Dialog box.

This need be done only once as SchemaAgent Client stores the connection string of the last successful connection.

Schema View after connecting to SchemaAgent server

After a connection to a SchemaAgent server is established, Schema View will look something like this:

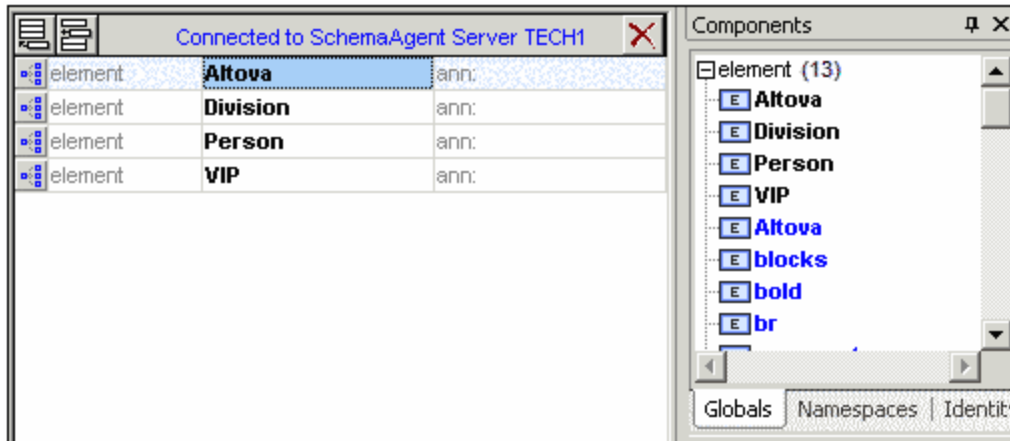

Please note:

- At the top of the Globals view the text "Connected to SchemaAgent Server" appears, specifying the server to which the connection has been made.
- You now have full access to all schemas and schema constructs available in the server search path. SchemaAgent schema constructs such as global elements, complexTypes, and simpleTypes are visible in **bold blue text**, below the constructs of the active schema (**bold black text**).

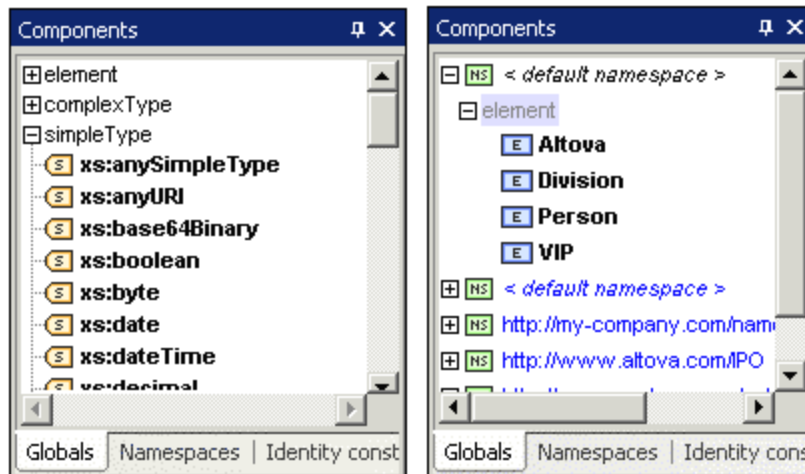

Schema constructs can be viewed by Type (Globals), by Namespace, or by Identity Constraints in the respective tabs of the Components entry helper.

6.6.2 Opening Schemas Found in the Search Path

This example demonstrates how to open a schema found in a search path defined in SchemaAgent Server. It uses the DB2schema.xsd file available in the ..\Tutorial folder as the active schema. The Global tab of the Components entry helper is active.

1. Scroll down to the blue `Company` entry in the Components entry helper, and double-click it. The Goto Definition dialog box is opened.

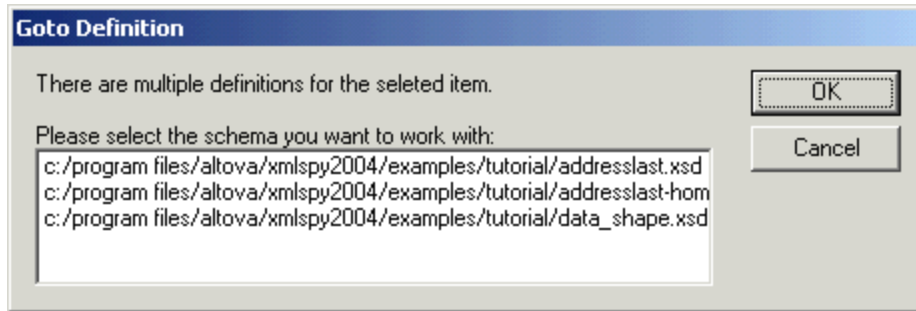

2. Click the `Addresslast.xsd` entry, and click **OK** to confirm. This opens the `addresslast.xsd` schema and displays the content model of the `Company` element.

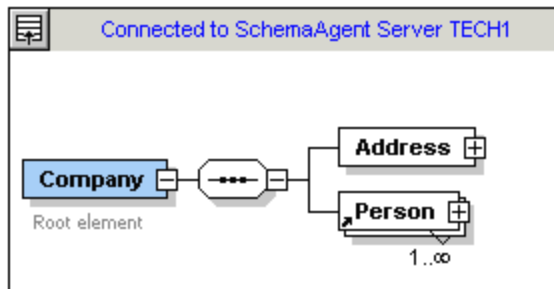

Please note: Double-clicking a SchemaAgent schema construct, such as Element, complexType, or simpleType, opens the associated schema (as well as all other included schemas) in XMLSpy.

6.6.3 Using IIRs

XML schema provides Import, Include, and Redefine (IIR) statements to help modularize schemas. Each method has different namespace requirements. These requirements are automatically checked by SchemaAgent Client and XMLSpy when you try to create IIRs.

Imports, Includes, and Redefines (IIRs)

Schema constructs can be "inserted" by different methods:

- Global elements can be dragged directly from the Components Entry Helper into the content model of a schema component (in Schema View).
- Components, such as complexTypes and simpleTypes, can be selected from the list box that automatically opens when defining new elements/attributes, etc.
- Components, such as complexTypes, can be selected from the Details Entry Helper when creating/updating these type of constructs.

Incorporating schema components

This example uses the `DB2schema.xsd` file available in the `..\Tutorial` folder as the active schema; the `Global` tab of the Components Entry Helper is active.

To use schema constructs from SchemaAgent Server schemas:

1. Make sure you are connected to a SchemaAgent server (see [Connecting to SchemaAgent server](#)³³⁸).
2. Open and rename the `DB2Schema.xsd` file for this example, for example to `Altova-office`.

Connected to SchemaAgent Server TECH1		
element	Altova	ann:
element	Division	ann:
element	Person	ann:
element	VIP	ann:

3. Click the  icon of the `Altova` element in the Schema Overview to see its content model.
4. Right-click the `Altova` sequence compositor and select the menu option **Add Child | Element**. Note that a list box containing all global elements within the server path opens automatically at this point. Selecting one would incorporate that element.

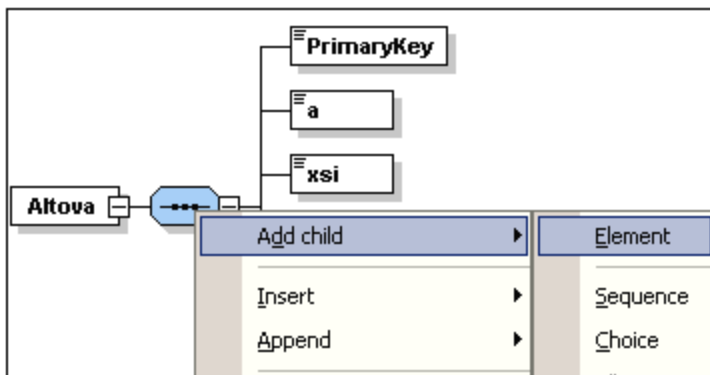

5. Enter `Altova-office` as the name for this new element and press **Enter**.
6. Using the Details Entry Helper, click the `type` combo box and select the entry `OfficeType`.

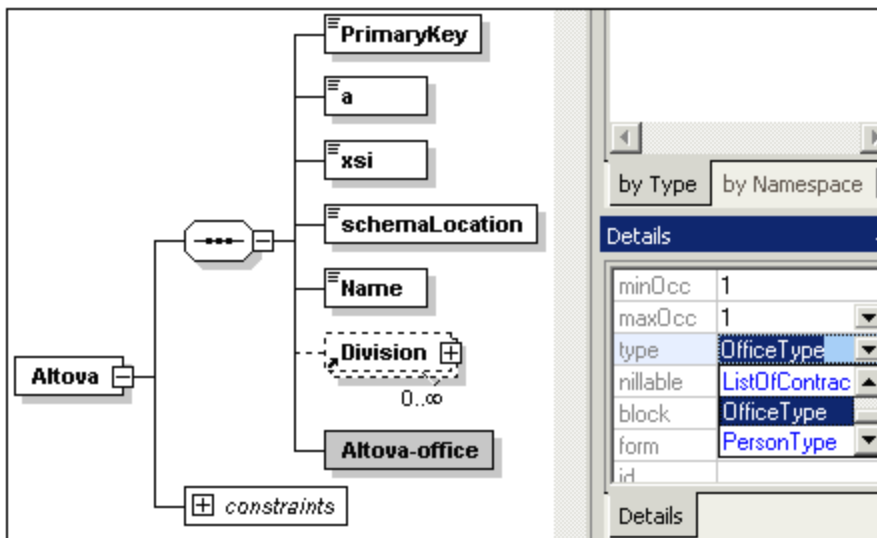

This opens the Select Definition For OfficeType dialog box.

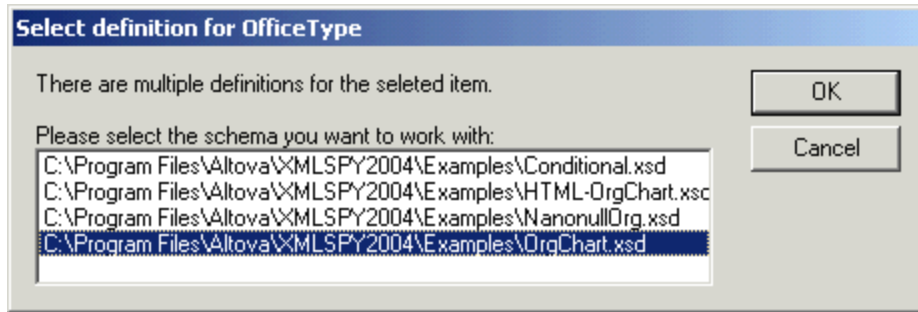

7. Select `Orgchart.xsd` and click **OK** to confirm.

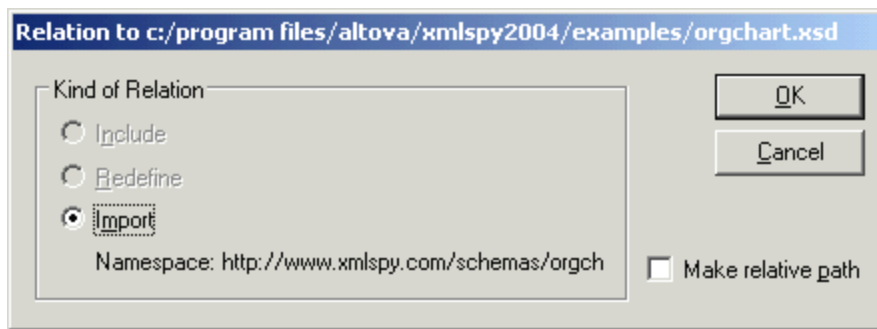

8. Click **OK**. The Import command was automatically selected for you. An expand icon appears in the `Altova-office` element.



Please note: The `type` entry in the Details entry helper has changed; it is now displayed as `ns1:OfficeType` due to the fact that the `Orgchart.xsd` schema file has been imported and the target namespaces must be different in both schemas. An Import command has also been added to the schema.

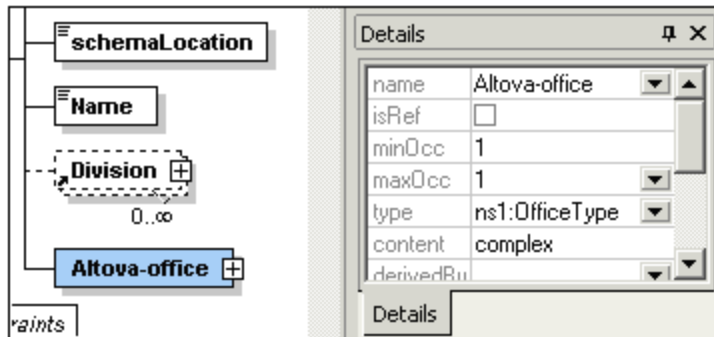

9. Click the Expand button to see the `OfficeType` content model.

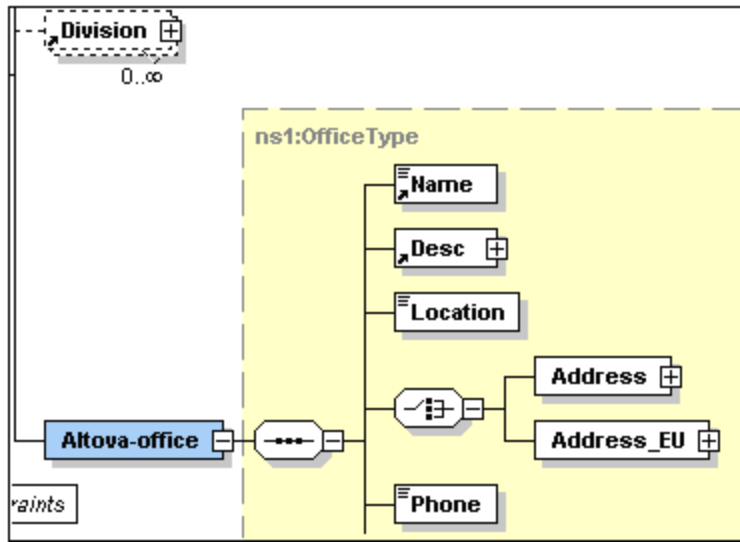

10. Press **F8** to validate the schema. The "Schema is valid" message should appear at this stage.

Cleaning up the schema:

1. Delete the `Division` element in the content model.
2. Click the Return to globals icon  to switch to the Schema Overview.
3. Delete the following global elements: `Division`, `Person` and `VIP`.

Connected to SchemaAgent Server TECH1		
import	loc:c:\program files\altova\xml	ns:http://www.xmlspy.com/sc
element	Altova	ann:
element	Altova-office	ann:

4. Select the menu option **Schema Design | Schema settings** to see how the namespace settings have changed.

No target namespace
 Target namespace:

Prefix	Namespace
xs	http://www.w3.org/2001/XMLSchema
ns1	http://www.xmlspy.com/schemas/orgchart

The `ns1` prefix has been automatically added to the `www.xmlspy.com/schemas/orgchart` namespace. The Components (see *screenshot*) and Details Entry Helpers displays all imported constructs with the `ns1:` namespace prefix.

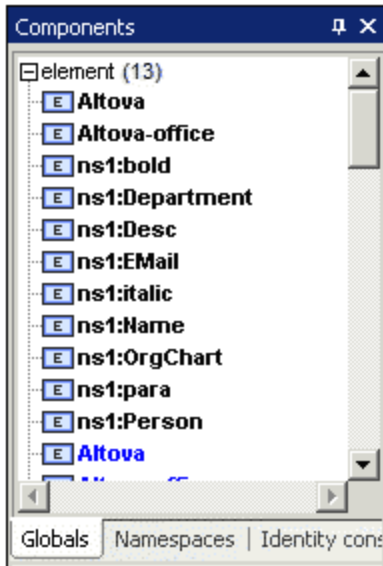
**Please note:**

- Changes made to schemas under SchemaAgent Server control using XMLSpy automatically update other schemas in the SchemaAgent Server path that referenced the changed schema.
- It is possible to see duplicates of constructs element, simpleTypes etc. in entry helpers (in black and blue), if the schema you are working on is also in the SchemaAgent Server path.

6.6.4 Viewing Schemas in SchemaAgent

To work with the active schema and its related schemas in SchemaAgent, select the menu option **Schema Design | Show in SchemaAgent | schema or related schemas** (see screenshot).

You have the option of opening only the active schema in SchemaAgent (**File only** command), or the active schema together with either (i) all directly referenced schemas, or (ii) all directly referencing schemas, or (iii) all directly related schemas.

6.6.5 SchemaAgent Validation

XMLSpy, in conjunction with SchemaAgent, allows you to validate not only the currently active schema but also schemas related to the currently active schema. We call this SchemaAgent validation. There are two types of related schemas that SchemaAgent distinguishes for extended validation: (i) directly dependent schemas (directly referenced and directly referencing schemas), and (ii) all dependent schemas (in addition to direct dependencies, these include indirect dependencies, which is the set of schemas that are related to another schema via an intermediary schema).

How to carry out SchemaAgent validation is demonstrated below by means of an example. This example assumes that the schema file `address.xsd` is the active schema in Schema View of XMLSpy. For the **SchemaAgent Validation** command to be enabled, make sure that the search paths on SchemaAgent Server contain the active file and some dependent files. Then do the following:

1. Click the **SchemaAgent Validation** icon  in the toolbar or the menu item **Schema Design | SchemaAgent Validation**. This opens the SchemaAgent Validation dialog box (*screenshot below*), in which you can choose whether to validate the active schema only or one or more related schemas as well.

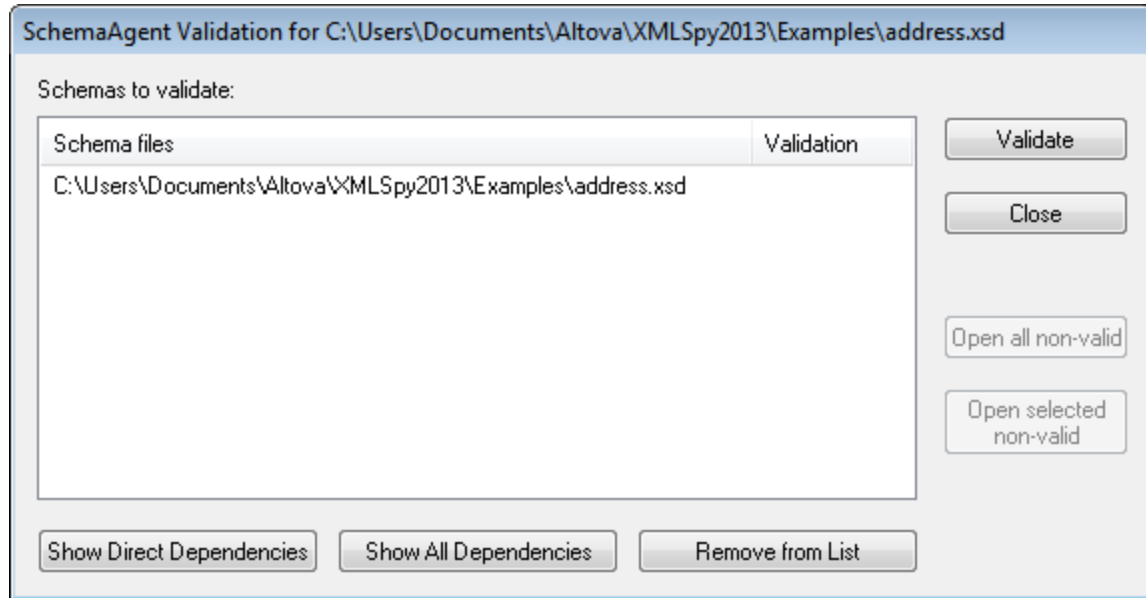

2. To insert schemas into the list, click the **Show Direct Dependencies** or **Show All Dependencies** button as required. In this example, we have clicked the **Show All Dependencies** button, and this inserts all files that are directly referenced or indirectly referenced into the list.

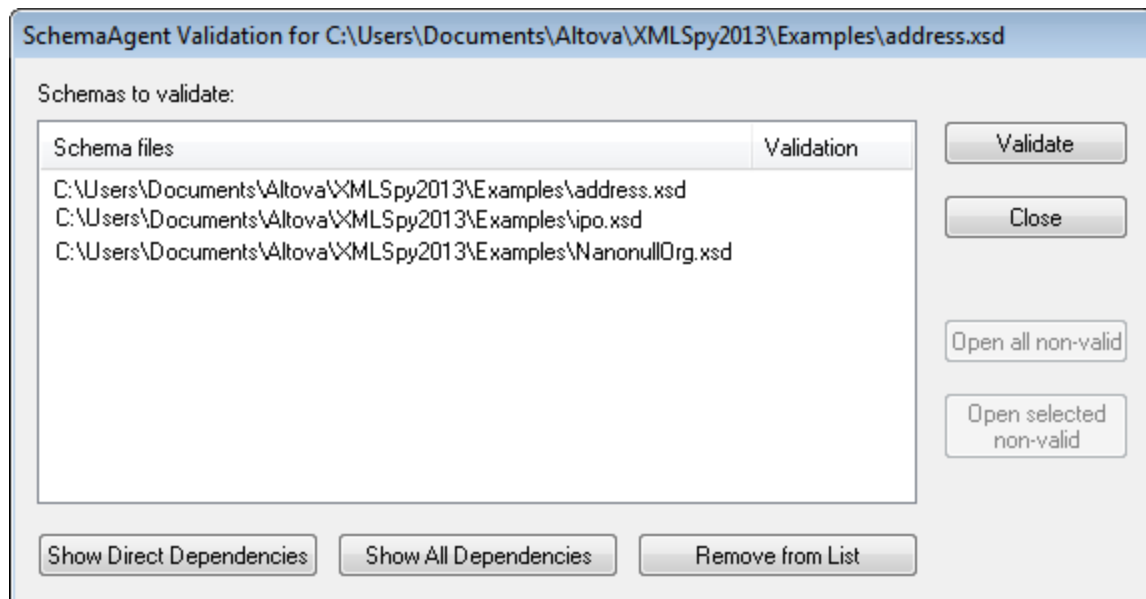

At this point, you can remove a schema from the list (**Remove from List**) if you wish to.

3. Click the **Validate** button to validate all the schemas in the list box.

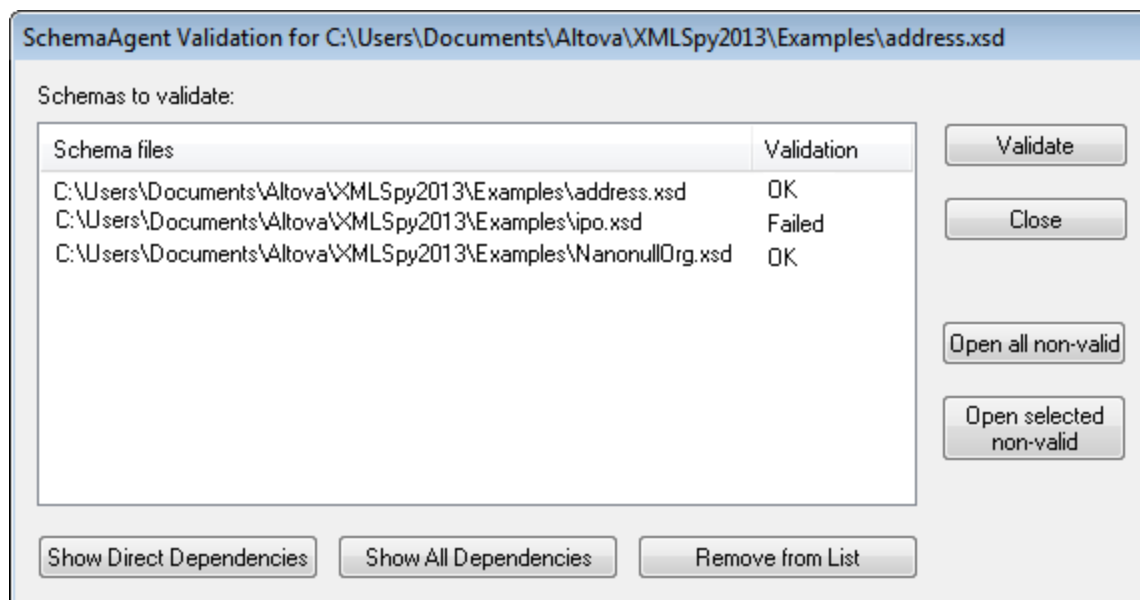

The Validate column displays whether the validation was successful or whether it failed.

You can now open all the non-valid schemas or a set of selected non-valid schemas in XMLSpy.

6.7 Find in Schemas

In Schema View, XML Schemas can be searched intelligently using XMLSpy's Find & Replace in Schema View feature.

The Find and Replace in Schema View feature is enabled when a schema is active in Schema View. It is accessed in one of two ways:

- Via the **Edit | Find** and **Edit | Replace** menu commands.
- Via the **Find** and **Replace** buttons in the Find in Schemas window.

Clicking a command or a button pops up the Find or the Replace dialog, according to which command/button was clicked. The Replace dialog (*screenshots below*) is different from the Find dialog in that it has a text entry field for the Replace term.

The standard Replace dialog looks like this:

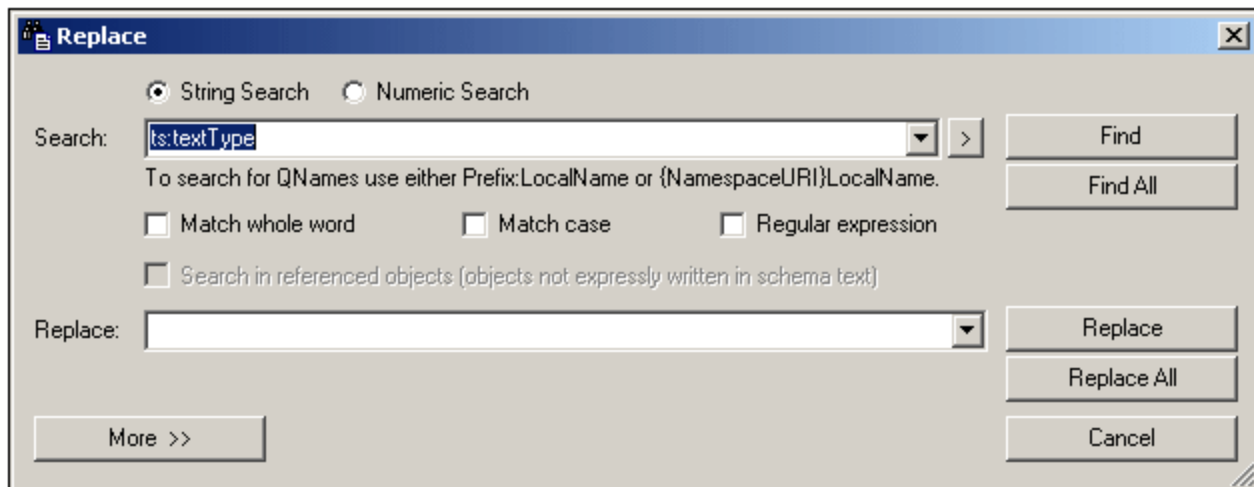

Clicking the **More** button expands the dialog to show additional search criteria (*screenshot below*).

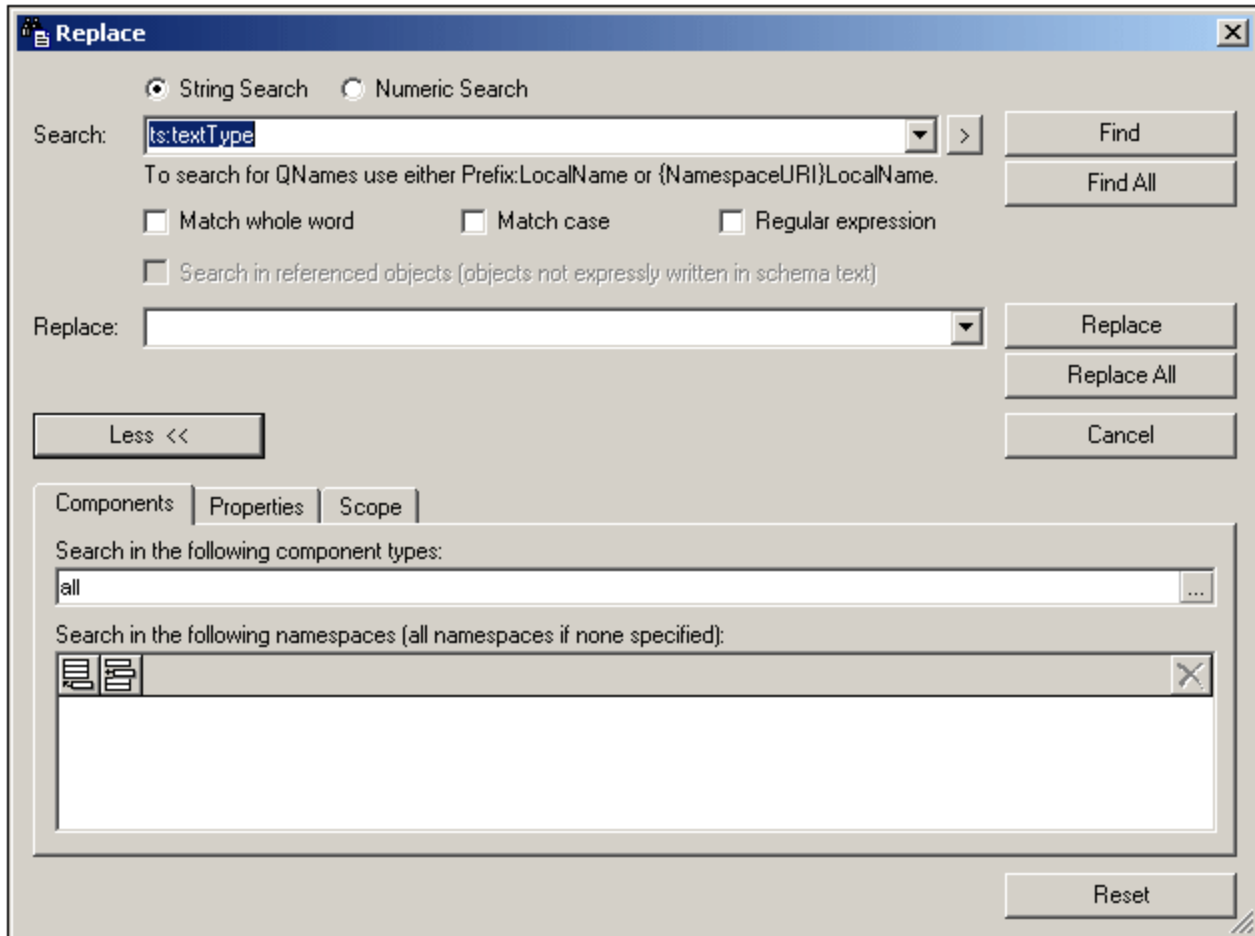

Usage is as follows:

- [Enter the search and replace terms](#) ³⁵⁰ in the Search and Replace text fields
- [Specify the schema components to be searched](#) ³⁵¹ in the Components tab
- [Specify the properties of the components to be searched](#) ³⁵³; this helps to narrow the search
- [Set the scope of the search](#) ³⁵⁶ to the current document or project, or specify a folder to search
- [Execute the command](#) ³⁵⁷
- [Use the Find in Schemas window](#) ³⁵⁹ to navigate to a component quickly

The **Reset** button at the bottom of the dialog resets the original settings, which are as follows:

- No search term, no replace term
- Components: *all*
- Namespaces: none specified
- Property restrictions: *anywhere*
- Additional property restrictions: none
- Scope: current file

Note: Regular expressions are not supported in the Replace field.

6.7.1 Search Term

The search term can be entered as a string (select the **String** radio button) or as a number (**Numeric** radio button).

String search

In a string search (*screenshot below*), the entry can be: (i) text; (ii) a QName; or (iii) a regular expression. For QName searches, the namespace is determined on the basis of either the prefix used in the document or by the namespace URI, either of which must be entered. In the screenshot below, the `ts:` prefix is the prefix used in the document to identify a certain namespace.

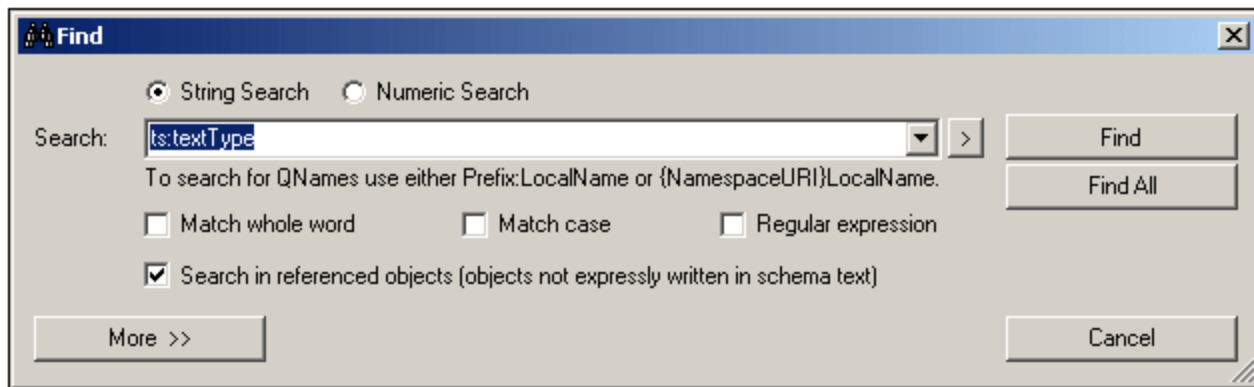

To search using a regular expression, check the Regular Expression check box and then enter the regular expression. Entry helpers for regular expressions are available in a menu that is activated by clicking the right-pointing arrowhead at the right of the Search entry field (*screenshot below*).

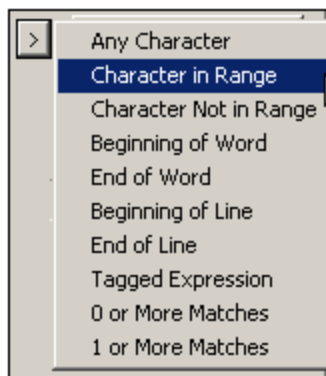

You can also select whether a search term must match a whole word in the document and/or whether the casing in the document must match. Use the check boxes below the text entry field to specify these options.

If you wish to search in referenced objects (such as a complexType definition or a global element), then check the Search In Referenced Objects check box. This option is available only in the Find dialog; it is disabled in the Replace dialog.

Numeric search

When the Numeric Search radio button is selected, the search term can be a single operator-and-number search parameter, or a set of two such operator-and-number search parameters joined by the logical connector AND or OR. In the screenshot below, there are two search term parameters which create a search term for all integers between, and including, 1 and 5.

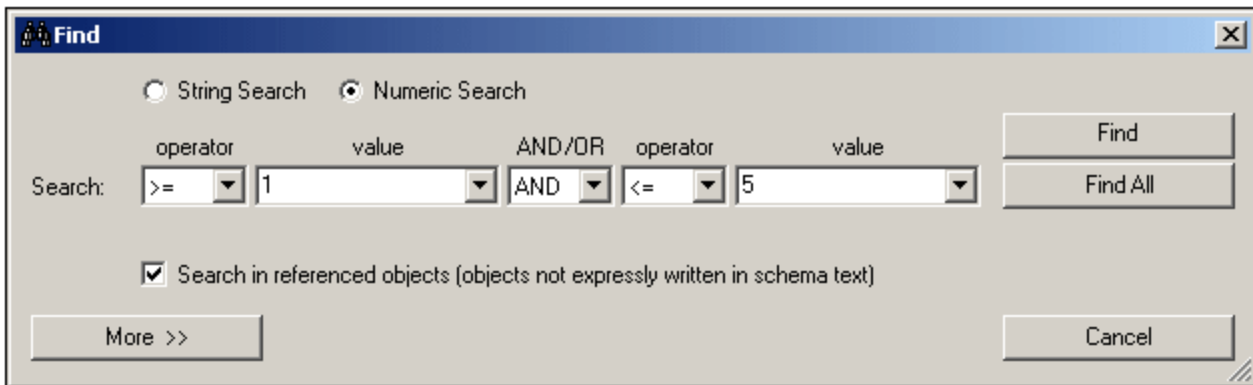

6.7.2 Components

The search can be restricted to one or more component types and to one or more target namespaces. These options are available in the Components tab. Expand the Find or Replace dialog by clicking the **More** button. This will bring up the tabs for refining the search, one of which is the Components tab (*screenshot below*).

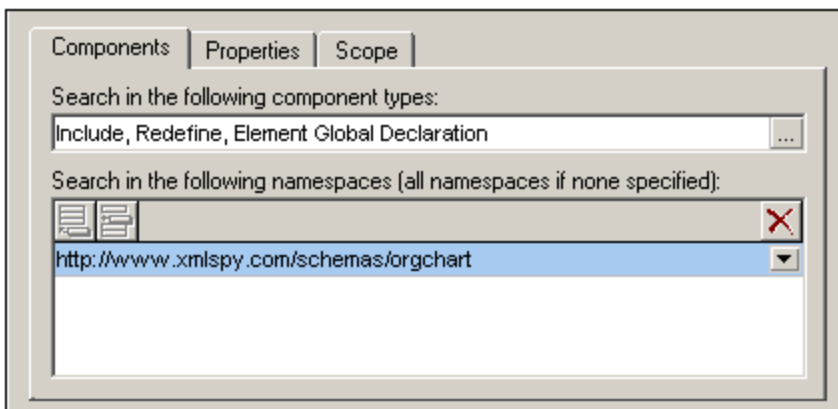

The Components tab consists of two parts: (i) for selecting the component types to be searched, and (ii) for selecting the target namespaces to be searched.

Component selection

You can enter the component types to be searched by clicking the **Add** icon  located to the right of the text field (see *screenshot above*). This pops up the Component Restriction dialog (*screenshot below*), in which you

can select the components to be searched by checking them. Checking the `Components` item at the top of the list selects all components (text entry: `all`). Unchecking it de-selects all components (text entry: `none`)—including individually selected components. Individual components, therefore, can be selected only when the `Components` item is unchecked. The selected components are entered in the text field as a comma-separated list (see screenshot above).

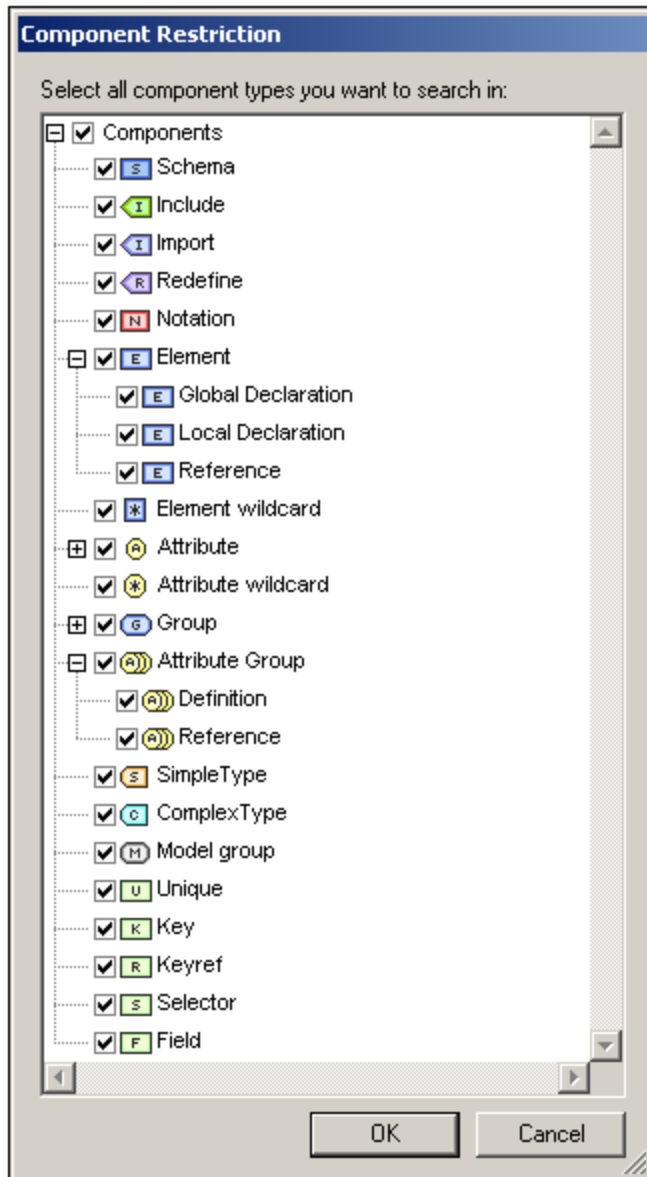

Note: Each time the Components tab or the Find/Replace dialog is opened, the previous component selection is retained.

Namespace selection

To select one or more target namespaces to be searched, click the **Add** or **Insert** icons and enter the required namespace/s. If no target namespace is specified, then all target namespaces are searched. To delete a target namespace that has been entered in this pane, select the target namespace and click the **Delete** icon.

6.7.3 Properties

The search can be restricted to one or more component properties (details and facets) by using options in the Properties tab, as well as to match the contents of properties. Expand the Find or Replace dialog by clicking the **More** button, and then select the Properties tab (*screenshot below*).

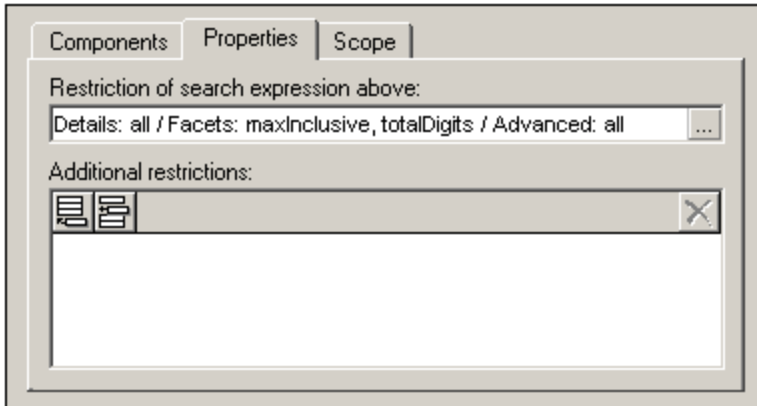

The Properties tab consists of two parts: (i) for restricting the main search term (entered in the Find text box); and (ii) for adding additional content restrictions (which have their own match term); see the section [Additional Restrictions](#)³⁵⁴ below.

Properties selection

You can enter the property types to be searched by clicking the **Add** icon , which is to the right of the text field (see *screenshot above*). This pops up the Property Restriction dialog (*screenshot below*), in which you can select the properties to be searched by checking them. The properties are organized in three groups: (i) Details; (ii) Facets; (iii) Advanced (such as the DerivedFrom property). Checking Details, Facets, or Advanced selects all properties in that group. Unchecking a group de-selects all properties in that group, including individually selected properties. Individual properties, therefore, can be selected only when the group item is unchecked. The selected properties are entered in the text field (see *screenshot above*).

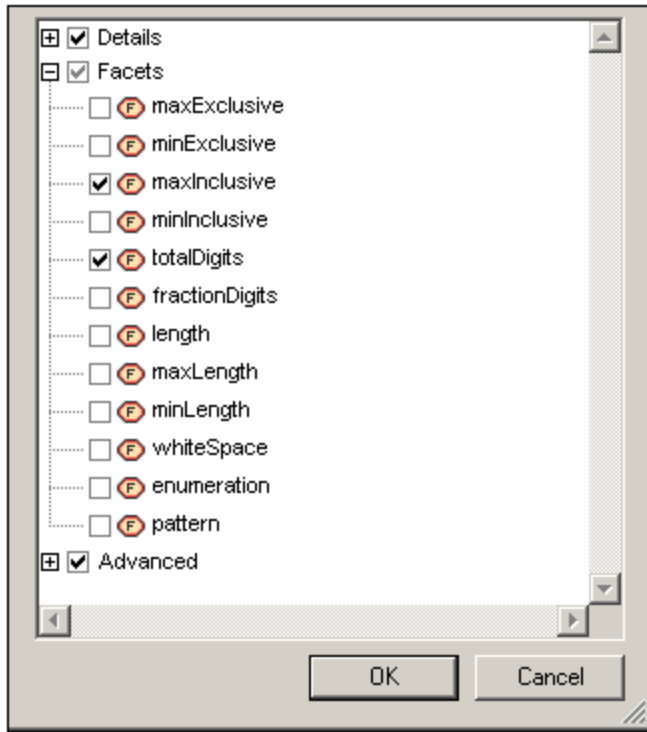

Note: Each time the Properties tab or the Find/Replace dialog is opened, the previous properties selection is retained.

Additional restrictions

An additional restriction enables you to specify the value of the property to search for. For example, if you are looking for an element called `state` which has an enumeration `MA` (for the US state of Massachusetts), you could specify the value `MA` of the property `enumeration` with the Addition Restrictions option. You would do this as follows:

1. In the Additional Restrictions pane, click the the **Add** or **Insert** icon (*screenshot below*).

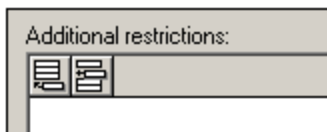

2. This adds a row to the pane and pops up the Property Restriction dialog. Deselect all properties and select only the `enumeration` property (*screenshot below*).

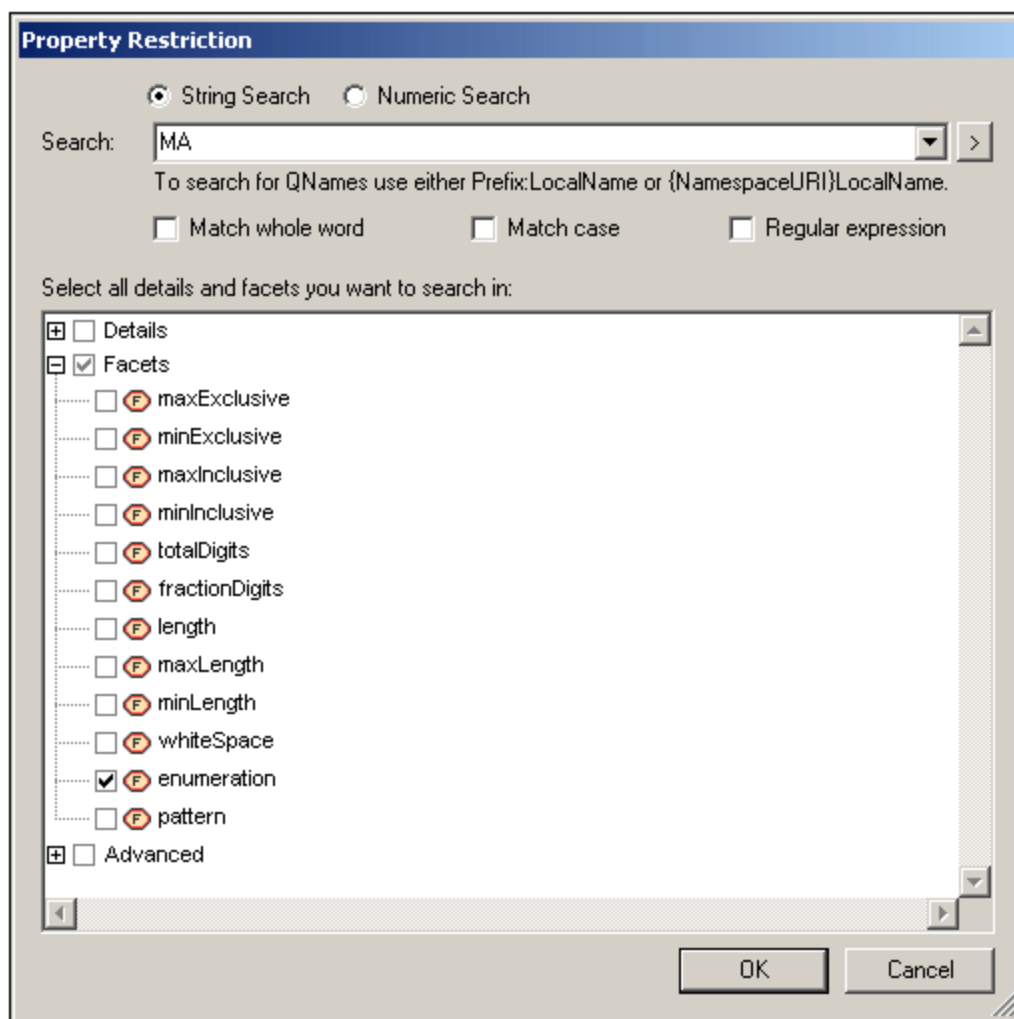

3. In the text field at the top of the dialog, enter the enumeration value to be searched for, in this case, `MA` (see screenshot above).
4. Click **OK**. The additional restriction is entered in the newly created row in the Additional Restrictions pane (screenshot below).

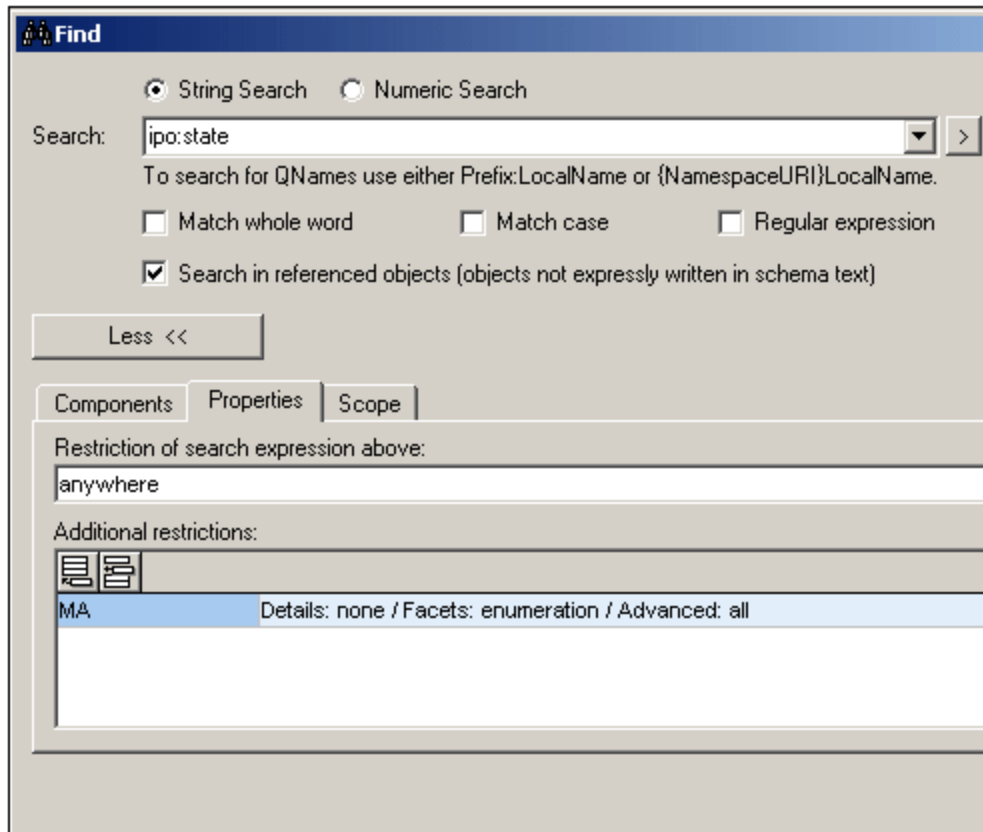

In the screenshot above, notice that the search term is `ipo:state`. In the Properties tab, the `anywhere` specifies that all properties will be searched, but the additional restriction specifies that the search should be restricted to enumerations having a value of `MA`.

Multiple additional restrictions can be added to further narrow the search. To delete an additional restriction, select the additional restriction and click the **Delete** icon.

Note: Each time the Properties tab or the Find/Replace dialog is opened, the previous additional restriction/s are retained.

6.7.4 Scope

The scope of the search can be set in the Scope tab (*screenshot below*). You can select either file/s or the currently selected schema component in Schema View.

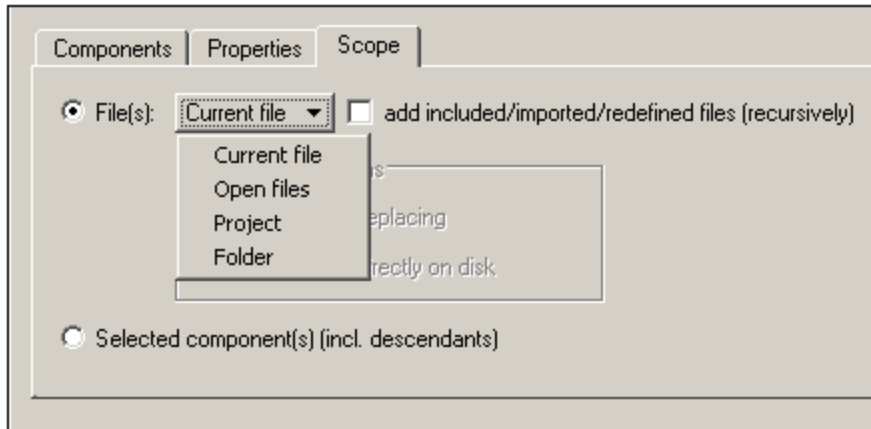

If the File/s option is selected, you can further specify one from among the following options:

- *Current file*: An additional option to search included, imported and redefined files is also available.
- *Open files*: All XML Schema (XSD) files that are open in XMLSpy. Only the Find All and Replace All commands are enabled; single-step searching is not available.
- *Project*: The currently active project is selected, with the option to skip external folders. Only the Find All and Replace All commands are enabled; single-step searching is not available. If the default view for the `.xsd` file extension (**Tools | Options | File Types | Default View**) is not Schema View, then the `.xsd` files are not searched.
- *Folder*: You can browse for the required folder; an option to search sub-folders is also available. Only the Find All and Replace All commands are enabled; single-step searching is not available. If the default view for the `.xsd` file extension (**Tools | Options | File Types | Default View**) is not Schema View, then the `.xsd` files are not searched.
- *Included, imported, and redefined files* can be included in the scope by checking the option for adding them to the scope.

In the Replace dialog, you can choose whether to copy the replacement to the file on disk or whether to open the file in XMLSpy. Do this by selecting the appropriate button in the dialog.

6.7.5 Find and Replace Commands

The **Find** command behaves differently in the Find and Replace dialogs. The behavior of the **Find** command in both dialogs and of the **Replace** command is described below.

Find dialog

After you have entered the search term and, optionally, other criteria to refine the search, you can click either the **Find (F3)** or **Find All** command (*screenshot below*).

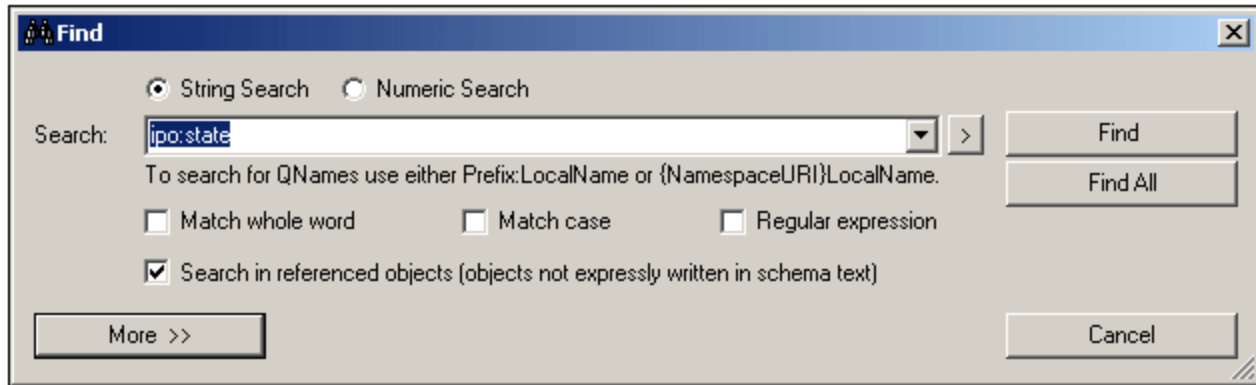

Clicking the **Find (Ctrl+F)** command in the dialog closes the Find dialog and finds the next occurrence of the search term within the specified scope and refinement criteria. The next occurrence is found relative to the currently selected component in Schema View. If the search reaches the end of the scope, it will not start automatically from the beginning of the scope. Therefore, you should make sure that the currently selected component in Schema View before starting the search is located before the document part you wish to search.

The result of the **Find** is highlighted in Schema View and the result is also reported in the Find In Schemas window. In the Find In Schemas window, you can click a result to highlight that item in Schema View.

Clicking the **Find All** command closes the Find dialog and lists all the search results in the Find In Schemas window.

Replace dialog

In the Replace dialog (*screenshot below*), clicking the **Find** command finds the next occurrence of the search term relative to the current selection in Schema View. You can then click **Replace** to replace this occurrence.

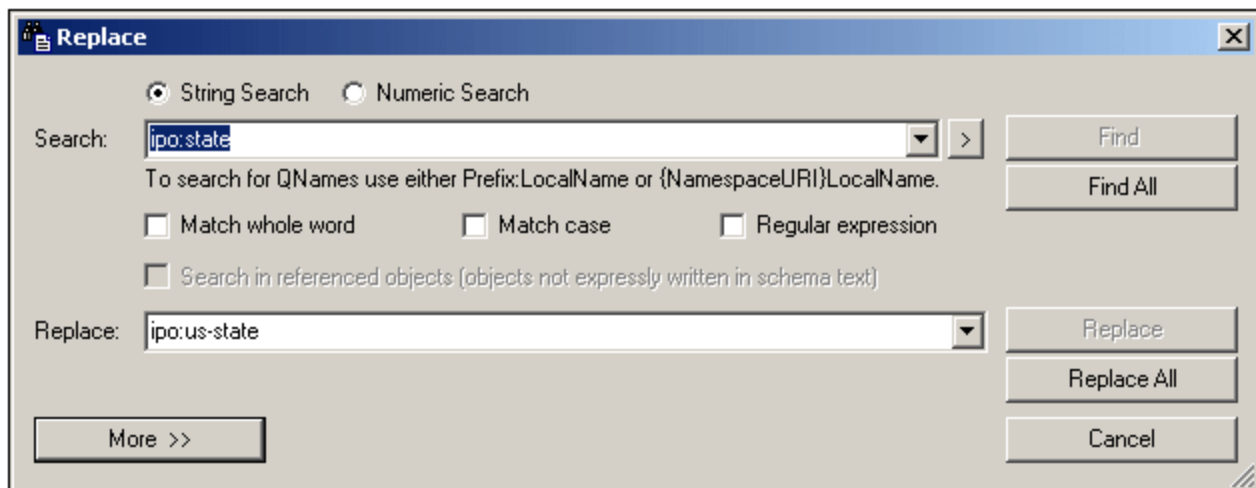

The **Find All** command closes the Replace dialog and lists all the search results in the Find In Schemas window.

The **Replace All** command replaces all occurrences of the found term, closes the Replace dialog, and lists the found terms in the Find In Schemas window.

Note: Regular expressions are not supported in the Replace field.

6.7.6 Results and Information

Each time a **Find**, **Find All**, **Replace**, or **Replace All** command is executed the results of the command execution are displayed in the Find In Schemas window (*screenshot below*). The term that was searched for is displayed in green; (in the screenshot below, it can be seen that `email` was the search term, with no case restriction specified). Notice that the location of the schema file is also given.

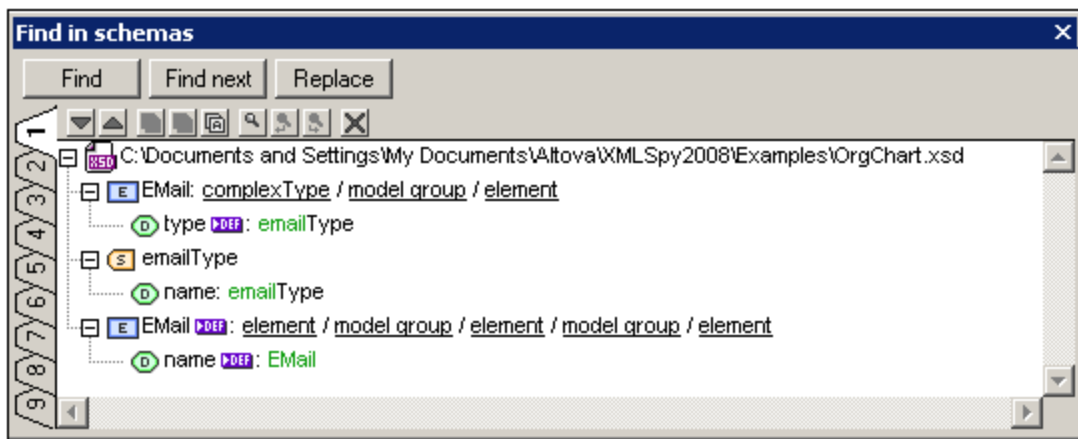

The **Find All** and **Replace All** commands list all the found occurrences in the document.

Note: The **Find** and **Replace** buttons at the top of this window bring up the Find dialog and the Replace dialog, respectively. The **Find Next** button can be used to find the next occurrence of the search term.

Features of the Find In Schemas window

Results are displayed in nine separate tabs (numbered 1 to 9). So you can keep the results of one search in one tab, do a new search, and compare results. Clicking on a result in the Find In Schemas window pops up and highlights the relevant component in the Main Window of Schema View. In this way you can search and navigate quickly to the desired component.

The following Find In Schema toolbar commands are available:

- The **Next** and **Previous** icons select, respectively, the next and previous messages to the currently selected message.
- The **Copy Messages** commands copy, respectively, the selected message, the selected message and its children messages, and all messages, to the clipboard.
- The **Find** commands find text in the Find In Schemas window.
- The **Clear** command deletes all messages in the currently active tab.

6.7.7 Finding and Renaming Globals

Named global components of XML Schemas can be found and renamed in a selected file and in all schema files related to the selected file. Named global components are all global components except: Include, Import, Redefine, Annotation, Comment, and PI components

The process works as follows:

1. In Schema Overview, the global component to be found or renamed is selected.
2. In the context menu that pops up on right-clicking the selected component, select the required command (**Find All References** or **Rename with All References**).

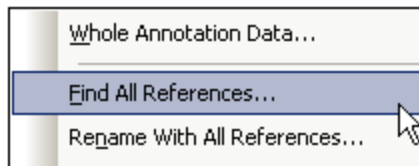

3. In the dialog that pops up, select the scope of the search (or rename operation). In the case of a Rename operation, enter the new name of the global component.
4. On clicking **OK**, the search results are displayed in the Find in Schemas window (*screenshot below*).

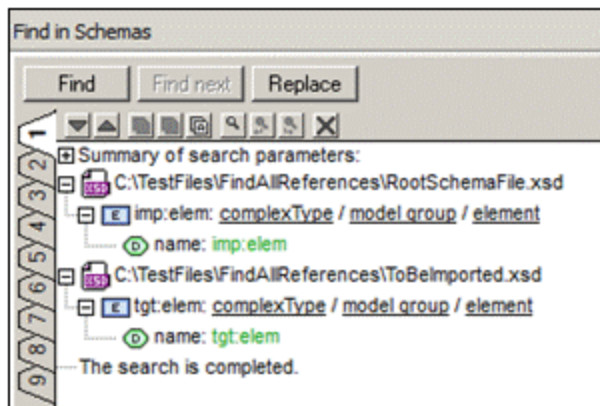

The locations of all files in which references to the global component are found are listed (see *screenshot above*). All renamed components that were found and renamed are also listed.

Find All References

To open the Find All References dialog (*screenshot below*), do the following: (i) Right-click the global component in Schema Overview, (ii) In the context menu that pops up select the **Find All References** command.

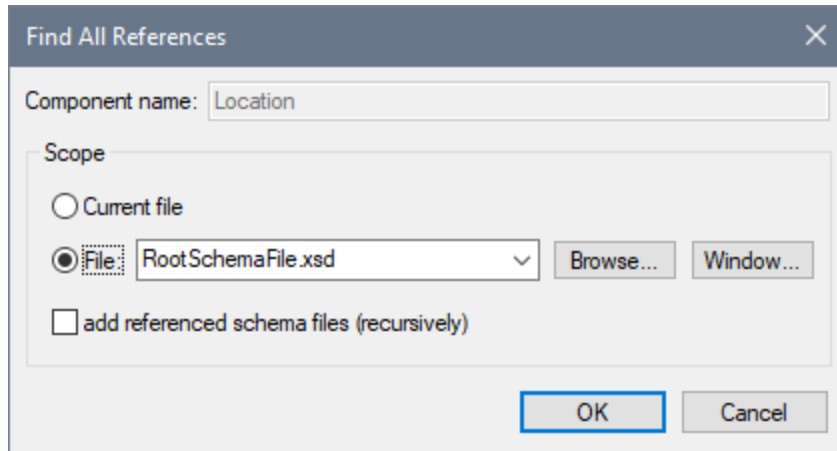

The global component name is displayed in the *Component Name* field, which is grayed out and cannot be edited. You can choose whether the search should be carried out in the current file or in another file you can browse for (or select from a list of open files). You can also then specify whether related files (included, imported, redefined) should be searched, by checking the *Add Referenced Schema Files* check box at the bottom of the dialog.

Rename with All References

To rename a global component, right-click it and select **Rename with All References** from the context menu that pops up. This pops up the Rename with All References dialog (*screenshot below*).

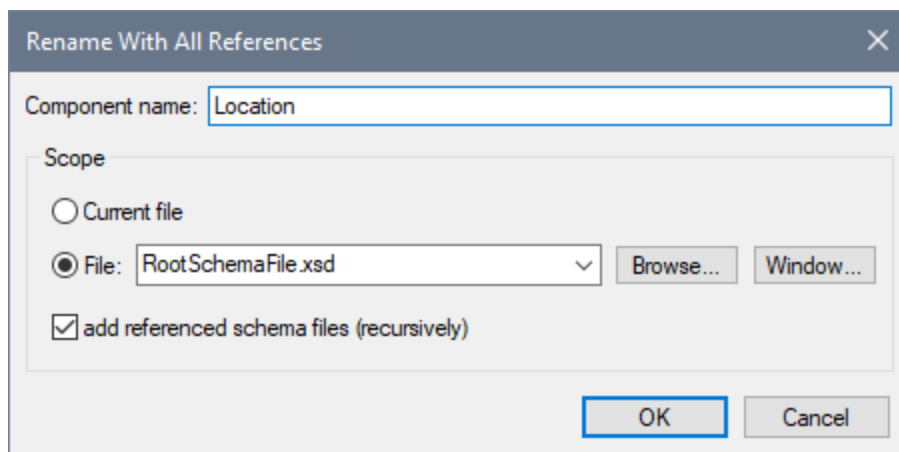

The new name you wish to give the selected global component must be entered in the *Component Name* text field. You can choose whether the search and renaming should be carried out in the current file or in another file you can browse for (or select from a list of open files). You can also then specify whether related files (included, imported, redefined) should be searched, by checking the *Add Referenced Schema Files* check box at the bottom of the dialog.

7 XSLT

Altova website: [🔗 XSLT Editor](#)

This section on XSLT is organized into the following sections:

- [Editing XSLT documents](#)³⁶³: describes the editing support for XSLT documents in XMLSpy
- [XSLT Processing](#)³⁶⁵: shows the various ways in which XSLT transformations can be carried out in the XMLSpy GUI using engines of your choice. This section also explains important XSLT settings in XMLSpy.
- [XSL Outline](#)³⁶⁷: describes the XSL Outline and XSL Info Windows, which together provide a powerful way to view, navigate, and manage a collection of XSLT files.

XPath Evaluation

When an XML document is active, you can use the [XPath/XQuery Window](#)¹¹⁵ to evaluate XPath expressions. This is a very useful feature to quickly check how an XPath expression will be evaluated. Type in an XPath expression and specify whether it should be evaluated relative to the document root or to a selected context node in the XML document. The result of the evaluation will be displayed immediately in the XPath/XQuery Window. How to use the XPath/XQuery Window is described in the section [GUI and Environment | XPath/XQuery Window](#)¹¹⁵.

XSLT Debugger

XMLSpy also contains an [XSLT Debugger](#)³⁹⁹ to help you create correct and efficient XSLT stylesheets faster. These two features are described in the section [XSLT and XQuery Debugger](#)³⁹⁹.

Additional XSLT features

Additional and more detailed information about the various features described in this section is in the descriptions of the [relevant menu commands](#)⁹⁰⁶ (in the User Reference section).

Altova XSLT Engines

For details about how the Altova XSLT 1.0, 2.0, and 3.0 Engines are implemented, see [XSLT and XQuery Engine Information](#)¹⁵⁴⁴ in the [Appendices](#)¹⁵⁴³.

RaptorXML for command line and batch processing

The XMLSpy GUI enables batch processing via the projects functionality. However, if you are looking for more flexibility, you should try [Altova's RaptorXML product](#), which provides fast XML validation, XSLT transformation, and XQuery execution functionality. RaptorXML is ideal if you wish to perform XSLT transformations from the command line, or batch processing.

7.1 XSLT Documents

XSLT 1.0, 2.0, and 3.0 documents can be edited in [Text View](#)¹³⁰ and [Grid View](#)¹⁴⁶, and are edited like any other XML document in [Text View](#)²⁸⁷ and [Grid View](#)¹⁴⁶. The default view in which an XSLT document is opened can be set in the File Types section of the Options dialog.

Entry helpers

Entry helpers are available for elements, attributes, and entities. Information about the items displayed in the entry helpers is built into XMLSpy, and is not dependent on references contained in the XSLT document.

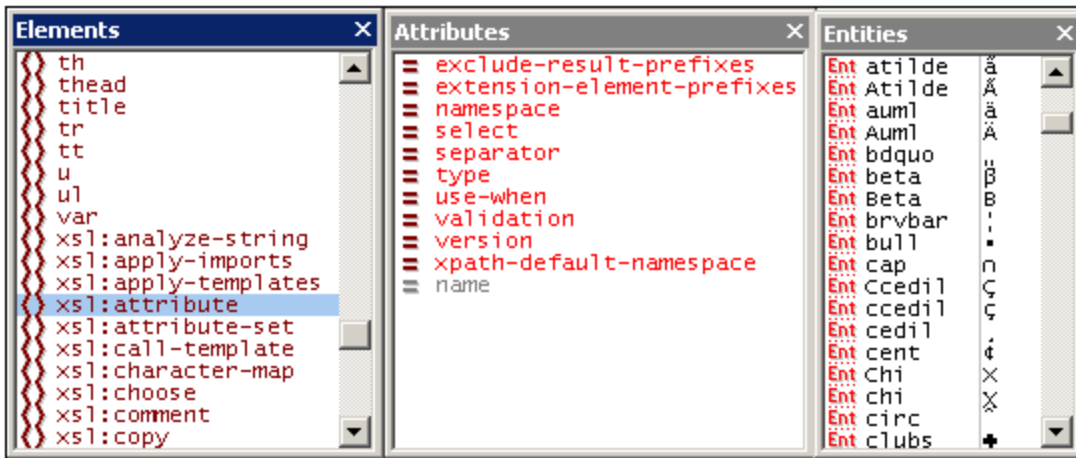

The following points should be noted:

1. If a new XSLT document is created via the Create a New Document dialog (**File | New**), then the appropriate XSLT elements and attributes (XSLT 1.0, XSLT 2.0, or XSLT 3.0, depending upon which document type was created) are loaded into the entry helpers. Additionally, HTML elements and attributes are loaded, as well as the HTML 4.0 entity sets, [Latin-1](#), [special characters](#), and [symbols](#).
2. If an XML document is created via the Create a New Document dialog (**File | New**) and given XSLT content, no entry helper items are available except for XML character entities.
3. If an XSLT document is opened that was created as an XSLT document via the Create a New Document dialog (**File | New**), then the entity helpers will be as in Point 1 above.
4. If an XSLT document is opened that was **not** created as an XSLT document via the Create a New Document dialog (**File | New**), then the entity helpers will be as in Point 1 above. Additionally, XSL-FO elements and attributes will be listed in the Text View entry helpers.
5. The prefixes of elements in the Elements entry helper are as follows and are invariable: `xsl:` prefix for XSLT elements; no prefix for HTML elements; `fo:` prefix for XSL-FO elements. Consequently, in order to use the entry helpers, the namespace declarations in the XSLT document must define prefixes that match the built-in prefixes shown in the entry helpers.

Auto-completion

In Text View, auto-completion is available in a pop-up as you type. The first item in the pop-up list that matches the typed text is highlighted. When an **element** is being typed, a list of elements pops up with the first nearest match in alphabetical order being highlighted. Similarly, when an **attribute** is being typed in, a list of applicable attributes pops up. The items in the list are determined according to the rules described in the previous section about entry helpers.

XPath intelligent editing

At locations in the XSLT document where XPath expressions can be entered (for example, inside the value of a `select` attribute, inside attribute value templates, and XSLT 3.0 value templates), the following features are available.

- Syntax coloring for the XPath constructs, including matching brackets during typing.
- A hover tip if the cursor is placed over an XPath function. The tip contains information about the function.
- XPath functions and axes are suggested in popups as you type. You can move up or down the list of suggestions with the **Up/Down** cursors. If the item that is highlighted in the popup is a function, then information about the function (its signature) is displayed in an additional popup.
- If an XML file has been assigned in the [Info window](#)³⁷¹, then the elements and attributes of the XML file will also be available in the popup.

Validating XSLT documents

The XSLT document can be validated against the XSLT schema built into XMLSpy (click **XML | Validate (F8)**). The correct built-in schema is automatically selected according to whether the XSLT document is XSLT 1.0, XSLT 2.0, or XSLT 3.0 (specified in the `version` attribute of the `xsl:stylesheet` element).

7.2 XSLT Processing

In the XMLSpy GUI, two types of XSLT transformation are available:

- The **XSL/XQuery | XSL Transformation (F10)** command is used for straightforward XML transformations with an XSLT stylesheet to result formats specified and described in the stylesheets.
- The **XSL/XQuery | XSL-FO Transformation** command is used: (i) for transformations of XML to FO to PDF in two steps, and (ii) for one-step transformations of FO to PDF.

Specifying the XSLT processor for the transformation

The XSLT engine that will be used for transformations is specified in the [XSL section of the Options dialog](#)¹⁰⁶⁸ (screenshot below).

Built-in RaptorXML XSLT engine (Important: the built-in engine is always used for XSLT debugging)

Validate XML files used in transformation

Microsoft® XML Parser (MSXML): v3.0 v4.0 v6.0 Choose version automatically

External XSL transformation program:

Please enter the command line for executing an external XSL transformation program in the form:
Program.exe %1 %2 %3

where %1 will be replaced with the XML input file name, %2 with the output file name and %3 (optional) with XSL style-sheet file name. Feel free to add any other parameters that are required by the external program.

Show external program output in Messages window after transformation

Show external program error output in Messages window after transformation

Default file extension of output file: Reuse output window

Use file extension from <xml:output method=""> attribute if provided

Please enter path to XSL-FO transformation engine (if using FOP enter path to fop.bat):

Use XSLT engine selected above to perform XSLT part and then XSL-FO engine for FO part

Use XSL-FO engine for both XSLT and FO parts of transformation

The available options are explained in the [User Reference](#)¹⁰⁶⁸ section. The engine specified in the XSL section will be used for all XSLT transformations. Note that for the XSL-FO transformation, an additional XSLT engine option is available: the XSLT engine that is packaged with some FO processors. To select this option, select the corresponding radio button at the bottom of the XSL section (see screenshot above).

Specifying the FO processor

The FO processor that will be used for transformations of FO to PDF is specified in the text box at the bottom of the [XSL section of the Options dialog](#)¹⁰⁶⁸ (screenshot above).

XSLT 1.0, 2.0, 3.0 and Altova's XSLT engines

The XSLT version of a stylesheet is specified in the `version` attribute of the `xsl:stylesheet` (or `xsl:transform`) element. XMLSpy contains the built-in Altova XSLT 1.0, Altova XSLT 2.0, and Altova XSLT 3.0 engines, and the appropriate engine is selected according to the value of the `version` attribute (1.0 or 2.0 or 3.0).

XSLT Transformation

The **XSLT Transformation (F8)** command can be used in the following scenarios:

- To transform an XML document that is active in the GUI and has an XSLT document [assigned](#)⁹¹³ to it. If no XSLT document is assigned, you are prompted to make an assignment when you click the **XSLT Transformation (F8)** command.
- To transform an XSLT document that is active in the GUI. On clicking the **XSLT Transformation (F8)** command, you are prompted for the XML file you wish to process with the active XSLT stylesheet.
- To transform project folders and files. Right-click the project folder or file and select the command.

XSL:FO Transformation

The **XSL:FO Transformation** command can be used in the following scenarios:

- To transform an XML document that is active in the GUI and has an XSLT document [assigned](#)⁹¹³ to it. The XML document will first be transformed to FO using the specified XSLT engine. The FO document will then be processed with the specified FO processor to produce the PDF output. If no XSLT document is assigned, you are prompted to make an assignment when you click the **XSL:FO Transformation** command.
- To transform an FO document to PDF using the specified FO processor.
- To transform an XSLT document that is active in the GUI. On clicking the **XSL:FO Transformation** command, you are prompted for the XML file you wish to process with the active XSLT stylesheet.
- To transform project folders and files. Right-click the project folder or file and select the command.

For a description of the options in the [XSL:FO output dialog](#)⁹⁰⁸, see the [User Reference section](#)⁹⁰⁸.

Parameters for XSLT

If you are using the Altova XSLT engines, XSLT parameters can be stored in a convenient GUI dialog. All the stored parameters are passed to the XSLT document each time you transform. For more information, see the description of the [XSLT Parameters / XQuery Variables](#)⁹¹⁰ command.

Batch processing with RaptorXML

RaptorXML is a standalone application that contains Altova's newest XML validator, XSLT engines, and XQuery engines. It can be used from the command line, via a COM interface, in Java programs, and in .NET applications to validate XML documents, transform XML documents using XSLT stylesheets, and execute XQuery documents.

XSLT transformation tasks can therefore be automated with the use of RaptorXML. For example, you can create a batch file that calls RaptorXML to transform a set of documents. See the [RaptorXML documentation](#) for details.

7.3 XSL Outline

When an XSLT document is the active document in XMLSpy, information about the structure of the document is displayed in the [XSL Outline window](#)³⁶⁸ and information about the files related to the active XSLT document is displayed in the [XSLT tab of the Info Window](#)³⁷¹ (which is displayed only when an XSLT document is the active document in XMLSpy). Additionally, via these two windows, a number of commands are available that facilitate editing the XSLT document and managing files related to it.

In the [XSL Outline window](#)³⁶⁸ (screenshot below), you can do the following:

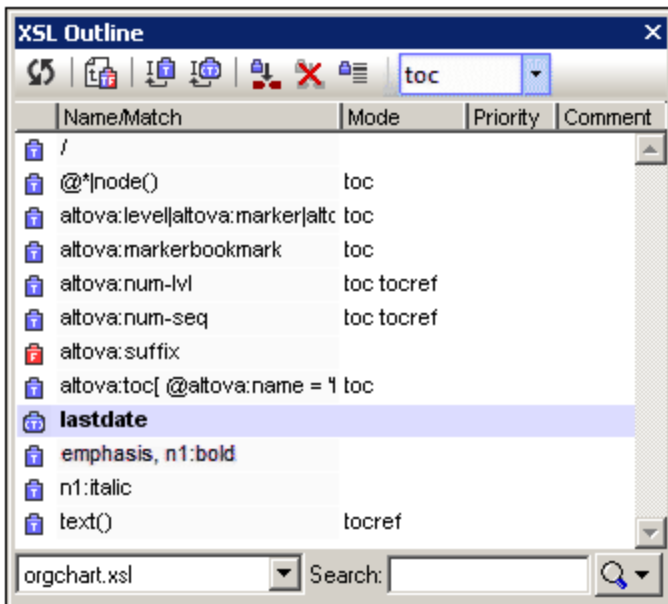

- View the templates and functions in the active XSLT document and in all imported and included XSLT documents.
- Sort the templates and functions on the basis of their names or match expressions, mode, priority, or comments.
- Search for specific templates on the basis of their names/expressions.
- Use the XSL Outline to navigate to the corresponding template in the XSLT document.
- Quickly insert calls to named templates.
- Set a selected named template as the entry point for transformations.

See the section [XSL Outline window](#)³⁶⁸ for details.

In the [XSLT tab of the Info Window](#)³⁷¹ (screenshot below), you can do the following:

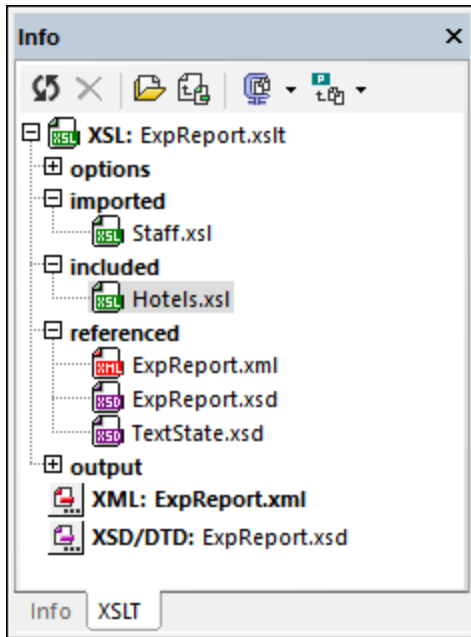

- View information about all the files related to the active XSLT document, such as the locations of imported and included files.
- Set an XML file for transformation with the active XSLT document. Also, the schema (XSD/DTD) file can be set for validating the selected XML file.
- Open a related file from within the Info Window.
- Quickly organize all related files into XMLSpy projects.
- Zip all related files to a user-defined location.

The [XSL Outline window](#)³⁶⁸ and the [XSLT tab of the Info Window](#)³⁷¹ are described in detail in the sub-sections of this section.

7.3.1 XSL Outline Window

In the XSL Outline Window (*screenshot below*), all templates and functions in the active XSLT document are listed. Templates are indicated with blue icons (templates without a parameter; and templates containing parameters). Functions are indicated with a red icon. In the combo box in the bottom left-hand of the window, you can select whether the templates and functions listed are from: (i) only the active XSLT document (as in the screenshot below), or (ii) the active XSLT document and all included and imported stylesheets.

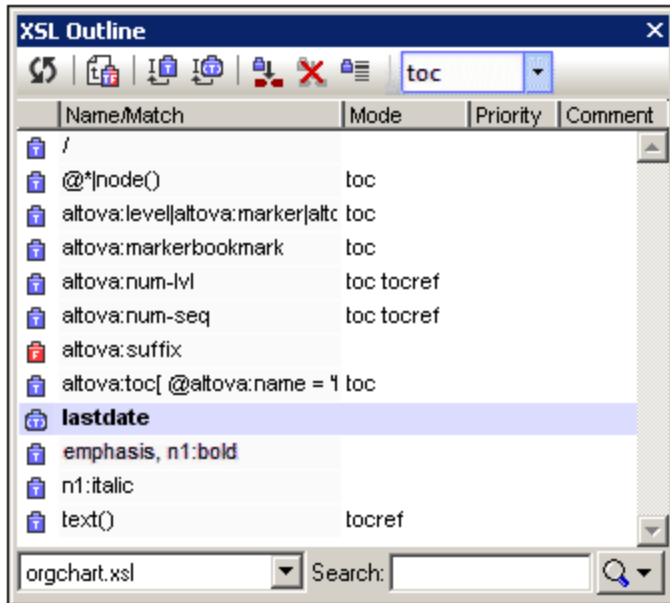

There are two types of templates: (i) named templates, and (ii) templates that match an XPath expression. Each template is listed with:

- Its name (if the template has a `name` attribute) and/or XPath expression (if the template has a `match` attribute). If the template has both, a `name` and a `match` attribute, then both are listed, with the value of the `name` attribute first: `namevalue, matchvalue` (see the template named **bold** in the screenshot above).
- Its mode, if any. Note that a template may have more than one mode (see screenshot above).
- Its priority, if any;
- The comment that directly precedes the template or function, if any.



Functions in the stylesheet are listed by their names. Functions have neither mode nor priority.

Operations

The following operations can be performed in the XSL Outline Window:

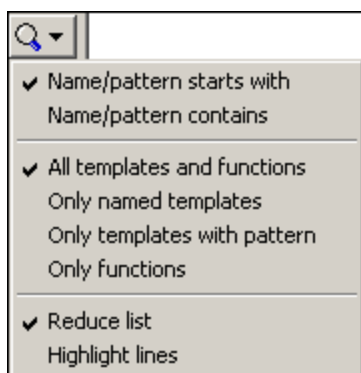
- *Filtering*: The list displayed in the window can be filtered to show one of the following: (i) all templates and functions (the default setting each time XMLSpy is started); (ii) named templates only; (iii) XPath-expression templates only; (iv) functions only. To select the required filter, click the dropdown arrow to the right of the Search box at bottom right of the window (screenshot below), and select the required filter (the second group of commands in the menu). The selected filter is applied immediately and applies from this moment onwards till it is modified or till XMLSpy is closed.



- **Sorting and locating:** Each column can be sorted alphabetically by clicking the column header. Each subsequent click reverses the previous sorting order. After a column has been sorted in this way, if you select any item in the list and then quickly type in a term from the sorted column, the first item in the list that contains that term will be highlighted. In this way, you can quickly go to templates of a particular name/expression, mode, or priority.
- **Searching:** Enter in the Search box (at bottom right) the name or XPath expression for which you wish to search. The search results are displayed as you type. The following search options are available in the dropdown list of the Search box (*screenshot above*): (i) whether the name or expression either starts with or contains the search term (the first group of commands in the menu); the starts-with option is the default each time XMLSpy is started; (ii) whether the search results should be displayed as a reduced list or be highlighted (the third group of commands in the menu); the reduced-list option is the default each time XMLSpy is opened. These selections are applied immediately and remain in effect till changed or till XMLSpy is closed.
- **Reloading:** After the stylesheet has been modified, click the **Synchronize** icon  in the window's toolbar to update the XSL outline.
- **Go to item:** When a template or function is selected in the XSL Outline window, clicking the **Go to Definition** icon  in the window's toolbar highlights the template or function in the document in Design View. Alternatively, double-click an entry to go to it.
- **Named template actions:** Two groups of actions can be carried out involving named templates: (i) Calls to the named template (with `xsl:call-template`) can be inserted in the stylesheet at the cursor insertion point; and (ii) A named template can be set as the entry point for a transformation. The commands for these actions are carried out via icons in the toolbar and are described below.

Template mode for transformation

The combo box in the toolbar, called *Set mode for transformation*, lists (i) all the modes in the stylesheet, plus (ii) an empty entry (which selects the default mode) and, in the case of XSLT 3.0 stylesheets, (iii) the `#unnamed` mode. Selecting a mode from the dropdown list, sets the selected mode as the mode for the transformation. The `#unnamed` mode (for all XSLT versions) applies to all templates that have no `mode` attribute.

In the case of XSLT 1.0 and XSLT2.0 stylesheets, the default mode is the `#unnamed` mode. So selecting the empty entry selects the default mode (which is the `#unnamed` mode and which therefore applies to all templates with no `mode` attribute).

In XSLT 3.0 stylesheets, the top-level `xslt` element can have a `default-mode` attribute, which holds the default mode for the transformation. If, in the *Set mode for transformation* combo box, the empty entry (default mode) is selected, then the mode specified in the `default-mode` attribute will be used as the transformation mode. If `#unnamed` mode is selected in the combo box, then the transformation will be applied to all templates with an unnamed mode, that is, to templates with no `mode` attribute.

Note: A template can be given a mode value of `#all` to make it applicable to all modes.

Named templates

When a named template is selected, one or more commands in the window's toolbar relating to named templates become enabled (*screenshot below*).



The commands in the toolbar (*screenshot above*) are, from left to right:

- *Insert xsl:call-template:* This command becomes active when a named template is selected in the XSL Outline window. The command inserts an `xsl:call-template` element at the cursor insertion point in the stylesheet. The `name` attribute of the `xsl:call-template` element that is inserted in the stylesheet is given a value that is the value of the `name` attribute of the selected named template. This makes the `xsl:call-template` a call to the selected named template.
- *Insert xsl:call-template with param:* This command becomes active when a named template having one or more `xsl:param` child elements is selected in the XSL Outline window. As with the **Insert xsl:call-template** command, the command inserts an `xsl:call-template` element, but in this case with a corresponding `xsl:with-param` child element for every `xsl:param` child element of the selected named template. The names of the inserted `xsl:call-template` and its `xsl:with-param` child elements correspond to the names of the selected named template and its `xsl:param` children.
- *Set the selected named template as entry point for transformation:* When a named template is set as the entry point for a transformation, transformations executed in XMLSpy start at this named template. In the XSL Outline Window, such a named template is indicated in boldface (see screenshot at the start of this section).
- *Clear named template as entry point for transformation:* Becomes active once a named template has been set as the entry point for transformations.
- *Jump to the named template selected as the entry point for transformations:* Becomes active once a named template has been set as the entry point for transformations. When the focus in the XSL Outline window is at some other point than the named template set as the entry point for transformations, clicking this icon highlights the named template in the XSL Outline window, thus making access to it faster.

7.3.2 Info Window

The XSLT tab of the Info Window is displayed only when an XSLT document is the active document in XMLSpy. It displays all the imported and included XSLT files related to the active XSLT document. You can also select an XML file to transform with the XSLT when transformation is started with the XSLT being the active document.

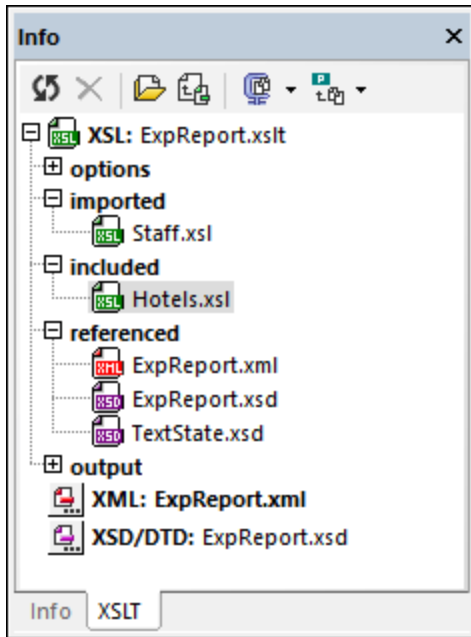

The following files are displayed in the XSLT tab of the Info Window:

- *XSLT files*: All imported and included XSLT files are listed (see screenshot above). The location of each file is displayed in a pop-up when the mouse cursor is placed over the file. Double-clicking an imported or included file, or selecting it and then clicking the **Open** icon in the Info Window toolbar, opens the file in a new window. The **Go to Include/Import Location** icon in the toolbar highlights the include/import declaration in the active XSLT document.
- *XML file*: An XML file can be assigned to the active XSLT stylesheet for transformations. The location of the assigned XML file is displayed in a pop-up when the mouse cursor is placed over the file. If an XML file is specified and the menu command **XSL/XQuery | XSL Transformation (F10)** is clicked, a transformation is executed on the defined XML file using the active XSLT document as the stylesheet. The XML file can be selected by clicking the **XML** icon and browsing; the selected file is displayed in bold face. Alternatively, the XML file can be assigned via the Project Properties dialog (*Input XML for XSL/XQuery/Update transformation*) or via a processing instruction in the XSLT document: `<? altova_samplexml "Products.xml"?>`. In each case, the XML file will be shown in the Info Window with the relevant icon:

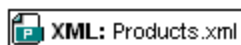

assigned via the Project Properties dialog

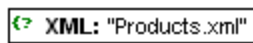

assigned via a processing instruction in the XSLT document

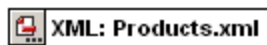

assigned by clicking the XML icon and browsing for the required file; entry is in bold font face

In the event that more than one of the above assignments exists, the selection priority is: (i) project; (ii) processing instruction; (iii) browsed by user. The XML file can be opened by double-clicking it or by selecting it and clicking the **Open** toolbar icon.

- *XSD/DTD file*: If the selected XML file has a reference to a schema (XML Schema or DTD), then this schema file is displayed in the XSD/DTD entry. Alternatively, just as with the XML file, the schema file can be selected via the Project Properties dialog (*Validation*) or by clicking the **XSD/DTD** icon and browsing for the required schema file. If the schema file is selected via the Projects Properties dialog, a Projects icon is displayed next to the entry, otherwise the clickable **XSD/DTD** icon is displayed with the file entry either in a normal font face (when the schema is referenced from the XML file) or bold font face (schema browsed for by the user via the **XSD/DTD** icon). Should the schema file be assigned via more than one method, then the order of priority is as follows: (i) project; (ii) browsed by user; (iii) reference in XML document. The location of the assigned XSD file is displayed in a pop-up when the mouse cursor is placed over the file. The schema file can be opened by double-clicking it or by selecting it and clicking the **Open** toolbar icon.

Note: If an XML or XSD/DTD file is selected via the Project Properties dialog, then to clear this selection, you must go to the Project Properties dialog and clear the setting there. If the selection has been made by browsing via the **XML** or **XSD/DTD** icons, then to clear this setting, select the file and click the **Clear** icon in the Info Window toolbar.

Options

XPath intelligent editing: If an XML file has been assigned, the structure of the XML document is known and [intelligent XPath editing](#)³⁶³ will extend to elements and attributes. At locations in the XSLT document where an XPath expression can be entered, available elements and attributes will be shown in a popup. This option is switched on by default. To disable XPath intelligent editing, uncheck the check box. The setting is saved for each XSLT file separately when the file is closed, and will be used each time the file is opened.

Toolbar icons

The Info Window toolbar icons (*screenshot below*) are, from left to right:

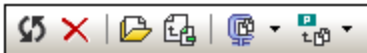

- *Reload info*: Updates the Info Window to reflect modifications made in the XSLT document.
- *Clear XML/XSD assignment*: Clears an XML or XSD/DTD assignment made by the user by browsing via the XML or XSD/DTD icons, respectively. Select the file to clear and then click this icon.
- *Open document*: Opens the selected document.
- *Go to import/include location*: When an imported or included file is selected, clicking this icon highlights the relevant import or include declaration in the XSLT document.
- *Zip all local documents*: Zips all the documents listed in the Info Window to a user-defined location. Alternatively, only the selected documents can be zipped; do this by selecting, in the dropdown menu of this icon, the command **Zip selected local documents**.
- *Add all files to projects*: Adds all files to the current projects. Alternatively, only the selected documents can be added; do this by selecting, in the dropdown menu of this icon, the command **Add selected files to project**.

8 XQuery

Altova website: [XQuery Editor](#)

XQuery and [XQuery Update](#)³⁸⁷ documents can be edited in Text View. This view (see *screenshot*) provides entry helpers, syntax coloring, and intelligent editing to make editing easy. In addition, you can validate your XQuery document and run it (with an optional XML file if required) using the built-in Altova XQuery Engine.

```

7  (: Section: 1.6.4.2 Q2 Find news items where the Foobar Corporation
8  and one or more of its partners are mentioned in the same paragraph
9  and/or title. List each news item by its title and date. :)
10 declare function local:partners($company as xs:string) as element()*
11 {
12   let $c := doc("company-data.xml")//company[name = $company]
13   return $c//partner
14 };
15 <items>
16 {
17   let $foobar_partners := local:partners("Foobar Corporation")
18   for $item in doc("string.xml")//news_item
19   where
20     some $t in $item//title satisfies
21       (contains($t/text(), "Foobar Corporation")
22        and (some $partner in $foobar_partners satisfies
23             contains($t/text(), $partner/text())))
24     or (some $par in $item//par satisfies
25         (contains(string($par), "Foobar Corporation")
26          and (some $partner in $foobar_partners satisfies
27               contains(string($par), $partner/text()))))
28   return
29     <news_item>
30       { $item/title }
31       { $item/date }
32     </news_item>
33 }</items>
34

```

Note: XQuery and XQuery Update files can be edited only in Text View. No other views of XQuery files are available.

XQuery and XQuery Update file associations

In XMLSpy, XQuery and XQuery Update documents are recognized as two different document types. Typically XQuery documents have the **.xq** extension, while XQuery Update documents have the **.xqu** file extension. You can associate additional file extensions with these filetypes, and also change filetype associations, at any time, in the *File Type* section of the Options dialog ([Tools | Options | FileType](#)¹⁰⁴³).

The document type association of a file extension is important because, depending on the this association, either an XQuery execution or an [XQuery Update](#)³⁸⁷ will be carried out when the **XQuery/ Update Execution** command is run.

In this section

This section is organized as follows:

- [Editing XQuery Documents](#) ³⁷⁶
- [XQuery Evaluation](#) ³⁸³
- [XQuery Validation](#) ³⁸⁴
- [XQuery Execution/Update](#) ³⁸⁵
- [XQuery Update Facility](#) ³⁸⁷
- [XQuery and XML Databases](#) ³⁹⁴

Other related features and information:

- [XSLT/XQuery Debugger and Profiler](#) ³⁹⁸
- [XQuery Engine Implementation](#) ¹⁵⁴⁴
- [Output Window: XPath/XQuery](#) ¹¹⁵
- [Tools | Options | File Types](#) ¹⁰⁴³
- [Tools | Options | XQuery](#) ¹⁰⁷¹

RaptorXML for command line and batch processing

The XMLSpy GUI enables batch processing via the projects functionality. However, if you are looking for more flexibility, you should try [Altova's RaptorXML product](#), which contains Altova's newest XQuery Engine.

RaptorXML is ideal if you wish to perform XQuery executions from the command line, or batch processing.

8.1 Editing XQuery Documents

In XMLSpy, XQuery and XQuery Update documents are recognized as two different document types. The document type (XQuery or XQuery Update) is assigned to a file extension in the *File Types* section of the Options dialog ([Tools | Options | FileType](#)¹⁰⁴³, *screenshot below*). When a file of XQuery or XQuery Update type is opened in XMLSpy, the XQuery editing features of Text View are available for that file.

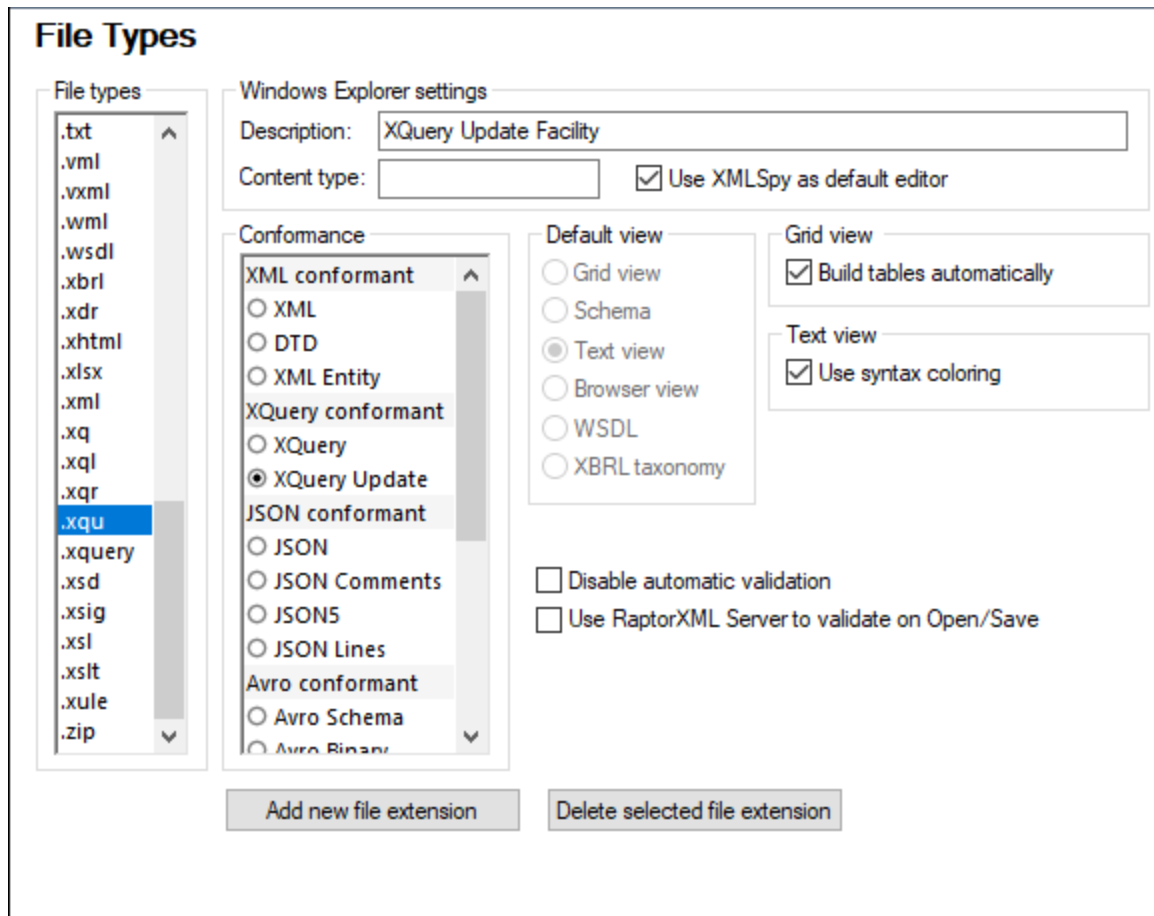

File extensions currently defined as XQuery and XQuery Update in XMLSpy

XQuery	.xq	.xql	.xqr	.xquery
XQuery Update	.xqu			

Note: The editing features described in this section are identical for XQuery and XQuery Update documents.

XQuery Execution/Update

The GUI command **XSL/XQuery | XQuery/ Update Execution** automatically runs either an XQuery execution or XQuery update depending on the filetype of the XQuery file that is selected to be run. See the section [XQuery Execution/Update](#)³⁸⁵ for more details.

8.1.1 XQuery Documents

An XQuery or XQuery Update document is opened automatically in XQuery editing mode of Text View if it is XQuery or XQuery Update conformant. A file is defined as conforming to a certain document type in the *File Types* section of the Options dialog ([Tools | Options | FileType](#)¹⁰⁴³, *screenshot below*).

File extensions currently defined as XQuery and XQuery Update in XMLSpy

XQuery	.xq	.xql	.xqr	.xquery
XQuery Update	.xqu			

Setting additional file extensions to be XQuery conformant

To set additional file extensions to be XQuery conformant:

1. Select **Tools | Options**. The Options dialog appears (*screenshot below*).

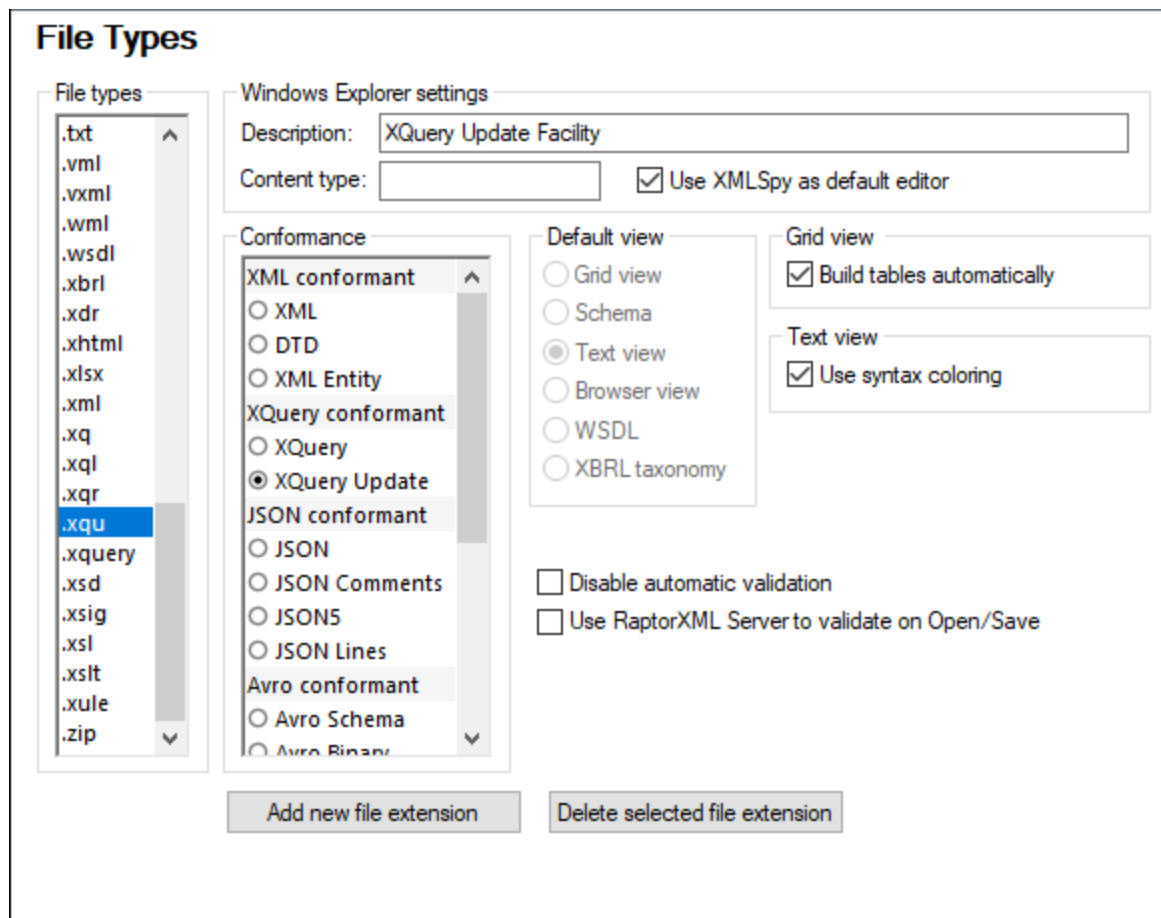

2. Select the **File Types** section.
3. Click **Add new file extension** to add the new file extension to the list of file types.
4. Under *Conformance*, select *XQuery conformant.*, and then *XQuery* or *XQuery Update*.

You should also make the following settings:

- *Description:* XML Query Language or XQuery Update Facility
- *Content type:* text/xml
- If you wish to use XMLSpy as the default editor for XQuery files, activate the *Use XMLSpy as default editor* check box.

8.1.2 XQuery Entry Helpers

There are three Entry Helpers in XQuery mode of Text View: XQuery Keywords (blue), XQuery Variables (purple), and XQuery Functions (olive).

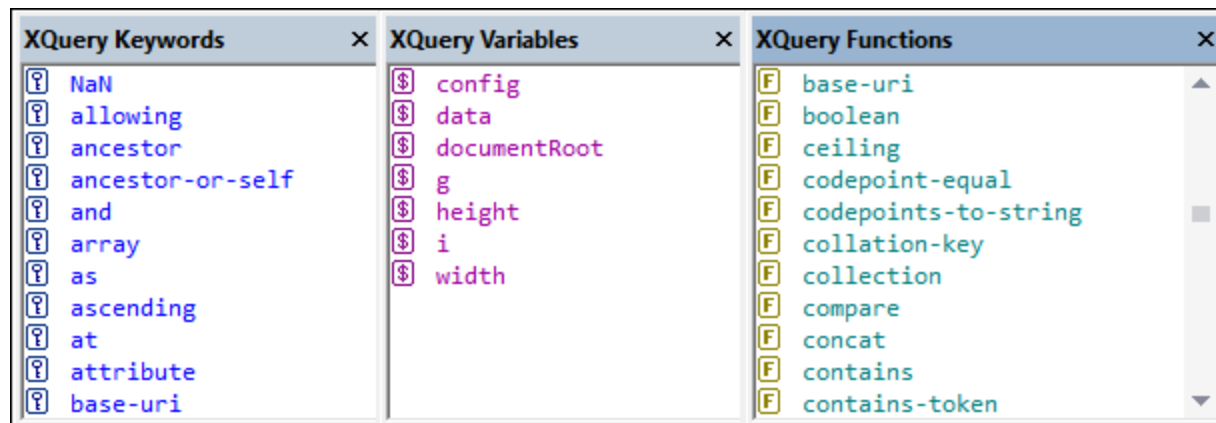

Note the following points:

- The color of items in the three Entry Helpers are different and correspond to the syntax coloring used in the text. These colors cannot be changed.
- The listed keywords and functions are those supported by the Altova XQuery Engines.
- The variables are defined in the XQuery document itself. When a \$ and a character are entered in Text View, the character is entered in the Variables Entry Helper (unless a variable consisting of exactly that character exists). As soon as a variable name that is being entered matches a variable name that already exists, the newly entered variable name disappears from the Entry Helper.
- To navigate in any Entry Helper, click an item in the Entry Helper, and then use either the scrollbar, mouse wheel, or page-down and page-up to move up and down the list.

To insert any of the items listed in the Entry Helpers into the document, place the cursor at the required insertion point and double-click the item. Note that some character strings represent both a keyword and a function (`empty`, `unordered`, and `except`). The appropriate item is inserted depending on what you double-click.

8.1.3 XQuery Syntax Coloring

An XQuery document can consist of XQuery code as well as XML code. The default syntax coloring for the XQuery code is described in this section. The syntax coloring for XML code in an XQuery document is the

same as that used for regular XML documents. All syntax coloring (for both XQuery code and XML code) is set in the [Fonts and Colors section](#)¹⁰⁶⁰ of the Options dialog (**Tools | Options**). Note that XQuery code can be contained in XML elements by enclosing the XQuery code in curly braces { } (see *screenshot for example*).

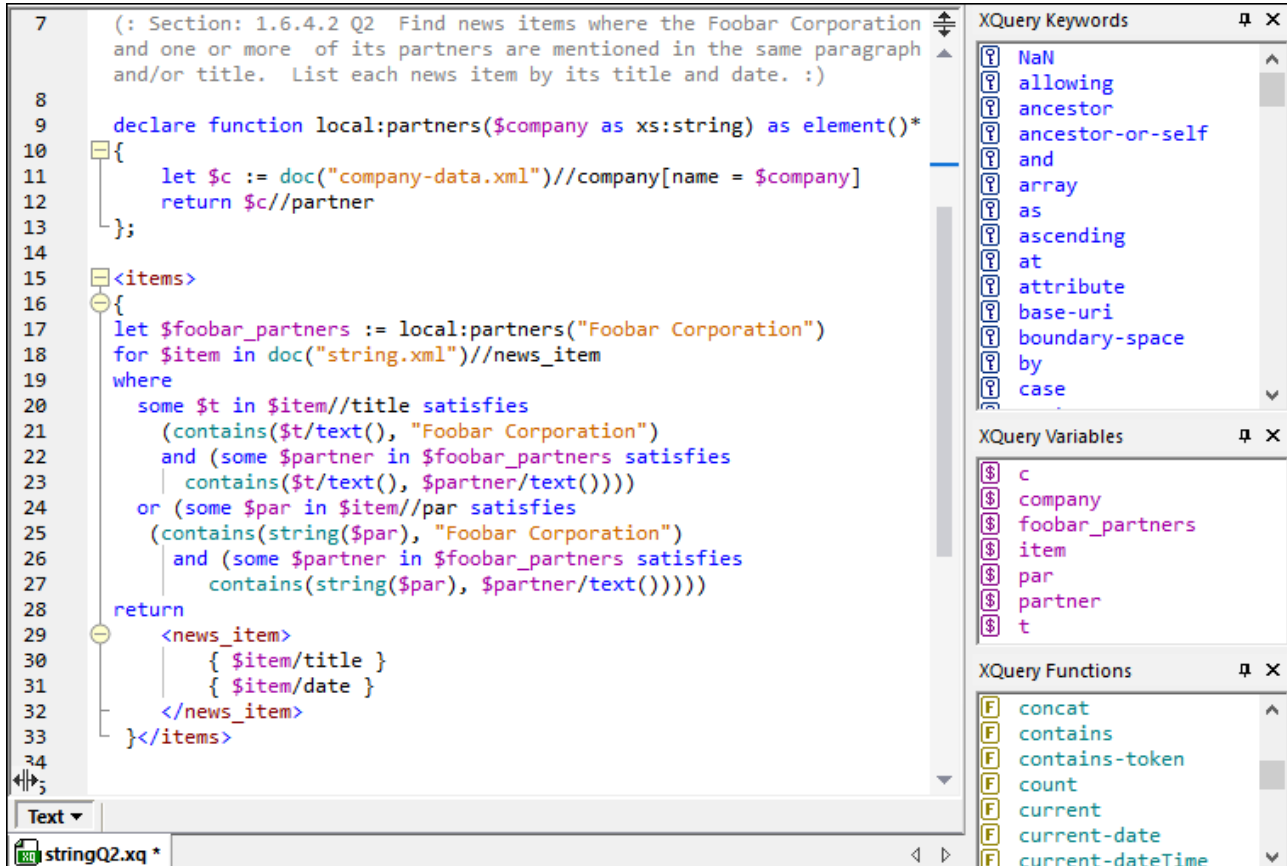

In XQuery code in the XQuery Mode of Text View, the following default syntax coloring is used:

- *(: Comments, including 'smiley' delimiters, are in gray :)*
- XQuery Keywords are in blue: **keyword**
- XQuery Variables, including the dollar sign, are in purple: **\$start**
- XQuery Functions, but **not** their parentheses, are in green: **function()**
- Strings are in orange: **"Procedure"**
- All other text, such as path expressions, is black (*shown underlined below*). So:

```

for $s in doc("report1.xml")//section[section.title = "Procedure"]
return ($s//incision)[2]/instrument)

```

You can change these default colors and other font properties in the [Fonts and Colors section](#)¹⁰⁶⁰ of the Options dialog (**Tools | Options**).

8.1.4 XQuery Intelligent Editing

The XQuery mode of Text View provides the following intelligent editing features.

- [Bracket-matching](#) ³⁸⁰
- [Keywords](#) ³⁸⁰
- [Variables](#) ³⁸¹
- [Functions](#) ³⁸¹
- [Visual guides](#) ³⁸¹

Bracket-matching

The bracket-matching feature highlights the opening and closing brackets of a pair of brackets, enabling you to clearly see the contents of a pair of brackets. This is particularly useful when brackets are nested, as in XQuery comments (see *screenshot below*).

```
1  ☐ (: (: (Filename: seqQ5b.xq :))
2  | (: (Source: http://www.w3.org/TR/xquery-use-cases :):)|
```

- Bracket-matching is activated when the cursor is placed either immediately before or immediately after a bracket (either opening or closing). That bracket is highlighted (bold black) together with its corresponding bracket. Notice the cursor position in the screenshot above.
- Bracket-matching is enabled for round parentheses (), square brackets [], and curly braces { }. The exception is angular brackets <>, which are used for XML tags.

Note: When you place the cursor just inside a start or end bracket, both brackets are highlighted. Pressing **Ctrl+E** moves the cursor to the other member of the pair. Pressing **Ctrl+E** repeatedly enables you to switch between the start and end brackets. This is another aid to quickly navigating your document.

Keywords

XQuery keywords are instructions used in query expressions, and they are displayed in blue. You select a keyword by placing the cursor inside a keyword, or immediately before or after it. With a keyword selected, pressing **Ctrl+Space** causes a complete list of keywords to be displayed in a pop-up menu. You can scroll through the list and double-click a keyword you wish to have replace the selected keyword.

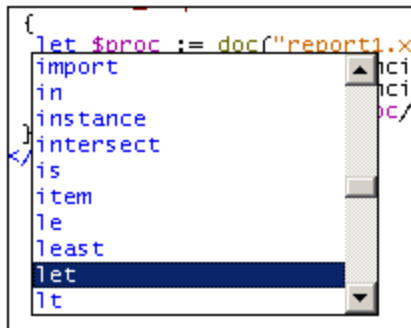

In the screenshot above, the cursor was placed in the `let` keyword. Double-clicking a keyword from the list causes it to replace the `let` keyword.

Variables

Names of variables are prefixed with the \$ sign, and they are displayed in purple. This mechanism of the intelligent editing feature is similar to that for keywords. There are two ways to access the pop-up list of all variables in a document:

- After typing a \$ character, press **Ctrl+Space**
- Select a variable and press **Ctrl+Space**. (A variable is selected when you place the cursor immediately after the \$ character, or within the name of a variable, or immediately after the name of a variable.)

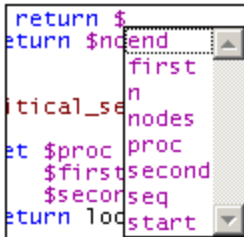

To insert a variable after the \$ character (when typing), or to replace a selected variable, double-click the variable you want in the pop-up menu.

Functions

Just as with keywords and variables, a pop-up menu of built-in functions is displayed when you select a function (displayed in olive) and press **Ctrl+Space**. (A function is selected when you place the cursor within a function name, or immediately before or after a function name. The cursor must not be placed between the parentheses that follow the function's name.) Double-clicking a function name in the pop-up menu replaces the selected function name with the function from the pop-up menu.

To display a tip containing the signature of a function (*screenshot below*), place the cursor immediately after the opening parenthesis and press **Ctrl+Space**. Note that the signature can be displayed only for standard XQuery functions.

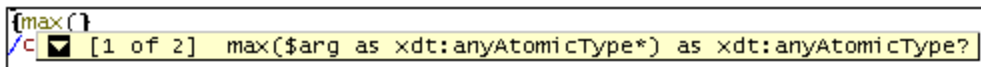

The downward-pointing arrowhead indicates that there is more than one function with the same name but with different arguments or return types. Click on the arrowhead to display the signature of the next function (if available); click repeatedly to cycle through all the functions with that name. Alternatively, you can use the **Ctrl+Shift+Up** or **Ctrl+Shift+Down** key-combinations to move through a sequence.

Visual guides

Text folding (or source folding) is enabled on XQuery curly braces, XQuery comments, XML elements, and XML comments, and refers to the ability to expand and collapse these nodes. Such nodes are indicated in the source folding margin by a +/- sign (see *screenshot below*). The margin can be toggled on and off in the [Text View Settings dialog](#)⁹⁹⁵. When a node is collapsed, this is visually indicated by an ellipsis (see *screenshot below*). If the mouse cursor is placed over an ellipsis, the content of the collapsed node is displayed in a popup

(see *screenshot*). If the content is too large for a popup, this is indicated by an ellipsis at the bottom of the popup.

```

declare function math:EulerSum( $k )
{
  ...;
  sum( for $i in ( 1 to $k ) return 1 div ( $i * $i ) )
}
declare function math:Pi_Euler( $k )
{
  math:sqrt( 6 * math:EulerSum( $k ) )
};

```

The **Toggle All Folds** icon  in the Text toolbar toggles **all** nodes to their expanded forms or collapses all nodes to the top-level document element.

The following options are available when clicking on the node's +/- icon:

Click [-]	Collapses the node.
Click [+]	Expands the node so that descendant nodes are shown expanded or collapsed according to how they were before the node was collapsed.
Shift+Click [-]	Collapses all descendant nodes, but leaves the node that was clicked in its expanded form.
Ctrl+Click [+]	Expand the clicked node as well as all its descendant nodes.

8.2 XQuery Evaluation

XQuery expressions can be evaluated against one or more documents in the XPath/XQuery Output Window (screenshot below).

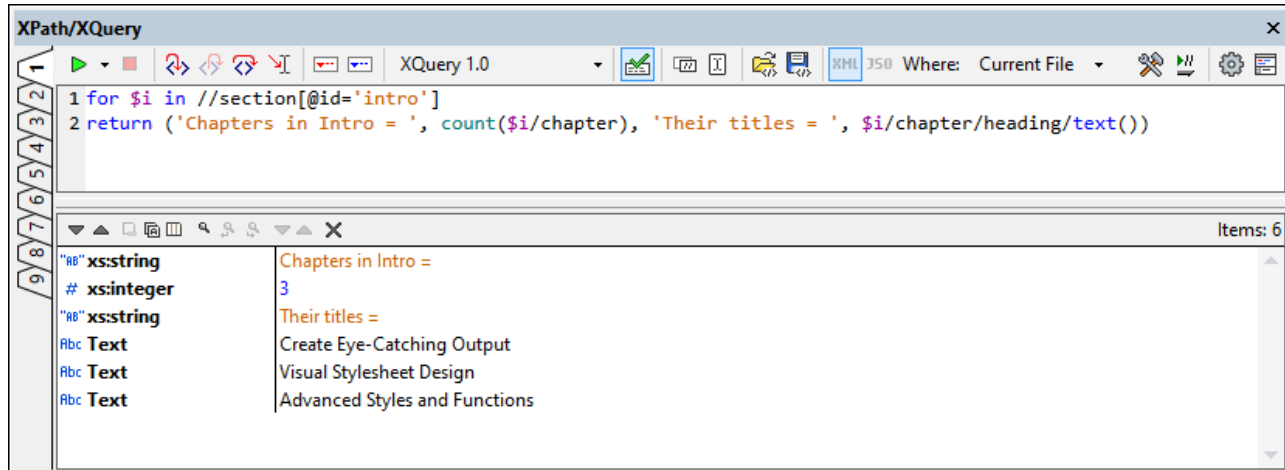

Do this as follows:

1. Enter the XQuery expression in the top pane of the window.
2. In the *Where* combo box (see screenshot above), select where the XML document to be queried is located. The options are: (i) Current file; (ii) Open files; (iii) Project; (iv) Folder.
3. Click **Evaluate XPath/XQuery Expression (F5)**. The expression is evaluated against the XML file/s. If the specified (*Where*) location contains more than one XML file, all the XML files are searched for data structures or content matching the expression. Results of all available matches are displayed in the lower pane.

In the screenshot above, a query is made for a section element that has the attribute `@id='intro'`. The query returns the number of sub-sections of this `intro` section, and their titles.

For more information, see also [Output Window: XPath/XQuery](#)¹¹⁵ and [Previewing and Applying XQuery Updates](#)³⁶⁷.

8.3 XQuery Validation

To validate an XQuery or XQuery Update document, do the following:

1. Make the XQuery document the active document.
2. Select **XML | Validate**, or press the **F8** key, or click the **Validate** toolbar icon.



Validate toolbar icon

The document will be validated for correct XQuery syntax.

8.4 XQuery/Update Execution

An XQuery or XQuery Update document can be run in the following ways:

- When the XQuery or XQuery Update document is active.
- When an XML document is active.

Note: Whether a document is an XQuery document or XQuery Update document is determined by the document's file extension. XMLSpy recognizes file type associations according to the definitions made in Filetypes section of the Options dialog. ([Tools | Options | Filetypes](#)¹⁰⁴³).

Note: For XQuery Update, you can also enter Update expressions in the XPath/XQuery output window and preview updates. If the updates are acceptable, you can apply the updates and then save the updated file. See [XQuery Update Facility](#)³⁸⁷ and [Previewing and Applying Updates](#)³⁸⁷ for more details.

Execution with XQuery or XQuery Update document active

To execute an XQuery or XQuery Update document with the *XQuery / XQuery Update document active*, do the following

1. Make the XQuery or XQuery Update document the active document.
2. Select **XSL/XQuery | XQuery/ Update Execution** or click the command's toolbar icon. This opens the Define an XML or JSON Input for the XQuery dialog (*screenshot below*).

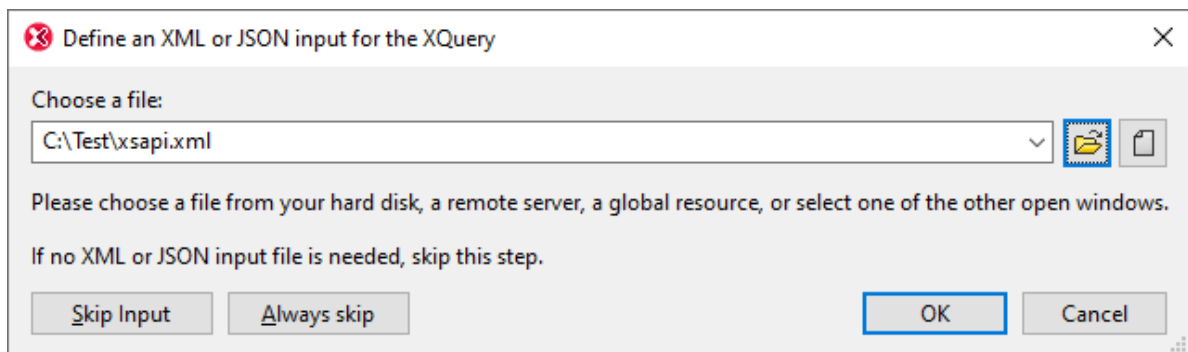

3. Either browse for an XML/JSON file and execute, or skip the selection of an XML source.



XQuery/ Update Execution toolbar icon

Typically, an XQuery document is **not** associated with a specific XML/JSON document. (However, an association might be made with the XQuery `doc()` function.) In XMLSpy, before executing individual XQuery documents you can select a source XML/JSON document for the execution. In such cases, the document node of the selected source is the starting context item of the XQuery document.

Note: The **XQuery/ Update Execution** command is also available in the context menu of [Project Window](#)¹¹⁰ items.

Result of execution / update

- *XQuery execution*: The result document is generated as a temporary file that can be saved to any location with the desired file format and extension.
- *XQuery update*: The update is saved to file, or the updated file is opened, allowing you to preview it, and then either save or close without saving. You can specify which of the two actions to carry out. This is done in the the *XQuery* section of the Options dialog ([Tools | Options | XQuery](#)¹⁰⁷¹).

Execution with XML document active

To execute an XQuery or XQuery Update document on an *active XML document*, do the following

1. Make the XML document the active document.
2. Select **XSL/XQuery | XQuery/ Update Execution** or click the command's toolbar icon. This opens the Choose XQuery/Update File dialog (*screenshot below*).

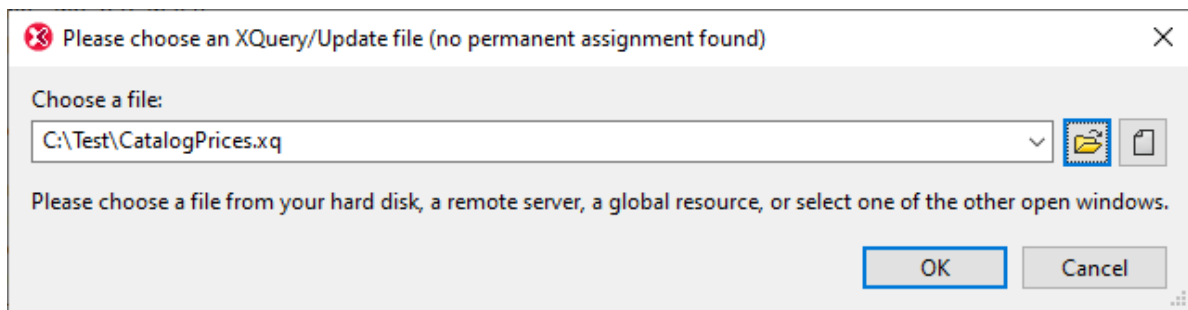

3. Browse for the XQuery or XQuery Update file and click **OK**.



XQuery/ Update Execution toolbar icon

Result of execution / update

- *XQuery execution*: The result document is generated as a temporary file that can be saved to any location with the desired file format and extension.
- *XQuery update*: The update is saved to file, or the updated file is opened, allowing you to preview it, and then either save or close without saving. You can specify which of the two actions to carry out. This is done in the the *XQuery* section of the Options dialog ([Tools | Options | XQuery](#)¹⁰⁷¹).

XQuery Variables

If you are using the Altova XQuery engines, XQuery variables can be stored in a convenient GUI dialog. All the stored variables are passed to the XQuery document each time you execute an XQuery document via XMLSpy. For more information, see the description of the [XSLT Parameters / XQuery Variable](#)⁹¹⁰ command.

Altova XQuery Engines

For details about how the Altova XQuery Engines are implemented and will process XQuery files, see [XQuery Engine Implementation](#)¹⁵⁴⁴.

8.5 XQuery Update Facility

The XQuery Update Facility is an extension of the XQuery language that enables parts of XML documents to be modified. In normal XQuery execution, the entire document is regenerated, and has to be stored back to its location. This could be inefficient when only small parts of the document need to be modified. With the Update Facility, only those parts of the document that need to be modified are updated.

The XQuery Update Facility is described as extensions to XQuery 1.0 and XQuery 3.1, in the following specifications, respectively:

- [XQuery Update Facility 1.0 \(W3C Recommendation of 17 March 2011\)](#)
- [XQuery Update Facility 3.0 \(W3C Working Draft of 19 February 2015\)](#)

The XQuery Update Facility in XMLSpy

The following points explain how XQuery Update works in XMLSpy:

- An update is carried out by an update expression. For example, an update expression can specify that a node in an XML document is renamed:
`rename node /documents/doc-01 as "document-01"`
- In practice, multiple update expressions are entered in a single document—the XQuery Update document.
- As each update expression in the update document executes, the result is not applied immediately, but is added to a *Pending Updates List (PUL)*. As a result, the PUL contains the results of all the update expressions. All updates in the PUL are then applied all together at once.
- In XMLSpy, the PUL updates are applied in one of two ways:
 - (i) *After being previewed by the user in the GUI. The advantage is that the update can be aborted if the preview shows undesirable results. Previewing is available on running the [XQuery/Update Execution command](#)³⁸⁵, or on evaluating XQuery Update expressions in the [XPath/XQuery output window](#)³⁸⁷. How to set the preview option is explained in the respective descriptions.*
 - (ii) *Directly and without any user intervention. The advantage is that the update is carried out silently without requiring user intervention. The direct application of updates (without a preview) is available on running the [XQuery/Update Execution command](#)³⁸⁵, or on evaluating XQuery Update expressions in the [XPath/XQuery output window](#)³⁸⁷. How to set the direct-update option is explained in the respective descriptions.*

XMLSpy provides a powerful XQuery Update Preview feature, which enables you to preview the effect of update expressions on the active XML document and then apply it. This feature is described the section [Previewing and Applying Updates](#)³⁸⁷.

8.5.1 Previewing and Applying Updates

If you wish to modify an XML document using XQuery Update, you can preview updates before applying them to the XML document and saving the modified document.

In the XPath/XQuery output window (*screenshot below*), you can enter one or more update expressions and then preview updates in the **pending update list (PUL)** that is displayed in the bottom pane (*see screenshot below*). If the PUL is as you want it, you can apply the updates to the document and then save the modified

document. If you wish not to go ahead with the modifications in the PUL, you can choose either to not apply modifications or to not save the file.

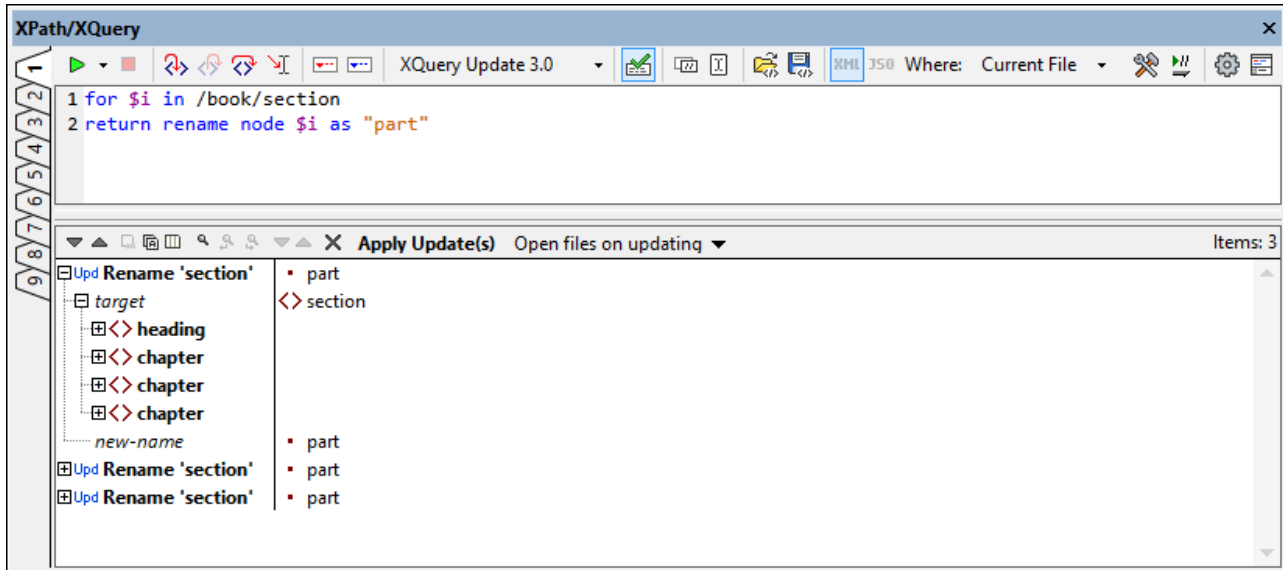



To create a PUL for an active XML file, do the following:





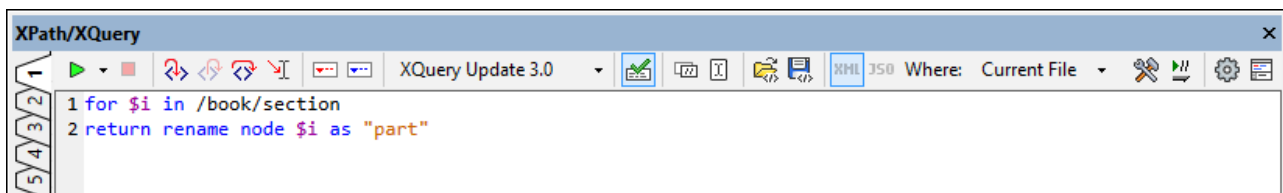





1. In the toolbar of the XPath/XQuery output window (*screenshot above*), select either the **XQU 1.0** or **XQU 3.0** icon (respectively for XQuery Update 1.0 or XQuery Update 3.0).
2. Enter one or more update expressions in the top pane of the window. For a description of update expressions and their syntax, see the section, [Update Operations and Syntax](#)³⁹⁰.
3. In the toolbar's *Where* combo box, select the location to be scanned for the updates:
 - Current file*: Only the currently active file is scanned. If the location selected for scanning is *Current file*, then the **Evaluate XPath/XQuery Expression on Typing** toolbar icon is enabled
 - Open files*: All files that are currently open in XMLSpy will be scanned
 - Project*: The currently active project is scanned
 - Folder*: You can select a folder to scan
4. To execute the update expression/s and display the PUL, click the **Evaluate XPath/XQuery Expression** toolbar icon.

XPath/XQuery output window toolbar

The toolbar commands of the XPath/XQuery output window (*screenshot below*) are described in the table below.



	Start Evaluation/Debugging (F5)	Enables selection of Evaluation Mode, and starts the evaluation
---	--	---

	Stop Evaluation/Debugging (Shift+F5)	Enabled during evaluation. It is useful if the evaluation takes very long or goes into an endless loop, and you therefore want to stop the evaluation
	Validate XML	When toggled on, the target XML document/s are validated
	Copy XPath of Current Selection	Copies the locator path of the node in the XML document to the last cursor position in the Expression pane
	Set current selection as context	Toggles expression context between root node and the current selection
	Load Snippet	Loads an XPath/XQuery snippet from an XQuery file to the evaluator pane, overwriting the current contents of the pane
	Save Snippet	Saves an XPath/XQuery snippet from the evaluator pane to an XQuery file
	XML/JSON Evaluation Mode (toggles between XML and JSON evaluation modes)	The highlighted icon of the pair is the active option. When evaluation scope is multiple files, both icons are enabled and one can be selected. Otherwise, evaluation mode is auto-detected according to file type; the other icon is disabled.
	Switch to Builder	Switches to Expression Builder mode, which provides context-sensitive entry helpers to help construct expressions
	Evaluation on typing	Switches on the evaluation of expressions while the expression is being typed
	Show Options	Opens an Options dialog for setting the display options of results
	Horizontal/Vertical Layout	Switches between horizontal and vertical layouts

The Pending Update List (PUL) pane

The PUL pane shows all the updates that will be carried out. If the Show Header option has been toggled on in the window's toolbar, the locations of target files are displayed. The PUL display is divided into three vertical sections (*see screenshot below*): (i) the update action to carry out; (ii) the content of the target node to be updated; (iii) the update action result.

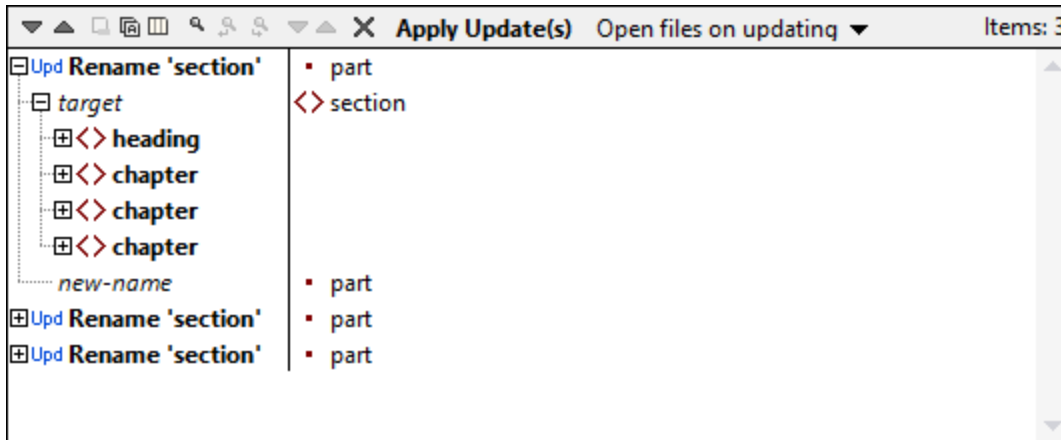

The following PUL pane toolbar commands are available:

- The *Next* and *Previous* icons select, respectively, the next and previous messages to the currently selected message.
- The *Copy Selected Line* and *Copy All Messages* commands copy, respectively, the selected line and all messages to the clipboard.
- The *Copy Includes All Columns* command is a toggle command that switches on/off the copying of all columns.
- The *Find* commands find text in the PUL pane.
- The *Expand with Children* command expands the selected node and all its descendants.
- The *Collapse with Children* command collapses the selected node and, within it, all its descendants.
- The *Clear* command deletes all lines in the PUL pane.
- The *Apply Update(s)* command applies the pending updates to the target locations. On updating, the updates can be saved to file, or the updated file can be displayed (and subsequently saved manually or not). See the next option.
- The *Open Files on Updating* combo box allows you to select (i) whether updated files are opened and made active in XMLSpy, or (ii) whether files are updated silently on disk. If the former option is selected, then non-open or non-active target files are opened and/or are made active. You then have the choice of saving the modified document or not.

Note: If one or more files have been updated directly on disk, a list of changed files is displayed. each item in the list shows the location of the file and is a clickable link to the file.

8.5.2 Update Operations and Syntax

The XQuery Update Facility enables the following operations:

- [Delete](#)³⁹¹ one or several nodes
- [Insert](#)³⁹¹ one or more nodes before, after, or inside a specified node
- [Rename](#)³⁹² a node
- [Replace](#)³⁹² a node with a sequence of items
- [Replace Value](#)³⁹³ of a node with the string value of a sequence of items

The keywords and syntax of these operations are described in the sub-sections of this section.

8.5.2.1 Delete Nodes

Description and syntax

Deletes one or more nodes.

```
delete node nodeSequence
delete nodes nodeSequence
```

Details

- The expression *nodeSequence* returns a sequence of the node/s to delete. All selected nodes will be marked for deletion.
- It does not matter whether the singular *node* or plural *nodes* is used. No correspondence is needed with the number of items in *nodeSequence*.

Examples

```
for $i in /book/section return
delete nodes $i/@id
```

8.5.2.2 Insert Nodes

Description and syntax

Inserts one or more nodes before, after, or inside the specified target node.

```
insert (node|nodes) items into targetNode
insert (node|nodes) items as first into targetNode
insert (node|nodes) items as last into targetNode
insert (node|nodes) items before targetNode
insert (node|nodes) items after targetNode
```

Details

- The expression *items* must return a sequence of items. Even though the keyword *node|nodes* is used, *items* can be a sequence of non-node items.
- The expression *targetNode* must point to a single target node.
- If the keyword *into* is used, *targetNode* must be an element node or document-element node.
- If the keyphrase *as first* or *as last* is used, the insertion is as first or last children, respectively.
- If the keyword *into* is used alone, then attributes are appended to existing attributes, and elements are inserted as first children.
- If the keyword *before* or *after* is used, *targetNode* can be of any type.
- If an attribute is being inserted, its name must not duplicate that of an already existing attribute.

Examples

```
for $i in /book/section return
insert nodes (attribute id { 'somevalue' }, <newelement>some content including the numbers
"{ 1 to 3}"</newelement>)
into $i
```

8.5.2.3 Rename Node

Description and syntax

Renames an element, attribute, or processing instruction node.

```
rename node targetNode as name
```

Details

- The expression *targetNode* must point to a single target node, which can be an element, attribute, or processing instruction.
- The expression *name* must evaluate to a QName or string.
- If a QName is constructed, the mandatory namespace is declared locally.

Examples

```
rename node /book/title as 'header-1'
```

```
rename node /book/title as QName("http://www.altova.com/xquf", "header-1")
```

8.5.2.4 Replace Node

Description and syntax

Replaces a node with a sequence of any kind of items.

```
replace node targetNode with items
```

Details

- The expression *targetNode* must point to a single target node.
- The expression *items* must return a sequence of items. This sequence will replace the target node.
- Except for attribute nodes, a target node can be replaced by any type of sequence.
- An attribute node can only be replaced with an attribute node. *See example below.*

Examples

```
replace node //hr with '<line/>'
```

```
for $i in //@height return
replace node $i with (attribute line-height{'12pt'})
```

8.5.2.5 Replace Value of Node

Description and syntax

Replaces the value of a node with the string value of a sequence of items.

```
replace value of node targetNode with items
```

Details

- The expression *targetNode* must point to a single target node.
- The expression *items* must return a sequence of items.
- The contents of the target node are replaced by the string value of the sequence returned by the *items* expression. This means that the target node will contain one text node only.

Examples

```
for $i in //title return
replace value of node $i with ('Draft Title')
```

8.5.2.6 The fn:put Function

The **fn.put** function is provided by XQuery Update Facility 1.0 as an extension to the XQuery built-in function library. (The **fn:** namespace prefix in this section is assumed to be bound to the namespace: <http://www.w3.org/2005/xpath-functions>.)

```
fn:put($node as node(), $uri as xs:string) as empty-sequence()
```

The function stores a document or element to the location specified by *\$uri*. It is normally invoked to create a resource on an external storage system such as a file system or a database. The external effects of **fn:put** are implementation-defined, since they occur outside the domain of XQuery. The intent is that, if **fn:put** is invoked on a document node and no error is raised, a subsequent query can access the stored document by invoking **fn:doc** with the same URI.

See the [specification](#) for more details.

8.6 XQuery and XML Databases

An XQuery document can be used to query an XML database (XML DB). Currently this XQuery functionality is supported only for IBM DB2 databases. The mechanism for querying an XML DB using XQuery essentially involves: (i) indicating to the XQuery engine that XML in a DB is to be queried—as opposed to XML in an XML document; and (ii) accessing the XML data in the DB.

The steps for implementing this mechanism are as follows and are described in detail below:

1. [Set up the XQuery document](#)³⁹⁴ to query the XML DB by inserting the `XQUERY` keyword at the start of the document.
2. For the active XQuery document, [enable DB support](#)³⁹⁴ (via the Info window) and [connect to the DB](#)³⁹⁴ (using the Quick Connect dialog).
3. In the XQuery document, insert [DB-specific XQuery extensions](#)³⁹⁵ so as to access the DB data and make it available for XQuery operations.
4. [Execute the XQuery](#)³⁹⁴ document in XMLSpy.

Setting up the XQuery document to query the XML DB

To set up the XQuery document to query an XML DB, open the XQuery document (or create a new XQuery document) and enter the keyword `XQUERY` (casing is irrelevant) at the start of the document (before the prolog); *see examples below*.

```
XQUERY (: Retrieve details of all customers :)
declare default element namespace "http://www.altova.com/xquery/databases/db2";
<a> {db2-fn:xmlcolumn("CUSTOMER.INFO")} </a>
```

If the document uses the optional `xquery version` expression, the `XQUERY` keyword is still required:

```
XQUERY xquery version "1.0"; (: Retrieve details of all customers :)
declare default element namespace "http://http://www.altova.com/xquery/databases/db2";
<a> {db2-fn:xmlcolumn("CUSTOMER.INFO")} </a>
```

Note: XMLSpy's built-in XQuery Engines read the `XQUERY` keyword as indicating that an XML DB is to be accessed. As a result, attempting to execute an XQuery document containing the `XQUERY` keyword on any XML document other than one contained in an XML DB will result in an error.

Enable DB support for XQuery and connect to the DB

DB support for an XQuery document is enabled by checking the Enable Database Support check box in the Info window (*screenshot below*). Note that DB Support must be enabled for each XQuery document separately and each time an XQuery document is opened afresh.

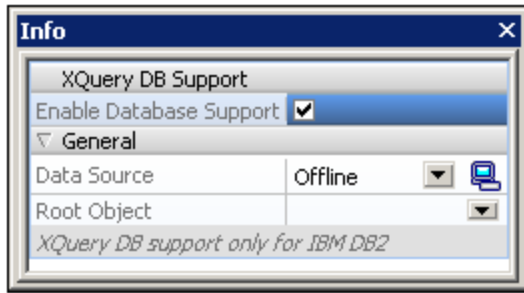

When you enable DB support in the Info window, a Quick Connect dialog pops up, which enables you to connect to a database. Currently, only IBM DB2 databases are supported. How to connect to a DB is described in the section, [Connecting to a Database](#)⁶⁰⁹. If connections to data sources already exist, then these are listed in the Data Sources combo box of the Info window (*screenshot below*), and one of these data sources can be selected as the data source for the active XQuery document. In the Info window, you can also select the root object from among those available in the Root Object combo box.

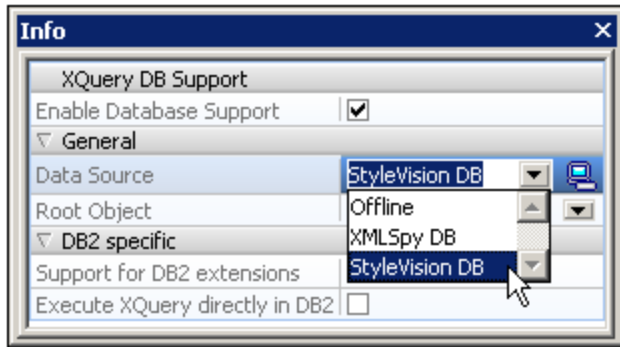

The Quick Connect dialog (which enables you to connect to a DB) can be accessed at any time by clicking the  icon in the Info window.

Note: When you close an XQuery document the connection to the DB is closed as well. If you subsequently re-open the XQuery document, you will also have to re-connect to the DB.

IBM DB2-specific XQuery language extensions

Two IBM DB2-specific functions can be used in XQuery documents to retrieve data from an IBM DB2 database:

- `db2-fn:xmlcolumn` retrieves an entire XML column without searching or filtering the column.
- `db2-fn:sqlquery` retrieves values based on an SQL `SELECT` statement

The XML data retrieved using these functions can then be operated on using standard XQuery constructs. See *examples below*.

db2-fn:xmlcolumn: The argument of the function is a case-sensitive string literal that identifies an XML column in a table. The string literal argument must be a qualified column name of type XML. The function returns all the XML data in the column as a sequence, without applying a search condition to it. In the following example, all the data of the `INFO` (XML) column of the `CUSTOMER` table is returned within a top-level `<newdocelement>` element:

```
XQUERY (: Retrieve details of all customers :)
declare default element namespace "http://www.altova.com/xquery/databases/db2";
<newdocelement> {db2-fn:xmlcolumn("CUSTOMER.INFO")} </newdocelement>
```

The retrieved data can then be queried with XQuery constructs. In the example below, the XML data retrieved from the `INFO (XML)` column of the `CUSTOMER` table is filtered using an XQuery construct so that only the profiles of customers from Toronto are retrieved.

```
XQUERY (: Retrieve details of Toronto customers :)
declare default element namespace "http://www.altova.com/xquery/databases/db2";
<newdocelement> {db2-fn:xmlcolumn("CUSTOMER.INFO")/customerinfo[addr/city='Toronto']}
</newdocelement>
```

Note: In the example above, the document element of the XML files in each cell is `customerinfo` and the root node of the XML sequence returned by `db2-fn:xmlcolumn` is considered to be an abstract node above the `customerinfo` nodes.

db2-fn:sqlquery: The function takes an SQL Select statement as its argument and returns a sequence of XML values. The retrieved sequence is then queried with XQuery constructs. In the following example, the `INFO` column is filtered for records in the `CUSTOMER` table that have a `CID` field with a value between 1000 and 1004. Note that while SQL is not case-sensitive, XQuery is.

```
XQUERY (: Retrieve details of customers by Cid:)
declare default element namespace "http://www.altova.com/xquery/databases/db2";

<persons>
  {db2-fn:sqlquery("SELECT info FROM customer WHERE CID>1000 AND CID<1004")}/
  <person>
    <id>{data(@Cid)}</id>
    <name>{data(name)}</name>
  </person>
</persons>
```

The XQuery document above returns the following output:

```
<persons xmlns="http://www.altova.com/xquery/databases/db2">
  <person>
    <id>1001</id>
    <name>Kathy Smith</name>
  </person>
  <person>
    <id>1002</id>
    <name>Jim Jones</name>
  </person>
  <person>
    <id>1003</id>
    <name>Robert Shoemaker</name>
  </person>
</persons>
```

Note the following points:

- The default element namespace declaration in the prolog applies for the entire XQuery document and is used for navigation of the XML document as well as for construction of new elements. This means that the XQuery selector `name` is expanded to `<default-element-namespace>:name`, and that constructed elements, such as `persons`, are in the default element namespace.
- The SQL Select statement is not case-sensitive.
- The `WHERE` clause of the Select statement should reference another database item—not a node inside the XML file being accessed.
- The `"/` after the `db2-fn:sqlquery` function represents the first item of the returned sequence, and this item is the context node for further navigation.

Execute the XQuery

To execute the XQuery document, select the **XQuery Execution** command (**XSL/XQuery** menu).

Alternatively, press **Alt+F10** or click the XQuery Execution icon . The result of the execution is displayed in a new document.

9 XSLT/XQuery Debugger and Profiler

XMLSpy contains an [XSLT/XQuery Debugger](#)³⁹⁹ to help you create correct XSLT and XQuery documents faster. These two features are described in the sub-sections of this section.

Note: XSLT Profiler is available in the Enterprise Edition only.

9.1 XSLT and XQuery Debugger

The XSLT/XQuery Debugger enables you to debug XSLT stylesheets and XQuery documents. It presents simultaneous views of the XSLT/XQuery document, the source XML/JSON document, and the output document. You can go step-by-step through the XSLT/XQuery document to see what output is generated at each step. At each step, the corresponding positions in the source XML/JSON document, the XSLT/XQuery document, and the output document are highlighted, and debugging information is displayed in ancillary windows of the debugger.

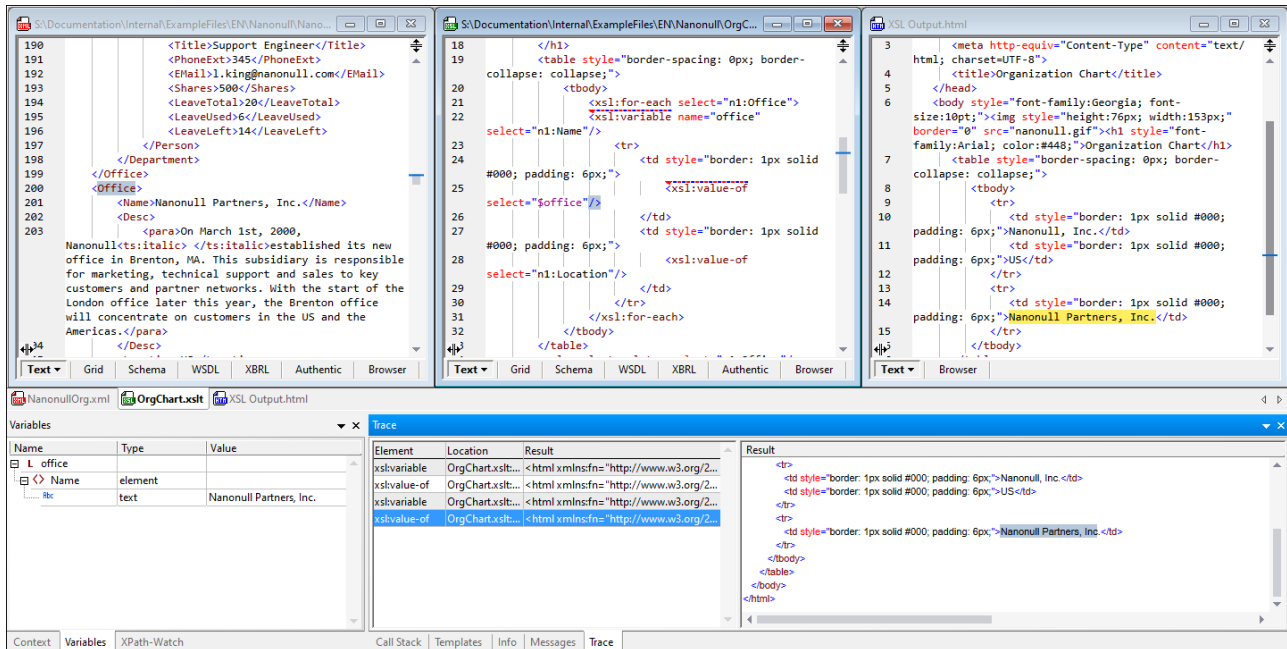

This section describes how to work with XSLT/XQuery Debugger and is organized into the following topics:

- [Mechanism and Interface](#) ⁴⁰⁰
- [Commands and Toolbar Icons](#) ⁴⁰²
- [Breakpoints](#) ⁴⁰⁴
- [Tracepoints](#) ⁴⁰⁶
- [Information Windows](#) ⁴¹⁰
- [Debugger Settings](#) ⁴¹⁷

Altova website: [XSLT Debugger](#), [XQuery Debugger](#)

9.1.1 Mechanism and Interface

The broad mechanism used for debugging XSLT and XQuery files is given below.

Open a debugging session

You can open a debugging session from an XML, JSON, XSLT, or XQuery document by selecting the **XSL/XQuery | Start Debugger / Go** command.

The XSLT/XQuery Debugger works only in Text View and Grid View. If the active document is not in Text View or Grid View when you start the debugging session, then you will be prompted for permission to change to Text View, which is the default view of the XSLT/XQuery Debugger. You can, in the [Debugger Settings dialog](#)⁴¹⁷, also choose to set this option permanently.

If the active document requires an associated file and if this file has been assigned to the active file, then the debugging session is started immediately. (For example, an XML document could have an XSLT stylesheet assigned to it via an `xml-stylesheet` processing instruction.) Otherwise, you are prompted to select the required associated file. Note, however, that since XQuery files neither require nor contain an XML/JSON file association, you can choose to be prompted for an optional XML/JSON file association or not each time you start an XQuery debugging session (see *screenshot below*).

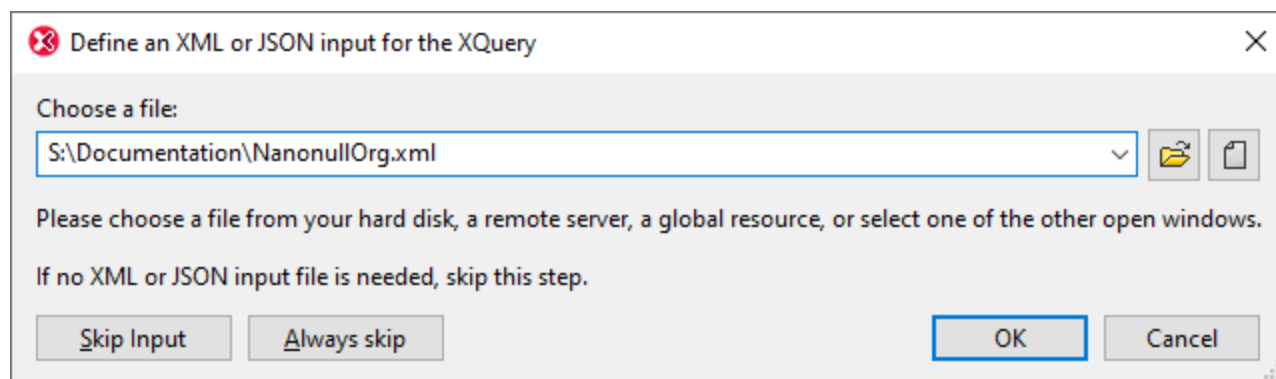

The Debugger toolbar with [Debugger icons](#)⁴⁰² appears automatically when a debugging session is started.

Debugger interface

The XSLT/XQuery Debugger interface is shown in the diagram below. Alternatively to the view of the three documents (XML/JSON, XSLT/XQuery, Output) shown below, you can opt for a view of two documents (XSLT/XQuery and Output) or a view of any one of the documents. To do this, select the appropriate command from among the [Debugger's three view commands](#)⁴⁰².

XMLSpy Menu Bar		
Toolbar icons, including Debugger icons		
XML/JSON Document	XSLT/XQuery Document	Output File
Context (XSLT only) Variables XPath Watch	Call Stack Messages Templates (XSLT only) Info	

Information windows in the interface (see *screenshot above*) provide information about various aspects of the transformation/execution (Variables, XPath Watch, Call Stack, Messages, Info, etc). See the topic [Information Windows](#)⁴¹⁰ for details.

Debugging

There are two broad ways to go through the XSLT or XQuery document:

- Use the **XSL/XQuery | Start Debugger / Go** command to go through the entire transformation/execution, stopping only at breakpoints. If no breakpoint has been set, then the transformation/execution is carried out in one step and no debug results are shown.
- Use the **Step Into**, **Step Out**, and **Step Over** commands to step through the XSLT or XQuery document. If an XML file is associated with the session, the corresponding locations in the XML file are highlighted. Simultaneously, output for corresponding steps is generated in the output file. Consequently, you can see what is happening at each step of the transformation and note any effects you might want to change.

Breakpoints can be set in any of the documents (XML or XSLT/XQuery) to interrupt the processing at selected points. This speeds up debugging sessions since you do not need to step through each statement in the XSLT or XQuery document. See the topic [Breakpoints](#)⁴⁰⁴ for more information. Additionally, tracepoints can be set in the XML/JSON or XSLT/XQuery documents to separately view the output of individual instructions. See the topic [Tracepoints](#)⁴⁰⁶ for more information.









During a debugging session, you can stop the debugger (not the same as ending the debugging session; see *below*) with the **XSL/XQuery | Stop Debugger** command. When the debugger has been stopped, the XSLT/XQuery Debugger interface stays open and you can edit any of the documents. All XMLSpy editing features will be available for editing in the debugger interface. You can restart the debugger (from the beginning of the XSLT/XQuery document) by selecting **XSL/XQuery | Start Debugger** or **XSL/XQuery | Step Into**.









Stop the debugging session

Select **XSL/XQuery | End Debugger Session** to close a debugging session and return you to your previous XMLSpy environment. The information windows will be closed, but breakpoint and tracepoint information is held till the file is closed. (As a result, if you start another debugging session involving a file containing breakpoints, the breakpoints will apply in the newly opened debugging session.)

9.1.2 Commands and Toolbar Icons

Debugger commands are available in the **XSL/XQuery** menu and as toolbar icons. The debugger icons are automatically made available in the toolbar when a debugging session is opened. The debugger icons are listed below.

Icon	Command Name	Description
	<i>Start Debugger/Go (Alt+F11)</i>	Starts or continues debugging till the end. If breakpoints ⁴⁰⁴ have been set, then is paused at breakpoints. Tracepoint results ⁴⁰⁶ are displayed in the Trace window when the tracepoint instruction is carried out.
	<i>View the active document only</i>	Maximizes the window of the currently active document in the debugger.
	<i>View XSLT/XQuery and Output</i>	Displays XSLT/XQuery and output documents while hiding the XML document.
	<i>View XML, XSLT/XQuery and Output</i>	Displays the XML, XSLT/XQuery, and output documents. This is the default view when an XML document is associated for the debugging session.
	<i>Stop Debugger</i>	Stops the debugger. Not the same as stopping the debugger session. This is convenient if you wish to edit a document in the middle of a debugging session. After stopping the debugger, you must restart from the beginning.
	<i>Step into (F11)</i>	Proceeds in single steps through all nodes and XPath expressions. Also used to restart the debugger after it was stopped.
	<i>Step Over (Ctrl+F11)</i>	Steps over the current node to the next node at the same level, or to the next node at the next higher level from that of the current node. Also used to restart the debugger after it was stopped.
	<i>Step Out (Shift+F11)</i>	Steps out of the current node to the next sibling of the parent node, or to the next node at the next higher level from that of the parent node.

	<i>Show current execution node</i>	Displays/selects the current execution node in the XSLT/XQuery document and the corresponding context node in the XML document. Useful if you click in other tabs or go to specific document locations and then want to return to the current node of the debugging.
	<i>Restart Debugger</i>	Clears the output window and restarts the debugging session with the currently selected files.
	<i>Insert/Remove Breakpoint (F9)</i>	Inserts or removes a breakpoint ⁴⁰⁴ at the current cursor position. Indicated by a dashed red line. The command is also available in context menus.
	<i>Insert/Remove Tracepoint (Shift+F9)</i>	Inserts or removes a tracepoint ⁴⁰⁶ at the current cursor position. Inline tracepoints can be defined for nodes in XSLT documents. Indicated by a dashed red line. The command is also available in context menus.
	<i>Enable/Disable Breakpoint (CTRL+F9)</i>	This command (no toolbar icon exists) enables or disables already defined breakpoints ⁴⁰⁴ . The command is also available in context menus.
	<i>Enable/Disable Tracepoint (Shift+CTRL+F9)</i>	This command (no toolbar icon exists) enables or disables already defined tracepoints ⁴⁰⁶ . The command is also available in context menus.
	<i>End Debugger Session</i>	Ends the debugging session and returns you to the XMLSpy view that was active before you started the debugging session. Whether the output documents that were opened for the debugging session stay open depends on a setting you make in the XSLT/XQuery Debugger Settings ⁴¹⁷ dialog.
	<i>Breakpoints/Tracepoints Dialog</i>	This command opens the XSLT/XQuery Breakpoints / Tracepoints dialog, which displays a list of all currently defined breakpoints/tracepoints (including disabled ones) in all files in the current debugging session.

Debugger shortcuts

F9	Insert/Remove Breakpoint
F9 + Shift	Insert/Remove Tracepoint
F9 + CTRL	Enable/Disable Breakpoint
F9 + Shift + CTRL	Enable/Disable Tracepoint
F11	Step Into
F11 + Shift	Step Out
F11 + CTRL	Step Over
F11 + Alt	Start Debugger/Go

9.1.3 Breakpoints

Breakpoints (*dashed red lines in screenshot below*) can be set in XML, XSLT, and XQuery documents. Debugging will pause at breakpoints, which enables you to restrict attention to these areas. You can set any number of breakpoints.

After the debugger pauses on encountering a breakpoint, select **XSL/XQuery | Start Debugger** or **XSL/XQuery | Step Into** to resume debugging.

Note the following points:

- A breakpoint is shown as a dashed red line.
- It is possible to set both a breakpoint and a [tracepoint](#) ⁴⁰⁶ for the same instruction/node. The instruction/node is then marked with a combined dashed blue and dashed red line (*see second breakpoint in screenshot above*).
- Breakpoints that have been set for a document remain in that document until it is closed. If you switch to a view that is not Text View or Grid View, breakpoints will be deleted.

Breakpoint locations

You can set breakpoints at the following locations:

- *XML/JSON documents*: Any node. The break in processing will occur at the start of that node.
- *XSLT documents*: (i) At the beginning of templates and template instructions (e.g., `xsl:for-each`); (ii) On XPath expressions; (iii) On any node in a literally constructed XML fragment. The break in processing will occur at the start of that node.
- *XQuery documents*: (i) At the beginning of XQuery statements, (ii) In XQuery expressions; (iii) On any node in a literally constructed XML fragment. The break in processing will occur at the start of that node.

Note: Breakpoints cannot be defined on closing nodes. Breakpoints on attributes in XSLT documents will be ignored.

Altova XMLSpy 2024 Professional Edition

© 2018-2024 Altova GmbH

Insert and remove breakpoints

Breakpoints can be set in Text View and Grid View. Place the cursor at the point where you wish to insert the breakpoint—or in the breakpoint if you want to remove it—and then do one of the following:

- Select **XSL/XQuery | Insert/Remove Breakpoint**.
- Press **F9**.
- Right-click and select **Breakpoints/Tracepoints | Insert/Remove Breakpoint**.

To remove a breakpoint, you can also use the XSLT Breakpoints/Tracepoints dialog (*described below*).

XSLT Breakpoints/Tracepoints dialog

Access the XSLT Breakpoints/Tracepoints dialog (*screenshot below*) by clicking either the menu command **XSL/XQuery | Breakpoints/Tracepoints...** or the command's toolbar icon.

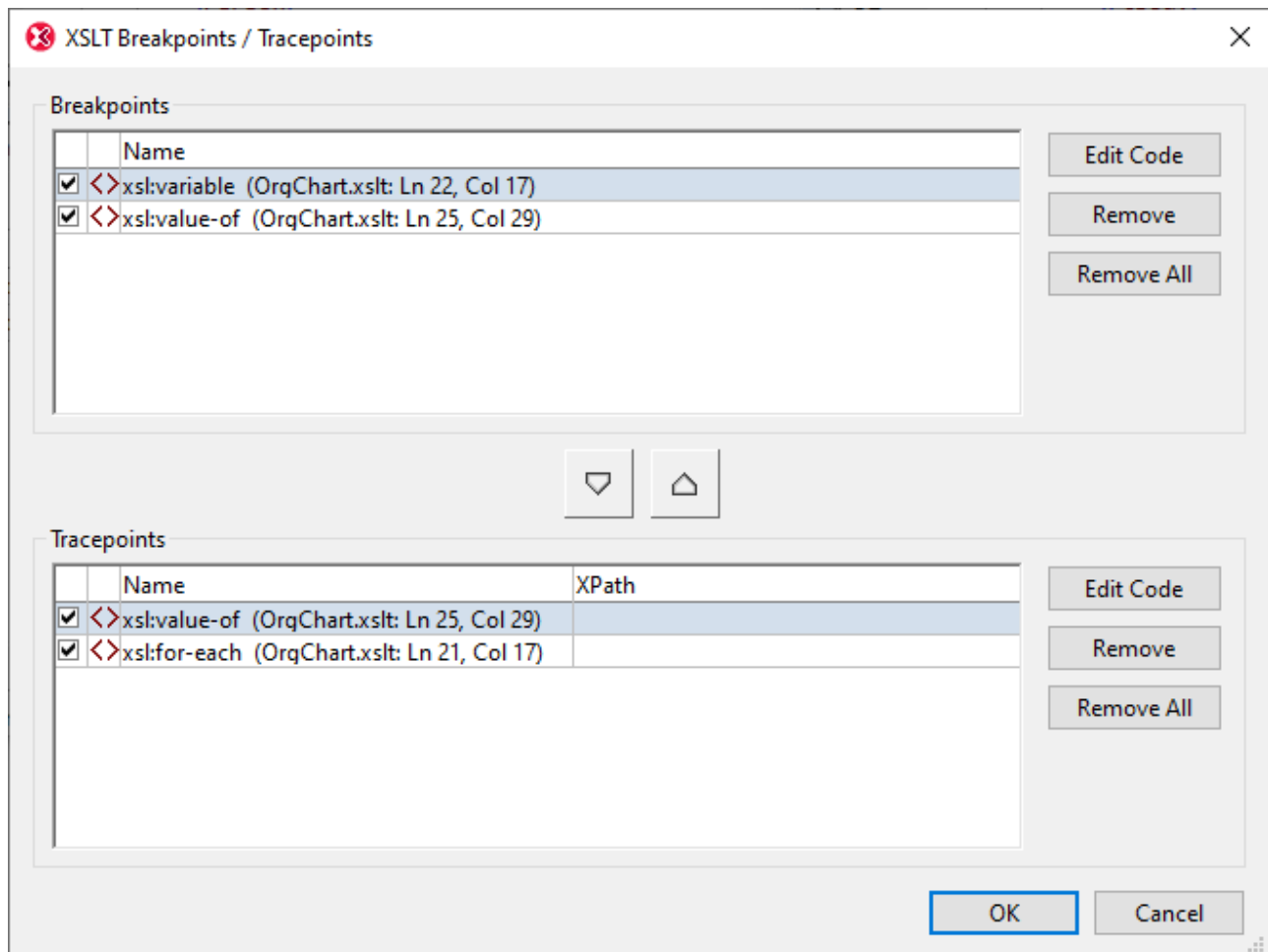

The XSLT Breakpoints/Tracepoints dialog provides the following functionality:

- List all breakpoints and tracepoints in all currently open XML, XSLT, and XQuery documents.
- Change a breakpoint to a tracepoint and vice versa, by using the arrow buttons between the respective

- panes and clicking **OK** when done.
- Disable/enable a breakpoint or tracepoint by, respectively, unchecking/checking its check box and clicking **OK** when done. Disabling a breakpoint or tracepoint enables you to skip over it without having to remove it.
- Remove one or all breakpoints/tracepoints by clicking the respective button and clicking **OK** when done.
- Go directly to the breakpoint/tracepoint in the respective document and edit the document. Click the respective **Edit Code** button (see screenshot below).

9.1.4 Tracepoints

Tracepoints enable you to trace content generated by an XSLT instruction. In the screenshot below, each tracepoint (up to that point in the debugging session) is listed in the *Trace* tab of the Trace window. Select one of the Trace items to show the XSLT content generated at the tracepoint. The content will be displayed in the *Result* pane to the right.

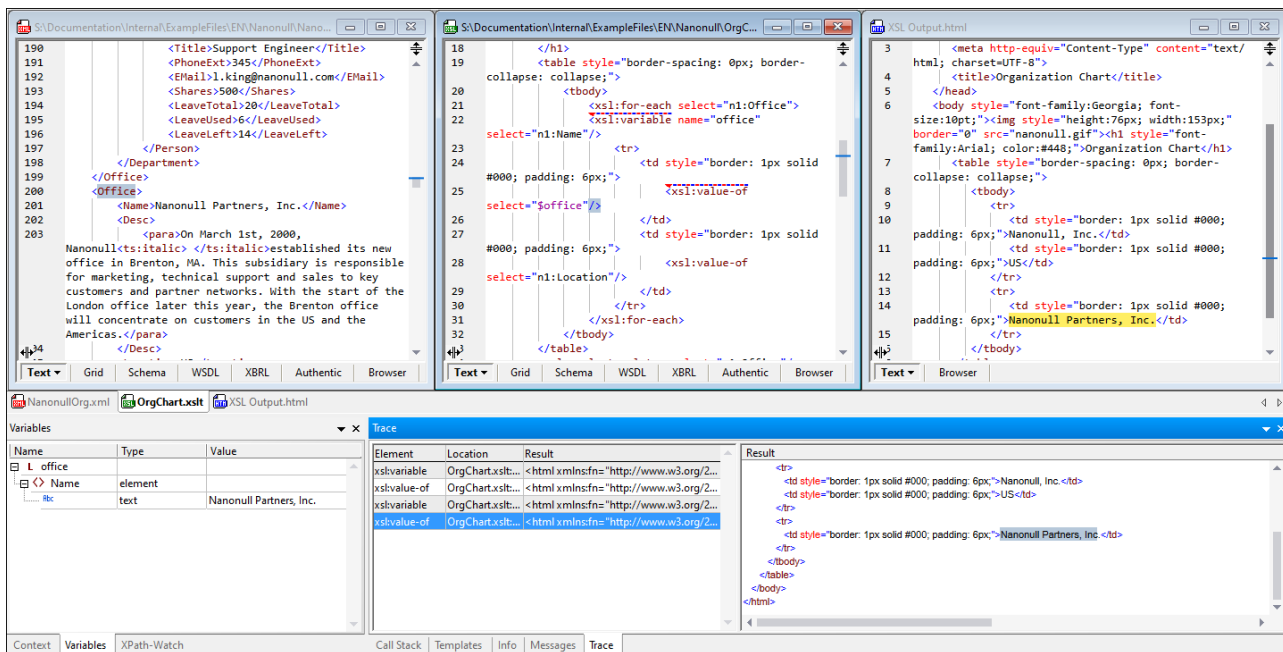

The screenshot above shows that two tracepoints have been set: (i) on the `xsl:variable` and the `xsl:value-of` instructions. Since both these instructions occur inside an `xsl:for-each` instruction that selects the `n1:Office` element, the processor loops through the `n1:Office` elements of the XML document. For each `n1:Office` element, the `$office` variable will be set to the value of the `n1:Name` child element (of the current `n1:Office` element). The `xsl:value-of` instruction outputs the value of the `$office` variable (which will be that of the `n1:Name` element).

In the screenshot, the Debugger has progressed through two `n1:Office` elements. The `xsl:variable` and the `xsl:value-of` instructions are listed for each of the two `n1:Office` elements. Select any of the four items to show, in the *Result* pane, the result generated by that specific instruction.

You can set as many tracepoints as you like. As the debugger progresses through the XSLT document, all encountered tracepoints will be listed in the *Trace* tab, and you can select any of the listed instructions to see the result it generates.

Important points

Note the following points:

- Tracepoints can be set (i) on XSL instructions and literal results in XSLT stylesheets and (ii) on nodes in XML and XQuery documents.
- Tracepoints cannot be defined on closing nodes.
- A tracepoint is shown as a dashed blue line.
- It is possible to set both a tracepoint and a [breakpoint](#)⁴⁰⁴ for the same instruction/node. The instruction/node is then marked with a combined dashed blue and dashed red line (*see screenshot above*).
- Results are displayed in the Trace window only after the traced instruction is completed.
- Tracepoints that have been set for a document remain in that document until it is closed. If you switch to a view that is not Text View or Grid View, tracepoints will be deleted.
- You can also use a tracepoint to see what result would be generated by an XPath expression that has tracepoint node as its context node. How to do this is described below.

Insert and remove tracepoints

Tracepoints can be set in Text View and Grid View. Place the cursor at the point where you wish to insert the tracepoint—or in the tracepoint if you want to remove it—and then do one of the following:

- Select **XSL/XQuery | Insert/Remove Tracepoint**.
- Press **Shift+F9**.
- Right-click and select **Breakpoints/Tracepoints | Insert/Remove Tracepoint**.

To remove a tracepoint, you can also use the XSLT Breakpoints/Tracepoints dialog (*described below*).

XSLT Breakpoints/Tracepoints dialog

Access the XSLT Breakpoints/Tracepoints dialog (*screenshot below*) by clicking either the menu command **XSL/XQuery | Breakpoints/Tracepoints...** or the command's toolbar icon.

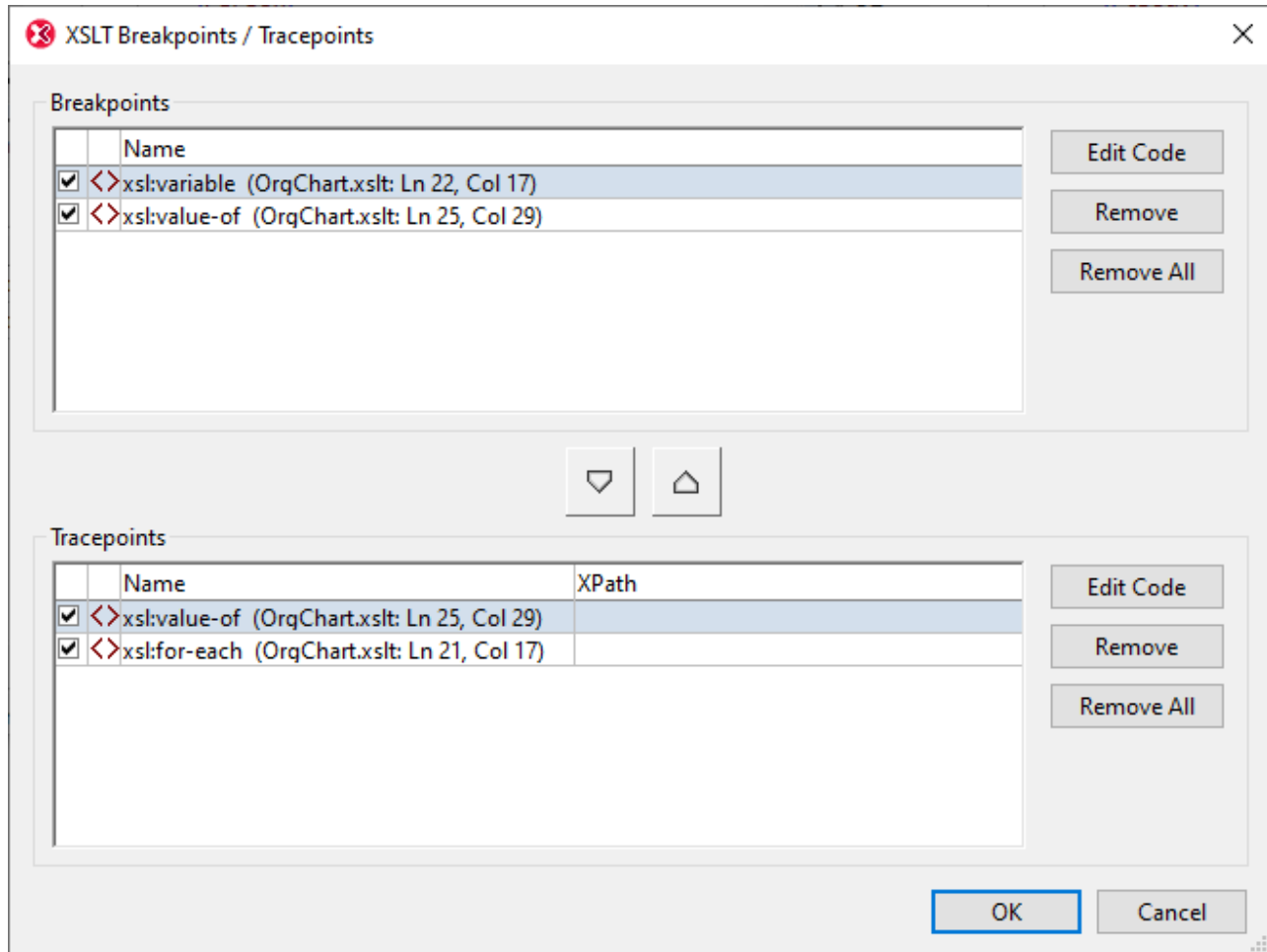

The XSLT Breakpoints/Tracepoints dialog provides the following functionality:

- List all breakpoints and tracepoints in all currently open XML, XSLT, and XQuery documents.
- Change a breakpoint to a tracepoint and vice versa, by using the arrow buttons between the respective panes and clicking **OK** when done.
- Disable/enable a breakpoint or tracepoint by, respectively, unchecking/checking its check box and clicking **OK** when done. Disabling a breakpoint or tracepoint enables you to skip over it without having to remove it.
- Remove one or all breakpoints/tracepoints by clicking the respective button and clicking **OK** when done.
- Go directly to the breakpoint/tracepoint in the respective document and edit the document. Click the respective **Edit Code** button (see screenshot below).
- Set an XPath expression on a tracepoint to check the value the expression returns. How to do this is described below.

Set an XPath expression on a tracepoint

If you set an XPath expression on a tracepoint, the tracepoint does not return the content generated by the corresponding XSLT instruction. Instead, it returns the result of evaluating the XPath expression relative to the context node of the tracepoint. This result is displayed in the Trace window.

For example, in the screenshot below, we have set three tracepoints. The first tracepoint (on line 21) has as its context node the parent node of the `n1:Office` element. The other two tracepoints, because they are inside the `xsl:for-each` instruction, would both have the `n1:Office` element as their respective context nodes.

```

19      <table style="border-spacing: 0px; border-
collapse: collapse;">
20          <tbody>
21              <xsl:for-each select="n1:Office">
22                  <xsl:variable name="office"
select="n1:Name"/>
23                  <tr>
24                      <td style="border: 1px solid
#000; padding: 6px;">
25                          <xsl:value-of
select="$office"/>
26                      </td>

```

Now, let's say we set, in the XSLT Breakpoints/Tracepoints dialog (see above), XPath expressions for each of the three tracepoints as shown in the screenshot below. Note that the context node of the first tracepoint is the parent node of the `n1:Office` element, which enables us to count the `n1:Office` elements as child nodes. For the second tracepoint, where the context node is the `n1:Office` element, we can count child `n1:Department` elements.

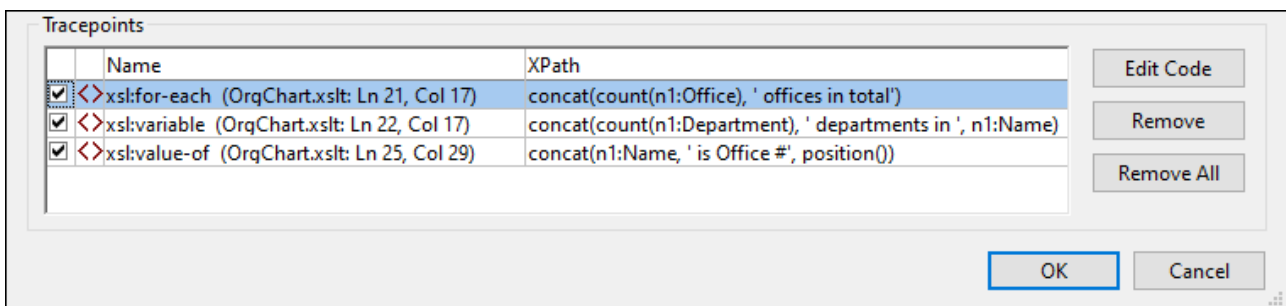

On running the Debugger (**XSL/XQuery | Start Debugger**), the results of the XPath expressions will be displayed in the Trace window (see screenshot below).

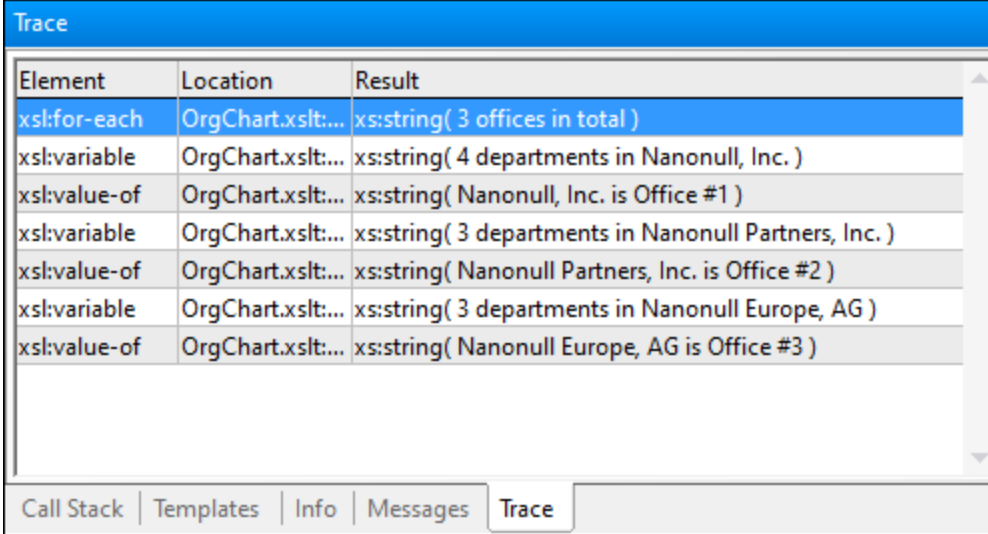

The screenshot shows the 'Trace' window of the XSLT/XQuery Debugger. It contains a table with three columns: 'Element', 'Location', and 'Result'. The table lists seven execution steps, with the first row highlighted in blue. Below the table is a navigation bar with tabs for 'Call Stack', 'Templates', 'Info', 'Messages', and 'Trace'.

Element	Location	Result
xsl:for-each	OrgChart.xslt:...	xs:string(3 offices in total)
xsl:variable	OrgChart.xslt:...	xs:string(4 departments in Nanonull, Inc.)
xsl:value-of	OrgChart.xslt:...	xs:string(Nanonull, Inc. is Office #1)
xsl:variable	OrgChart.xslt:...	xs:string(3 departments in Nanonull Partners, Inc.)
xsl:value-of	OrgChart.xslt:...	xs:string(Nanonull Partners, Inc. is Office #2)
xsl:variable	OrgChart.xslt:...	xs:string(3 departments in Nanonull Europe, AG)
xsl:value-of	OrgChart.xslt:...	xs:string(Nanonull Europe, AG is Office #3)

Note the following points:

- Since there are three `n1:Office` elements in our example, the `xsl:for-each` loop is executed once for each of the `n1:Office` elements. Consequently, the other two tracepoints within the loop are evaluated for each office and return data corresponding to the respective offices.
- The XPath expression of the `xsl:for-each` tracepoint is evaluated when processing of the instruction is completed.

9.1.5 Information Windows

Information windows in the debugger interface contain provide helpful debugging information about the XSLT transformation or XQuery execution. There are eight information windows in XSLT debugging sessions and six in XQuery debugging sessions. These windows are organized, by default, into two groups at the bottom of the debugger interface (*see illustration below*). These windows are described in this section.

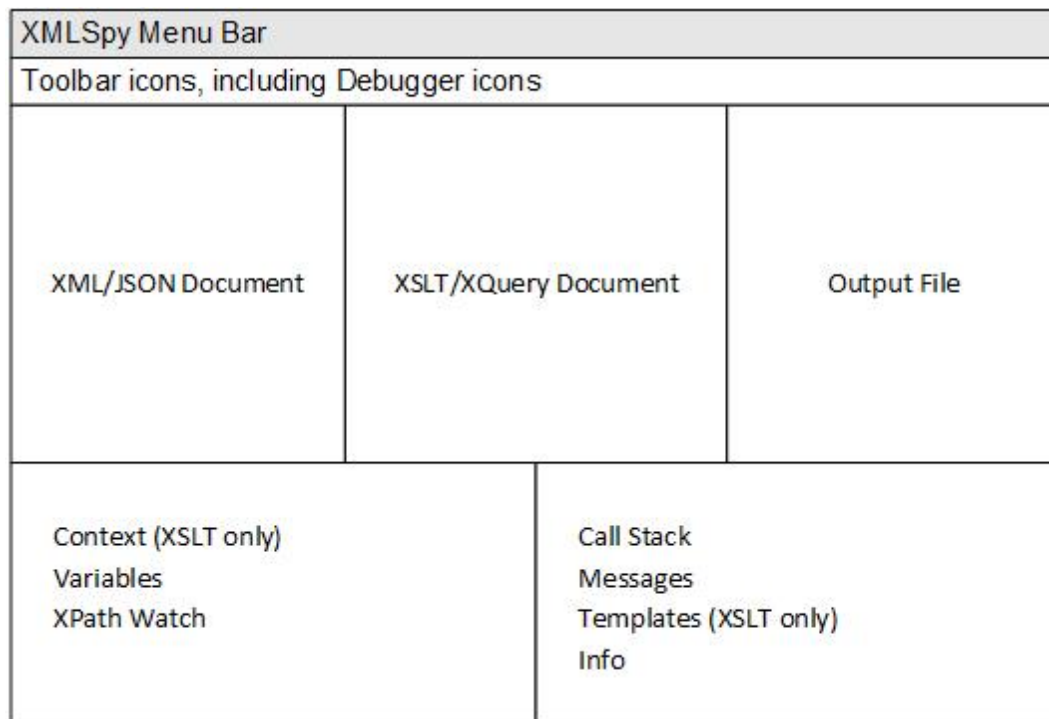

The first group comprises the following information windows:

- [Context](#)⁴¹² (XSLT debugging only)
- [Variables](#)⁴¹³
- [XPath-Watch](#)⁴¹³

The second group comprises the following information windows:

- [Call Stack](#)⁴¹⁴
- [Templates](#)⁴¹⁴ (for XSLT debugging sessions only)
- [Info](#)⁴¹⁵
- [Messages](#)⁴¹⁶
- [Trace](#)⁴¹⁶

In each group, one tab is active at a time. In some tabs, you can use the information display as navigation tools: clicking an item would take you to that item in the XML, XSLT, or XQuery file.

Managing and using information windows

Note the following visibility and locational features:

- The two information-window groups can be resized by dragging their borders.
- Individual windows can be dragged out of the containing group by clicking the tab name and dragging the window out of the group.
- A window can be added to a group by dragging its title bar onto the title bar of the group. Note, however, that there is no reset button to return the layout to the default layout.
- Individual windows can be hidden/shown by toggling their view off/on in the **XSL/XQuery | Debug Windows** submenu.

- To float, dock, or hide a window, select the respective command in the window's context menu (obtained by right-clicking in the window).
- To dock a window in another window group or another location, drag the the window by its title bar or tab and drop it at the desired location on the placement control.

9.1.5.1 Context Window

The Context Window is available for XSLT debugging only (not for XQuery debugging).

When processing an XML document with an XSLT stylesheet, the location reached by the processor at any given time will always be within a certain context node. This context node is shown in the Context Window together with all its descendants. In the screenshot below, the context node at this point is the `office` node.

Name	Type	Value / Attributes
Office	element	
Name	element	Nanonull, Inc.
Desc	element	
Location	element	US
Address	element	
street	element	119 Oakstreet, Suite 4876
city	element	Vereno
state	element	DC
zip	element	29213
Phone	element	+1 (321) 555 5155 0
Fax	element	+1 (321) 555 5155 4
EMail	element	office@nanonull.com
Department	element	
Department	element	
Department	element	
Department	element	
context-position		1
context-size		3

The last two rows of the window indicate that this `office` context node is the first item of a sequence of three items being currently processed. Such a situation could arise, for instance, if an `xsl:for-each` instruction is being processed that selects `office` elements within, say, an `organization` element.

Clicking an entry in the Context Window highlights that item in the XML document. If the XML document is not currently displayed in the interface, a window for the XML document will be opened.

9.1.5.2 Variables Window

The Variables Window displays the in-scope variables and parameters, and their values, at any given time during XSLT/XQuery debugging.

Name	Type	Value
L office		
<> Name	element	
fbc	text	Nanonull, Inc.

Parameters are indicated with **P**, global variables (declared at top-level of a stylesheet) are indicated with **G**, and local variables (declared within an XSLT template) are indicated with **L**. The type of the values of variables and parameters is also indicated.

9.1.5.3 XPath-Watch Window

The XPath-Watch Window enables you to see how an XPath expression would evaluate in one or more contexts. As you step through the XSLT/XQuery document, the XPath expression you entered is evaluated in the current context and the result is displayed in the *Value* column (see screenshot below).

Name	Type	Value
*** //n1:Office/n1:Name	Sequence	
<> Name	element	Nanonull, Inc.
<> Name	element	Nanonull Partners, Inc.
<> Name	element	Nanonull Europe, AG

To enter an XPath expression, double-click in the text field under the Name column and enter the XPath. Alternatively, drag an XPath expression from a file and drop it into the XPath-Watch Window. Use expressions that are correct according to the XPath version that corresponds to the XSLT/XQuery version of the XSLT/XQuery document.

Note: If namespaces have been used in the XML document or XSLT/XQuery document, ensure that the namespace prefixes in your XPath expression correctly target the nodes of the XML document.

9.1.5.4 Call Stack Window

The Call Stack Window displays a list of previously processed XSLT/XQuery templates/instructions, with the current template/instruction appearing at the top of the list. The call stack shows the ancestor templates/instructions of the current template/instruction. If the current template/instruction is a built-in template, then the XSLT document window shows all built-in templates with the current built-in template highlighted.

Call Stack		
Name	Location	Result Document
xsl:value-of	OrgChart.xslt	XSL Output.xml
h1	OrgChart.xslt	XSL Output.xml
xsl:template	OrgChart.xslt	XSL Output.xml
xsl:apply-templates	OrgChart.xslt	XSL Output.xml
body	OrgChart.xslt	XSL Output.xml
html	OrgChart.xslt	XSL Output.xml
xsl:template	OrgChart.xslt	XSL Output.xml
xsl:stylesheet	OrgChart.xslt	XSL Output.xml

Click an item in the window to go to the corresponding XSLT/XQuery template/instruction.

9.1.5.5 Templates Window

The Templates Window is available for XSLT debugging only (not for XQuery debugging).

The Templates Window displays the various templates used in the XSLT stylesheet, including built-in templates and named templates. Matched templates are listed by the nodes they match. Named templates are listed by their name. For both types of template, the mode, priority, and location of the template are displayed.

Templates				
Match	Mode	Name	Priority	Location
		section-summary	-0.5	DebuggerTree.xsl
/			-0.5	DebuggerTree.xsl
OrgChart	DE		0	DebuggerTree.xsl
OrgChart	EN		0	DebuggerTree.xsl
*	#all		-0.5	xslt-2.0
/	#all		-0.5	xslt-2.0
@*	#all		-0.5	xslt-2.0
comment()	#all		-0.5	xslt-2.0
processing-instruction()	#all		-0.5	xslt-2.0
text()	#all		-0.5	xslt-2.0

The Templates Window displays all the templates of the XSLT stylesheet:

- *Named templates* are templates that are identified by a name. In the Templates Window such templates are listed with their names in the *Names* column. In the screenshot above, there is one named template; it has a name of `section-summary`.
- *Matched templates* are those templates that are matched by a test, such as a node-name test or a node-type test. In the screenshot above, there are three matched templates: one that matches the root element and two that match the element named `orgChart`.
- *Built-in templates* are those that, according to the XSLT specifications, must be provided by the XSLT processor. They can be identified by their entries in the *Location* column. In the screenshot above, for example, the `xslt-2.0` entry identifies these templates as the built-in templates of the Altova XSLT 2.0 processor (which is being used because the current XSLT stylesheet is an XSLT 2.0 document).

Note the following points:

- Click an entry in this window, to go to the corresponding template in the XSLT document window.
- If a template's `mode` attribute has been specified, then this value is shown in the *Mode* column of that template. For example, in the screenshot above, we see that there are two templates that match the element named `orgChart`. One of them has a `mode` value set to `DE`, while the other has a `mode` value set to `EN`. (Modes are used to process the same content in different ways. In our example, the `orgChart` content could be processed once with a template for DE output and values and once with a template for EN output.)
- The *Priority* column lists the priority value assigned to a template. If there is more than one template that matches a node, then the XSLT precedence rules for template selection are used to determine which template will be used. If after all the precedence rules are exhausted and there is still more than one template that can be applied, then the template with the highest priority value will be used. While debugging, you can compare priority values in this window to identify problems.

9.1.5.6 Info Window

The Info Window provides meta information about the current debugging session. This information includes what debugger is being used, the names of the source and output documents, and the status of the debugger.

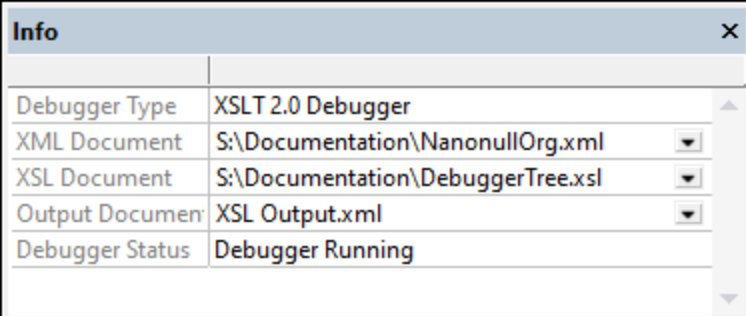

Info	
Debugger Type	XSLT 2.0 Debugger
XML Document	S:\Documentation\NanonullOrg.xml
XSL Document	S:\Documentation\DebuggerTree.xsl
Output Document	XSL Output.xml
Debugger Status	Debugger Running

9.1.5.7 Messages Window

In XSLT debugging, the Messages Window displays error messages, the `xsl:message` instruction, or any error messages that may occur during debugging.

In XQuery debugging, the Messages Window displays error messages.

9.1.5.8 Trace Window

The Trace Window (see *screenshot below*) shows information about the [tracepoints](#) ⁴⁰⁶ that have been set in the relevant documents (XML/JSON and XSLT/XQuery). If you click the **XSL/XQuery | Start Debugger** command, then all tracepoints in the relevant documents are evaluated and are listed in the Trace Window. If, however, you step through the debugging process, then tracepoints are listed as they are encountered.

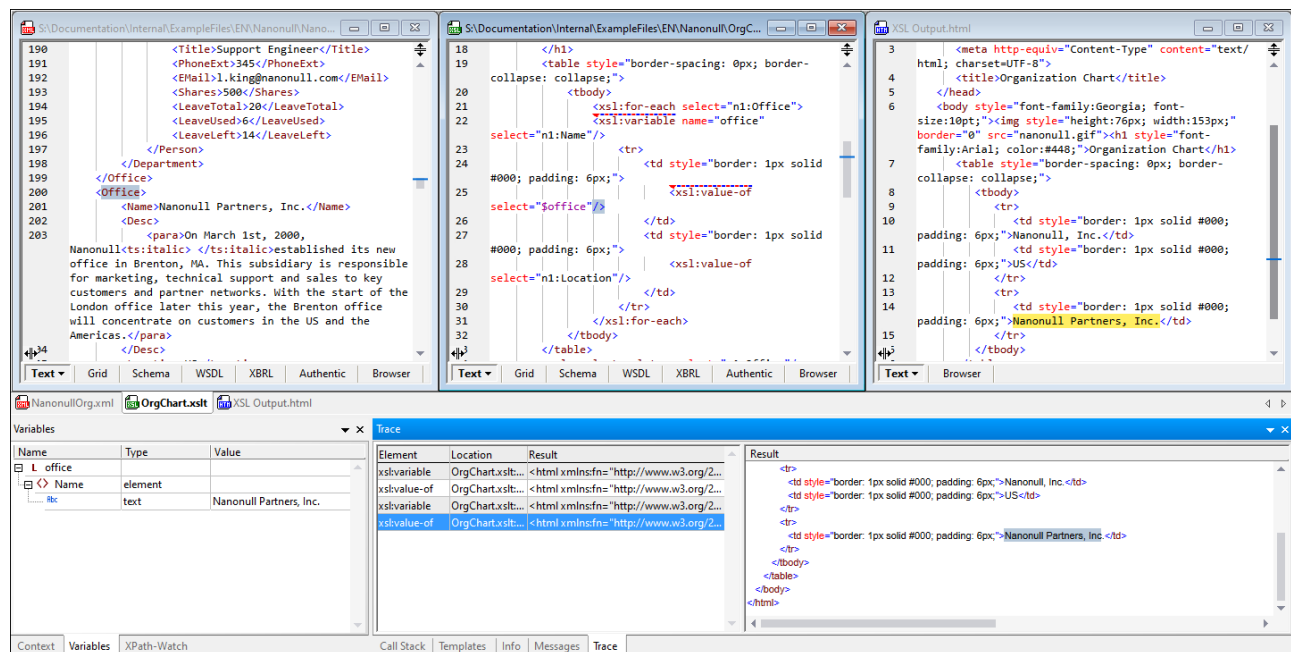

The Trace Window is divided into two panes:

- The main pane on the left has lists the nodes on which the tracepoint has been set, together with the name of the file containing the node and the result returned by the processing/execution at the tracepoint.
- The right pane, which shows the evaluation result of a tracepoint that is selected in the left pane.

For a more detailed discussion, see the topic [Tracepoints](#) ⁴⁰⁶.

9.1.6 Debugger Settings

The Debug Settings dialog enables you to set debugging and output options for all debugging sessions. To access the Settings dialog (*screenshot below*), click **XSL/XQuery | Debug Settings** or click the  icon in the toolbar. The settings of the dialog are described below.

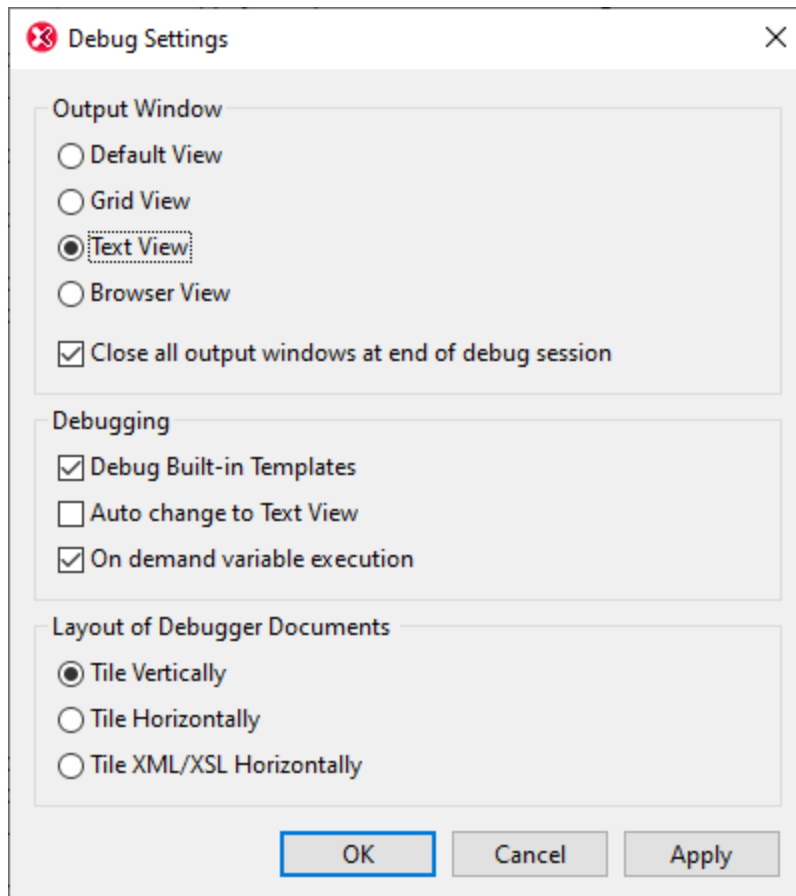

Output Window

Sets the view of the output document window (Default, Text, Grid, or Browser). The Default View is that selected for a file type (identified by its file extension, for example, `.xslt` or `.xq`) in the [File Types section of the Options dialog](#)⁽¹⁰⁴³⁾. For XSLT transformations, the output file type is defined in the XSLT file. For XQuery executions, the output file type is determined by the serialization format you choose in the [XQuery section of the Options dialog](#)⁽¹⁰⁷¹⁾.

The *Close All Output Windows* option gives you the opportunity to keep open the output document windows that were opened in the debugging session when the debugging session ends.

Debugging

The Debug Built-in Templates setting causes the debugger to **step into** built-in templates code whenever appropriate. It is not related to the **display** of built-in templates when clicking this type of template entry in the Templates tab, or if the callstack shows a node from the built-in template file.

The XSLT Debugger works only in Text View or Grid View. The Auto Change to Text View option enables you to automatically switch to the Text View of a document for debugging if a document is not in Text View or Grid View. (The XQuery Debugger works in Text View only.) If the *On demand variable execution* check box is checked, the definition of a variable will be stepped into when the variable is called. Otherwise, the Debugger will not step into the variable definition when it encounters a call to a variable, but will carry on to the next step.

Layout of Debugger Documents

The Debugger documents are those that are open in the Debugger. You can select whether these documents should be tiled vertically, horizontally, or XML/XSLT horizontally with the result document tiled vertically relative to the XML and XSLT.

10 XPath/XQuery Expressions

XPath and XQuery expressions are used to navigate XML trees. With the addition of support for maps and arrays in version 3.1, XPath and XQuery expressions of version 3.1 can also be used to navigate JSON structures. XPath is a subset of XQuery, and any expression that is valid in both languages will return the same result in both languages. For more information about the two languages, see the [XPath 3.1 Recommendation](#) and [XQuery 3.1 Recommendation](#).

Evaluating XPath/XQuery expressions in XMLSpy

XMLSpy provides powerful features to build XPath/XQuery expressions, and to evaluate and debug expressions against XML and JSON documents. This enables you to quickly build and test expressions against the XML or JSON documents on which you plan to use them.

These analytic features are available in the **XPath/XQuery Window**, which is an output window located by default among the other [output windows](#)¹⁰⁷ at the bottom of the application interface. The features of the XPath/XQuery Window are described in the sub-sections of this section.

In a typical user scenario, you would do the following:

1. Open the XML or JSON document for which you want to build or evaluate an expression.
2. Enter the XPath/XQuery expression in the XPath/XQuery Window.
3. Run the Evaluator or Debugger to see the results. The Evaluator shows the end result, whereas the Debugger enables you to go step-by-step through the evaluation process, showing you aspects of the result at each step.

In this section

This section describes the features of the XPath/XQuery Window. It is organized as follows:

- [About the XPath/XQuery Window](#)⁴²⁰
- [Evaluate Mode](#)⁴²²: for evaluating XPath/XQuery expressions
- [Debug Mode](#)⁴²⁸: for debugging XPath/XQuery expressions
- [Expression Builder](#)⁴³⁶: for building XPath/XQuery expressions
- [XQuery Expressions for JSON](#)⁴³⁹
- [Points to Note](#)⁴⁴²

10.1 About the XPath/XQuery Window

The [XPath/XQuery Window](#)¹¹⁵ (screenshot below) enables you to build, evaluate, and debug XPath and XQuery expressions with respect to XML or JSON documents. (Features that enable JSON queries were introduced in XPath/XQuery 3.1. See also [JSON Transformations with XSLT/XQuery](#)⁵⁶⁵.)

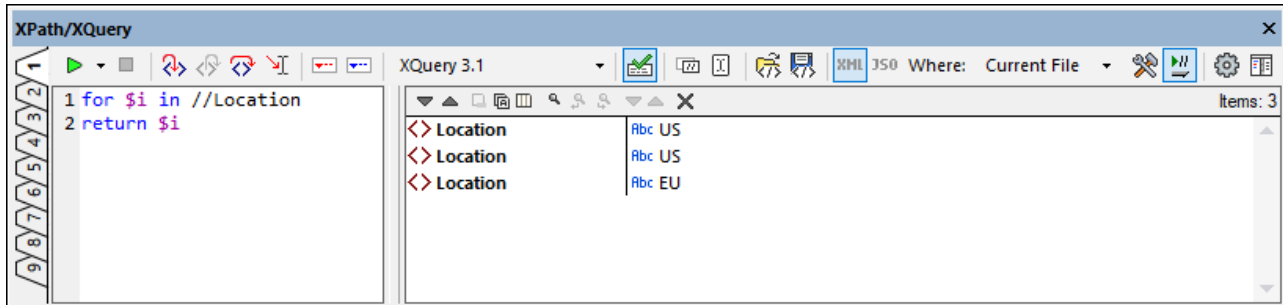

For a broad description of the window and its toolbar, see [XPath/XQuery Window](#)¹¹⁵ in the description of the interface.

Horizontal and vertical layouts

In the right-hand corner of the toolbar is a button (see screenshots above and below) that enables you to switch between a vertical and a horizontal layout. You can switch layouts at any time and in any mode (see [Evaluation Mode and Debug Mode](#)⁴²¹ below). The screenshot above shows the vertical layout, which is useful when the XPath/XQuery expression (in the left-hand pane in the screenshot above) spans multiple lines.

The horizontal layout (screenshot below) is useful in cases where the result has lines that have a large horizontal extent..

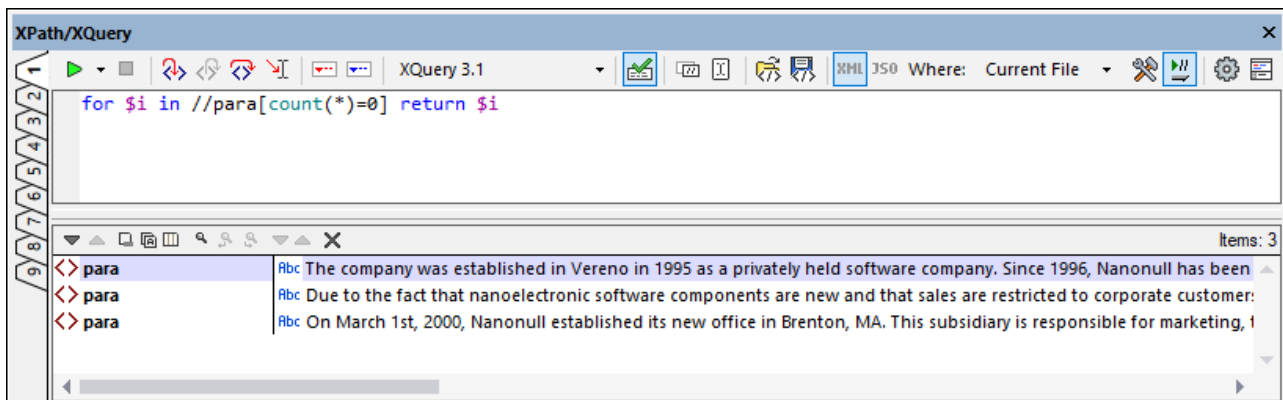

Nine tabs

The XPath/XQuery Window has nine tabs, which are located at the left of the window (see screenshots above). Having multiple tabs enables you to work with different expressions in different tabs and compare results. Click the handle of the tab you want to switch to.

Evaluation Mode and Debug Mode

The [XPath/XQuery Window](#)¹¹⁵ can be used in two modes:

- [Evaluation Mode](#)⁴²², in which an XPath or XQuery expression is evaluated with respect to one or more XML/JSON documents. The expression is entered in the **Expression pane**, and the result is displayed in the adjoining **Results pane**. You can click nodes in the result to go to that node in the XML or JSON document.
- [Debug Mode](#)⁴²⁸, in which you can debug an XPath/XQuery expression as it applies to the currently active XML document. You can set breakpoints and tracepoints, and go step-by-step through the evaluation. At each step you can see the content of variables, as well as set custom Watch expressions to check additional aspects of the evaluation.

To switch between the two modes, select the appropriate command in the **Start Evaluation/Debugging** dropdown menu that is located in the left-hand corner of the window's toolbar (see *screenshot below*).

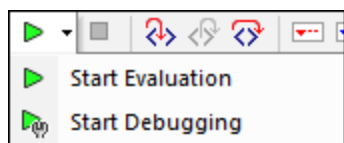

How to use the two modes is described in the sub-sections of this section.

XPath/XQuery Expression Builder

In [both modes](#)⁴²¹, the [Expression Builder](#)⁴³⁶ can be used to help you construct syntactically correct expressions. Switch [Expression Builder](#)⁴³⁶ on/off with the **Builder Mode** button of the main toolbar .

10.2 Evaluating the Expression

The XPath/XQuery Window enables you to build an XPath or XQuery expression (in a language version that you can select; see *screenshot below*), and then evaluate the expression within a scope that you specify in the *Where* option (see *screenshot*). The expression can be evaluated on the current file, as well as on the following sets of multiple files: (i) all currently open documents; (ii) files of the currently active [XMLSpy project](#)⁷¹⁴; or (iii) files of a selected folder. To simply test the expression, one suitable file as the scope would be appropriate. The XPath/XQuery Window can, however, also be used to find specific data in one or more files and report these in the Results pane; in this case, select an appropriate file-set in the scope.

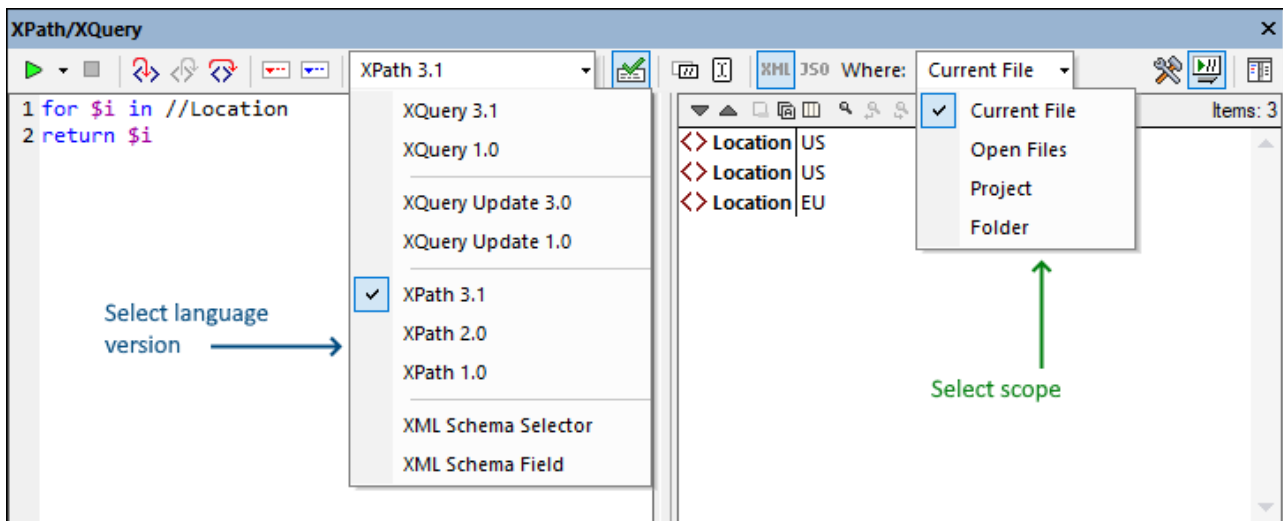

The XPath/XQuery Window comprises a toolbar and two panes—the Expression pane (*at left in the screenshot above*) and the Results pane (*at right in the screenshot*).

Evaluation procedure

To evaluate an XPath/XQuery expression, do the following (*refer also to the screenshot above*):

1. *Select Evaluation Mode*: Select **Start Evaluation** in the dropdown menu of the **Start Evaluation/Debugging (F5)** command (located at top left of the toolbar; see *screenshot below*).

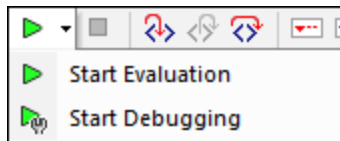

2. *Horizontal/Vertical layout*: To switch layout, click the **Horizontal/Vertical Layout** button (located at the top right of the toolbar). Default is vertical layout.
3. *Select language version*: In the toolbar, select the language version for the expression you want to evaluate; for example, XPath 3.1. Default is XPath 3.1. Also see the note below titled [XML Schema Selector and XML Schema Field](#)⁴²⁴.
4. *Enter expression*: In the Expression pane, enter the expression to evaluate. For help with constructing an expression, use the entry helpers of the [Expression Builder](#)⁴³⁶. For more information about editing features of the Expression pane, also see the note below titled [Editing in the Expression pane](#)⁴²⁴.

5. *Select evaluation scope:* In the toolbar's *Where* option, select the file/s on which the expression is to be evaluated. The options are: *Current file*; *Open files*; *(XMLSpy) Project*; or *Folder*. Default is *Current File*.

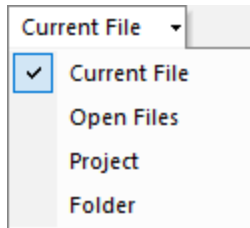

If *Current file* is selected, the file that is currently active is queried. Selecting *Open files* causes the expression to be evaluated against all the files currently open in XMLSpy. *Project* refers to the currently active [XMLSpy project](#)⁷¹⁴. (The external folders in an XMLSpy project can be excluded by checking the *Skip external folders* icon.) The *Folder* option enables you to browse for the required folder; the XPath expression will be evaluated against XML or JSON files in this folder.



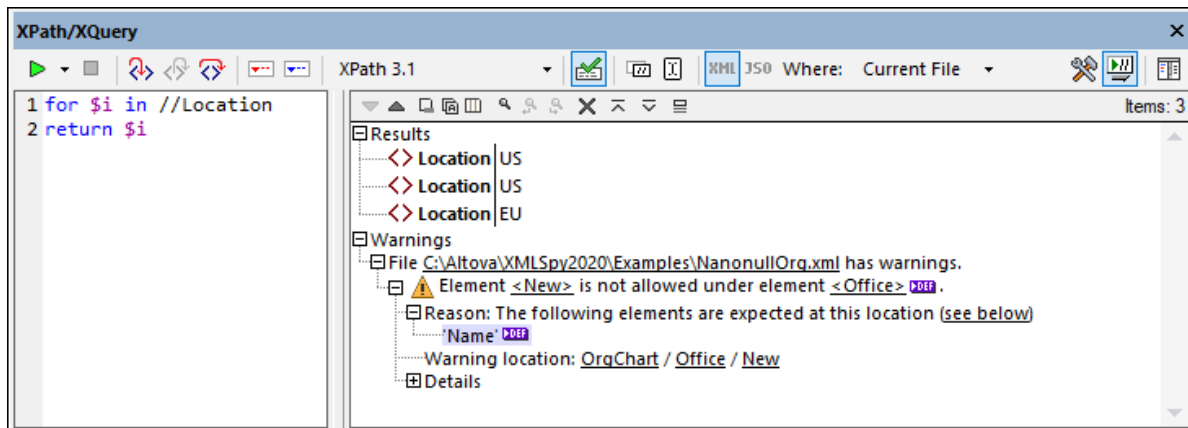







6. *Select XML or JSON evaluation:* If the evaluation scope is the current file, the evaluation mode (XML or JSON) is automatically determined by the [conformance type of the document's file type](#)¹⁰⁴³ (JSON mode for JSON-conformant files, XML mode for non-JSON files). This auto-detected mode cannot be changed, and the buttons are disabled. If the evaluation scope is a multiple-file option, then both buttons are enabled and you can select the evaluation mode you want; the default is whichever of the two options was previously selected.
7. *Set the context node:* The context node can be set to either: (i) the root node, or (ii) the current selection in the active document. You can toggle between the two settings via the toolbar button **Set current selection as origin for XPath/XQuery**. The default setting is the root node.
8. *XML validation:* If the **Validate XML** toolbar button is toggled on (the default setting), then the XML files being evaluated will be validated. Errors are treated as warnings and are reported in the Results pane (*screenshot below*), but evaluation continues.



9. *Evaluate the expression:* If the toolbar's toggle option **Evaluate on typing** is selected, then the result of the evaluation is displayed in the Results pane as you type the expression. If this option is not selected, then the evaluation must be explicitly started, by clicking the command **Start Evaluation/Debugging (F5)** (located at top left of the toolbar).

☐ *Toolbar buttons used in the evaluation procedure*

	Start	Enables selection of Evaluation Mode, and starts the evaluation
--	--------------	---

	Evaluation/Debugging (F5)	
	Stop Evaluation/Debugging (Shift+F5)	Enabled during evaluation. It is useful if the evaluation takes very long or goes into an endless loop, and you therefore want to stop the evaluation
	Validate XML	When toggled on, the target XML document/s are validated
	Copy XPath of Current Selection	Copies the locator path of the node in the XML document to the last cursor position in the Expression pane
	Set current selection as context	Toggles expression context between root node and the current selection
	Load Snippet	Loads an XPath/XQuery snippet from an XQuery file to the evaluator pane, overwriting the current contents of the pane
	Save Snippet	Saves an XPath/XQuery snippet from the evaluator pane to an XQuery file
	XML/JSON Evaluation Mode (toggles between XML and JSON evaluation modes)	The highlighted icon of the pair is the active option. When evaluation scope is multiple files, both icons are enabled and one can be selected. Otherwise, evaluation mode is auto-detected according to file type; the other icon is disabled.
	Switch to Builder	Switches to Expression Builder mode, which provides context-sensitive entry helpers to help construct expressions
	Evaluation on typing	Switches on the evaluation of expressions while the expression is being typed
	Show Options	Opens an Options dialog for setting the display options of results
	Horizontal/Vertical Layout	Switches between horizontal and vertical layouts

XML Schema Selector and XML Schema Field

The *XML Schema Selector* and *XML Schema Field* options are used for a narrow subset of specific XPath 1.0 cases and are useful when unique identity constraints have been defined in the XML Schema. When either of these options is selected, only name tests (and the wildcard *) are allowed in the XPath expression, and predicates and XPath functions may not be used. Furthermore, for the *XML Schema Selector* option, only expressions on the child axis are allowed; for the *XML Schema Field* option, expressions on the child axis and attribute axis are allowed. For more information, see the W3C's [XML Schema: Structures Recommendation](#).

Editing in the Expression pane

Note the following points about editing expressions in the Expression pane:

- To create the expression over multiple lines (for easier readability), use the **Return** key.
- To increase/decrease the size of text in the expression field, click in the expression field, then press **Ctrl** and turn the scroll wheel. *Note that this also applies in the Results pane.*
- Instead of manually entering the locator path expression of a node, you can let XMLSpy enter it for you. Do this as follows: (i) Place the cursor at the point in the XPath expression where you want to

enter the locator path; (ii) Place the cursor inside the node you want to target; (iii) In the toolbar, click the button **Copy the XPath of the Current Selection**. This enters the locator path of the selected node in the expression. The locator path will be an absolute path starting at the root node of the document.

XQuery and JSON evaluations

- For information about XQuery evaluations, see the section, [XQuery Evaluation](#)³⁸³. (The **xq** icons are for [XQuery evaluation](#)³⁸³; the **xqu** icons are for [XQuery Update executions](#)³⁸⁷.)
- For a description of querying JSON documents, see [XQuery Expressions for JSON](#)⁴³⁹ and [JSON Transformations with XSLT/XQuery](#)⁵⁶⁵.

Results pane

The Results pane is shown in the screenshot below, at right. Note that it has its own toolbar.

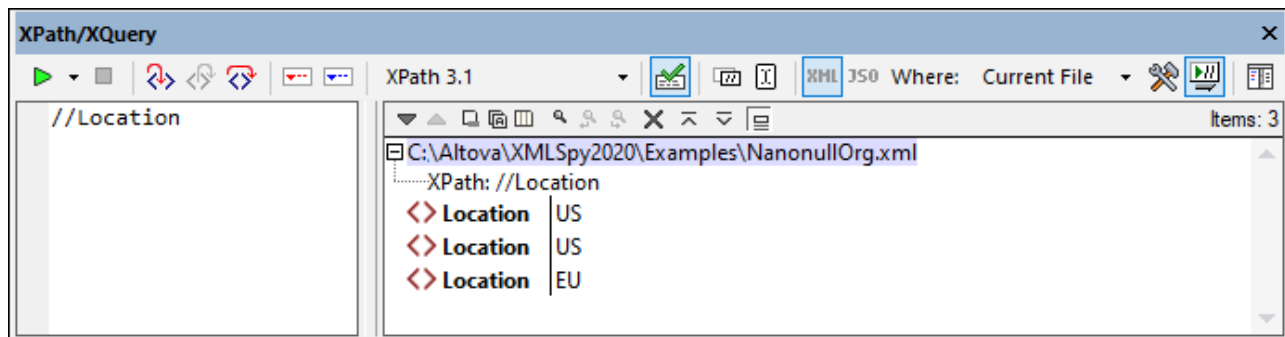

The Results pane has the following functionality:

- Toggle on the *Show Header in Output* icon if, in the output, you wish to show the location of the XML file and the XPath expression (as in the screenshot below).
- The result list consists of two columns: (i) a node name or a datatype; (ii) the content of the node.
- If the XPath expression returns nodes (such as elements or attributes), you can select whether the entire contents of the nodes should be shown as the value of the node. To do this, switch on the toggle *Show Complete Result*.
- When the result contains a node (including a text node)—as opposed to expression-generated literals—clicking that node in the Results pane highlights the corresponding node in the XML document in the Main Window.
- If the evaluation is carried out on multiple files (specified in the *Where* option), then the results of each file are listed separately under the path of that file (see screenshot below). If the evaluation mode is XML, then XML-conformant files are evaluated, other types are skipped. If the evaluation mode is JSON, then JSON-conformant files are evaluated, other types are skipped.

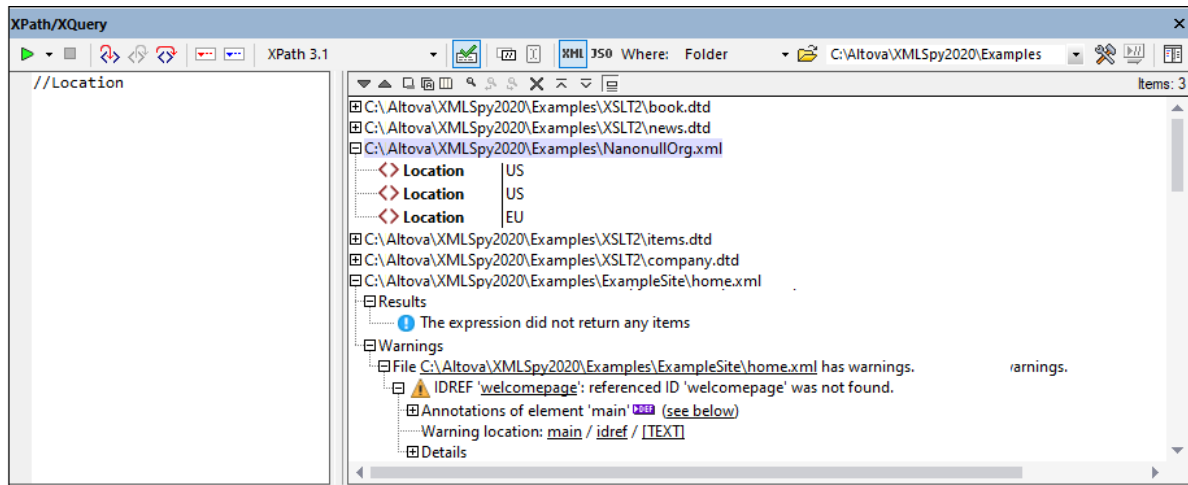

- If the results involve multiple files, clicking a filename in the results list opens the file in XMLSpy and makes it the active file.
- You can copy both columns of a result sub-line, or only the value column. To copy all columns, right-click a sub-line and toggle on **Copying Includes All Columns**. (Alternatively you can toggle the command on/off via its icon in the toolbar of the Results pane.) Then right-click the sub-line you want to copy and select either **Copy Subline** (for that subline) or **Copy All** (for all sublines).

Toolbar of the Results pane

The toolbar of the Results pane contains icons that provide navigation, search, and copy functionality. These icons, starting from the left, are described in the table below. The corresponding commands are also available in the context menu of result list items.

Icon	What it does
<i>Next, Previous</i>	Selects, respectively, the next and previous item in the result list
<i>Copy the selected text line to the clipboard</i>	Copies the value column of the selected result item to the clipboard. To copy all columns, toggle on the <i>Copying includes all columns</i> command (see below)
<i>Copy all messages to the clipboard</i>	Copies the value column of all result items to the clipboard, including empty values. Each item is copied as a separate line
<i>Copying includes all columns</i>	Switches between copying (i) all columns, or (ii) only the value column. The column separator is a single space
<i>Find</i>	Opens a <i>Find</i> dialog to search for any string, including special characters, in the result list
<i>Find previous</i>	Finds the previous occurrence of the term that was last entered in the <i>Find</i> dialog
<i>Find next</i>	Finds the next occurrence of the term that was last entered in the <i>Find</i> dialog
<i>Expand with children</i>	Expands the selected item and all its descendants
<i>Collapse with children</i>	Collapses the selected item and all its descendants
<i>Clear</i>	Clears the result list

Display options

When you click the **Show Options** button (gear icon) at the top right of the XPath/XQuery a dialog appears in which you can specify display options of the Result pane. You can choose to display results as an expandable tree structure or as a serialized XML string (a node is shown as a text string, just as it is written in an XML document). Additionally you can choose to show attributes inline, which means that attributes and their values are shown on the same line as the element (additional to being shown in the tree structure of the node).

10.3 Debugging the Expression

The Debug Mode of the XPath/XQuery Window (*screenshot below*) enables you to debug an XPath/XQuery expression as it applies to the active file.

In Debug Mode, two additional panes are added to the Results pane (*see screenshot below*):

- the Watch Expressions and Variables pane; both watch expressions and variables are shown together in the same pane, with variables being able to be toggled on/off
- the Call Stack and Debug Points pane, each of which has a separate tab in the pane

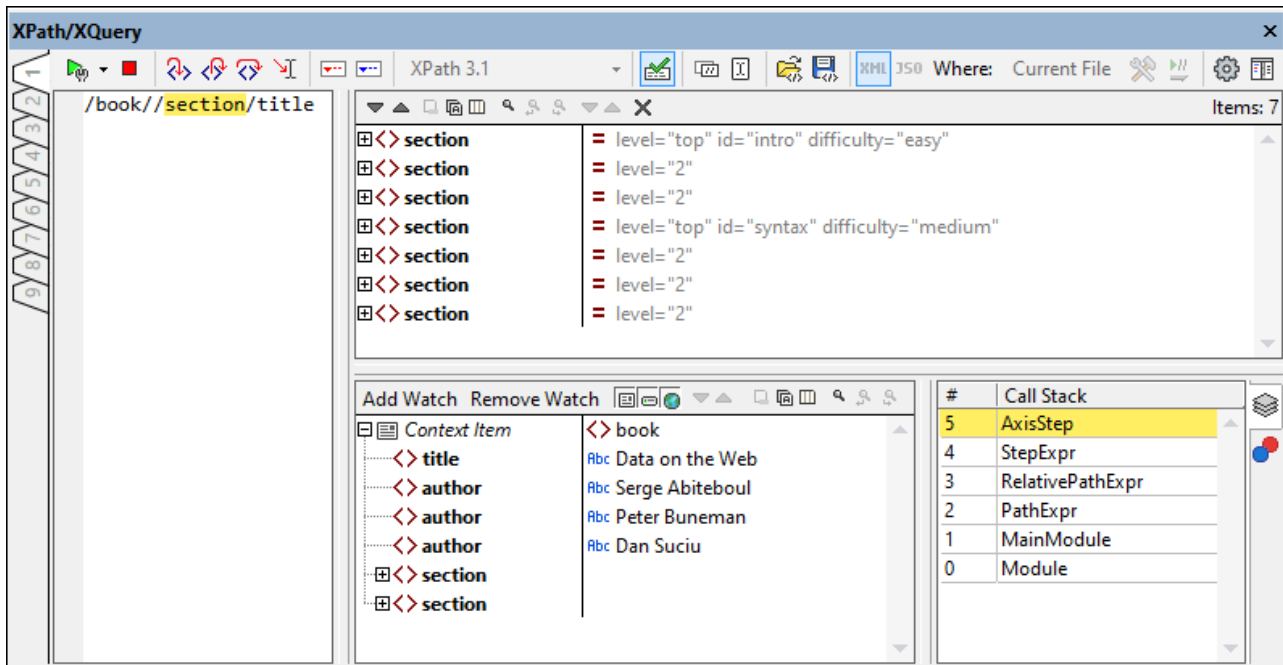

The Expression and Result panes can adjoin each other horizontally or vertically. To switch between these layouts, click the **Horizontal/Vertical Layout** button (at top right of the window's toolbar).

Debugger Mode offers the following features:

- Enables you to step into the XPath evaluation process, one step at a time to see how the XPath expression is being evaluated. Use the **Step Into (F11)** toolbar button for this. At each evaluation step, the part of the expression being currently evaluated is highlighted in yellow (*see screenshot above*), while the result of evaluating that step is shown in the Results pane. For example, in the screenshot above, all the `section` descendant elements of the `book` element have been selected, whether they occur as child elements of `book` or are nested further below.
- The Watch Expressions and Variables pane always shows the context node of the expression step that is being currently evaluated. So, in the screenshot above, for example, the expression step being currently evaluated is `//section`. Its context node is `book`. So the `book` node (and its content) is displayed as the context item.
- Set breakpoints where you want to pause the evaluation and check results at these points. You can then step through the evaluation by pausing only at breakpoints. Use the **Start Debugging (F5)** toolbar button for this. This is quicker than pausing at every step with **Step Into (F11)**.

- Set tracepoints to see a report of results at the steps marked as tracepoints. The evaluation will not pause (except at breakpoints), but all the tracepoint results will be displayed together in a list in the Results pane.
- Watch expressions can be used to check information (such as document content or aspects of the evaluation) as the evaluation progresses. Of great use is the display of the context item in the same window. This enables you to assess how the result of the watch expression relates to the context item. You can enter multiple watch expressions, which is useful to compare results of different expressions within the same context item.
- Variables that are in scope, including their values, are displayed in the Watch Expressions and Variables pane. You can toggle on/off global and variables separately. It can be very useful to see the values of variables within a context item together with the result of watch expressions.
- Processor calls of an evaluation step are shown in the Call Stack tab of the Call Stack and Debug Points pane.
- If breakpoints and tracepoints have been set, then these are displayed in the Debug Points tab of the Call Stack and Debug Points pane.

For more information about these features, see their descriptions below.





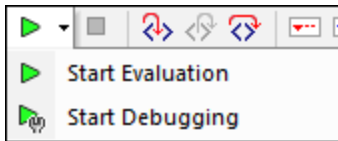

Setting up Debug Mode







To switch to Debug Mode, click **Start Debugging** in the dropdown menu of the **Start Evaluation/Debugging (F5)** command (located at top left of the toolbar; *see screenshot below*). When in Debug Mode, the Watch Expressions pane and Call Stack and Debug Points pane will appear. To start debugging the current expression, click **Start Debugging** or **F5**.



Note that Debug Mode works only with the current file; it cannot be used with multiple files. As a result, the *Where* option will automatically be set to *Current File* when you switch to this mode and cannot be changed.

Buttons for setting up Debug Mode

	Start Evaluation/Debugging (F5)	Enables selection of Evaluation Mode, and starts the evaluation
	Stop Evaluation/Debugging (Shift+F5)	Enabled during evaluation. It is useful if the evaluation takes very long or goes into an endless loop, and you therefore want to stop the evaluation
	Validate XML	When toggled on, the target XML document/s are validated
	Copy XPath of Current Selection	Copies the locator path of the node in the XML document to the last cursor position in the Expression pane
	Set current selection as context	Toggles expression context between root node and the current selection
	Load Snippet	Loads an XPath/XQuery snippet from an XQuery file to the evaluator pane, overwriting the current contents of the pane





	Save Snippet	Saves an XPath/XQuery snippet from the evaluator pane to an XQuery file
	XML/JSON Evaluation Mode (toggles between XML and JSON evaluation modes)	The highlighted icon of the pair is the active option. When evaluation scope is multiple files, both icons are enabled and one can be selected. Otherwise, evaluation mode is auto-detected according to file type; the other icon is disabled.
	Switch to Builder	Switches to Expression Builder mode, which provides context-sensitive entry helpers to help construct expressions
	Evaluation on typing	Switches on the evaluation of expressions while the expression is being typed
	Show Options	Opens an Options dialog for setting the display options of results
	Horizontal/Vertical Layout	Switches between horizontal and vertical layouts



Running the Debugger

The broad steps for debugging an XPath/XQuery expression are, typically, as follows:

1. Make the XML/JSON file on which you wish to run the expression the active file.
2. Select the XPath/XQuery(Update) version of the expression you want to debug.
3. Enter the XPath/XQuery expression in the expression pane.
4. Set any breakpoints or tracepoints you want. A breakpoint is a point at which the evaluation is paused. A tracepoint is a point in the evaluation that is recorded; tracepoints thus provide a traceable path of evaluation results.
5. If you click **Start Debugger**, evaluation is carried out in one step to the end unless a breakpoint has been marked in the expression. Click **Start Debugger** repeatedly to progress through each breakpoint to the end of the evaluation.
6. Use the Step Into/Out/Over functionality to go step-by-step through the evaluation. You can also use the Run to Cursor functionality to go directly to the expression step where you place the cursor

Buttons for debugging

	Start Debugger (F5)	Starts the debugger. Evaluation goes directly to the end, stopping only for breakpoints
	Stop Debugger (Shift+F5)	Exits the evaluation and stops the debugger
	Step Into (F11)	Proceeds through the evaluation, one step at a time.
	Step Out (Shift+F11)	Steps out of the current evaluation step, and goes to the parent step
	Step Over (Ctrl+F11)	Steps over descendant steps

	Run to Cursor (Ctrl+F5)	Evaluates directly to the expression step where the cursor is. A second click evaluates to the end of the expression.
	Insert/Remove Breakpoint (F9)	Inserts/removes a breakpoint at the expression step where you place the cursor
	Insert/Remove Tracepoint (Shift+F9)	Inserts/removes a tracepoint at the expression step where you place the cursor

Stepping in, out, and over evaluation steps

The *Step Into* functionality enables you to go step-by-step through the evaluation. Each click of this command takes you through the next step of the evaluation; the current step is shown by the highlighting in the expression (see screenshot below). The *Step Out* functionality takes you to a step on a higher level as the current step, whereas the *Step Over* functionality steps over lower-level steps and takes you to the next step on the same level. You can try out the *Stepping* functionality by pasting the XQuery 3.1 expression given below into the Expression pane and clicking the three *Step* buttons to see how they work.

▣ XQuery 3.1 expression for trying the Step Into, Step Out, and Step Over functionality

```

declare function local:plus($a, $b) {
    $a + $b
};

declare function local:loop() {
    for $i in 1 to 10
    return (local:plus($i, $i+1), local:plus($i+1, $i+2))
};

local:loop()

```

The screenshot below shows the evaluation when processing has been paused on reaching the addition step **\$a + \$b** during the first pass through the loop—that is, when $i=1$. At this addition step, the result shows **3** (as a consequence of $1+2$).

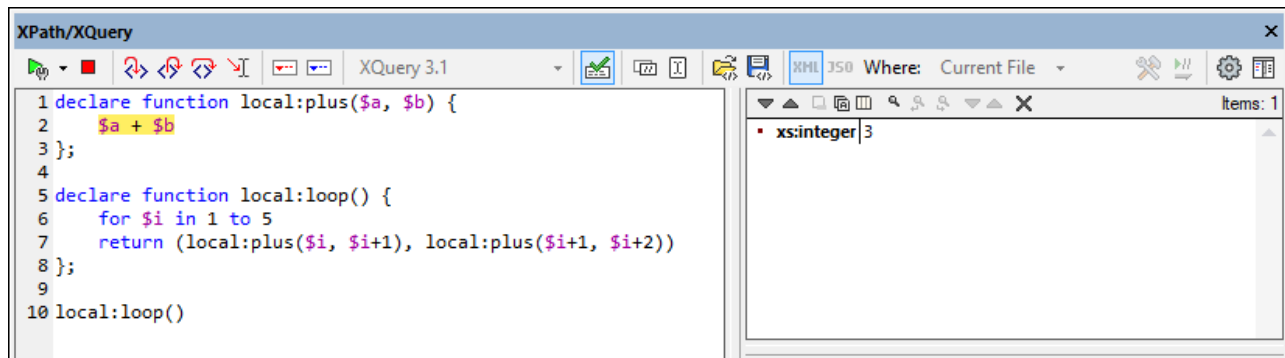

Breakpoints

Breakpoints are points where you want the Debugger to stop after it has been started with **Start Debugger**. They are useful if you wish to analyze a specific part of the expression. When the Debugger stops at the

breakpoint, you can check the result and could then use the **Step Into** functionality to display the results of the next steps of the evaluation. To set a breakpoint, place the cursor in the expression at the point where you want the breakpoint, and click the **Insert/Remove Breakpoint (F9)** toolbar button. The breakpoint will be marked with a dashed red overline. To remove a breakpoint, select it and click **Insert/Remove Breakpoint (F9)**.

Also see [Debug Points](#) ⁴³⁴ below.

Tracepoints

Tracepoints are points at which the results are recorded. These results are displayed in the *Traces* tree of the *Result* tab (see *screenshot below*). This enables you to see all the evaluation results of particular parts of the expression. For example, in the screenshot below, tracepoints have been set on `$a`, `$b`, and `local:plus($i, $i+1)`; the results at these tracepoints during the first iteration through the loop are shown in the *Traces* tree: `$a=1`, `$b=2`, and `local:plus($i, $i+1)=3`.

To set a tracepoint, place the cursor at the point where you want the tracepoint, and click the toolbar button **Insert/Remove Tracepoint (Shift+F9)**. The tracepoint will be marked with a dashed blue overline (see *screenshot below*). To remove a tracepoint, select it and click **Insert/Remove Tracepoint (F9)**.

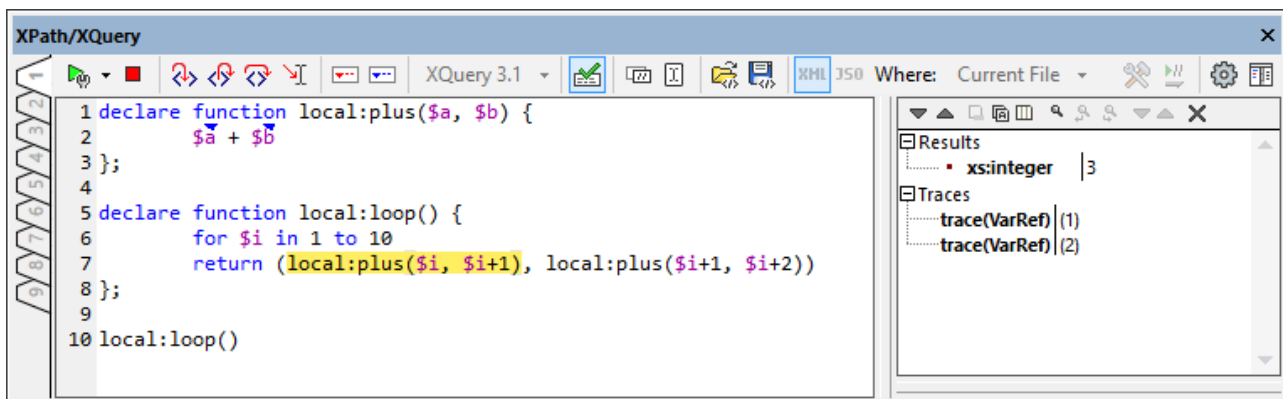

Note: If both a breakpoint and a tracepoint are set on a part of the expression, then the overline is composed of alternating red and blue dashes.

Also see [Debug Points](#) ⁴³⁴ below.

Watch Expressions and Variables

Watch expressions and variables are displayed in the Watch Expressions and Variables pane (*bottom center pane in the screenshot below*).

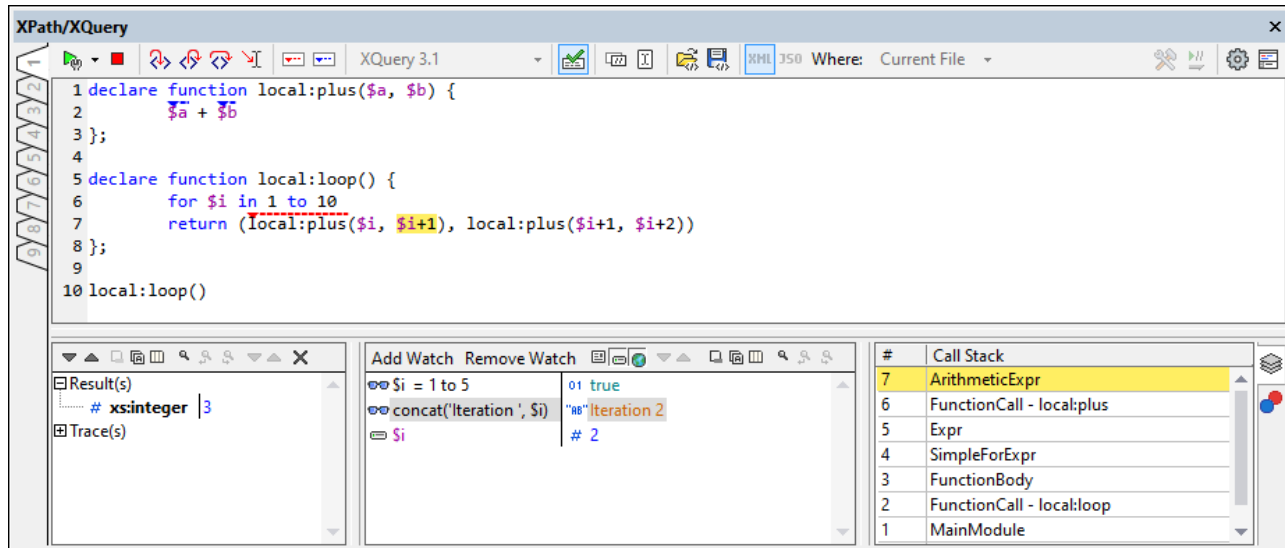

Watch expressions

Watch expressions are expressions that you can enter, either before evaluation starts or during a pause in evaluation. They can be used for the following purposes:

- To test specific conditions. For example in the screenshot above, the watch expression `$i=1 to 5` is used to test whether the `$i` variable has a value in the given range at any given time during processing. The result `true` tells us that this condition has been met in the current processing context.
- To find data within a certain context. For example, within the context of a `company` element, we could enter a watch expression `@id` to look up that company's customer code in the target XML document.
- To generate additional data. For example in the screenshot above, the watch expression `if ($i=1 to 5) then (concat("Iteration ", $i)) else "Out of Loop"` can generate a suitable string to indicate in which iteration of the loop the evaluation currently is.

To enter a watch expression, click **Add Watch** in the pane's toolbar, then enter the expression and click **Enter** when done. To remove a watch expression, select it and click **Remove Watch** in the toolbar. If, during debugging, the expression cannot be correctly evaluated for some reason (for example, if one of its variables is out of scope), then the watch expression turns red.

Variables

Variables that have been declared in the expression and that are in scope in the current evaluation step will be displayed together with their respective current values. For example, in the screenshot above, processing has just reached the call to the `local:plus` function. The `$i` variable is in scope within the `local:loop` function and has just been incremented to 2. So `$i` is displayed with its current value. You can toggle on/off the display of local and global variables by clicking their respective toolbar icons.

Icons of the pane

Note the availability of the following features via the icons of the pane.

Icon	What it does
<i>Next, Previous</i>	Selects, respectively, the next and previous item in the result list
<i>Copy the selected text</i>	Copies the value column of the selected result item to the clipboard. To copy all

<i>line to the clipboard</i>	columns, toggle on the <i>Copying includes all columns</i> command (see below)
<i>Copy all messages to the clipboard</i>	Copies the value column of all result items to the clipboard, including empty values. Each item is copied as a separate line
<i>Copying includes all columns</i>	Switches between copying (i) all columns, or (ii) only the value column. The column separator is a single space
<i>Find</i>	Opens a <i>Find</i> dialog to search for any string, including special characters, in the result list
<i>Find previous</i>	Finds the previous occurrence of the term that was last entered in the <i>Find</i> dialog
<i>Find next</i>	Finds the next occurrence of the term that was last entered in the <i>Find</i> dialog
<i>Expand with children</i>	Expands the selected item and all its descendants
<i>Collapse with children</i>	Collapses the selected item and all its descendants
<i>Clear</i>	Clears the result list

Call stack

The *Call Stack* tab of the Call Stack and Debug Points pane (*bottom right pane in the screenshot above*) displays the processor calls up to that point in the debugging. The current processor call is highlighted in yellow. Note that only the calls that directly led to the current evaluation step are displayed. For example, in the screenshot above, the current evaluation step is an arithmetic calculation expression within a function call to the `local:plus` function. Now, although this is the second iteration of `local:loop`, the processor calls of the first iteration are **not** displayed. This is because those calls are on a parallel level to the current function call and did not lead to it.

Debug points

The Debug Points tab of the Call Stack and Debug Points pane (*bottom right pane in the screenshot below*) shows the breakpoints (with red circles) and tracepoints (blue circles) that you have set on the expression. Each debug point (breakpoint or tracepoint) is listed with its line and character number. For example, `FunctionCall@7:17` means that there is a debug point on line 7, character 17.

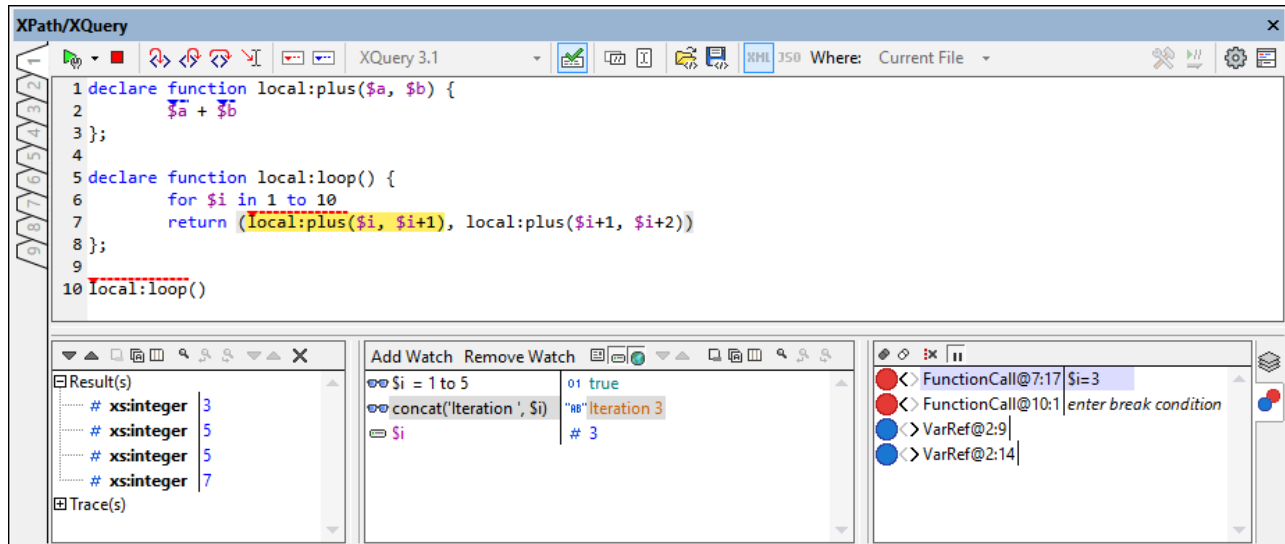

Note the following features:

- For breakpoints, you can enter a **break condition** by double-clicking *Enter break condition*, entering the expression for the condition, and pressing **Enter**. That breakpoint will be enabled only when the break condition evaluates to `true`. For example, in the screenshot above, the break condition `$i=3` will enable the breakpoint on this function-call only when the value of `$i` is 3. The screenshot shows the evaluation paused at this breakpoint.
- You can enable/disable all debug points by clicking their respective toolbar buttons: **Enable All Debug Points** and **Disable All Debug Points**. When a debug point is disabled, it is deactivated for all evaluations till it is enabled again.
- You can also enable/disable breaks in processing when a processing error is encountered by toggling on/off the corresponding toolbar icon.
- You can enable/disable individual breakpoints in their respective context menus and by clicking their circle icons. When a circle icon is gray, the debug point has been disabled.

Display options

When you click the **Show Options** button (gear icon) at the top right of the XPath/XQuery a dialog appears in which you can specify display options of the Result pane and the Watch Expressions and Variables panes. You can choose to display, for each pane separately:

- results as an expandable tree structure or as a serialized XML string (a node is shown as a text string, just as it is written in an XML document), and
- attributes inline, which means that attributes and their values are shown on the same line as the element (additional to being shown in the tree structure of the node).

10.4 Expression Builder

The Expression Builder (or Builder Mode) is switched on/off by clicking the **Builder Mode** icon of the main toolbar . (see *screenshot below*). The Expression Builder can be switched on in both modes ([Evaluation Mode](#) and [Debugging Mode](#)⁴²⁰). It has two entry-helper panes: (i) for operators and expressions; and (ii) for functions (see *screenshot below*). The items in both panes can be shown either grouped hierarchically or as a flat list. Select the option you want in the dropdown list at the top right of each pane (see *screenshot below*). In the screenshot, both panes show their items in hierarchical groups.

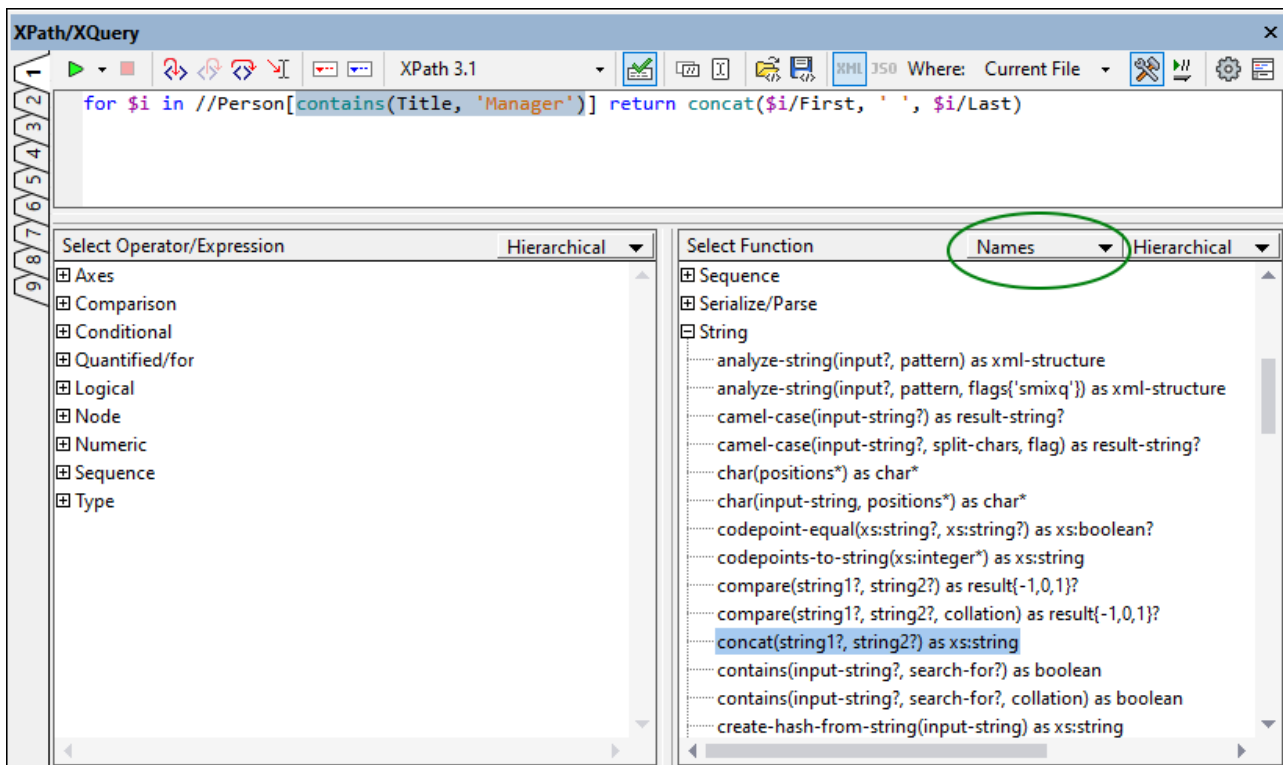





Features of the Expression Builder:

- To view a text description of an item in either entry-helper pane, hover over the item.
- Each function is listed with its signature (that is, with its arguments, the datatypes of the arguments, and the datatype of the function's output).
- If more than one signature exists for a single function name, each signature is listed as a separate function. (These variants are known as **overloads** of that function name.) In the screenshot above, for example, the `contains` function is shown twice: once for each of its two signatures.
- Arguments are listed by their names (if any) or by their datatypes. Select the option you want from the dropdown list in the title bar of the Functions pane (*circled in green in the screenshot above*).
- Double-clicking an item in any of the panes (operator, expression, or function), inserts that item at the cursor location in the expression. Functions are inserted with their arguments indicated by placeholders (`#` symbols).
- If (i) text is selected in the expression's edit field, and (ii) an operator, expression or function that contains a placeholder is double-clicked to insert it, then the text that was selected is inserted instead

of the placeholder. This is a quick way to insert long text (such as a path expression) into an operator, expression, or function.

- You can insert the path to a node in the active document by selecting that node and then clicking the button **Copy the XPath of the current selection** of the window's main toolbar.

Toolbar buttons used in Expression Builder

	Horizontal/Vertical Layout	Switches between horizontal and vertical layouts
	Switch to Builder	Switches to Expression Builder mode, which provides context-sensitive entry helpers to help construct expressions
	Copy XPath of Current Selection	Copies the locator path of the node in the XML document to the last cursor position in the Expression pane
	Set current selection as context	Toggles expression context between root node and the current selection
	Load/Save XPath/XQuery snippet	Respectively, loads/saves an XPath/XQuery snippet from/to an XQuery file

After you have entered a function in the expression, hovering over the function name in the Expression pane displays the function's signature and a text description of the function. If more than one signature exists for a function, these are indicated with an overload factor at the bottom of the display. If you place the cursor within the parentheses of the function and press **Ctrl+Shift+Spacebar**, you can view the signatures of the various overloads of that function name (see screenshot below).

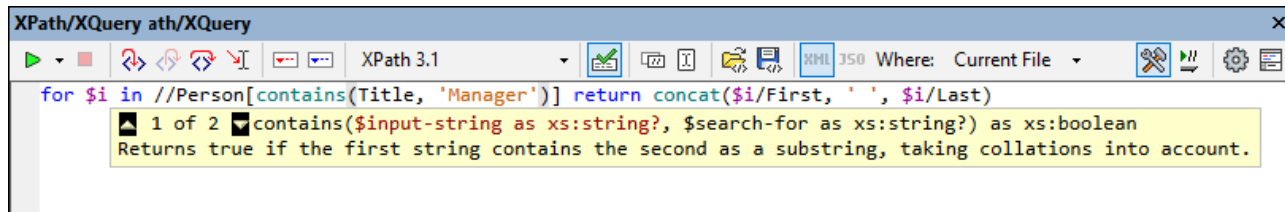

Open and save XPath/XQuery snippets from/to file

You can save an XPath/XQuery expression, or longer snippets, that you have entered in the XPath/XQuery Window, together with the current settings of the window, to an XQuery file, and you can load XPath/XQuery snippets from an XQuery file. To carry out these two functions, click their respective icons (Save Snippet or Load Snippet), which are located in the window's toolbar.



After an XPath/XQuery snippet has been saved to file, it can be loaded into the XPath/XQuery Window of any XMLSpy instance (version 2022 and later). This is useful if you want to use the snippet on another machine, or pass it to another user, or even use it yourself later on the same machine. When the expression is loaded in the XPath/XQuery Window from an XQuery file, the settings of the window will automatically switch to the window settings that were saved to the file with the snippet.

Save snippet to file

To save an XPath/XQuery expression or snippet to a file, do the following:

1. Define the window settings: (i) the evaluation language; (ii) the *Where* field setting; and (iii) in the case of the *Where* field having been set to *Project*, whether external folders are to be skipped or not.
2. Enter the XPath/XQuery expression or snippet you want to save.
3. Click **Save Snippet**.
4. In the *Save As* dialog that appears, select the file, or enter the name of a new file, to which you want to save the snippet, and click **Save**.

The snippet will be saved to the file, with the window settings being saved as a comment in the first line of the file. Given below is the listing of a saved snippet file.

```
(: {"language":"XQuery3","where":"CurrentFile"} :)  
for $i in //para[count(*)=0] return $i
```

Note: If you like, you can edit this file, including the comment line that contains the window settings.

Load snippet from file

To load an XPath/XQuery snippet from a file, do the following:

1. In the tab where you want to load the expression, click **Load Snippet**.
2. In the *Open* dialog that appears, browse for the XQuery file from which you want to load the snippet and click **Open**.

The snippet will be loaded and the settings of the XPath/XQuery Window will change to those defined in the XQuery file. If no settings are stored in the file, then the settings in the XPath/XQuery Window will not change. If the *Where* setting is incorrectly set, then the window setting will default to *Current File*.

10.5 XQuery Expressions for JSON

JSON documents can be queried by entering an XPath/XQuery 3.1 query expression in the [XPath/XQuery output window](#) ¹¹⁵ (see screenshot below).

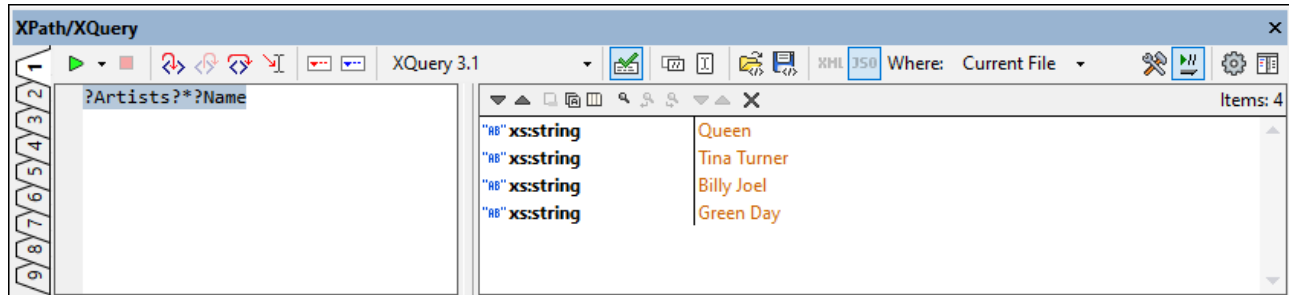

To evaluate an expression on a JSON document, do the following:

1. Select either the **XPath 3.1** icon or **XQuery 3.1** icon.
2. Ensure that the window is in JSON evaluation mode.
3. Enter the XPath 3.1 or XQuery 3.1 expression.
4. Click **Start Evaluation** (at left in the toolbar).

XQuery 3.1 expressions for JSON

Since JSON data structures commonly use objects and arrays, it is the [XQuery 3.1 lookup operator](#) `?` that is used to locate nodes inside JSON objects (which are essentially maps from an XQuery perspective) and JSON arrays. This way of locating a node is different than how path expressions are written to locate nodes in XML documents. In these, the slash operator `/` is used to connect steps in a path expression (for example: `items/*`). In XQuery expressions for JSON, the slash operator is not used for locating nodes.

Examples of XQuery expressions for JSON

`?items?*`

Read this to mean: Lookup the child node `items` and then lookup all its children nodes. Note that `items` is expected to be a child node of the context node.

`?Artists?1?Albums?2?Name`

Read this to mean: Lookup the child node `Artists` and then lookup its first child node. Inside that node, lookup the child node `Albums` and then lookup its second child node. Now return the `Name` node of that second child node.

`?Tracks?*[contains(?Writer, 'Brian')]`

Read this to mean: Lookup the child node `Tracks` and then lookup all its children. While looking up the children, lookup each child's `Writer` node children, and select only those that contain the string `'Brian'`. Notice that there are three lookup operators in this expression. Each is used in a new step, where a nodeset must be looked up.

`?Artists?*[?Name="Queen"]?Albums?*?Name`

Read this to mean: Inside the root object, lookup the child node `Artists` and then lookup all its children that have `Name` node with a value of `"Queen"`. Inside these nodes, lookup all the child `Albums` nodes, and then their

children. Inside these children, lookup (and return) the respective `Name` nodes. In the screenshot below, this expression is shown in the [XPath/XQuery Window](#)⁴¹⁹ together with the [JSON Grid View](#)⁵²⁰ representation of the target JSON document.

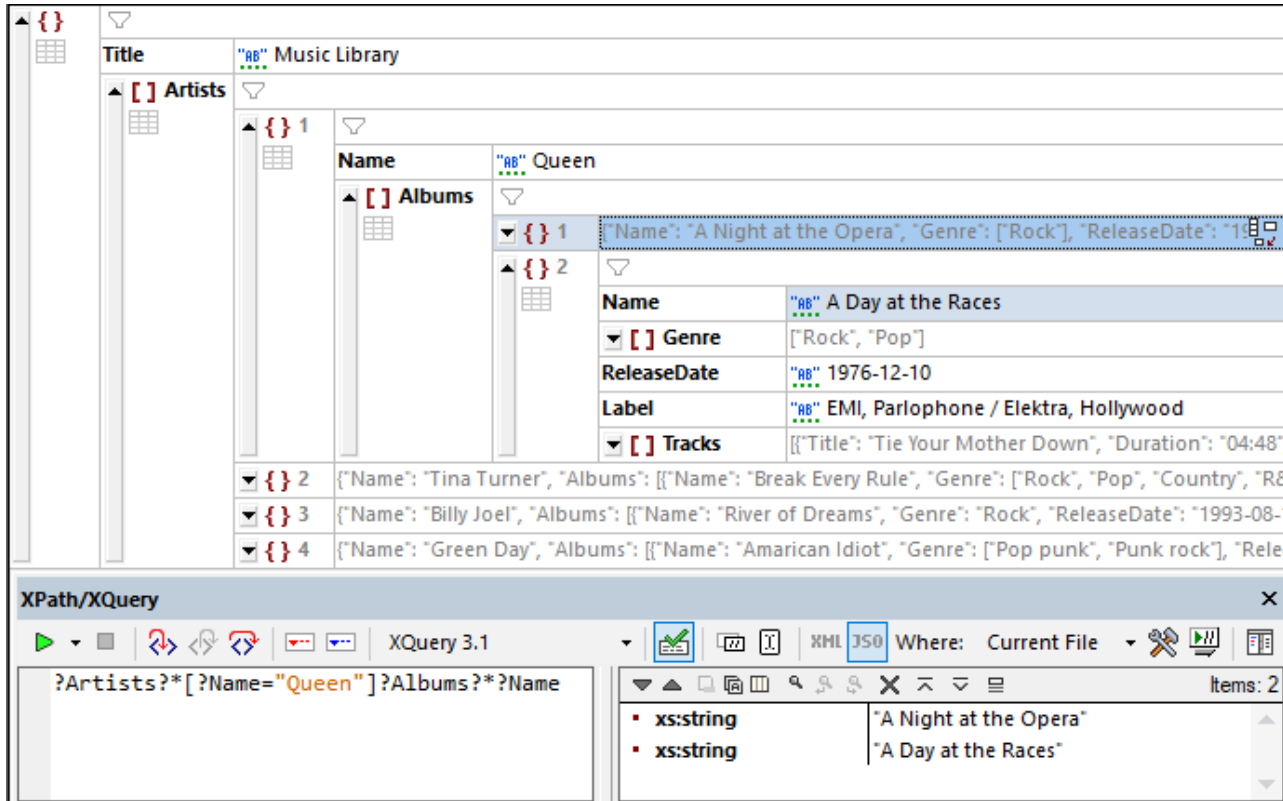

Results pane for JSON evaluation

The Results show the selected JSON components in bold in the left side of the *Results* pane, and the component's value in the right side of the pane. In the screenshot below, the results are displayed in bold. The array has been expanded to show its members.

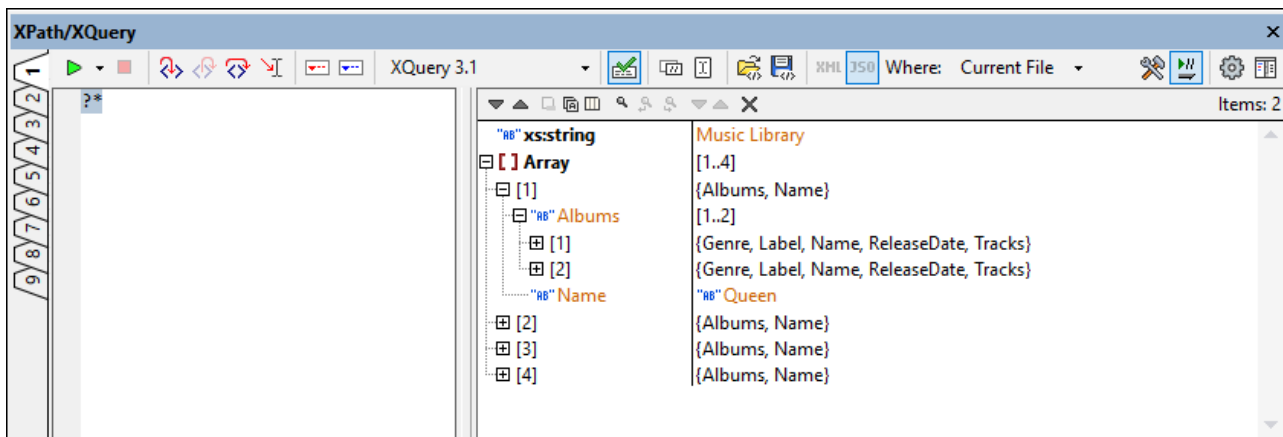

Maps and arrays are displayed in short or verbose format according to whether the *Show complete result* icon in the toolbar is toggled off or on. Maps and arrays in the left side of the pane can be expanded by clicking their respective plus icons.

10.6 Points to Note

XPath 1.0 expressions

- XPath 1.0 functions must be entered without any namespace prefix.
- The four node tests by type are supported: `node()`, `text()`, `comment()`, and `processing-instruction()`.

XPath 2.0 and 3.1 expressions

- String (e.g. 'Hello') and numeric literals (e.g. 256) are supported. To create other literals based on XML Schema types, you use a namespace-prefixed constructor (e.g. `xs:date('2004-09-02')`). The namespace prefix that you use for XML Schema types must be bound to the XML Schema namespace: `http://www.w3.org/2001/XMLSchema`, and this namespace must be declared in your XML file.
- XPath 2.0 and 3.1 functions used by the XPath Evaluator belong to the namespace `http://www.w3.org/2005/xpath-functions`. Conventionally, the prefix `fn:` is bound to this namespace. However, since this namespace is the default functions namespace used by the XPath Evaluator, you do not need to specify a prefix on functions. If you do use a prefix, make sure that the prefix is bound to the XPath Functions namespace, which you must declare in the XML document. Examples of function usage: `current-date()` (with Functions namespace not declared in XML document); `fn:current-date()` (with Functions namespace not declared in XML document, or declared in XML document and bound to prefix `fn:`). You can omit the namespace prefix even if the Functions namespace has been declared in the XML document with or without a prefix; this is because a function so used in an XPath expression is in the default namespace—which is the default namespace for functions.
- Altova's XPath extensions are in the namespace `http://www.altova.com/xslt-extensions`.

Note: To summarize the namespace issue: If you use constructors or types from the XML Schema namespace, you must declare the XML Schema namespace in the XML document and use the correct namespace prefixes in the XPath expression. You do not need to use a prefix for XPath functions.

Datatypes in XPath 2.0 and 3.1

If you are evaluating an XPath 2.0 or 3.1 expression for an XML document that references an XML Schema and is valid according to this schema, you must explicitly construct or cast datatypes that are not implicitly converted to the required datatype by an operation. In the XPath 2.0 and 3.1 Data Models used by the built-in XPath engine, all **atomized** node values from the XML document are assigned the `xs:untypedAtomic` datatype. The `xs:untypedAtomic` type works well with implicit type conversions. For example, the expression `xs:untypedAtomic("1") + 1` results in a value of 2 because the `xs:untypedAtomic` value is implicitly promoted to `xs:double` by the addition operator. Arithmetic operators implicitly promote operands to `xs:double`. Comparison operators promote operands to `xs:string` before comparing.

In some cases, however, it is necessary to explicitly convert to the required datatype. For example, if you have two elements, `startDate` and `endDate`, that are defined as being of type `xs:date` in the XML Schema, then, for example, using the XPath 2.0 expression `endDate - startDate` will show an error. On the other hand, if you use `xs:date(endDate) - xs:date(startDate)` or `(endDate cast as xs:date) - (startDate cast as xs:date)`, the expression will correctly evaluate to a singleton sequence of type `xs:dayTimeDuration`.

Note: The XPath Engines used by the XPath Evaluator are also used by the Altova XSLT Engine, so XPath 2.0 or 3.1 expressions in XSLT stylesheets that are not implicitly converted to the required datatype must be explicitly constructed as or cast to the required datatype.

String length of character and entity references

When character and entity references are used as the input string for the `string-length()` function, the references cannot be resolved, and the length of the unresolved text string is returned. Within an XSLT environment, however, these references would have meaning, and the length of the resolved string is returned.

XPath 2.0 and 3.1 Functions Support

See the [appendices](#)¹⁵⁵².

11 Authentic

Authentic View (*screenshot below*) is a graphical representation of your XML document. It enables XML documents to be displayed without markup and with appropriate formatting and data-entry features such as input fields, combo boxes, and radio buttons. Data that the user enters in Authentic View is entered into the XML file.

Nanonull, Inc.

Location:

Street: 119 Oakstreet, Suite 4876	Phone: +1 (321) 555 5155 0
City: Vereno	Fax: +1 (321) 555 5155 4
State & Zip: <input type="text" value="DC"/> <input type="text" value="29213"/>	E-mail: office@nanonull.com

Vereno Office Summary: 4 departments, 15 employees.

The company was established **in Vereno in 1995** as a privately held software company. Since 1996, Nanonull has been actively involved in developing nanoelectronic software technologies. It released the first version of its acclaimed *NanoSoft Development Suite* in February 1999. Also in 1999, Nanonull increased its capital base with investment from a consortium of private investment firms. The company has been expanding rapidly ever since.

To be able to view and edit an XML document in Authentic View, the XML document must be associated with a **StyleVision Power Stylesheet (SPS)**, which is created in Altova's StyleVision product. An SPS (.SPS file) is, in essence, an XSLT stylesheet. It specifies an output presentation for an XML file that can include data-entry mechanisms. Authentic View users can, therefore, write data back to the XML file or DB. An SPS is based on a schema and is specific to it. If you wish to use an SPS to edit an XML file in Authentic View, you must use one that is based on the same schema as that on which the XML file is based.

Using Authentic View

- If an XML file is open, you can switch to Authentic View by clicking the **Authentic** button at the bottom of the Main Window. If an SPS is not already assigned to the XML file, you will be prompted to assign one to it. You must use an SPS that is based on the same schema as the XML file.
- A new XML file is created and displayed in Authentic View by selecting the **File | New** command and then clicking the "Select a StyleVision Stylesheet" button. This new file is a template file associated with the SPS you open. It can have a variable amount of starting data already present in it. This starting data is contained in an XML file (a Template XML File) that may optionally be associated with the SPS. After the Authentic View of an XML file is displayed, you can enter data in it and save the file.

- You can also open an SPS via the **Authentic | New Document** command. If a Template XML File has been assigned to the SPS, then the data in the Template XML File is used as the starting data of the XML document template created in Authentic View.

In this section

This section contains an Authentic View tutorial, which shows you how to use Authentic View. It is followed by the section, Editing in Authentic View, which explains individual editing features in detail.

More information about Authentic View

For more information about Authentic View, see (i) the section [Authentic](#)⁴⁴⁴ | [Authentic View Interface](#)⁴⁵⁹, which describes the Authentic View editing window, and (ii) the [Authentic menu](#)⁹²⁰ section of the User Reference part of this documentation.

11.1 Authentic View Tutorial

In Authentic View, you can edit XML documents in a graphical WYSIWYG interface (*screenshot below*), just like in word-processor applications such as Microsoft Word. In fact, all you need to do is enter data. You do not have to concern yourself with the formatting of the document, since the formatting is already defined in the stylesheet that controls the Authentic View of the XML document. The stylesheet (StyleVision Power Stylesheet, shortened to SPS in this tutorial) is created by a stylesheet designer using Altova's StyleVision product.

Nanonull, Inc.	
Location: <input type="text" value="US"/>	
Street: 119 Oakstreet, Suite 4876	Phone: +1 (321) 555 5155 0
City: Vereno	Fax: +1 (321) 555 5155 4
State & Zip: <input type="text" value="DC"/> <input type="text" value="29213"/>	E-mail: office@nanonull.com

Vereno Office Summary: 4 departments, 15 employees.

The company was established **in Vereno in 1995** as a privately held software company. Since 1996, Nanonull has been actively involved in developing nanoelectronic software technologies. It released the first version of its acclaimed *NanoSoft Development Suite* in February 1999. Also in 1999, Nanonull increased its capital base with investment from a consortium of private investment firms. The company has been expanding rapidly ever since.

Editing an XML document in Authentic View involves two user actions: (i) editing the structure of the document (for example, adding or deleting document parts, such as paragraphs and headlines); and (ii) entering data (the content of document parts).

This tutorial takes you through the following steps:

- Opening an XML document in Authentic View. The key requirement for Authentic View editing is that the XML document be associated with an SPS file.
- A look at the Authentic View interface and a broad description of the central editing mechanisms.
- Editing document structure by inserting and deleting nodes.
- Entering data in the XML document.
- Entering (i) attribute values via the Attributes entry helper, and (ii) entity values.
- Printing the document.

Remember that this tutorial is intended to get you started, and has intentionally been kept simple. You will find additional reference material and feature descriptions in the [Authentic View interface](#)⁴⁵⁹ section.

Tutorial requirements

All the files you need for the tutorial are in the `Examples` folder of your Altova application folder. These files are:

- `NanonullOrg.xml` (the XML document you will open)
- `NanonullOrg.sps` (the StyleVision Power Stylesheet to which the XML document is linked)
- `NanonullOrg.xsd` (the XML Schema on which the XML document and StyleVision Power Stylesheet are based, and to which they are linked)
- `nanonull.gif` and `Altova_right_300.gif` (two image files used in the tutorial)

Note: At some points in the tutorial, we ask you to look at the XML text of the XML document (as opposed to the Authentic View of the document). If the Altova product edition you are using does not include a Text View (as with Authentic Desktop and Authentic Browser), then use a plain **text editor** like Wordpad or Notepad to view the text of the XML document.

Caution: We recommend that you use a copy of `NanonullOrg.xml` for the tutorial, so that you can always retrieve the original should the need arise.

11.1.1 Opening an XML Document in Authentic View

In Authentic View, you can edit an existing XML document or create and edit a new XML document. In this tutorial, you will open an existing XML document in Authentic View (described in this section) and learn how you can edit it (subsequent sections). Additionally, in this section is a description of how a new XML document can be created for editing in Authentic View.

Opening an existing XML document

The file you will open is `NanonullOrg.xml`. It is in the `Examples` folder of your Altova application. You can open `NanonullOrg.xml` in one of two ways:

- Click **File | Open** in your Altova product, then browse for `NanonullOrg.xml` in the dialog that appears, and click **Open**.
- Use Windows Explorer to locate the file, right-click, and select your Altova product as the application with which to open the file.

The file **NanonullOrg.xml** opens directly in Authentic View (*screenshot below*). This is because:

- The file already has a StyleVision Power Stylesheet (SPS) assigned to it, and
- In the Options dialog (Tools | Options), in the View tab, the option to open XML files in Authentic View if an SPS file is assigned has been checked. (Otherwise the file would open in Text View.)

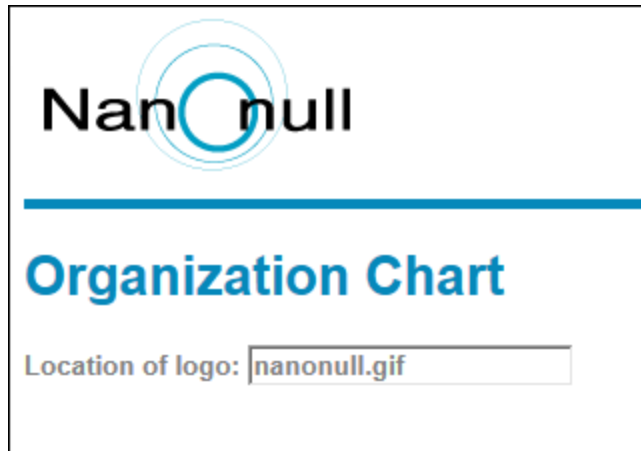

Remember: It is the SPS that defines and controls how an XML document is displayed in Authentic View. Without an SPS, there can be no Authentic View of the document.

Creating a new XML document based on an SPS

You can also create a new XML document that is based on an SPS. You can do this in two ways: via the **File | New** menu command and via the **Authentic | New Document** menu command. In both cases an SPS is selected.

Via File | New

1. Select **File | New**.
2. In the Create a New Document dialog, browse for the desired SPS.

If a Template XML File has been assigned to the SPS, then the data in the Template XML File is used as the starting data of the XML document template created in Authentic View.

Via Authentic | New Document

1. Select **Authentic | New Document**.
2. In the Create a New Document dialog, browse for the desired SPS.

If a Template XML File has been assigned to the SPS, then the data in the Template XML File is used as the starting data of the XML document template created in Authentic View.

11.1.2 The Authentic View Interface

The Authentic View editing interface consists of a main window in which you enter and edit the document data, and three entry helpers. Editing a document is simple. If you wish to see the markup of the document, switch on the markup tags. Then start typing in the content of your document. To modify the document structure, you can use either the context menu or the Elements entry helper.

Displaying XML node tags (document markup)

An XML document is essentially a hierarchy of nodes. For example:

```
<DocumentRoot>
  <Person id="ABC001">
    <Name>Alpha Beta</Name>
    <Address>Some Address</Address>
    <Tel>1234567</Tel>
  </Person>
</DocumentRoot>
```

By default, the node tags are not displayed in Authentic View. You can switch on the node tags by selecting the menu item **Authentic | Show Large Markup** (or the  toolbar icon). Large markup tags contain the names of the respective nodes. Alternatively, you can select small markup (no node names in tags) and mixed markup (a mixture of large, small, and no markup tags, which is defined by the designer of the stylesheet; the default mixed markup for the document is no markup).

You can view the text of the XML document in the Text View of your Altova product or in a text editor.

Entry helpers

There are three entry helpers in the interface (*screenshot below*), located by default along the right edge of the application window. These are the Elements, Attributes, and Entity entry helpers.

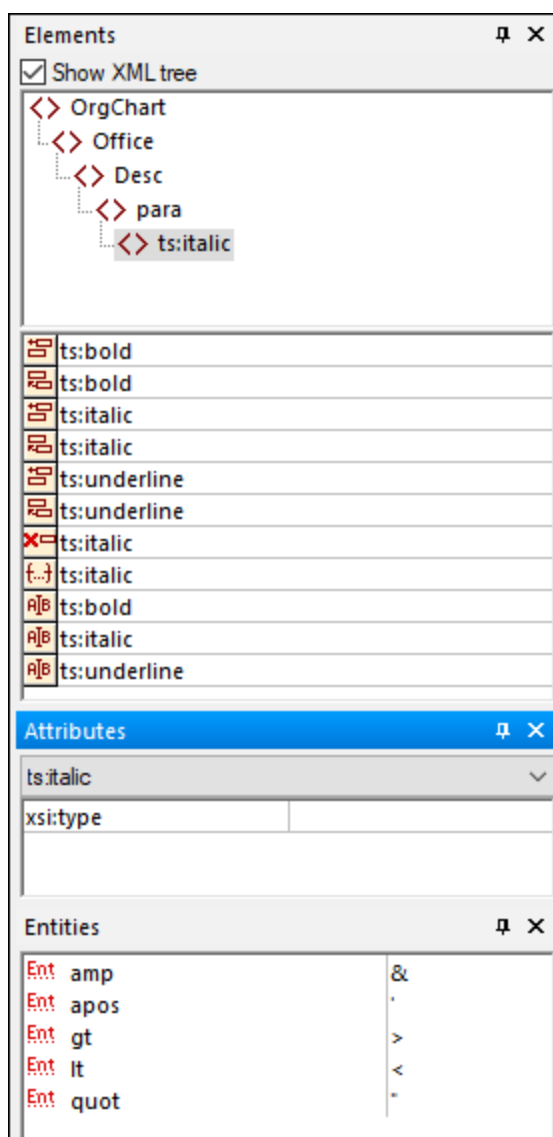

Elements entry helper

The Elements entry helper displays elements that can be inserted and removed with reference to the current location of the cursor or selection in the Main Window. Note that the entry helper is context-sensitive; its content changes according to the location of the cursor or selection. The content of the entry helper can be changed in one other way: when another node is selected in the XML tree of the Elements entry helper, the elements relevant to that node are displayed in the entry helper. The Elements entry helper can be expanded to show the XML tree by checking the Show XML Tree check box at the top of the entry helper (see *screenshot above*). The XML tree shows the hierarchy of nodes from the top-level element node all the way down to the node selected in the Main Window.

Attributes entry helper

The Attributes entry helper displays the attributes of the element selected in the Main Window, and the values of these attributes. Attribute values can be entered or edited in the Attributes entry helper. Element nodes from the top-level element down to the selected element are available for selection in the combo box of the Attributes entry helper. Selecting an element from the dropdown list of the combo box causes that element's attributes to be displayed in the entry helper, where they can then be edited.

Entities entry helper

The Entities entry helper is not context-sensitive, and displays all the entities declared for the document. Double-clicking an entity inserts it at the cursor location. How to add entities for a document is described in the section [Authentic View interface](#)⁴⁵⁹.

Context menu

Right-clicking at a location in the Authentic View document pops up a context menu relevant to that (node) location. The context menu provides commands that enable you to:

- Insert nodes at that location or before or after the selected node. Submenus display lists of nodes that are allowed at the respective insert locations.
- Remove the selected node (if this allowed by the schema) or any removable ancestor element. The nodes that may be removed (according to the schema) are listed in a submenu.
- Insert entities and CDATA sections. The entities declared for the document are listed in a submenu. CDATA sections can only be inserted within text.
- Cut, copy, paste (including pasting as XML or text), and delete document content.

Note: For more details about the interface, see [Authentic View interface](#)⁴⁵⁹.

11.1.3 Node Operations

There are two major types of nodes you will encounter in an Authentic View XML document: **element nodes** and **attribute nodes**. These nodes are marked up with tags, which you can [switch on](#)⁴⁴⁸. There are also other nodes in the document, such as text nodes (which are not marked up) and CDATA section nodes (which are marked up, in order to delimit them from surrounding text).

The node operations described in this section refer only to element nodes and attribute nodes. When trying out the operations described in this section, it is best to have [large markup switched on](#)⁴⁴⁸.



Note: It is important to remember that **only same- or higher-level elements** can be inserted before or after the selected element. Same-level elements are **siblings**. Siblings of a paragraph element would be other paragraph elements, but could also be lists, a table, an image, etc. Siblings could occur before or after an element. Higher-level elements are **ancestor** elements and siblings of ancestors. For a paragraph element, ancestor elements could be a section, chapter, article, etc. A paragraph in a valid XML file would already have ancestors. Therefore, adding a higher-level element in Authentic View, creates the new element as a sibling of the relevant ancestor. For example, if a section element is inserted after a paragraph, it is created as a sibling of the section that contains the current paragraph element.

Carrying out node operations

Node operations can be carried out by selecting a command in the [context menu](#)⁴⁵¹ or by clicking the node operation entry in the [Elements entry helper](#)⁴⁴⁹. In some cases, an element or attribute can be added by clicking the [Add Node link](#)⁴⁵² in the Authentic View of the document. In the special cases of elements defined as paragraphs or list items, pressing the [Enter key](#)⁴⁵² when within such an element creates a new sibling element of that kind. This section also describes how nodes can be created and deleted by using the [Apply Element](#)⁴⁵³, [Remove Node](#)⁴⁵³, and [Clear Element](#)⁴⁵³ mechanisms.

Inserting elements

Elements can be inserted at the following locations:

- The cursor location within an element node. The elements available for insertion at that location are listed in a submenu of the context menu's **Insert** command. In the Elements entry helper, elements that can be inserted at a location are indicated with the  icon. In the `NanonullOrg.xml` document, place the cursor inside the `para` element, and create **bold** and *italic* elements using both the context menu and Elements entry helper.
- Before or after the selected element or any of its ancestors, if allowed by the schema. Select the required element from the submenu/s that roll out. In the Elements entry helper, elements that can be inserted before or after the selected element are indicated with the  and  icons, respectively. Note that in the Elements entry helper, you can insert elements before/after the selected element only; you cannot insert before/after an ancestor element. Try out this command, by first placing the cursor inside the `para` element and then inside the table listing the employees.

Add Node link

If an element or attribute is included in the document design, and is not present in the XML document, an Add Node link is displayed at the location in the document where that node is specified. To see this link, in the line with the text, *Location of logo*, select the `@href` node within the `CompanyLogo` element and delete it (by pressing the **Delete** key). The `add @href` link appears within the `CompanyLogo` element that was edited (screenshot below). Clicking the link adds the `@href` node to the XML document. The text box within the `@href` tags appears because the design specifies that the `@href` node be added like this. You still have to enter the value (or content) of the `@href` node. Enter the text `nanonull.gif`.



If the content model of an element is ambiguous, for example, if it specifies that a sequence of child elements may appear in any order, then the `add...` link appears. Note that no node name is specified. Clicking the link will pop up a list of elements that may validly be inserted.

Note: The Add Node link appears directly in the document template; there is no corresponding entry in the context menu or Elements entry helper.

Creating new elements with the Enter key

In cases where an element has been formatted as a paragraph or list item (by the stylesheet designer), pressing the Enter key when inside such a node causes a new node of that kind to be inserted after the current node. You can try this mechanism in the `NanonullOrg.xml` document by going to the end of a `para` node (just before its end tag) and pressing **Enter**.

Applying elements



In elements of mixed content (those which contain both text and child elements), some text content can be selected and an allowed child element be applied to it. The selected text becomes the content of the applied element. To apply elements, in the context menu, select **Apply** and then select from among the applicable elements. (If no elements can be applied to the selected text, then the **Apply** command does not appear in the context menu.) In the Elements entry helper, elements that can be applied for a selection are indicated with the  icon. In the `NanonullOrg.xml` document, select text inside the mixed content `para` element and experiment with applying the `bold` and `italic` elements.

The stylesheet designer might also have created a toolbar icon to apply an element. In the `NanonullOrg.xml` document, the `bold` and `italic` elements can be applied by clicking the bold and italic icons in the application's Authentic toolbar.

Removing nodes

A node can be removed if its removal does not render the document invalid. Removing a node causes a node and all its contents to be deleted. A node can be removed using the **Remove** command in the context menu. When the Remove command is highlighted, a submenu pops up which contains all nodes that may be removed, starting from the selected node and going up to the document's top-level node. To select a node for removal, the cursor can be placed within the node, or the node (or part of it) can be highlighted. In the Elements entry helper, nodes that can be removed are indicated with the  icon. A removable node can also be removed by selecting it and pressing the **Delete** key. In the `NanonullOrg.xml` document, experiment with removing a few nodes using the mechanisms described. You can undo your changes with **Ctrl+Z**.

Clearing elements

Element nodes that are children of elements with mixed content (both text and element children) can be cleared. The entire element can be cleared when the node is selected or when the cursor is placed inside the node as an insertion point. A text fragment within the element can be cleared of the element markup by highlighting the text fragment. With the selection made, select **Clear** in the context menu and then the element to clear. In the Elements entry helper, elements that can be cleared for a particular selection are indicated with the  icon (insertion point selection) and  icon (range selection). In the `NanonullOrg.xml` document, try the clearing mechanism with the `bold` and `italic` child elements of `para` (which has mixed content).

Tables and table structure

There are two types of Authentic View table:

- *SPS tables (static and dynamic)*. The broad structure of SPS table is determined by the stylesheet designer. Within this broad structure, the only structural changes you are allowed are content-driven. For example, you could add new rows to a dynamic SPS table.
- *XML tables*, in which you decide to present the contents of a particular node (say, one for person-specific details) as a table. If the stylesheet designer has enabled the creation of this node as an XML table, then you can determine the structure of the table and edit its contents. XML tables are discussed in detail in the [Tables in Authentic View](#)⁴⁷⁷ section.

11.1.4 Entering Data in Authentic View

Data is entered into the XML document directly in the main window of Authentic View. Additionally for attributes, data (the value of the attribute) can be [entered in the Attributes entry helper](#)⁴⁵⁶. Data is entered (i) directly as text, or (ii) by selecting an option in a data-entry device, which is then mapped to a predefined text entry.

Adding text content

You can enter element content and attribute values directly as text in the main window of Authentic View. To insert content, place the cursor at the location where you want to insert the text, and type. You can also copy text from the clipboard into the document. Content can also be edited using standard editing mechanisms, such as the **Caps** and **Delete** keys. For example, you can highlight the text to be edited and type in the replacement text with the **Caps** key on.

For example, to change the name of the company, in the `Name` field of `Office`, place the cursor after Nanonull, and type in `USA` to change the name from Nanonull, Inc. to Nanonull USA, Inc.

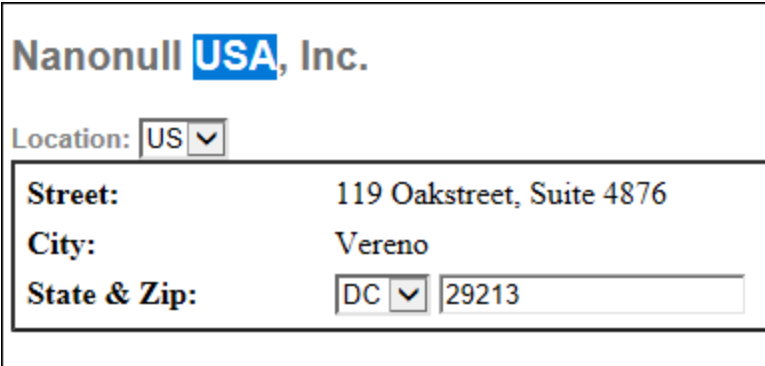

The screenshot shows a form with the following fields:

Nanonull USA , Inc.	
Location:	US ▼
Street:	119 Oakstreet, Suite 4876
City:	Vereno
State & Zip:	DC ▼ 29213

If text is editable, you will be able to place your cursor in it and highlight it, otherwise you will not be able to. Try changing any of the **field names** (not the field values), such as "Street", "City", or "State/Zip," in the address block. You are not able to place the cursor in this text because such text is not XML content; it is derived from the StyleVision Power Stylesheet.

Inserting special characters and entities

When entering data, the following type of content is handled in a special way:

- *Special characters that are used for XML markup* (ampersand, apostrophe, greater than, less than, and quotes). These characters are available as [built-in entities](#)⁴⁵⁷ and can be entered in the document by double-clicking the respective entity in the Entities entry helper. If these characters occur frequently (for example, in program code listings), then they can be entered within CDATA sections. To insert a CDATA section, right-click at the location where you wish to enter the CDATA section, and select **Insert CDATA Section** from the context menu. The XML processor ignores all markup characters within CDATA sections. This also means that if you want a special character inside a CDATA section, you should enter that character and not its entity reference.
- *Special characters that cannot be entered via the keyboard* should be entered by copying them from the character map of your system to the required location in the document.
- *A frequently used text string* can be [defined as an entity](#)⁴⁹², which appears in the Entities entry helper. The [entity is inserted](#)⁴⁵⁷ at the required locations by placing the cursor at each required location and

double-clicking the entity in the entry helper. This is useful for maintenance because the value of the text string is held in one location; if the value needs to be changed, then all that needs to be done is to change the entity definition.

Note: When markup is hidden in Authentic View, an empty element can easily be overlooked. To make sure that you are not overlooking an empty element, [switch large or small markup on](#) ⁴⁴⁸.

Try using each type of text content described above.

Adding content via a data-entry device

In the content editing you have learned above, content is added by directly typing in text as content. There is one other way that **element content** (or attribute values) can be entered in Authentic View: via data-entry devices.

Given below is a list of data-entry devices in Authentic View, together with an explanation of how data is entered in the XML file for each device.

Data-Entry Device	Data in XML File
Input Field (Text Box)	Text entered by user
Multiline Input Field	Text entered by user
Combo box	User selection mapped to value
Check box	User selection mapped to value
Radio button	User selection mapped to value
Button	User selection mapped to value

In the static table containing the address fields (*shown below*), there are two data-entry devices: an input field for the `zip` field and a combo-box for the State field. The values that you enter in the text fields are entered directly as the XML content of the respective elements. For other data-entry devices, your selection is mapped to a value.

The screenshot shows a form for 'Nanonull, Inc.' with the following fields and a dropdown menu:

- Location:** A dropdown menu with 'US' selected.
- Street:** A text input field containing 'kstreet, Suite 4876'.
- City:** A text input field.
- State & Zip:** A text input field containing '29213'.
- Vereno Office Summary:** A text input field containing 'tments, 15 employees.'

A vertical dropdown menu is open, showing state abbreviations: AK, AL, AR, AZ, CA, CO, CT, DC (highlighted), DE, FL, GA, GU.

For the Authentic View shown above, here is the corresponding XML text:

```
<Address>
  <ipo:street>119 Oakstreet, Suite 4876</ipo:street>
  <ipo:city>Vereno</ipo:city>
  <ipo:state>DC</ipo:state>
  <ipo:zip>29213</ipo:zip>
</Address>
```

Notice that the combo-box selection DC is mapped to a value of DC. The value of the zip field is entered directly as content of the `ipo:zip` element.

11.1.5 Entering Attribute Values

An attribute is a property of an element, and an element can have any number of attributes. Attributes have values. You may sometimes be required to enter XML data as an attribute value. In Authentic View, you enter attribute values in two ways:

- As content in the main window if the attribute has been created to accept its value in this way
- In the Attributes entry helper

Attribute values in the main window

Attribute values can be entered as normal text or as text in an input field, or as a user selection that will be mapped to an XML value. They are entered in the same way that element content is entered: see [Entering Data in Authentic View](#)⁴⁵⁴. In such cases, the distinction between element content and attribute value is made by the StyleVision Power Stylesheet and the data is handled appropriately.

Attribute values in the Attributes Entry Helper

If you wish to enter or change an attribute value, you can also do this in the Attributes Entry Helper. First, the attribute node is selected in Authentic View, then the value of the attribute is entered or edited in the Attributes entry helper. In the `NanonullOrg.xml` document, the location of the logo is stored as the value of the `href` attribute of the `CompanyLogo` element. To change the logo to be used:

1. Select the `CompanyLogo` element by clicking a `CompanyLogo` tag. The attributes of the `CompanyLogo` element are displayed in the Attributes Entry Helper.
2. In the Attributes Entry Helper, change the value of the `href` attribute from `nanonull.gif` to `Altova_right_300.gif` (an image in the `Examples` folder).

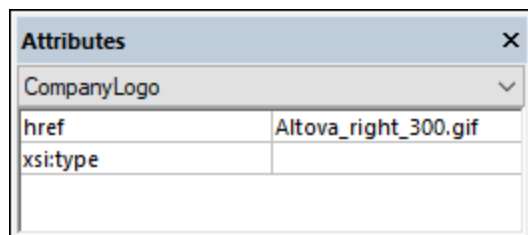

This causes the Nanonull logo to be replaced by the Altova logo.

Note: Entities cannot be entered in the Attributes entry helper.

11.1.6 Adding Entities

An entity in Authentic View is typically XML data (but not necessarily), such as a single character; a text string; and even a fragment of an XML document. An entity can also be a binary file, such as an image file. All the entities available for a particular document are displayed in the Entities Entry Helper (*screenshot below*). To insert an entity, place the cursor at the location in the document where you want to insert it, and then double-click the entity in the Entities entry helper. Note that you cannot enter entities in the Attributes entry helper.

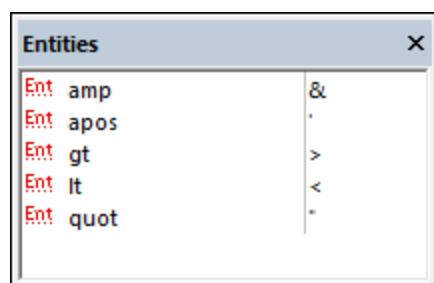

The ampersand character (&) has special significance in XML (as have the apostrophe, less than and greater than symbols, and the double quote). To insert these characters, entities are used so that they are not confused with XML-significant characters. These characters are available as entities in Authentic View.

In `NanonullOrg.xml`, change the title of Joe Martin (in Marketing) to Marketing Manager Europe & Asia. Do this as follows:

1. Place the cursor where the ampersand is to be inserted.
2. Double-click the entity listed as "amp". This inserts an ampersand (*screenshot below*).

Marketing (2)		
First	Last	Title
Joe	Martin	Marketing Manager Europe &
Susi	Sanna	Art Director
Employees: 2 (13% of Office, 5% of Company)		
Non-Shareholders: None.		

Note: The Entities Entry Helper is not context-sensitive. All available entities are displayed no matter where the cursor is positioned. This does not mean that an entity can be inserted at all locations in the document. If you are not sure, then validate the document after inserting the entity: **XML | Validate XML (F8)**.

Defining your own entities

As a document editor, you can define your own document entities. How to do this is described in the section [Defining Entities in Authentic View](#)⁴⁹².

11.1.7 Printing the Document

A printout from Authentic View of an XML document preserves the formatting seen in Authentic View.

To print `NanonullOrg.xml`, do the following:

1. Switch to Hide Markup mode if you are not already in it. You must do this if you do not want markup to be printed.
2. Select **File | Print Preview** to see a preview of all pages. Shown below is part of a print preview page, reduced by 50%. Notice that the formatting of the page is the same as that in Authentic View.

Page 1 of 5

ALTOVA

www.altova.com

Organization Chart

Location of logo:

Nanonull, Inc.

Location:

Street:	119 Oakstreet, Suite 4876	Phone:	+1 (321) 555 5155 0
City:	Vereno	Fax:	+1 (321) 555 5155 4
State & Zip:	<input type="text" value="DC"/> <input type="text" value="29213"/>	E-mail:	office@nanonull.com

Vereno Office Summary: 4 departments, 15 employees.

The company was established **in Vereno in 1995** as a privately held software company. Since 1996, Nanonull has been actively involved in developing nanoelectronic software technologies. It released the first version of its acclaimed *NanoSoft Development Suite* in February 1999. Also in 1999, Nanonull increased its capital base with investment from a consortium of private investment firms. The company has been expanding rapidly ever since.

3. To print the file, click **File | Print**.

Note that you can also print a version of the document that displays markup. To do this, switch Authentic View to Show small markup mode or Show large markup mode, and then print.

11.2 Authentic View Interface

Authentic View is enabled by clicking the Authentic tab of the active document. If no SPS has been assigned to the XML document, you are prompted to assign one. You can assign an SPS at any time via the **Authentic | Assign a Stylevision Stylesheet** command.

This section provides:

- An overview of the interface
- A description of the toolbar icons specific to Authentic View
- A description of viewing modes available in the main Authentic View window
- A description of the Entry Helpers and how they are to be used
- A description of the context menus available at various points in the Authentic View of the XML document

Additional sources of Authentic View information are:

- An Authentic View Tutorial, which shows you how to use the Authentic View interface. This tutorial is available in the documentation of the Altova XMLSpy and Altova Authentic Desktop products (see the Tutorials section), as well as [online](#).
- For a detailed description of Authentic View menu commands, see the User Reference section of your product documentation.

Altova website: [XML content editing](#), [XML authoring](#)

11.2.1 Overview of the GUI

Authentic View has a menu bar and toolbar running across the top of the window, and three areas that cover the rest of the interface: the Project Window, Main Window, and Entry Helpers Window. These areas are shown below.

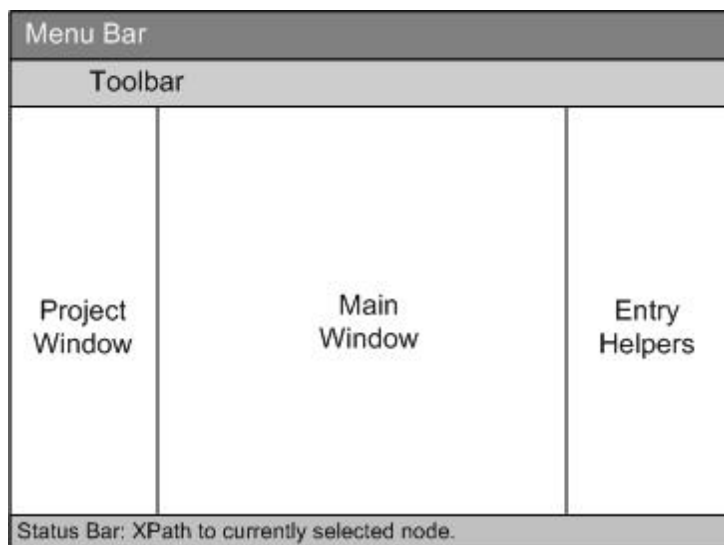

Menu bar

The menus available in the menu bar are described in detail in the User Reference section of your product documentation.

Toolbar

The symbols and icons displayed in the toolbar are described in the section, [Authentic View toolbar icons](#)⁴⁶⁰.

Project window

You can group XML, XSL, XML schema, and Entity files together in a project. To create and modify the list of project files, use the commands in the **Project** menu (described in the User Reference section of your product documentation). The list of project files is displayed in the Project window. A file in the Project window can be accessed by double-clicking it.

Info window

This window provides information about the node that is currently selected in Authentic View.

Main window

This is the window in which the XML document is displayed and edited. It is described in the section, [Authentic View main window](#)⁴⁶³.

Entry helpers

There are three entry helper windows in this area: Elements, Attributes, and Entities. What entries appear in these windows (Elements and Attributes Entry Helpers) are context-sensitive, i.e. it depends on where in the document the cursor is. You can enter an element or entity into the document by double-clicking its entry helper. The value of an attribute is entered into the value field of that attribute in the Attributes Entry Helper. See the section [Authentic View Entry Helpers](#)⁴⁶⁵ for details.

Status Bar

The Status Bar displays the XPath to the currently selected node.

Context menus

These are the menus that appear when you right-click in the Main Window. The available commands are context-sensitive editing commands, i.e. they allow you to manipulate structure and content relevant to the selected node. Such manipulations include inserting, appending, or deleting a node, adding entities, or cutting and pasting content.





11.2.2 Authentic View Toolbar Icons

Icons in the Authentic View toolbar are command shortcuts. Some icons will already be familiar to you from other Windows applications or Altova products, others might be new to you. This section describes icons unique to Authentic View. In the description below, related icons are grouped together.

Show/hide XML markup

In Authentic View, the tags for all, some, or none of the XML elements or attributes can be displayed, either with their names (large markup) or without names (small markup). The four markup icons appear in the toolbar, and the corresponding commands are available in the **Authentic** menu.



	Hide markup. All XML tags are hidden except those which have been collapsed. Double-clicking on a collapsed tag (which is the usual way to expand it) in Hide markup mode will cause the node's content to be displayed and the tags to be hidden.
	Show small markup. XML element/attribute tags are shown without names.
	Show large markup. XML element/attribute tags are shown with names.
	Show mixed markup. In the StyleVision Power Stylesheet, each XML element or attribute can be specified to display (as either large or small markup), or not to display at all. This is called mixed markup mode since some elements can be specified to be displayed with markup and some without markup. In mixed markup mode, therefore, the Authentic View user sees a customized markup. Note, however, that this customization is created by the person who has designed the StyleVision Power Stylesheet. It cannot be defined by the Authentic View user.





Editing dynamic table structures

Rows in a **dynamic SPS table** are repetitions of a data structure. Each row represents an occurrence of a single element. Each row, therefore, has the same XML substructure as the next.

The dynamic table editing commands manipulate the rows of a dynamic SPS table. That is, you can modify the number and order of the element occurrences. You cannot, however, edit the columns of a dynamic SPS table, since this would entail changing the substructure of individual element occurrences.

The icons for dynamic table editing commands appear in the toolbar, and are also available in the **Authentic** menu.



	Append row to table
	Insert row in table
	Duplicate current table row (i.e. cell contents are duplicated)
	Move current row up by one row
	Move current row down by one row



Note: These commands apply only to **dynamic SPS tables**. They should not be used inside static SPS tables. The various types of tables used in Authentic View are described in the [Using Tables in Authentic View](#)⁴⁷⁷ section of this documentation.

Creating and editing XML tables

You can insert your own tables should you want to present your data as a table. Such tables are inserted as XML tables. You can modify the structure of an XML table, and format the table. The icons for creating and editing XML tables are available in the toolbar, and are shown below. They are described in the section [XML table editing icons](#)⁴⁸².



The commands corresponding to these icons are **not available as menu items**. Note also that for you to be able to use XML tables, this function must be enabled and suitably configured in the StyleVision Power Stylesheet. A detailed description of the types of tables used in Authentic View and of how XML tables are to be created and edited is given in [Using Tables in Authentic View](#)⁴⁷⁷.

Text formatting icons

Text in Authentic View is formatted by applying to it an XML element or attribute that has the required formatting. If such formatting has been defined, the designer of the StyleVision Power Stylesheet can provide icons in the Authentic View toolbar to apply the formatting. To apply text formatting using a text formatting icon, highlight the text you want to format, and click the appropriate icon.

DB Row Navigation icons



The arrow icons are, from left to right, Go to First Record; Go to Previous Record; Open the *Go to Record #* dialog; Go to Next Record; and Go to Last Record.

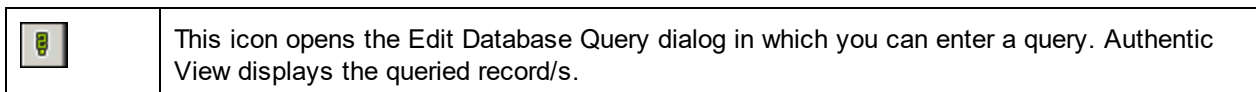

XML database editing

The **Select New Row with XML Data for Editing** command enables you to select a new row from the relevant table in an XML DB, such as IBM DB2. This row appears in Authentic View, can be edited there, and then saved back to the DB.

Portable XML Form (PXF) toolbar buttons

The following PXF toolbar buttons are available in the Authentic View of XMLSpy and Authentic Desktop:



Clicking the individual buttons generates HTML, RTF, PDF, and/or DocX output.

These buttons are enabled when a PXF file is opened in Authentic View. Individual buttons are enabled if the PXF file was configured to contain the XSLT stylesheet for that specific output format. For example, if the PXF file was configured to contain the XSLT stylesheets for HTML and RTF, then only the toolbar buttons for HTML and RTF output will be enabled while those for PDF and DocX (Word 2007+) output will be disabled.

11.2.3 Authentic View Main Window

There are four viewing modes in Authentic View: Large Markup; Small Markup; Mixed Markup; and Hide All Markup. These modes enable you to view the document with varying levels of markup information. To switch between modes, use the commands in the **Authentic** menu or the icons in the toolbar (see the previous section, [Authentic View toolbar icons](#) ⁴⁶⁰).

Large markup

This shows the start and end tags of elements and attributes with the element/attribute names in the tags:



The element `Name` in the figure above is **expanded**, i.e. the start and end tags, as well as the content of the element, are shown. An element/attribute can be **contracted** by double-clicking either its start or end tag. To expand the contracted element/attribute, double-click the contracted tag.

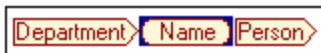

In large markup, attributes are recognized by the equals-to symbol in the start and end tags of the attribute:



Small markup

This shows the start and end tags of elements/attributes without names:

ⓧ Nanonull, Inc. ⓧ

Location: ⓧ US ⓧ

ⓧ Street: ⓧ 119 Oakstreet, Suite 4876 ⓧ City: ⓧ Vereno ⓧ State & Zip: ⓧ DC ⓧ 29213 ⓧ	Phone: ⓧ +1 (321) 555 5155 0 ⓧ Fax: ⓧ +1 (321) 555 5155 4 ⓧ E-mail: ⓧ office@nanonull.com ⓧ
---	---

ⓧ ⓧ Vereno ⓧ ⓧ **Office Summary: 4 departments, 15 employees.** ⓧ ⓧ

The company was established ⓧ in Vereno in 1995 ⓧ as a privately held software company. Since 1996, Nanonull has been actively involved in developing nanoelectronic software technologies. It released the first version of its acclaimed ⓧ NanoSoft Development Suite ⓧ in February 1999. Also in 1999, Nanonull increased its capital base with investment from a consortium of private investment firms. The company has been expanding rapidly ever since.

ⓧ ⓧ

Notice that start tags have a symbol inside them while end tags are empty. Also, element tags have an angular-brackets symbol while attribute tags have an equals sign as their symbol (see screenshot below).

ⓧ ⓧ 2006-04-01 ⓧ ⓧ Boston ⓧ ⓧ USA ⓧ ⓧ ⓧ

To collapse or expand an element/attribute, double-click the appropriate tag. The example below shows a collapsed element (highlighted in blue). Notice the shape of the tag of the collapsed element and that of the start tag of the expanded element to its left.

ⓧ ⓧ ⓧ **Office Summary: 4 departments, 15 employees.** ⓧ ⓧ

Mixed markup

Mixed markup shows a customized level of markup. The person who has designed the StyleVision Power Stylesheet can specify either large markup, small markup, or no markup for individual elements/attributes in the document. The Authentic View user sees this customized markup in mixed markup viewing mode.

Hide all markup

All XML markup is hidden. Since the formatting seen in Authentic View is the formatting of the printed document, this viewing mode is a WYSIWYG view of the document.

Content display

In Authentic View, content is displayed in two ways:

- Plain text. You type in the text, and this text becomes the content of the element or the value of the attribute.



- Data-entry devices. The display contains either an input field (text box), a multiline input field, combo box, check box, or radio button. In the case of input fields and multiline input fields, the text you enter in the field becomes the XML content of the element or the value of the attribute.



In the case of the other data-entry devices, your selection produces a corresponding XML value, which is specified in the StyleVision Power Stylesheet. Thus, in a combo box, a selection of, say, "approved" (which would be available in the dropdown list of the combo box) could map to an XML value of "1", or to "approved", or anything else; while "not approved" could map to "0", or "not approved", or anything else.

Optional nodes

When an element or attribute is **optional** (according to the referenced schema), a prompt of type `add [element/attribute]` is displayed:

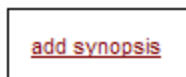

Clicking the prompt adds the element, and places the cursor for data entry. If there are multiple optional nodes, the prompt `add...` is displayed. Clicking the prompt displays a menu of the optional nodes.

11.2.4 Authentic View Entry Helpers

There are three entry helpers in Authentic View: for Elements, Attributes, and Entities. They are displayed as windows down the right side of the Authentic View interface (see *screenshot below*).

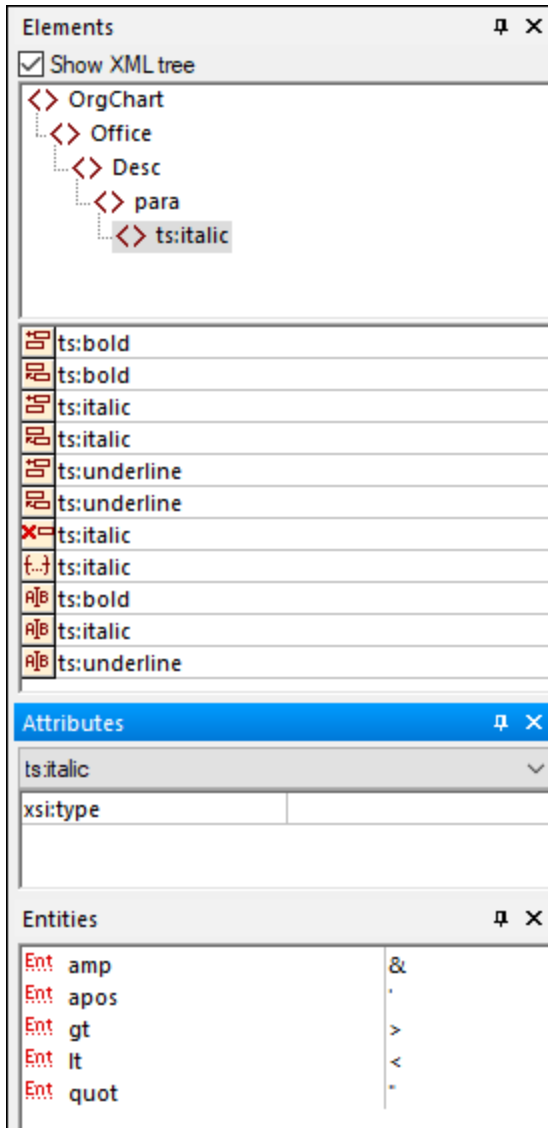

The Elements and Attributes Entry Helpers are context-sensitive, i.e. what appears in the entry helper depends on where the cursor is in the document. The entities displayed in the Entities Entry Helper are not context-sensitive; all entities allowed for the document are displayed no matter where the cursor is.

Each of the entry helpers is described separately below.

Elements Entry Helper

The Elements Entry Helper consists of two parts:

- The upper part, containing an XML tree that can be toggled on and off using the **Show XML tree** check box. The XML tree shows the ancestors up to the document's root element for the current element. When you click on an element in the XML tree, elements corresponding to that element (as described in the next item in this list) appear in the lower part of the Elements Entry Helper.

- The lower part, containing a list of the nodes that can be inserted within, before, and after; removed; applied to or cleared from the selected element or text range in Authentic View. What you can do with an element listed in the Entry Helper is indicated by the icon to the left of the element name in the Entry Helper. The icons that occur in the Elements Entry Helper are listed below, together with an explanation of what they mean.

To use a node from the Entry Helper, click its icon.



Insert After Element

The element in the Entry Helper is inserted after the selected element. Note that it is appended at the correct hierarchical level. For example, if your cursor is inside a `//sect1/para` element, and you append a `sect1` element, then the new `sect1` element will be appended not as a following sibling of `//sect1/para` but as a following sibling of the `sect1` element that is the parent of that `para` element.



Insert Before Element

The element in the Entry Helper is inserted before the selected element. Note that, just as with the **Insert After Element** command, the element is inserted at the correct hierarchical level.



Remove Element

Removes the element and its content.



Insert Element

An element from the Entry Helper can also be inserted within an element. When the cursor is placed within an element, then the allowed child elements of that element can be inserted. Note that allowed child elements can be part of an elements-only content model as well as a mixed content model (text plus child elements).

An allowed child element can be inserted either when a text range is selected or when the cursor is placed as an insertion point within the text.

- When a text range is selected and an element inserted, the text range becomes the content of the inserted element.
- When an element is inserted at an insertion point, the element is inserted at that point.

After an element has been inserted, it can be cleared by clicking either of the two **Clear Element** icons that appear (in the Elements Entry Helper) for these inline elements. Which of the two icons appears depends on whether you select a text range or place the cursor in the text as an insertion point (*see below*).



Apply Element

If you select an element in your document (by clicking either its start or end tag in the Show large markup view) and that element can be replaced by another element (for example, in a mixed content element such as `para`, an `italic` element can be replaced by the `bold` element), this icon indicates that the element in the Entry Helper can be applied to the selected (original) element. The **Apply Element** command can also be applied to a text range within an element of mixed content; the text range will be created as content of the applied element.

- If the applied element has a **child element with the same name** as a child of the original element and an instance of this child element exists in the original element, then the child element of the original is retained in the new element's content.
- If the applied element has **no child element with the same name** as that of an instantiated child of the original element, then the instantiated child of the original element is appended as a sibling of any child element or elements that the new element may have.

- If the applied element has a **child element for which no equivalent exists** in the original element's content model, then this child element is not created directly but Authentic View offers you the option of inserting it.

If a text range is selected rather than an element, applying an element to the selection will create the applied element at that location with the selected text range as its content. Applying an element when the cursor is an insertion point is not allowed.

Clear Element

This icon appears when text within an element of mixed content is selected. Clicking the icon clears the element from around the selected text range.

Clear Element (when insertion point selected)

This icon appears when the cursor is placed within an element that is a child of a mixed-content element. Clicking the icon clears the inline element.

Attributes Entry Helper

The Attributes Entry Helper consists of a drop-down combo box and a list of attributes. The element that you have selected (you can click the start or end tag, or place the cursor anywhere in the element content to select it) appears in the combo box. The Attributes Entry Helper shown in the figures below has a `para` element in the combo box. Clicking the arrow in the combo box drops down a list of all the `para` element's **ancestors up to the document's root element**, which in this case is `OrgChart`.

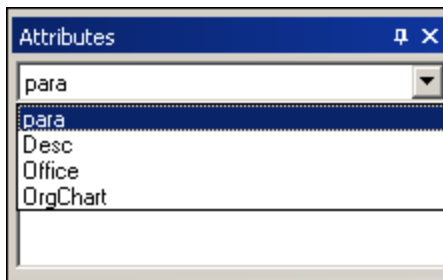

Below the combo box, a list of valid attributes for that element is displayed, in this case for `para`. If an attribute is mandatory on a given element, then it appears in bold. (In the example below, there are no mandatory attributes except the built-in attribute `xsi:type`.)

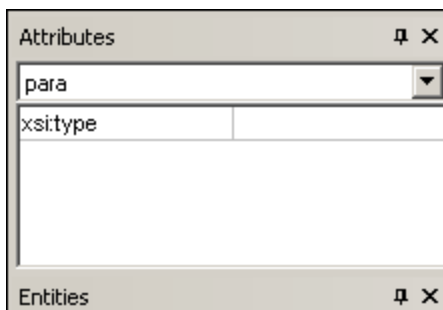

To enter a value for an attribute, click in the value field of the attribute and enter the value. This creates the attribute and its value in the XML document.

Note the following:

- In the case of the `xsi:nil` attribute, which appears in the Attributes Entry Helper when a nillable element has been selected, the value of the `xsi:nil` attribute can only be entered by selecting one of the allowed values (`true` or `false`) from the dropdown list for the attribute's value.
- The `xsi:type` attribute can be changed by clicking in the value field of the attribute and then either (i) selecting a value from the dropdown list that appears, or (ii) entering a value. Values displayed in the dropdown list are the available abstract types defined in the XML Schema on which the Authentic View document is based.

Entities Entry Helper

The Entities Entry Helper allows you to insert an entity in your document. Entities can be used to insert special characters or text fragments that occur often in a document (such as the name of a company). To insert an entity, place the cursor at the point in the text where you want to have the entity inserted, then double-click the entity in the Entities Entry Helper.

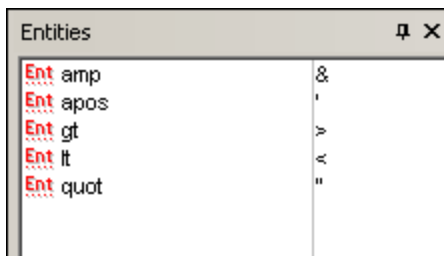

Note: An internal entity is one that has its value defined within the DTD. An external entity is one that has its value contained in an external source, e.g. another XML file. Both internal and external entities are listed in the Entities Entry Helper. When you insert an entity, whether internal or external, the entity—not its value—is inserted into the XML text. If the entity is an internal entity, Authentic View displays **the value of the entity**. If the entity is an external entity, Authentic View displays the entity—and not its value. This means, for example, that an XML file that is an external entity will be shown in the Authentic View display as an entity; its content does not replace the entity in the Authentic View display.

You can also **define your own entities** in Authentic View and these will also be displayed in the entry helper: see [Define Entities](#)⁴⁹² in the Editing in Authentic View section.

11.2.5 Authentic View Context Menus

Right-clicking on some selected document content or node pops up a context menu with commands relevant to the selection or cursor location.

Inserting elements

The figure below shows the **Insert** submenu, which is a list of all elements that can be inserted at that current cursor location. The **Insert Before** submenu lists all elements that can be inserted before the current element. The **Insert After** submenu lists all elements that can be inserted after the current element. In the figure below, the current element is the `para` element. The `bold` and `italic` elements can be inserted within the current `para` element.

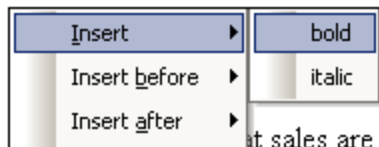

As can be seen below, the `para` and `Office` elements can be inserted before the current `para` element.

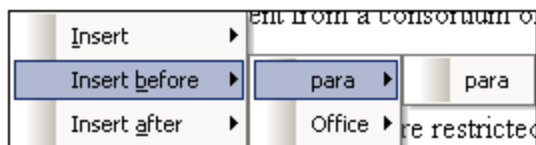

The node insertion, replacement (**Apply**), and markup removal (**Clear**) commands that are available in the context menu are also available in the [Authentic View entry helpers](#)⁴⁶⁵ and are fully described in that section.

Insert entity

Positioning the cursor over the **Insert Entity** command rolls out a submenu containing a list of all declared entities. Clicking an entity inserts it at the selection. See [Define Entities](#)⁴⁹² for a description of how to define entities for the document.

Insert CDATA Section

This command is enabled when the cursor is placed within text. Clicking it inserts a CDATA section at the cursor insertion point. The CDATA section is delimited by start and end tags; to see these tags you should switch on large or small markup. Within CDATA sections, XML markup and parsing is ignored. XML markup characters (the ampersand, apostrophe, greater than, less than, and quote characters) are not treated as markup, but as literals. So CDATA sections are useful for text such as program code listings, which have XML markup characters.

Remove node

Positioning the mouse cursor over the **Remove** command pops up a menu list consisting of the selected node and all its removable ancestors (those that would not invalidate the document) up to the document element. Click the element to be removed. This is a quick way to delete an element or any removable ancestor. Note that clicking an ancestor element will remove all its descendants, including the selected element.

Clear

The **Clear** command clears the element markup from around the selection. If the entire node is selected, then the element markup is cleared for the entire node. If a text segment is selected, then the element markup is cleared from around that text segment only.

Apply

The **Apply** command applies a selected element to your selection in the main Window. For more details, see [Authentic View entry helpers](#)⁴⁶⁵.

Copy, Cut, Paste

These are the standard Windows commands. Note, however, that the **Paste** command pastes copied text either as XML or as Text, depending on what the designer of the stylesheet has specified for the SPS as a whole. For information about how the **Copy as XML** and **Copy as Text** commands work, see the description of the **Paste As** command immediately below.

Paste As

The **Paste As** command offers the option of pasting as XML or as text an Authentic View XML fragment (which was copied to the clipboard). If the copied fragment is pasted as XML it is pasted together with its XML markup. If it is pasted as text, then only the text content of the copied fragment is pasted (not the XML markup, if any). The following situations are possible:

- An **entire node together with its markup tags** is highlighted in Authentic View and copied to the clipboard. (i) The node can be pasted as XML to any location where this node may validly be placed. It will not be pasted to an invalid location. (ii) If the node is pasted as text, then only the node's *text content* will be pasted (not the markup); the text content can be pasted to any location in the XML document where text may be pasted.
- A **text fragment** is highlighted in Authentic View and copied to the clipboard. (i) If this fragment is pasted as XML, then the XML markup tags of the text—even though these were not explicitly copied with the text fragment—will be pasted along with the text, but only if the XML node is valid at the location where the fragment is pasted. (ii) If the fragment is pasted as text, then it can be pasted to any location in the XML document where text may be pasted.

Note: Text will be copied to nodes where text is allowed, so it is up to you to ensure that the copied text does not invalidate the document. The copied text should therefore be: (i) lexically valid in the new location (for example, non-numeric characters in a numeric node would be invalid), and (ii) not otherwise invalidate the node (for example, four digits in a node that accepts only three-digit numbers would invalidate the node).

Note: If the pasted text does in any way invalidate the document, this will be indicated by the text being displayed in red.

Delete

The **Delete** command removes the selected node and its contents. A node is considered to be selected for this purpose by placing the cursor within the node or by clicking either the start or end tag of the node.

11.3 Editing in Authentic View

This section describes important features of Authentic View in detail. Features have been included in this section either because they are frequently used or because the mechanisms or concepts involved require explanation.

The section explains the following:

- There are three distinct types of tables used in Authentic View. The section [Using tables in Authentic View](#)⁴⁷⁷ explains the three types of tables (static SPS, dynamic SPS, and XML), and when and how to use them. It starts with the broad, conceptual picture and moves to the details of usage.
- The Date Picker is a graphical calendar that enters dates in the correct XML format when you click a date. See [Date Picker](#)⁴⁹¹.
- An entity is shorthand for a special character or text string. You can define your own entities, which allows you to insert these special characters or text strings by inserting the corresponding entities. See [Defining Entities](#)⁴⁹² for details.
- In the Enterprise and Professional editions of Altova products, Authentic View users can sign XML documents with [digital XML signatures](#)⁴⁹⁴ and verify these signatures.
- What [image formats](#)⁴⁹⁵ can be displayed in Authentic View.

Altova website: [XML content editing](#), [XML authoring](#)

11.3.1 Basic Editing

When you edit in Authentic View, you are editing an XML document. Authentic View, however, can hide the structural XML markup of the document, thus displaying only the content of the document (*first screenshot below*). You are therefore not exposed to the technicalities of XML, and can edit the document as you would a normal text document. If you wish, you could switch on the markup at any time while editing (*second screenshot below*).

Vereno Office Summary: 4 departments, 16 employees.

The company was established **in Vereno in 1995** as a privately held software company. Since 1996, Nanonull has been actively involved in developing nanoelectronic software technologies. It released the first version of its acclaimed *NanoSoft Development Suite* in February 1999. Also in 1999, Nanonull increased its capital base with investment from a consortium of private investment firms. The company has been expanding rapidly ever since.

An editable Authentic View document with no XML markup.

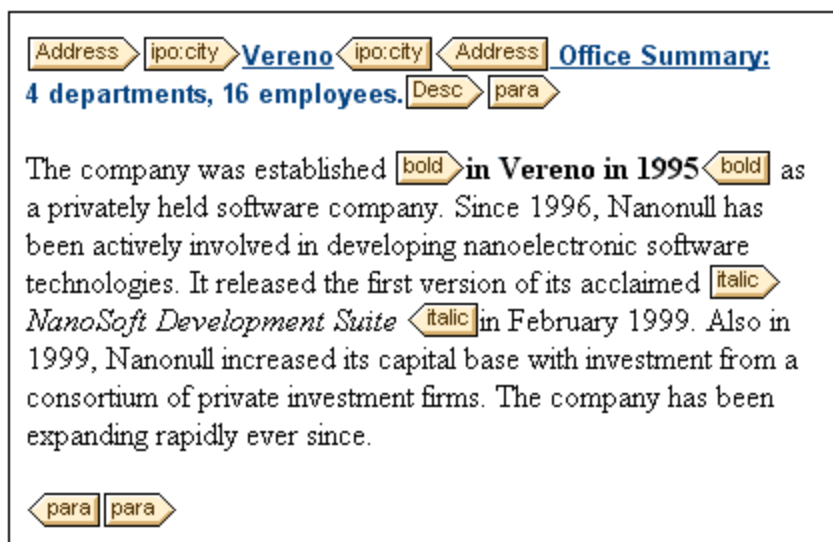

An editable Authentic View document with XML markup tags.

Inserting nodes

Very often you will need to add a new node to the Authentic XML document. For example, a new `Person` element might need to be added to an address book type of document. In such cases the XML Schema would allow the addition of the new element. All you need to do is right-click the node in the Authentic View document before which or after which you wish to add the new node. In the context menu that appears, select **Insert Before** or **Insert After** as required. The nodes available for insertion at that point in the document are listed in a submenu. Click the required node to insert it. The node will be inserted. All mandatory descendant nodes are also inserted. If a descendant node is optional, a clickable link, [Add nodeName](#), appears to enable you to add the optional node if you wish to.

If the node being added is an element with an abstract type, then a dialog (*something like in the screenshot below*) appears containing a list of derived types that are available in the XML Schema.

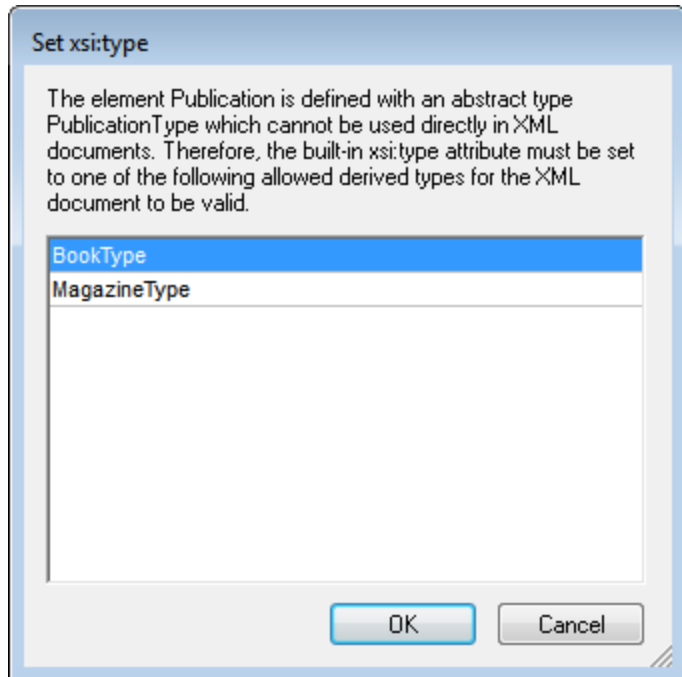

The screenshot above pops up when a `Publication` element is added. The `Publication` element is of type `PublicationType`, which is an abstract complex type. The two complex types `BookType` and `MagazineType` are derived from the abstract `PublicationType`. Therefore, when a `Publication` element is added to the XML document, one of these two concrete types derived from `Publication`'s abstract type must be specified. The new `Publication` element will be added with an `xsi:type` attribute:

```
<Publication xsi:type="BookType"> ... </Publication>
<Publication xsi:type="MagazineType"> ... </Publication>
...
<Publication xsi:type="MagazineType"> ... </Publication>
```

Selecting one of the available derived types and clicking **OK** does the following:

- Sets the selected derived type as the value of the `xsi:type` attribute of the element
- Inserts the element together with the descendant nodes defined in the content model of the selected derived type.

The selected derived type can be changed subsequently by changing the value of the element's `xsi:type` attribute in the Attributes Entry Helper. When the element's type is changed in this way, all nodes of the previous type's content model are removed and nodes of the new type's content model are inserted.

Text editing

An Authentic View document will essentially consist of text and images. To edit the text in the document, place the cursor at the location where you wish to insert text, and type. You can copy, move, and delete text using familiar keystrokes (such as the **Delete** key) and drag-and-drop mechanisms. One exception is the **Enter** key. Since the Authentic View document is pre-formatted, you do not—and cannot—add extra lines or space between items. The **Enter** key in Authentic View therefore serves to append another instance of the element currently being edited, and should be used exclusively for this purpose.

Copy as XML or as text

Text can be copied and pasted as XML or as text.

- If text is pasted as XML, then the XML markup is pasted together with the text content of nodes. The XML markup is pasted even if only part of a node's contents has been copied. For the markup to be pasted it must be allowed, according to the schema, at the location where it is pasted.
- If text is pasted as text, XML markup is not pasted.

To paste as XML or text, first copy the text (**Ctrl+C**), right-click at the location where the text is to be pasted, and select the context menu command **Paste As | XML** or **Paste As | Text**. If the shortcut **Ctrl+V** is used, the text will be pasted in the default Paste Mode of the SPS. The default Paste Mode will have been specified by the designer of the SPS. For more details, see the section [Context Menus](#)⁴⁶⁹.

Alternatively, highlighted text can be dragged to the location where it is to be pasted. When the text is dropped, a pop-up appears asking whether the text is to be pasted as text or XML. Select the desired option.

Text formatting

A fundamental principle of XML document systems is that content be kept separate from presentation. The XML document contains the content, while the stylesheet contains the presentation (formatting). In Authentic View, the XML document is presented via the stylesheet. This means that all the formatting you see in Authentic View is produced by the stylesheet. If you see bold text, that bold formatting has been provided by the stylesheet. If you see a list or a table, that list format or table format has been provided by the stylesheet. The XML document, which you edit in Authentic View contains only the content; it contains no formatting whatsoever. The formatting is contained in the stylesheet. What this means for you, the Authentic View user, is that you do not have to—nor can you—format any of the text you edit. You are editing content. The formatting that is automatically applied to the content you edit is linked to the semantic and/or structural value of the data you are editing. For example, an email address (which could be considered a semantic unit) will be formatted automatically in a certain way because it is an email. In the same way, a headline must occur at a particular location in the document (both a structural and semantic unit) and will be formatted automatically in the way the stylesheet designer has specified that headlines be formatted. You cannot change the formatting of either email address or headline. All that you do is edit the content of the email address or headline.

In some cases, content might need to be specially presented; for example, a text string that must be presented in boldface. In all such cases, the presentation must be tied in with a structural element of the document. For example, a text string that must be presented in boldface, will be structurally separated from surrounding content by markup that the stylesheet designer will format in boldface. If you, as the Authentic View user, need to use such a text string, you would need to enclose the text string within the appropriate element markup. For information about how to do this, see the Insert Element command in the [Elements Entry Helper](#)⁴⁶⁶ section of the documentation.

Using RichEdit in Authentic View

In Authentic View, when the cursor is placed inside an element that has been created as a RichEdit component, the buttons and controls in the RichEdit toolbar (*screenshot below*) become enabled. Otherwise they are grayed out.



Select the text you wish to style and specify the styling you wish to apply via the buttons and controls of the RichEdit toolbar. RichEdit enables the Authentic View user to specify the font, font-weight, font-style, font-decoration, font-size, color, background color and alignment of text. The text that has been styled will be enclosed in the tags of the styling element.

Inserting entities

In XML documents, some characters are reserved for markup and cannot be used in normal text. These are the ampersand (&), apostrophe ('), less than (<), greater than (>), and quote (") characters. If you wish to use these characters in your data, you must insert them as entity references, via the [Entities Entry Helper](#)⁴⁶⁹ (screenshot below).

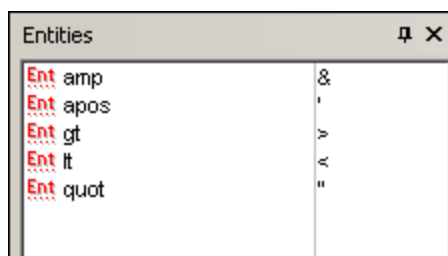

XML also offers the opportunity to create custom entities. These could be: (i) special characters that are not available on your keyboard, (ii) text strings that you wish to re-use in your document content, (iii) XML data fragments, or (iv) other resources, such as images. You can [define your own entities](#)⁴⁹² within the Authentic View application. Once defined, these entities appear in the [Entities Entry Helper](#)⁴⁶⁹ and can then be inserted as in the document.

Inserting CDATA sections

CDATA sections are sections of text in an XML document that the XML parser does not process as XML data. They can be used to escape large sections of text if replacing special characters by entity references is undesirable; this could be the case, for example, with program code or an XML fragment that is to be reproduced with its markup tags. CDATA sections can occur within element content and are delimited by `<![CDATA[` and `]]>` at the start and end, respectively. Consequently the text string `]]>` should not occur within a CDATA section as it would prematurely signify the end of the section. In this case, the greater than character should be escaped by its entity reference (`>`). To insert a CDATA section within an element, place the cursor at the desired location, right-click, and select **Insert CDATA Section** from the context menu. To see the CDATA section tags in Authentic View, [switch on the markup display](#)⁴⁶⁰. Alternatively, you could highlight the text that is to be enclosed in a CDATA section, and then select the **Insert CDATA section** command.

Note: CDATA sections cannot be inserted into input fields (that is, in text boxes and multiline text boxes). CDATA sections can only be entered within elements that are displayed in Authentic View as text content components.

Editing and following links

A hyperlink consists of two parts: the link text and the target of the link. You can edit the link text by clicking in the text and editing. But you cannot edit the target of the link. (The target of the link is set by the designer of the stylesheet (either by typing in a static target address or by deriving the target address from data contained in the XML document).) From Authentic View, you can go to the target of the link by pressing **Ctrl** and clicking the link text. (Remember: merely clicking the link will set you up for editing the link text.)

11.3.2 Tables in Authentic View

The three table types fall into two categories: SPS tables (static and dynamic) and CALS/HTML Tables.

SPS tables are of two types: static and dynamic. SPS tables are designed by the designer of the StyleVision Power Stylesheet to which your XML document is linked. You yourself cannot insert an SPS table into the XML document, but you can enter data into SPS table fields and add and delete the rows of dynamic SPS tables. The section on [SPS tables](#)⁴⁷⁷ below explains the features of these tables.

CALS/HTML tables are inserted by you, the user of Authentic View. Their purpose is to enable you to insert tables at any allowed location in the document hierarchy should you wish to do so. The editing features of [CALS/HTML Tables](#)⁴⁷⁸ and the [CALS/HTML Table editing icons](#)⁴⁸² are described below.

11.3.2.1 SPS Tables

Two types of SPS tables are used in Authentic View: static tables and dynamic tables.

Static tables

Static tables are fixed in their structure and in the content-type of cells. You, as the user of Authentic View, can enter data into the table cells but you cannot change the structure of these tables (i.e. add rows or columns, etc) or change the content-type of a cell. You enter data either by typing in text, or by selecting from options presented in the form of check-box or radio button alternatives or as a list in a combo-box. After you enter data, you can edit it.

Nanonull, Inc.	
Street:	119 Oakstreet, Suite 4876
City:	Vereno
State & Zip:	DC 29213
Phone:	+1 (321) 555 5155
Fax:	+1 (321) 555 5155 - 9
E-mail:	office@nanonull.com

Note: The icons or commands for editing dynamic tables **must not** be used to edit static tables.

Dynamic tables

Dynamic tables have rows that represent a repeating data structure, i.e. each row has an identical data structure (not the case with static tables). Therefore, you can perform row operations: append row, insert row, move row up, move row down, and delete row. These commands are available under the **Authentic** menu and as icons in the toolbar (shown below).



To use these commands, place the cursor anywhere in the appropriate row, and then select the required command.

Administration								
First	Last	Title	Ext	EMail	Shares	Leave		
						Total	Used	Left
Vernon	Callaby	Office Manager	581	v.callaby@nanonull.com	1500	25	4	21
Frank	Further	Accounts Receivable	471	f.further@nanonull.com	0	22	2	20
Loby	Matise	Accounting Manager	963	l.matise@nanonull.com	add Shares	25	7	18
Employees: 3 (20% of Office, 9% of Company)					Shares: 1500 (13% of Office, 6% of Company)			
Non-Shareholders: Frank Further, Loby Matise.								

To move among cells in the table, use the Up, Down, Left, and Right arrow keys. To move forward from one cell to the next, use the **Tab** key. Pressing the **Tab** key in the last cell of the last row creates a new row.

11.3.2.2 CALS/HTML Tables

CALS/HTML tables can be inserted by you, the user of Authentic View, for certain XML data structures that have been specified to show a table format. There are three steps involved when working with CALS/HTML tables: inserting the table; formatting it; and entering data. The commands for working with CALS/HTML tables are available as icons in the toolbar (see [CALS/HTML table editing icons](#)⁴⁸²).

Inserting tables

To insert a CALS/HTML table do the following:

1. Place your cursor where you wish to insert the table, and click the  icon. (Note that where you can insert tables is determined by the schema.) The Insert Table dialog (*screenshot below*) appears. This

dialog lists all the XML element data-structures for which a table structure has been defined. For example, in the screenshot below, the `informaltable` element and `table` element have each been defined as both a CALS table as well as an HTML table.

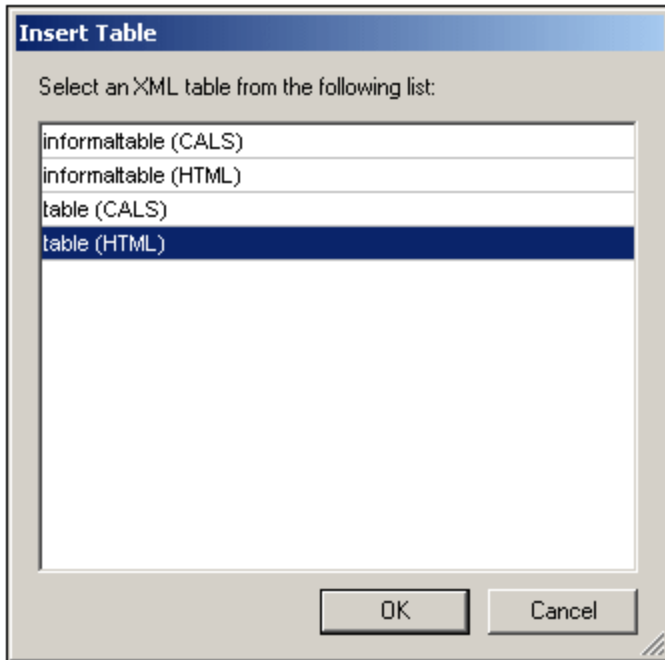

2. Select the entry containing the element and table model you wish to insert, and click **OK**.
3. In the next dialog (*screenshot below*), select the number of columns and rows, and specify whether a header and/or footer is to be added to the table and whether the table is to extend over the entire available width. Click **OK** when done.

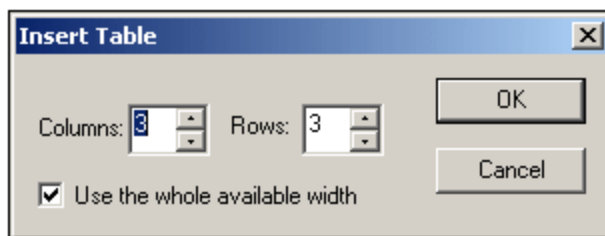

For the specifications given in the dialog box shown above, the following table is created.

By using the **Table** menu commands, you can add and delete columns, and create row and column joins and splits. But to start with, you must create the broad structure.

Formatting tables and entering data

The table formatting will already have been assigned in the document design. However, you might, under certain circumstances, be able to modify the table formatting. These circumstances are as follows:

- The elements corresponding to the various table structure elements must have the relevant CALS or HTML table properties defined as attributes (in the underlying XML Schema). Only those attributes that are defined will be available for formatting. If, in the design, values have been set for these attributes, then you can override these values in Authentic View.
- In the design, no `style` attribute containing CSS styles must have been set. If a style attribute containing CSS styles has been specified for an element, the `style` attribute has precedence over any other formatting attribute set on that element. As a result, any formatting specified in Authentic View will be overridden.

To format a table, row, column, or cell, do the following:

1. Place the cursor anywhere in the table and click the  (Table Properties) icon. This opens the Table Properties dialog (see *screenshot*), where you specify formatting for the table, or for a row, column, or cell.

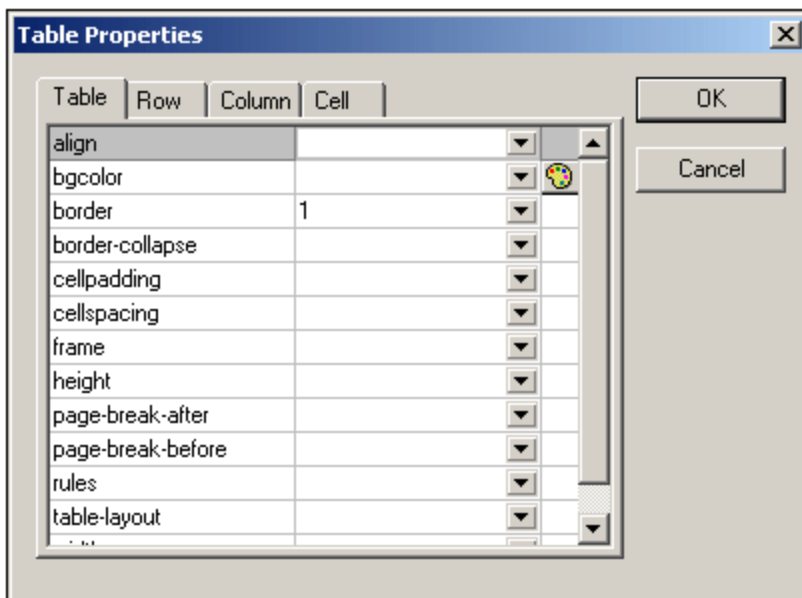

2. Set the cellspacing and cellpadding properties to "0". Your table will now look like this:

3. Place the cursor in the first row to format it, and click the  (Table Properties) icon. Click the **Row** tab.

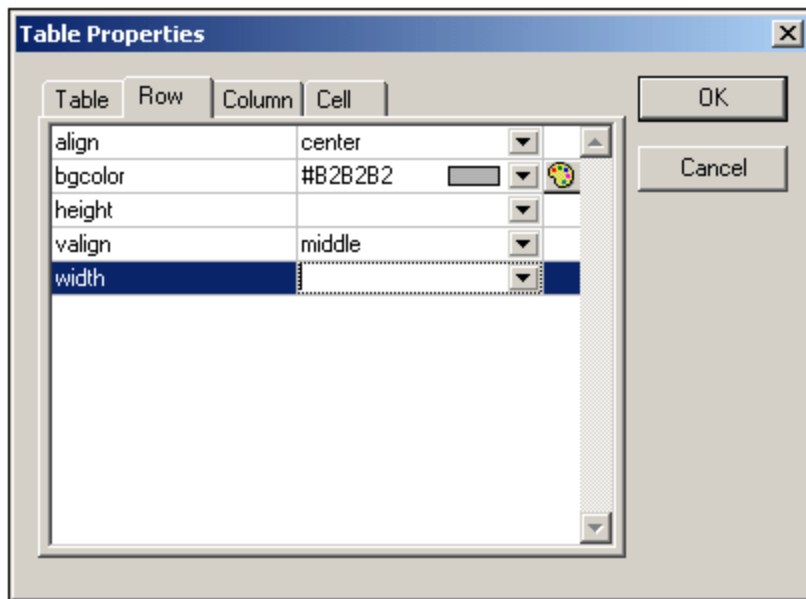

Since the first row will be the header row, set a background color to differentiate this row from the other rows. Note the Row properties that have been set in the figure above. Then enter the column header text. Your table will now look like this:

Name	Telephone	Email

Notice that the alignment is centered as specified.

4. Now, say you want to divide the "Telephone" column into the sub-columns "Office" and "Home", in which case you would need to split the horizontal width of the Telephone column into two columns. First, however, we will split the vertical extent of the header cell to make a sub-header row. Place the cursor in the "Telephone" cell, and click the  (Split vertically) icon. Your table will look like this:

Name	Telephone	Email

5. Now place the cursor in the cell below the cell containing "Telephone", and click the  (Split horizontally) icon. Then type in the column headers "Office" and "Home". Your table will now look like this:

Name	Telephone		Email
	Office	Home	

Now you will have to split the horizontal width of each cell in the "Telephone" column.

You can also add and delete columns and rows, and vertically align cell content, using the table-editing icons. The CALS/HTML table editing icons are described in the section titled, [CALS/HTML Table Editing Icons](#)⁴⁸².

Moving among cells in the table

To move among cells in the CALS/HTML table, use the Up, Down, Right, and Left arrow keys.

Entering data in a cell

To enter data in a cell, place the cursor in the cell, and type in the data.

Formatting text

Text in a CALS/HTML table, as with other text in the XML document, must be formatted using XML elements or attributes. To add an element, highlight the text and double-click the required element in the Elements Entry Helper. To specify an attribute value, place the cursor within the text fragment and enter the required attribute value in the Attributes Entry Helper. After formatting the header text bold, your table will look like this.

Name	Telephone		Email
	Office	Home	

The text above was formatted by highlighting the text, and double-clicking the element `strong`, for which a global template exists that specifies bold as the font-weight. The text formatting becomes immediately visible.

Note: For text formatting to be displayed in Authentic View, a global template with the required text formatting must have been created in StyleVision for the element in question.

11.3.2.3 CALS/HTML Table Editing Icons

The commands required to edit CALS/HTML tables are available as icons in the toolbar, and are listed below. Note that no corresponding menu commands exist for these icons. For a full description of when and how CALS/HTML Tables are to be used, see [CALS/HTML Tables](#)⁴⁷⁸.

Insert table



The "Insert Table" command inserts a **CALS/HTML table** at the current cursor position.

Delete table



The "Delete table" command deletes the currently active table.

Append row



The "Append row" command appends a row to the end of the currently active table.

Append column



The "Append column" command appends a column to the end of the currently active table.

Insert row



The "Insert row" command inserts a row above the current cursor position in the currently active table.

Insert column



The "Insert column" command inserts a column to the left of the current cursor position in the currently active table.

Join cell left



The "Join cell left" command joins the current cell (current cursor position) with the cell to the left. The tags of both cells remain in the new cell, the column headers remain unchanged and are concatenated.

Join cell right



The "Join cell right" command joins the current cell (current cursor position) with the cell to the right. The contents of both cells are concatenated in the new cell.

Join cell below



The "Join cell below" command joins the current cell (current cursor position) with the cell below. The contents of both cells are concatenated in the new cell.

Join cell above



The "Join cell above" command joins the current cell (current cursor position) with the cell above. The contents of both cells are concatenated in the new cell.

Split cell horizontally



The "Split cell Horizontally" command creates a new cell to the right of the currently active cell. The size of both cells, is now the same as the original cell.

Split cell vertically



The "Split cell Vertically" command creates a new cell below the currently active cell.

Align top



This command aligns the cell contents to the top of the cell.

Center vertically



This command centers the cell contents.

Align bottom



This command aligns the cell contents to the bottom of the cell.

Table properties



The "Table properties" command opens the Table Properties dialog box. This icon is only made active for HTML tables, it cannot be clicked for CALS tables.

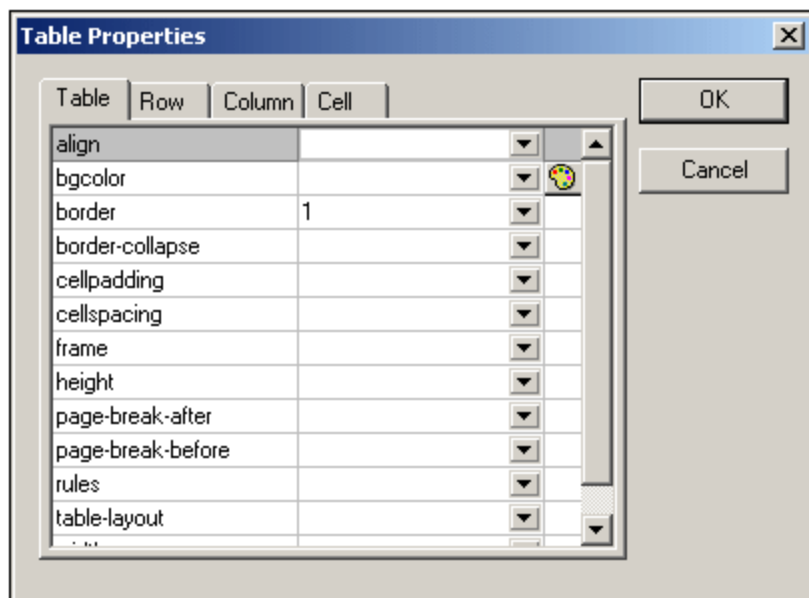

11.3.3 Editing a DB

In Authentic View, you can edit database (DB) tables and save data back to a DB. This section contains a full description of interface features available to you when editing a DB table. The following general points need to be noted:

- The number of records in a DB table that are displayed in Authentic View may have been deliberately restricted by the designer of the StyleVision Power Stylesheet in order to make the design more compact. In such cases, only that limited number of records is initially loaded into Authentic View. Using the DB table row navigation icons (see [Navigating a DB Table](#)⁴⁸⁵), you can load and display the other records in the DB table.
- You can [query the DB](#)⁴⁸⁵ to display certain records.
- You can add, modify, and delete DB records, and save your changes back to the DB. See [Modifying a DB Table](#)⁴⁸⁹.

To open a DB-based StyleVision Power Stylesheet in Authentic View, click **Authentic | Edit Database Data**, and browse for the required StyleVision Power Stylesheet.

Note: In Authentic View, data coming from a SQLite database is not editable. When you attempt to save SQLite data in Authentic View, a message box will inform you of this known limitation.

11.3.3.1 Navigating a DB Table

The commands to navigate DB table rows are available as buttons in the Authentic View document. Typically, one navigation panel with either four or five buttons accompanies each DB table.



The arrow icons are, from left to right, Go to First Record in the DB Table; Go to Previous Record; Open the Go to Record dialog (see *screenshot*); Go to Next Record; and Go to Last Record.

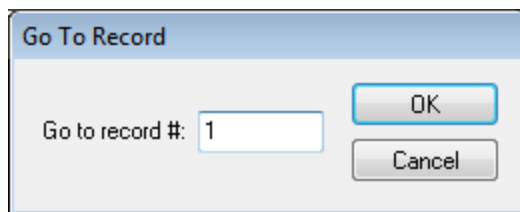

To navigate a DB table, click the required button.

XML Databases

In the case of XML DBs, such as IBM DB2, one cell (or row) contains a single XML document, and therefore a single row is loaded into Authentic View at a time. To load an XML document that is in another row, use the [Authentic | Select New Row with XML Data for Editing](#)⁹²³ menu command.

11.3.3.2 DB Queries

A DB query enables you to query the records of a table displayed in Authentic View. A query is made for an individual table, and only one query can be made for each table. You can make a query at any time while editing. If you have unsaved changes in your Authentic View document at the time you submit the query, you will be prompted about whether you wish to save **all** changes made in the document or discard **all** changes. Note that even changes made in other tables will be saved/discarded. After you submit the query, the table is reloaded using the query conditions.

Note: If you get a message saying that too many tables are open, then you can reduce the number of tables that are open by using a query to filter out some tables.

To create and submit a query:

1. Click the Query button  for the required table in order to open the Edit Database Query dialog (see *screenshot*). This button typically appears at the top of each DB table or below it. If a Query button is

not present for any table, the designer of the StyleVision Power Stylesheet has not enabled the DB Query feature for that table.

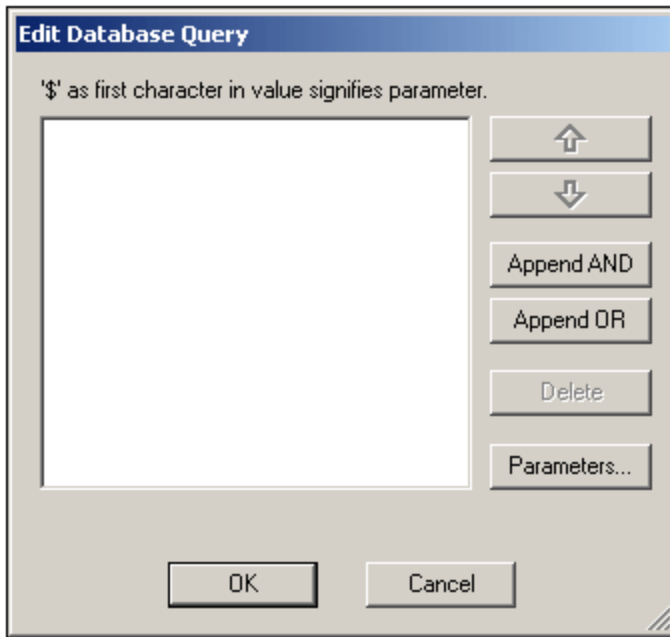

2. Click the **Append AND** or **Append OR** button. This appends an empty criterion for the query (shown below).

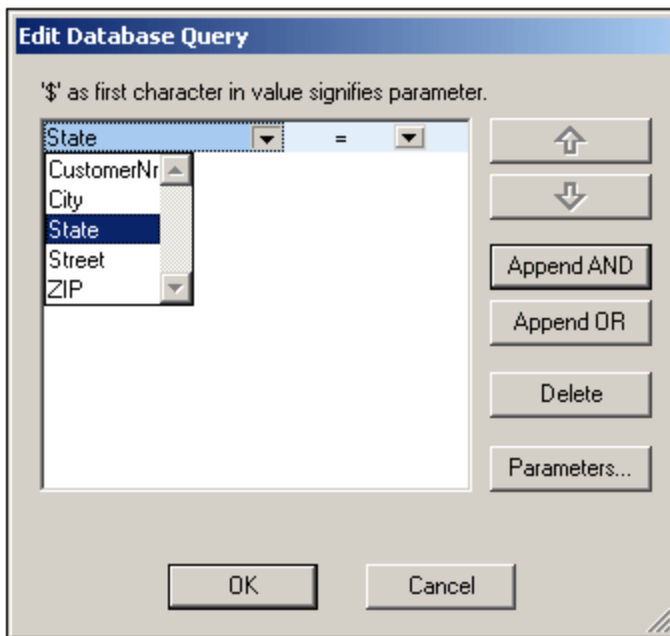

3. Enter the expression for the criterion. An expression consists of: (i) a field name (available from the associated combo-box); (ii) an operator (available from the associated combo-box); and (iii) a value (to be entered directly). For details of how to construct expressions see the [Expressions in criteria](#)⁴⁸⁷ section.

- If you wish to add another criterion, click the **Append AND** or **Append OR** button according to which logical operator (AND or OR) you wish to use to join the two criteria. Then add the new criterion. For details about the logical operators, see the section [Re-ordering criteria in DB Queries](#)⁴⁸⁸.

Expressions in criteria

Expressions in DB Query criteria consist of a field name, an operator, and a value. The **available field names** are the child elements of the selected top-level data table; the names of these fields are listed in a combo-box (see screenshot above). The **operators** you can use are listed below:

=	Equal to
<>	Not equal to
<	Less than
<=	Less than or equal to
>	Greater than
>=	Greater than or equal to
LIKE	Phonetically alike
NOT LIKE	Phonetically not alike
IS NULL	Is empty
NOT NULL	Is not empty

If `IS NULL` or `NOT NULL` is selected, the Value field is disabled. **Values** must be entered without quotes (or any other delimiter). Values must also have the same formatting as that of the corresponding DB field; otherwise the expression will evaluate to `FALSE`. For example, if a criterion for a field of the `date` datatype in an MS Access DB has an expression `StartDate=25/05/2004`, the expression will evaluate to `FALSE` because the `date` datatype in an MS Access DB has a format of `YYYY-MM-DD`.

Using parameters with DB Queries

You can enter the name of a **parameter** as the value of an expression when creating queries. Parameters are variables that can be used instead of literal values in queries. When you enter it in an expression, its value is used in the expression. Parameters that are available have been defined by the SPS designer in the SPS and can be viewed in the View Parameters dialog (see screenshot below). Parameters have been assigned a default value in the SPS, which can be overridden by passing a value to the parameter via the command line (if and when the output document is compiled via the command line).

To view the parameters defined for the SPS, click the **Parameters** button in the Edit Database Query dialog. This opens the **View Parameters** dialog (see screenshot).

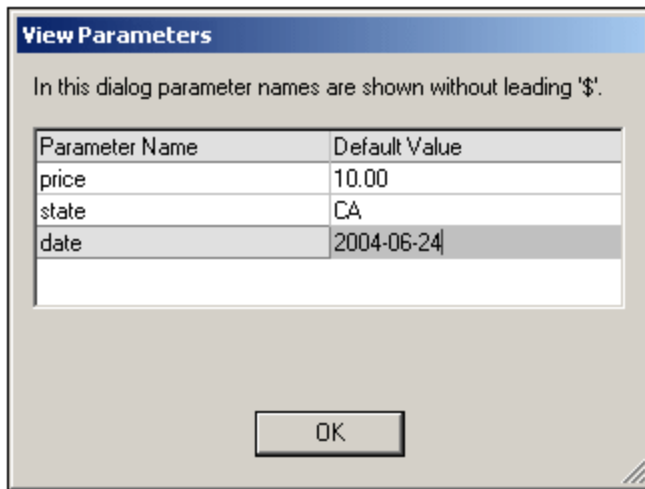

The View Parameters dialog contains **all** the parameters that have been defined for the stylesheet in the SPS and parameters must be edited in the stylesheet design.

Re-ordering criteria in DB Queries

The logical structure of the DB Query and the relationship between any two criteria or sets of criteria is indicated graphically. Each level of the logical structure is indicated by a square bracket. Two adjacent criteria or sets of criteria indicate the AND operator, whereas if two criteria are separated by the word **OR** then the OR operator is indicated. The criteria are also appropriately indented to provide a clear overview of the logical structure of the DB Query.

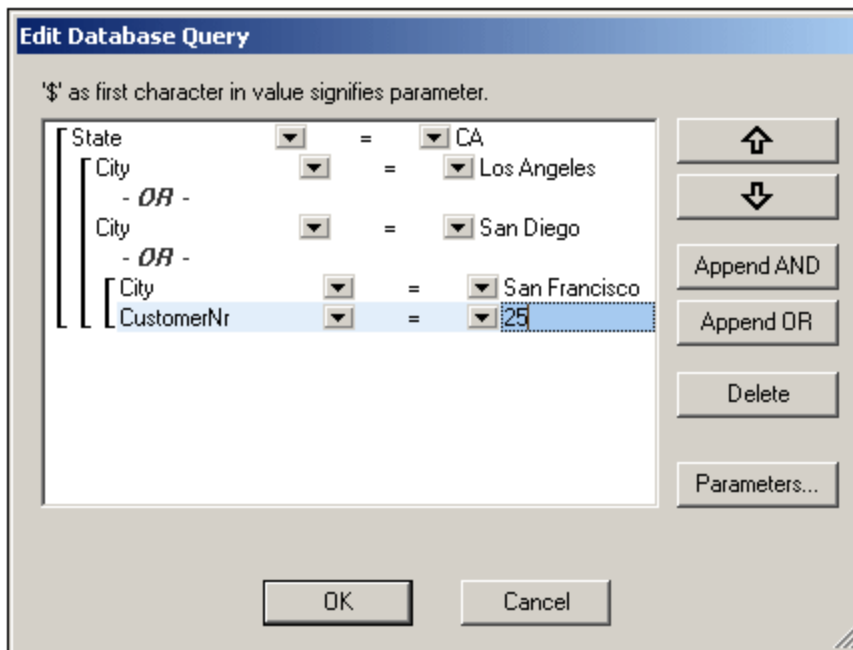

The DB Query shown in the screenshot above may be represented in text as:

```
State=CA AND (City=Los Angeles OR City=San Diego OR (City=San Francisco AND  
CustomerNr=25))
```

You can re-order the DB Query by moving a criterion or set of criteria up or down relative to the other criteria in the DB Query. To move a criterion or set of criteria, do the following:

1. Select the criterion by clicking on it, or select an entire level by clicking on the bracket that represents that level.
2. Click the Up or Down arrow button in the dialog.

The following points should be noted:

- If the adjacent criterion in the direction of movement is at the same level, the two criteria exchange places.
- A set of criteria (i.e. criterion within a bracket) changes position within the same level; it does not change levels.
- An individual criterion changes position within the same level. If the adjacent criterion is further outward/inward (i.e. not on the same level), then the selected criterion will move outward/inward, **one level at a time**.

To delete a criterion in a DB Query, select the criterion and click **Delete**.

Modifying a DB Query

To modify a DB Query:

1. Click the Query button . The Edit Database Query dialog box opens. You can now edit the expressions in any of the listed criteria, add new criteria, re-order criteria, or delete criteria in the DB Query.
2. Click **OK**. The data from the DB is automatically re-loaded into Authentic View so as to reflect the modifications to the DB Query.

11.3.3.3 Modifying a DB Table

Adding a record

To add a record to a DB table:

1. Place the cursor in the DB table row and click the  icon (to append a row) or the  icon (to insert a row). This creates a new record in the temporary XML file.
2. Click the **File | Save** command to add the new record in the DB. In Authentic View a row for the new record is appended to the DB table display. The `AltovaRowStatus` for this record is set to `A` (for Added).

When you enter data for the new record it is entered in bold and is underlined. This enables you to differentiate added records from existing records—if existing records have not been formatted with these text formatting properties. Datatype errors are flagged by being displayed in red.

The new record is added to the DB when you click **File | Save**. After a new record is saved to the DB, its `AltovaRowStatus` field is initialized (indicated with ---) and the record is displayed in Authentic View as a regular record.

Modifying a record

To modify a record, place the cursor at the required point in the DB table and edit the record as required. If the number of displayed records is limited, you may need to navigate to the required record (see [Navigating a DB Table](#)⁴⁸⁵).

When you modify a record, entries in all fields of the record are underlined and the `AltovaRowStatus` of all primary instances of this record is set to `U` (for Updated). All secondary instances of this record have their `AltovaRowStatus` set to `u` (lowercase). Primary and secondary instances of a record are defined by the structure of the DB—and correspondingly of the XML Schema generated from it. For example, if an Address table is included in a Customer table, then the Address table can occur in the Design Document in two types of instantiations: as the Address table itself and within instantiations of the Customer table. Whichever of these two types is modified is the type that has been primarily modified. Other types—there may be more than one other type—are secondary types. Datatype errors are flagged by being displayed in red.

The modifications are saved to the DB by clicking **File | Save**. After a modified record is saved to the DB, its `AltovaRowStatus` field is initialized (indicated with ---) and the record is displayed in Authentic View as a regular record.

Note the following points:

- If even a single field of a record is modified in Authentic View, the entire record is updated when the data is saved to the DB.
- The date value `0001-01-01` is defined as a `NULL` value for some DBs, and could result in an error message.

Deleting a record

To delete a record:

1. Place the cursor in the row representing the record to be deleted and click the  icon. The record to be deleted is marked with a strikethrough. The `AltovaRowStatus` is set as follows: primary instances of the record are set to `D`; secondary instances to `d`; and records indirectly deleted to `X`. Indirectly deleted records are fields in the deleted record that are held in a separate table. For example, an Address table might be included in a Customer table. If a Customer record were to be deleted, then its corresponding Address record would be indirectly deleted. If an Address record in the Customer table were deleted, then the Address record in the Customer table would be primarily deleted, but the same record would be secondarily deleted in an independent Address table if this were instantiated.
2. Click **File | Save** to save the modifications to the DB.

Note: Saving data to the DB resets the Undo command, so you cannot undo actions that were carried out prior to the save.

11.3.4 Working with Dates

There are two ways in which dates can be edited in Authentic View:

- Dates are entered or modified using the [Date Picker](#)⁴⁹¹.
- Dates are entered or modified by [typing in the value](#)⁴⁹².

The method the Authentic View user will use is defined in the SPS. Both methods are described in the two sub-sections of this section.

Note on date formats

In the XML document, dates can be stored in one of several date datatypes. Each of these datatypes requires that the date be stored in a particular lexical format in order for the XML document to be valid. For example, the `xs:date` datatype requires a lexical format of `YYYY-MM-DD`. If the date in an `xs:date` node is entered in anything other than this format, then the XML document will be invalid.

In order to ensure that the date is entered in the correct format, the SPS designer can include the graphical Date Picker in the design. This would ensure that the date selected in the Date Picker is entered in the correct lexical format. If there is no Date Picker, the Authentic View should take care to enter the date in the correct lexical format. Validating the XML document could provide useful tips about the required lexical format.

11.3.4.1 Date Picker

The Date Picker is a graphical calendar used to enter dates in a standard format into the XML document. Having a standard format is important for the processing of data in the document. The Date Picker icon appears near the date field it modifies (see *screenshot*).



To display the Date Picker (see *screenshot*), click the Date Picker icon.

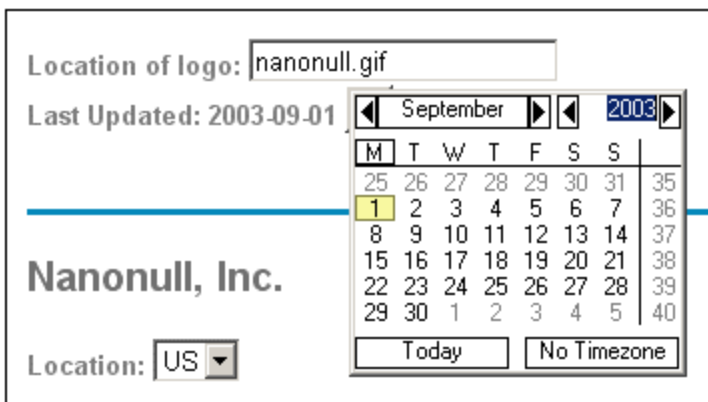

To select a date, click on the desired date, month, or year. The date is entered in the XML document, and the date in the display is modified accordingly. You can also enter a time zone if this is required.

11.3.4.2 Text Entry

For date fields that do not have a Date Picker (see *screenshot*), you can edit the date directly by typing in the new value.

Invoice Number: 001 2006-03-10 Customer: The ABC Company Invoice Amount: 40.00

Errors

The following types of error will be flagged:

- If you edit a date and change it such that it is out of the valid range for dates, the date turns red to alert you to the error. If you place the mouse cursor over the invalid date, an error message appears (see *screenshot*).

Invoice Number: 001 2006-03-32 Customer: ERROR: Invalid value for datatype date in element Invoice Amount: 40.00

- If you try to change the format of the date, the date turns red to alert you to the error. (In the screenshot below, slashes are used instead of hyphens).

Invoice Number: 001 2006/03/10 Customer: The ABC Company Invoice Amount: 40.00

11.3.5 Defining Entities

About entities

You can define entities for use in Authentic View, whether your document is based on a DTD or an XML Schema. Once defined, these entities are displayed in the Entities Entry Helper and in the **Insert Entity** submenu of the context menu. When you double-click on an entity in the Entities Entry Helper, that entity is inserted at the cursor insertion point.

An entity is useful if you will be using a text string, XML fragment, or some other external resource in multiple locations in your document. You define the entity, which is basically a short name that stands in for the required data, in the Define Entities dialog. After defining an entity you can use it at multiple locations in your document. This helps you save time and greatly enhances maintenance.

Types of entity

There are two broad types of entity you can use in your document: a **parsed entity**, which is XML data (either a text string or a fragment of an XML document), or an **unparsed entity**, which is non-XML data such as a binary file (usually a graphic, sound, or multimedia object). Each entity has a name and a value. In the case of parsed entities the entity is a placeholder for the XML data. The value of the entity is either the XML data itself or a URI that points to a .xml file that contains the XML data. In the case of unparsed entities, the value of the entity is a URI that points to the non-XML data file.

Defining entities

To define an entity:

1. Click **Authentic | Define XML Entities**. This opens the Define Entities dialog (*screenshot below*).

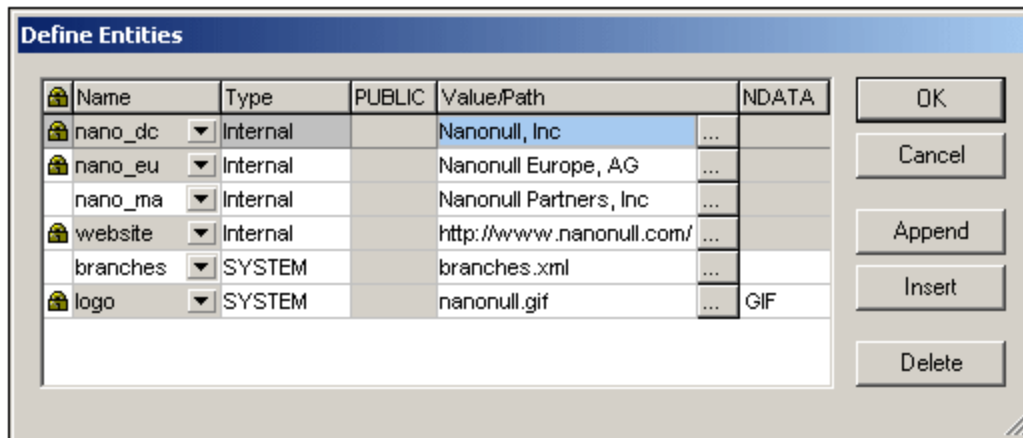

2. Enter the name of your entity in the Name field. This is the name that will appear in the Entities Entry Helper.
3. Enter the type of entity from the drop-down list in the Type field. The following types are possible: An **Internal** entity is one for which the text to be used is stored in the XML document itself. Selecting **PUBLIC** or **SYSTEM** specifies that the resource is located outside the XML file, and will be located with the use of a public identifier or a system identifier, respectively. A system identifier is a URI that gives the location of the resource. A public identifier is a location-independent identifier, which enables some processors to identify the resource. If you specify both a public and system identifier, the public identifier resolves to the system identifier, and the system identifier is used.
4. If you have selected PUBLIC as the Type, enter the public identifier of your resource in the PUBLIC field. If you have selected Internal or SYSTEM as your Type, the PUBLIC field is disabled.
5. In the Value/Path field, you can enter any one of the following:
 - If the entity type is Internal, enter the text string you want as the value of your entity. Do not enter quotes to delimit the entry. Any quotes that you enter will be treated as part of the text string.
 - If the entity type is SYSTEM, enter the URI of the resource or select a resource on your local network by using the Browse button. If the resource contains parsed data, it must be an XML file (i.e., it must have a .xml extension). Alternatively, the resource can be a binary file, such as a GIF file.

- If the entity type is PUBLIC, you must additionally enter a system identifier in this field.
6. The NDATA entry tells the processor that this entity is not to be parsed but to be sent to the appropriate processor. The NDATA field must therefore contain some value to indicate that the entity is an unparsed entity.

Dialog features

You can do the following in the Define Entities dialog:

- Append entities
- Insert entities
- Delete entities
- Sort entities by the alphabetical value of any column by clicking the column header; clicking once sorts in ascending order, twice in descending order.
- Resize the dialog box and the width of columns.
- Locking. Once an entity is used in the XML document, it is locked and cannot be edited in the Define Entities dialog. Locked entities are indicated by a lock symbol in the first column. Locking an entity ensures that the XML document is valid with respect to entities. (The document would be invalid if an entity is referenced but not defined.)
- Duplicate entities are flagged.

Limitations of entities

- An entity contained within another entity is not resolved, either in the dialog, Authentic View, or XSLT output, and the ampersand character of such an entity is displayed in its escaped form, i.e. `&`.
- External unparsed entities that are not image files are not resolved in Authentic View. If an image in the design is defined to read an external unparsed entity and has its URI set to be an entity name (for example: 'logo'), then this entity name can be defined in the Define Entities dialog (see *screenshot above*) as an external unparsed entity with a value that resolves to the URI of the image file (as has been done for the logo entity in the screenshot above).

11.3.6 XML Signatures

An SPS can be designed with an XML signature configured for Authentic View. When XML signatures are enabled in the SPS, the Authentic View user can digitally sign the Authentic XML file with the enabled signature. After the document has been signed, any modification to it will cause the verification of the signature to fail. Whenever a signed Authentic XML document is opened in the Authentic View of any Altova product, the verification process will be run on the document and the result of the verification will be displayed in a window.

Note: XML signatures can be used, and will be verified, in the Authentic View of Enterprise and Professional editions of the following Altova products: Authentic Desktop, Authentic Browser, XMLSpy, and StyleVision.

XML signature actions

The following Authentic View user actions for signatures are possible:

- *Choosing the certificate/password:* Signatures are authenticated with either a certificate or a password. The authentication object (certificate or password) is required when the signature is created and again when it is verified. If an Authentic XML document has a signature-enabled SPS assigned to it, the SPS might specify a default certificate or password for the signature. Whether a default certificate or password has been specified or not, the signature can be configured to allow the Authentic View user to select an own certificate/password. The Authentic View user can do this at any time in the XML Signature dialog (*screenshot below*). Selecting an own certificate/password overrides the default certificate/password. The own certificate/password is stored in memory and is used for the current session. If, after an own certificate/password has been selected, the Authentic View user closes the file or the application, the SPS reverts to its default setting for the certificate/password.

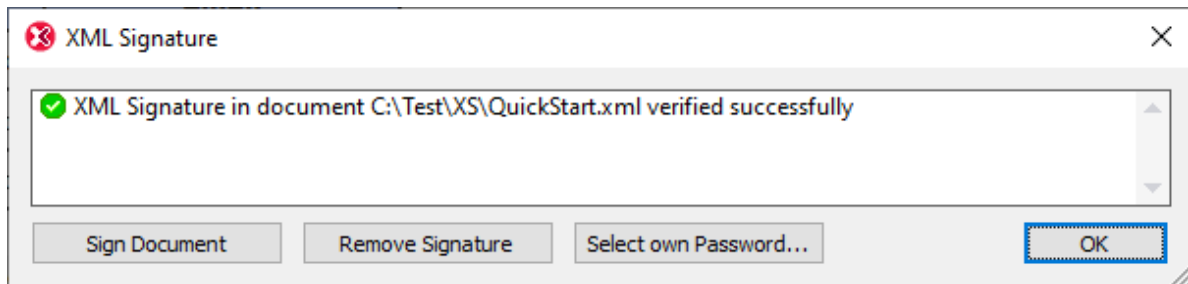

- *Signing the document:* The Authentic XML document can be signed either automatically or manually. Automatic signing will have been specified in the signature configuration by the SPS designer and causes the Authentic XML document to be signed automatically when it is saved. If the automatic-signing option has not been activated, the document can be signed manually. This is done by clicking the XML Signature toolbar icon  or the **Authentic | XML Signature** command, and, in the XML Signature dialog that then pops up (*screenshot above*), clicking the **Sign Document** button. Note that signing the document with an embedded signature would require the schema to allow the `Signature` element as the last child element of the root (document) element. Otherwise the document will be invalid against the schema. When signing the document, the authentication object and the placement of the signature are determined according to the signature configuration. You must ensure that you have access to the authentication information. For more information about this, consult your SPS designer.
- *Verifying the Authentic XML document:* If an SPS has XML Signatures enabled, the verification process will be run on the signature each time the Authentic View XML document is loaded. If the password or certificate key information is not saved with the SPS and signature, respectively, the Authentic View user will be prompted to enter the password or select a certificate for verification. Note that if an embedded signature is generated, it will be saved with the XML file when the XML file is saved. The generated signature must be explicitly removed (via the **Remove Signature** button of the XML Signature dialog; *see screenshot above*) if you do not wish to save it with the XML file. Similarly, if a detached signature is generated, it too must be explicitly removed if it is not required.

11.3.7 Images in Authentic View

Authentic View allows you to specify images that will be used in the final output document (HTML, RTF, PDF and Word 2007). You should note that some image formats might not be supported in some formats or by some applications. For example, the SVG format is supported in PDF, but not in RTF and would require a browser add-on for it to be viewed in HTML. So, when selecting an image format, be sure to select a format that

is supported in the output formats of your document. Most image formats are supported across all the output formats (*see list below*).

Authentic View is based on Internet Explorer, and is able to display most of the image formats that your version of Internet Explorer can display. The following commonly used image formats are supported:

- GIF
- JPG
- PNG
- BMP
- WMF (Microsoft Windows Metafile)
- EMF (Enhanced Metafile)
- SVG (for PDF output only)

Relative paths

Relative paths are resolved relative to the SPS file.

11.3.8 Keystrokes in Authentic View

The Enter key

In Authentic View the **Enter** key is used to append additional elements when it is in certain cursor locations. For example, if the chapter of a book may (according to the schema) contain several paragraphs, then pressing **Enter** inside the text of the paragraph causes a new paragraph to be appended immediately after the current paragraph. If a chapter can contain one title and several paragraphs, pressing **Enter** inside the chapter but outside any paragraph element (including within the title element) causes a new chapter to be appended after the current chapter (assuming that multiple chapters are allowed by the schema).

Note: The **Enter** key does **not** insert a new line. This is the case even when the cursor is inside a text node, such as paragraph.

Using the keyboard

The keyboard can be used in the standard way, for typing and navigating. Note the following special points:

- The **Tab** key moves the cursor forward, stopping before and after nodes, and highlighting node contents; it steps over static content.
- The `add...` and `add Node` hyperlinks are considered node contents and are highlighted when tabbed. They can be activated by pressing either the spacebar or the **Enter** key.

11.4 Authentic Scripting

The **Authentic Scripting** feature provides more flexibility and interactivity to SPS designs. These designs can be created or edited in StyleVision Enterprise and Professional editions, and can be viewed in the Authentic View of the Enterprise and Professional editions of Altova products.

A complete listing of support for this feature in Altova products is given in the table below. Note, however, that in the trusted version of Authentic Browser plug-in, internal scripting is turned off because of security concerns.

Altova Product	Authentic Scripts Creation	Authentic Scripts Enabled
StyleVision Enterprise	Yes	Yes
StyleVision Professional	Yes	Yes
StyleVision Standard *	No	No
XMLSpy Enterprise	No	Yes
XMLSpy Professional	No	Yes
XMLSpy Standard	No	No
AuthenticDesktop Enterprise	No	Yes
Authentic Browser Plug-in Enterprise Trusted **	No	Yes
Authentic Browser Plug-in Enterprise Untrusted	No	Yes

* No AuthenticView

** Scripted designs displayed. No internal macro execution or event handling. External events fired.

Authentic Scripts behave in the same way in all Altova products, so no product-specific code or settings are required.

Authentic Script Warning Dialog

If a PXF file, or an XML file linked to an SPS, contains a script and the file is opened or switched to Authentic View, then a warning dialog (*screenshot below*) pops up.

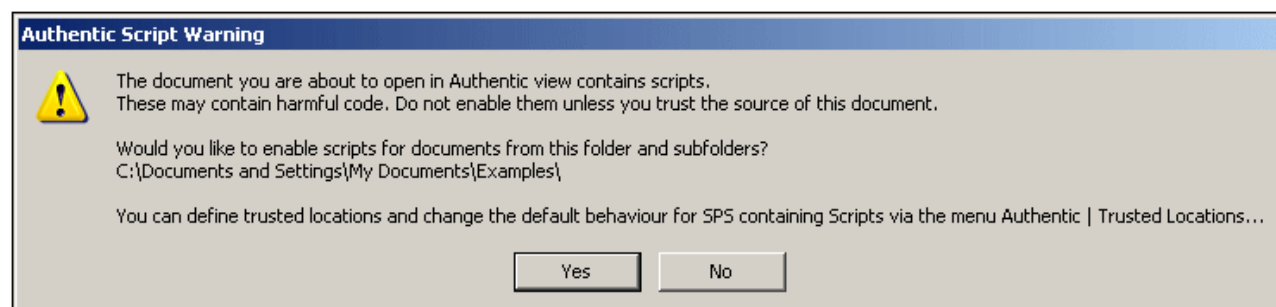

You can choose one of the following options:

- Click **Yes**, to add the folder containing the file to the Trusted Locations list for Authentic scripts. Subsequently, all files in the trusted folder will be opened in Authentic View without this warning dialog being displayed first. The Trusted Locations list can be accessed via the menu command [Authentic | Trusted Locations](#)⁹³⁰, and modified.
- Click **No** to not add the folder containing the file to the Trusted Locations list. The file will be displayed in Authentic View with scripts disabled. The Authentic Script Warning dialog will appear each time this file is opened in Authentic View. To add the file's folder to the Trusted Locations list subsequently, open the Trusted locations dialog via the menu command [Authentic | Trusted Locations](#)⁹³⁰, and add the folder or modify as required.

For a description of the Trusted Locations dialog, see the description of the [Authentic | Trusted Locations](#)⁹³⁰ menu command in the User Reference.

Note: When XMLSpy is accessed via its COM interface (see [Programmers' Reference](#)¹⁰⁹⁰ to see how this can be done), **the security check is not done** and the **Authentic Script Warning dialog is not displayed**.

How Authentic Scripting works

The designer of the SPS design can use Authentic Scripting in two ways to make Authentic documents interactive:

- By assigning scripts for user-defined actions (macros) to design elements, toolbar buttons, and context menu items.
- By adding to the design event handlers that react to Authentic View events.

All the scripting that is required for making Authentic documents interactive is done within the StyleVision GUI (Enterprise and Professional editions). Forms, macros and event handlers are created within the Scripting Editor interface of StyleVision and these scripts are saved with the SPS. Then, in the Design View of StyleVision, the saved scripts are assigned to design elements, toolbar buttons, and context menus. When an XML document based on the SPS is opened in an Altova product that supports Authentic Scripting (see *table above*), the document will have the additional flexibility and interactivity that has been created for it.

Documentation for Authentic Scripting

The documentation for Authentic Scripting is available in the documentation of StyleVision. It can be viewed online via the [Product Documentation page](#) of the [Altova website](#).

12 HTML and CSS

XMLSpy provides intelligent editing features for [HTML](#)⁵⁰⁰ and [CSS](#)⁵⁰², documents. Both types of documents can be edited in [Text View](#)¹³⁰, and the active HTML document can be previewed in Browser View.

The intelligent editing features of each type of document is described separately in the sub-sections of this section: [HTML](#)⁵⁰⁰ and [CSS](#)⁵⁰².

12.1 HTML

HTML documents can be edited in Text View, and the edited page can then be viewed immediately in Browser View. Text View provides a number of useful HTML editing features. These are described in detail in [Text View](#)¹³⁰, but the main features, as well as HTML-specific options, are listed below.

Support level

XMLSpy supports HTML 4.0 and HTML 5.0. Entry-helper and intelligent editing are available for the respective HTML versions. These features are described below.

Entry helpers

Elements, Attributes and Entities entry helpers are available when an HTML document is active. The entry helpers are context-sensitive; the items displayed in the entry helpers are those available at the current cursor location. Use the HTML entry helpers as described in [Text View](#)¹⁴².

Auto-completion

As you type markup text into your HTML document, XMLSpy provides Auto-completion help. A pop-up containing a list of all nodes available at the cursor insertion point is displayed. As you type, the selection jumps to the first closest match in the list (see *screenshot below*). Click the selected item to insert it at the cursor insertion point.

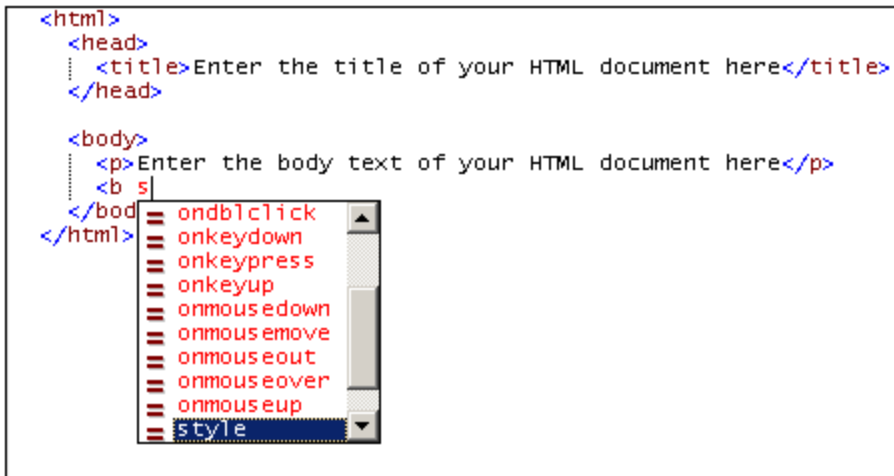

Auto-completion for elements appears when the left bracket of node tags is entered. When the start tag of an element node is entered in the document, the end tag is automatically inserted as well. This ensures well-formedness.

Auto-completion for attributes appears when a space is entered after the element name in a start tag. When you click an attribute name in the Auto-completion pop-up, the attribute is entered with quotes characters and the cursor positioned between the quotes.

The Entities entry helper contains character entities from the HTML 4.0 and HTML 5.0 entity sets, [Latin-1](#), [special characters](#), and [symbols](#).

HTML Info window

The HTML Info window (*screenshot below*) lists applications that can be used to quickly access the active HTML file. For example, if an HTML file is active in XMLSpy, double-clicking the Mozilla Firefox item in the HTML Info Window starts an instance of Mozilla Firefox and loads the active HTML document in it.

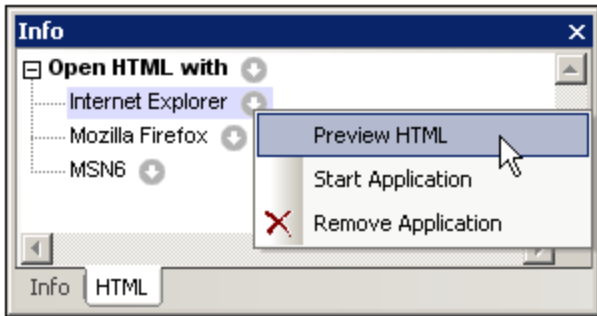

Note the following usage points:

- The icon to the right of the *Open HTML With* item enables applications to be added to the *Open HTML With* list. All the browsers installed on the system, or any other application (such as a text editor), can be added via the menu commands accessed via the *Open HTML With* icon. The associated applications would typically be browser or editor applications.
- After an application has been added to the *Open HTML With* list (except when added with the **Add Installed Browsers** command), its name in the *Open HTML With* list can be changed by selecting it, pressing **F2**, and editing the name.
- The icons to the right of each application listed in the *Open HTML With* list each opens a menu containing commands to: (i) open the application; (ii) open the application and load the linked HTML file; (iii) remove the application from the list. Double-clicking an application name opens the linked HTML file in that application.
- Applications added to or removed from the *Open HTML With* list are also added to or removed from the CSS Info window.

Assigning a DTD

For XHTML documents, a DTD or XML Schema can be assigned via the **DTD/Schema** menu, which enables you to browse for the required DTD or XML Schema file. An XHTML document can be [edited exactly like an XML document](#)²⁸⁷.

Browser View commands

Browser View commands are available in the **Browser** menu.

12.2 CSS

CSS documents can be edited using Text View's intelligent editing features. These features, as they apply to the editing of CSS documents, are listed below.

Syntax coloring

A CSS rule consists of a selector, one or more properties, and the values of those properties. These three components may be further sub-divided into more specific categories; for example, a selector may be a class, pseudo-class, ID, element, or attribute. Additionally, a CSS document can contain other items than rules: for example, comments. In Text View, each such category of items can be displayed in a different color (*screenshot below*) according to settings you make in the Options dialog (*see below*).

```
.header
{
  font-family: "Arial", sans-serif;
  font-weight: bold;
  color: red;
}
```

You can set the colors of the various CSS components in the Fonts and Colors section of the Options dialog (*screenshot below*). In the combo box at top left, select CSS, and then select the required color (in the Styles pane) for each CSS item.

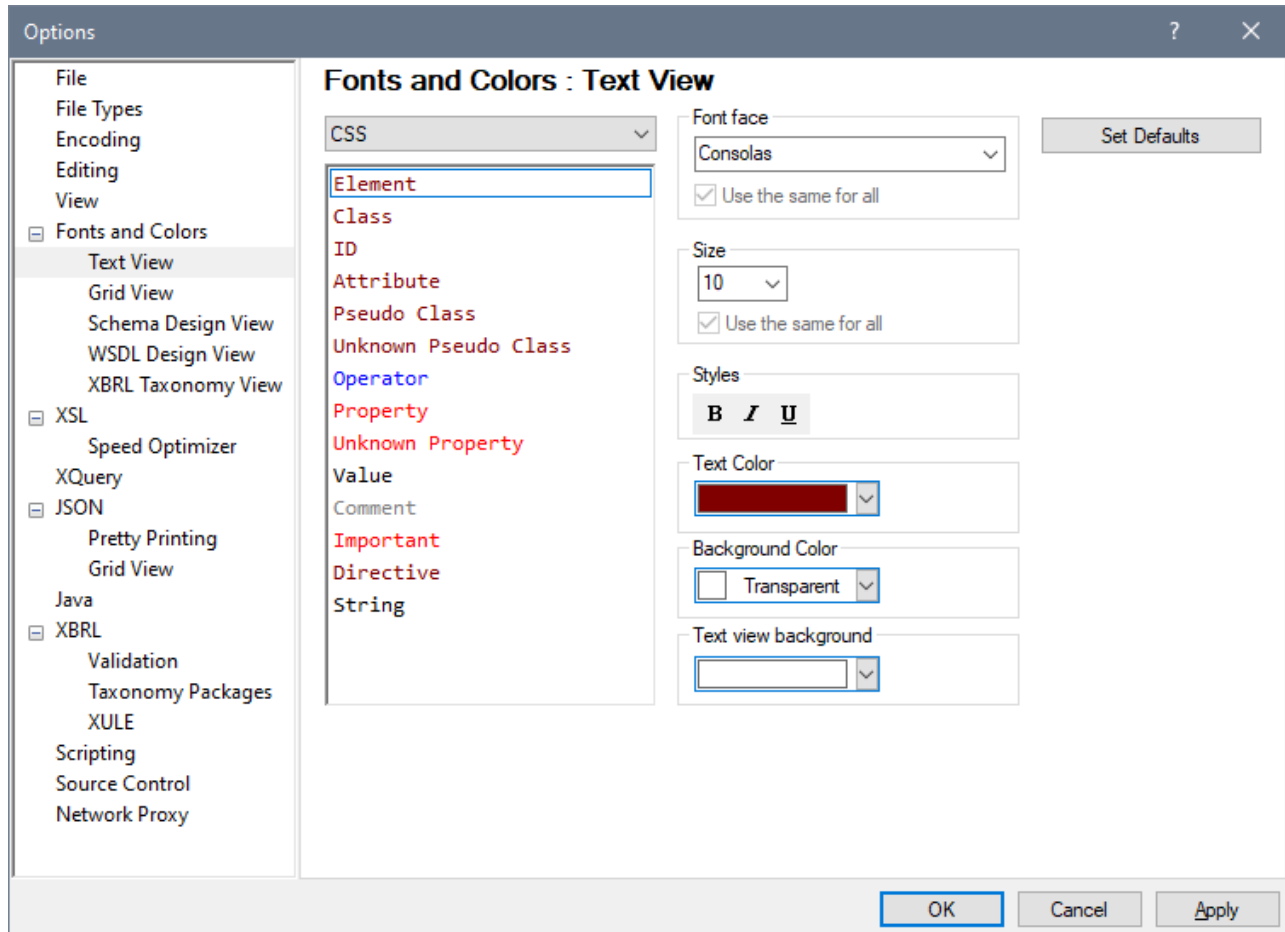

Source folding

Source folding refers to the ability to expand and collapse each CSS rule, which is indicated in the source folding margin by a +/- sign. The margin can be toggled on and off in the [Text View Settings dialog](#)⁹⁹⁵. When a rule is collapsed, this is visually indicated by an ellipsis. If the mouse cursor is placed over an ellipsis, the content of the collapsed rule is displayed in a popup. If the content is too large for a popup, this is indicated by an ellipsis at the bottom of the popup.

The **Toggle All Folds** icon  in the Text toolbar toggles **all** rules to their expanded forms or collapses all rules to the top-level document element.

Note: that the pair of curly braces that delimit a rule (*screenshot above*) turns bold when the cursor is placed either before or after one of the curly braces. This indicates clearly where the definition of a particular rule starts and ends.



CSS outline

The CSS Outline entry helper (*screenshots below*) provides an outline of the document in terms of its selectors. Clicking a selector in the CSS Outline highlights it in the document. In the screenshot at left below, the selectors are unsorted and are listed in the order in which they appear in the document. In the screenshot at right, the Alphabetical Sorting feature has been toggled on (using the toolbar icon), and the selectors are sorted alphabetically.

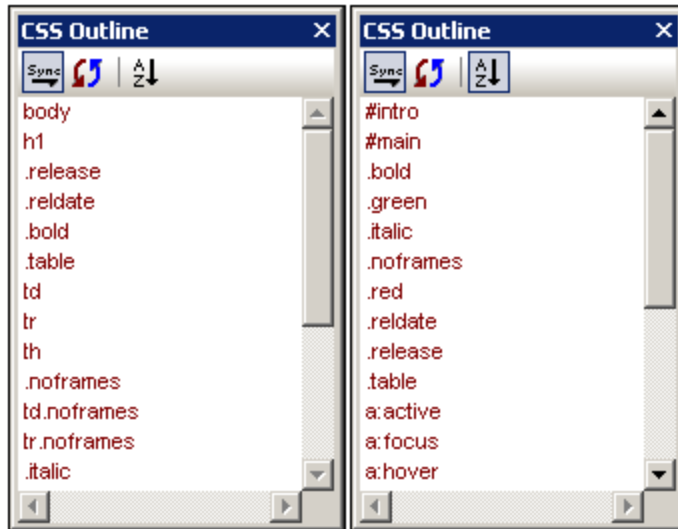
You should note the following points: (i) For evaluating the alphabetical order of selectors, all parts of the selector are considered, including the period, hash, and colon characters; (ii) If the CSS document contains several selectors grouped together to define a single rule (e.g. `h4, h5, h6 { ... }`), then each selector in the group is listed separately.



The icons in the toolbar of the CSS Outline entry helper, from left to right, do the following:

	Toggles automatic synchronization (with the document) on and off. When auto-synchronization is switched on, selectors are entered in the entry helper even as you type them into the document.
	Synchronizes the entry helper with the current state of the document.
	Toggles alphabetical sorting on and off. When off, the selectors are listed in the order in which they appear in the document. When sorted alphabetically, ID selectors appear first because they are prefaced by a hash (e.g. <code>#intro</code>).

Properties entry helper

The Properties entry helper (*screenshot below*) provides a list of all CSS properties, arranged alphabetically. A property can be inserted at the cursor insertion point by double-clicking the property.

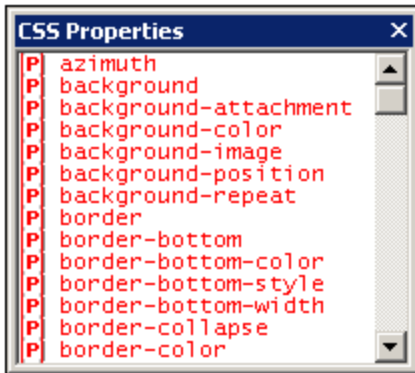

Auto-completion of properties and tooltips for properties

As you start to type the name of a property, XMLSpy prompts you with a list of properties that begin with the letters you have typed (*screenshot below*). Alternatively, you can place the cursor anywhere inside a property name and then press **Ctrl+Space** to pop up the list of CSS properties.

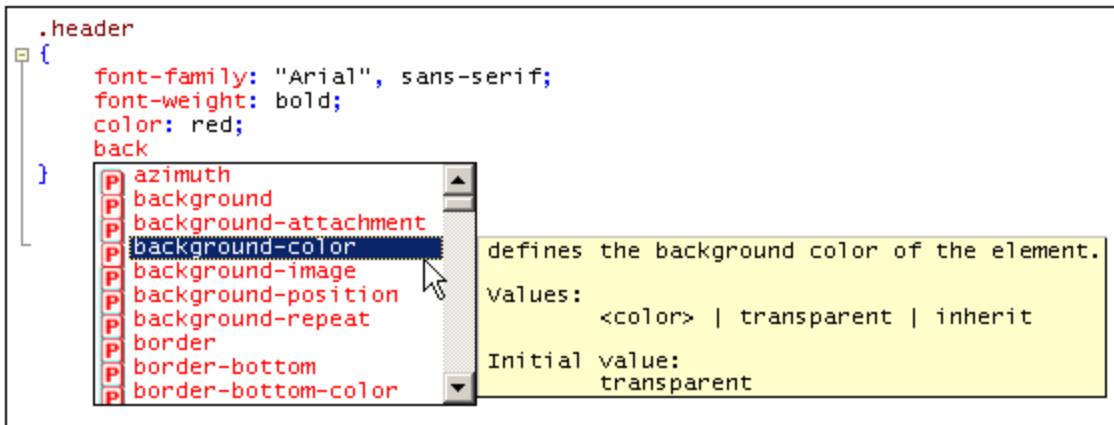

You can view a tooltip containing the definition of a property and its possible values by scrolling down the list or navigating the list with the Up and Down keys of your keyboard. The tooltip for the highlighted property is displayed. To insert a property, either press **Enter** when it is selected, or click it.

CSS Info window

When a CSS file is active, the CSS Info window (*screenshot below*) is enabled. The CSS Info window provides the following functionality:

- It enables you to switch between CSS 2.1 and CSS 3.0. The entry helpers and intelligent editing features of the GUI will be switched according to the CSS version selected in the toolbar of the Info window.
- It enables the CSS file to be linked to an HTML file. This functionality enables you to modify the CSS document and view the effect of changes immediately. Additionally, the linked HTML file can be opened in multiple browsers via the CSS Info window, thus enabling changes in the CSS document to be viewed in multiple browsers.

- The CSS Info window lists the imported CSS stylesheets, thus giving you an overview of the import structure of the active CSS stylesheet.

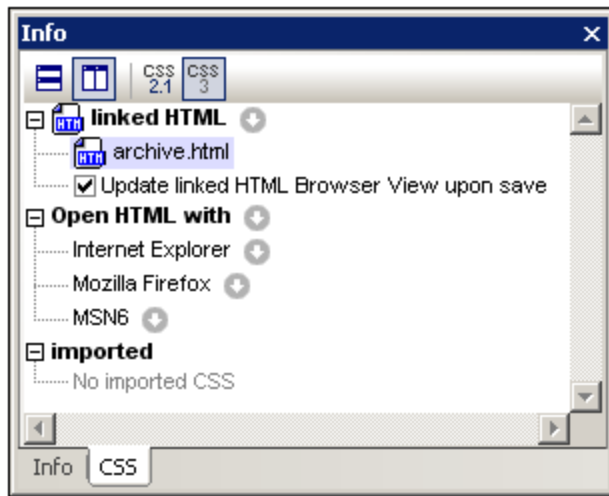

Note the following usage points:

- The toolbar of the Info window contains icons for CSS 2.1 and CSS 3.0. Select the version you want in order to switch entry helpers and intelligent editing features to the selected CSS version.
- Only one HTML file can be linked to the active CSS document. Do this by clicking the icon to the right of the *Linked HTML* item, then selecting the command **Set Link to HTML** and browsing for the required HTML file. The linked HTML file will be listed under the *Linked HTML* item in the Info window (see screenshot above). Creating this link does not modify the CSS document or the HTML document in any way. The link serves to set up an HTML file to which the active CSS document can be applied for testing.
- Double-clicking the Linked HTML file listing opens the HTML file in XMLSpy.
- The toolbar icons enable you to horizontally and vertically tile the CSS document and the HTML file.
- When changes to the CSS document are saved, the HTML file that is open in XMLSpy can be automatically updated. To enable these automatic updates, check the *Update Linked HTML Browser* check box. Note that these updates will only occur if the HTML file contains a reference to the CSS document being edited.
- To change the linked HTML file, select another HTML file via the **Set Link to HTML** command.
- To remove the link to the HTML file, click the icon to the right of the *Linked HTML* item and select the command **Remove Link**.
- The icon to the right of the *Open HTML With* item enables applications to be added to the *Open HTML With* list. All the browsers installed on the system, or any other application (such as a text editor), can be added via the menu commands accessed via the *Open HTML With* icon. The associated applications would typically be browser or editor applications.
- After an application has been added to the *Open HTML With* list (except when added with the **Add Installed Browsers** command), its name in the *Open HTML With* list can be changed by selecting it, pressing **F2**, and editing the name.
- The icons to the right of each application listed in the *Open HTML With* list each opens a menu containing commands to: (i) open the application; (ii) open the application and load the linked HTML file; (iii) remove the application from the list. Double-clicking an application name opens the linked HTML file in that application.
- Applications added to or removed from the *Open HTML With* list are also added to or removed from the HTML Info window.
- The *Imported* item displays a list of the CSS files imported by the active CSS document.

13 JSON, JSON Schema

JSON (*JavaScript Object Notation*) is a lightweight data storage and interchange format that uses JavaScript syntax, and, like XML, is a human-readable, text-only format. Since JSON text can be read and used by any programming language, it has come to be used widely as a data exchange format, especially on the web.

As part of its IDE functionality, XMLSpy provides support for the editing and validation of [JSON data documents \(instance documents\)](#)⁵⁰⁹ and for the creation of syntactically and semantically correct [JSON Schema](#)⁵¹² documents.

JSON5

[JSON5](#) is an extension of JSON that adds some ECMAScript 5 extensions (see [json5.org](#) for more information). JSON5 is a strict subset of JavaScript, adds no new data types to existing JSON types, and works with all existing JSON content.

All XMLSpy functionality that is available for JSON instance documents is also available for JSON5 instance documents. However, note the following major differences between JSON5 and JSON, and in the way XMLSpy handles the two formats:

- JSON5 is not an official successor to JSON. It therefore uses its own file extension: `json5`.
- By default, XMLSpy recognizes files with the `.json` file extension as JSON instance documents, and those with the `.json5` file extension as JSON5 instance documents.
- JSON5 instance documents can be validated against JSON schemas.

In this documentation, the term *JSON instances* refers to both JSON and JSON5 instance documents unless otherwise indicated. Also see the section [Differences between JSON5 and JSON](#)⁵¹¹.

JSON and JSON Schema in XMLSpy

Both document types—JSON instance and JSON schema—are written in JSON format, and must adhere to JSON rules of well-formedness and validity. Both types of document (instance and schema) typically have the `.json` file extension. JSON instances can be edited in [Text View](#)⁵¹⁵ and [Grid View](#)⁵²⁰, and JSON schema documents can be edited in those two views as well as in [JSON Schema View](#)⁵²³, which is a graphical schema editor.

XMLSpy provides the following support for working with JSON instance and JSON schema documents:

- In [Text View](#)⁵¹⁵, syntax coloring and syntax checks; auto-completion in JSON schemas and in instance documents if these have schema associations, folding margins; and structural markings. All of these features ease and speed up the editing of valid JSON instance and JSON schema documents. [Text View](#)⁵¹⁵ provides validation of both instance and schema documents.
- In [Grid View](#)⁵²⁰, a tabular grid structure that helps to better visualize document structure. You can edit directly in [Grid View](#)⁵²⁰. You can also switch between [Text View](#)⁵¹⁵ and [Grid View](#)⁵²⁰ to suit your editing needs. [Grid View](#)⁵²⁰ provides validation of both instance and schema documents.
- JSON instance document validation in [Text View](#)⁵¹⁵ and [Grid View](#)⁵²⁰. The validation is carried out against a JSON schema that is assigned in the [Info Window](#)⁵⁶¹.
- [JSON Schema View](#)⁵²³ displays JSON schemas in a graphical layout. This enables the use of drag-and-drop functionality (in addition to text entry) for the quick creation of JSON schemas. Entry helpers within the view provide editing input. Additionally, the schema is continuously checked for validity, and errors are flagged.

JSON instances: opening existing instance documents and creating new instance documents

- In the [Options | File types](#)¹⁰⁴³ section, you can set the default view ([Text View](#)⁵¹⁵ or [Grid View](#)⁵²⁰) for opening JSON/JSON5 instance documents. Existing JSON/JSON5 documents will be opened in the default starting view you select. You can switch between [Text View](#)⁵¹⁵ and [Grid View](#)⁵²⁰ at any time.
- To create a new JSON or JSON5 instance document, click **File | New**, and select, respectively, `json: JavaScript Object Notation` or `json5: JSON with ECMAScript 5 extensions`. You will be prompted to optionally choose a JSON schema file for the new instance file. If you assign a schema, the assignment will be entered in the [Info Window](#)⁵⁶¹. The new instance document will be opened in [Text View](#)⁵¹⁵ or [Grid View](#)⁵²⁰, depending on the settings in the [Options | File types](#)¹⁰⁴³ tab.

JSON schemas: opening existing schemas and creating new schemas

- An existing JSON schema document opens in [JSON Schema View](#)⁵²³. You can switch to [Text View](#)⁵¹⁵ or [Grid View](#)⁵²⁰ at any time.
- To create a new JSON schema document, click **File | New**, and select `json: JSON Schema`. The new JSON schema document will be opened in [JSON Schema View](#)⁵²³, with the `$schema` keyword at the start of the document. You can switch to [Text View](#)⁵¹⁵ or [Grid View](#)⁵²⁰ at any time.

All these views ([Text](#)⁵¹⁵, [Grid](#)⁵²⁰, and [JSON Schema](#)⁵²³) are described in the sub-sections of this section.

In this section

This section is organized into the following topics:

- [JSON Data](#)⁵⁰⁹ explains the basics of JSON documents
- [JSON Schema](#)⁵¹² describes what a JSON schema is and how it works
- [JSON Lines and JSON Comments](#)⁵¹⁴ provides information about two additional JSON specifications supported by XMLSpy
- [JSON Documents in Text View](#)⁵¹⁵ shows you how to work with the JSON-relevant features of Text View
- [JSON Documents in Grid View](#)⁵²⁰ describes how to edit JSON documents in Grid View
- [JSON Schema View](#)⁵²³ explains the JSON-schema-editing features of the view and how you can use it when creating your JSON projects
- [Validating JSON Data/Documents](#)⁵⁶¹ describes how to assign a JSON schema to a JSON document and how to validate JSON documents
- [Inserting JSON Fragments](#)⁵⁶³ describes how to quickly insert JSON text fragments into your JSON document from external sources
- [JSON Transformations with XSLT/XQuery](#)⁵⁶⁵ describes how JSON documents can be queried with XPath/XQuery 3.1
- [XQuery Expressions for JSON](#)⁵⁶⁷ gives a broad introduction about using XQuery with JSON documents
- [Generating JSON Schema from a JSON Instance](#)⁵⁶⁹ describes the functionality to generate a schema from an instance
- [Generating a JSON Instance from a JSON Schema](#)⁵⁷² describes how to generate an instance from a schema
- [Converting between JSON and XML](#)⁵⁷³ describes how to convert between JSON and XML in XMLSpy

13.1 JSON Data

This section contains a brief description of how JSON data is structured. JSON data is typically stored in a JSON (instance) document but can also be stored as a JSON data fragment in a document of another type. A JSON data fragment or document is a JSON data structure, which is broadly defined as set out below.

XMLSpy additionally supports **JSON5**, which is an extension of JSON that adds some minimal ECMScript 5 extensions. See json5.org for more information.

JSON objects and arrays

A JSON document (saved typically with the file extension `.json`) is built on the following core data structures:

Object

An **object** is delimited by curly braces, and is an unordered collection of zero or more `key:value` pairs. These `key:value` pairs are the **properties of the object**. The key must always be a string and must therefore always be enclosed in quotes. The key (also called the name of the property) is separated from its value by a colon. A property value can be of any JSON datatype ([see list below](#)⁵¹⁰). A property is separated from the next by a comma. The listing below is an example of an object with three properties (all of which have atomic-type values):

```
{
  "emailtype": "home",
  "emailaddress": "contact01.home@altova.com",
  "citycode": 22
}
```

Array

An **array** is delimited by square brackets, and is a comma-separated ordered list of zero or more **items**. These items can be of any JSON datatype ([see list below](#)⁵¹⁰).

▣ Example of an array containing two objects

The array below consists of two objects (each enclosed in curly braces). The array itself is indicated with square brackets.

```
[
  {
    "emailtype": "home",
    "emailaddress": "contact01.office@altova.com",
    "citycode": 22
  },
  {
    "emailtype": "office",
    "emailaddress": "contact01.office@altova.com",
    "citycode": 22
  }
]
```

Example of arrays that are the values of an object's properties

The listing below is of an object with three `key:value` pairs. Each value is an array that contains a **tuple (sequence)**. (A tuple can be considered to be a one-dimensional array.) The three items in each tuple are atomic types.

```
{
  "x": [ 1, 2, "abc" ],
  "y": [ 3, 4, "def" ],
  "z": [ 5, 6, "ghi" ]
}
```

JSON data types

Object property values and array items can be of the following types:

- **string** (must be enclosed in quotes). A string can additionally be specified to have a [format](#), such as a date-time or email format
- **number**: A number with a fractional part; it includes integers
- **integer**: A number with no fractional part; a subset of the `number` type
- **boolean** (`true/false`, not enclosed in quotes)
- **object**: When used within another object, allows data to be nested
- **array**: Provides the ability to build more complex structures than allowed by objects
- **null** (`null`, not enclosed in quotes)

Example of JSON data

Here is an example of a JSON data fragment. Note how the document is structured into objects and arrays. Also note the data type of key values; string values are in quotes, other types are colored green.

```
{
  "first": "Jason",
  "last": "Jones"
  "isManager": true,
  "age": 35,
  "address": {
    "street": "Jason Avenue",
    "city": "Jasonville",
    "state": "JS",
    "postcode": "JS12 ON34"
  },
  "phone": [
    {
      "type": "home",
      "number": "12 3456-7890"
    },
    {
      "type": "office",
      "number": "789 012-34567"
    }
  ]
},
```

```
"children": [],  
"partner": null  
}
```

Some differences between JSON5 and JSON

JSON5 is a strict subset of JavaScript, adds no new JSON data types, and works with all existing JSON content. Some notable differences are listed below:

- JSON5 supports comments. Comments are delimited like this: `// comment //` or `/* comment */`.
- In JSON5, the keys of `key:value` pairs do not need to be enclosed in quotes.
- In JSON5, strings can be written across multiple lines.
- JSON5 documents can be validated against JSON schemas.

13.2 JSON Schema

In the same way that an XML Schema specifies the structure and content of an XML document, a JSON schema specifies how the JSON data in a JSON document is organized. It specifies what data fields are expected and how the values are represented. The JSON Schema specification and more information about JSON Schema is available [here](#).

A JSON schema is itself a JSON object. Lexically, the entire schema is contained within curly braces (see *listing below*), which are the delimiters of JSON objects. The schema is written in JSON syntax and will be saved typically in a file with a `.json` extension. It is indicated as a JSON schema, by the `$schema` keyword, which should be the first keyword of the top-level object. This keyword should have a value that is one of the following:

- Versions to draft-07: `"http://json-schema.org/draft-N/(hyper-)schema#"` , where `N` is the number of the version (04, 06, or 07).
- Versions from draft-2019-09 onwards: `"https://json-schema.org/draft/YYYY-MM/(hyper-)schema"` , where `YYYY` and `MM` are, respectively, the year and month of the draft, for example, 2019-09.

Here is an example of how the `$schema` keyword is used.

```
{
  "$schema": "https://json-schema.org/draft/2020-12/schema",
  ...
}
```

Note: Although the `$schema` keyword can have the value `"http://json-schema.org/schema#"` —which specifies the latest version of the schema—it is best to use a URL that identifies the specific version. For more information, see [JSON Schema Version](#) ⁵²⁴.

In XMLSpy, you can create JSON schemas graphically in JSON Schema View. How to do this is described in the section [JSON Schema View](#) ⁵²³. Besides the schema editing features available in JSON Schema View, the following schema-related features are available:

- Validation with the JSON Validator of XMLSpy: Assign a JSON schema to a JSON instance document, and validate the instance document from within XMLSpy. See [Validating JSON Documents](#) ⁵⁶¹ for information.
- Setting [JSON validation options](#) ¹⁰⁵³.
- [Generating JSON Schema from a JSON Instance](#) ⁵⁶⁹: If a JSON instance document already exists, you can generate a JSON schema from it. You can subsequently edit the schema if you need to.
- [Converting between JSON and XML](#) ⁵⁷³: You can convert between documents of the two formats.

Terminology

Given below are definitions of common JSON schema terms used in the GUI and this documentation.

Term	Definition
Schema	The top-level schema object in a JSON schema document; the schema file.
Object	A JSON type containing zero or more properties.

Property	A key:value ⁵⁰⁹ pair of an object. Its value can be any JSON datatype.
Keyword	The <code>key</code> part of an object's key:value ⁵⁰⁹ pair. It is always a string.
Sub-schema	An object that is a child of an operator or a dependency.
Definition	The complete description of any JSON type. Definitions can be global or local ⁵³⁰ .
Array	A comma-separated ordered list of zero or more <code>items</code> of any JSON datatype.
Atomic types	The <code>string</code> , <code>number</code> , <code>integer</code> , <code>boolean</code> , and <code>null</code> JSON datatypes.
Type selectors	The <code>any</code> and <code>multiple</code> types, which select any and multiple types ⁵⁴⁸ , respectively
Operators	Occurrence selectors that can be added as children of definitions. See <i>the section Operators</i> ⁵⁵⁴ .

JSON data types

Object property values and array items can be of the following types:

- `string` (must be enclosed in quotes). A string can additionally be specified to have a [format](#), such as a `date-time` or `email` format
- `number`: A number with a fractional part; it includes integers
- `integer`: A number with no fractional part; a subset of the `number` type
- `boolean` (`true/false`, not enclosed in quotes)
- `object`: When used within another object, allows data to be nested
- `array`: Provides the ability to build more complex structures than allowed by objects
- `null` (`null`, not enclosed in quotes)

13.3 JSON Lines and JSON Comments

XMLSpy supports JSON Lines (JSONL) and JSON with Comments (JSONC) documents, meaning that validation and intelligent editing of these documents is available to the same extent that it is for other types of JSON documents. This section discusses key features of these types of JSON documents.

JSON Lines

JSON Lines (JSONL) is a format for storing structured data, where each record is separated from the next by a newline; that is, each record is on its own line. As a result, each record can be processed one at a time, which makes the format very useful when processing data such as log files.

Example JSON Lines document

```
["Team", "Played", "Won", "Drew", "Lost", "Points"]
["USA", 2, 1, 1, 0, 4]
["France", 3, 1, 1, 1, 4]
["Germany", 1, 0, 1, 0, 1]
["USA", 1, 0, 0, 1, 0]
```

For more examples, see <http://jsonlines.org/examples/>.

JSON Lines files are recognized as such in XMLSpy if the file has a `.jsonl` extension.

JSON with Comments

JSON documents other than JSON5 documents do not allow comments. The JSON with Comments format (JSONC) has been introduced to allow comments in JSON documents. The following comments are used in JSONC and supported in XMLSpy:

- Single-line comments: Prefixed by `//`. For example: `// My comment`
- Multi-line comments: Delimited by `/*` and `*/`. For example: `/* My comment */`

JSONC files are recognized as such in XMLSpy if the file has a `.jsonc` extension.

Note: Comments are also allowed in JSON5 documents. Comments in other types of JSON files (besides JSONC and JSON5) could cause errors during processing.

13.4 JSON Text View

Altova website: [JSON Editor](#)

JSON schemas and JSON/JSON5 instance documents can be edited using the intelligent editing features of Text View. These features include: [folding margins](#)⁵¹⁵, [structural marking](#)⁵¹⁶, [syntax coloring](#)⁵¹⁶, [syntax checking](#)⁵¹⁷, [saving Base64-encoded image strings in their image formats](#)⁵¹⁹, and [auto-completion](#)⁵¹⁸. XMLSpy also provides [conversion between JSON/JSON5 and XML](#)⁵⁷³ in both directions, and enables you to [generate a JSON schema from a JSON/JSON5 instance](#)⁵⁶⁹.

Folding margins

Source folding is enabled on JSON keywords and definitions, and refers to the ability to expand and collapse these nodes. Such nodes are indicated in the source folding margin by a +/- sign (see *screenshot below*). The margin can be toggled on and off in the [Text View Settings dialog](#)⁹⁹⁵. When a node is collapsed, this is visually indicated by an ellipsis (see *screenshot below*). If the mouse cursor is placed over an ellipsis, the content of the collapsed node is displayed in a popup (see *screenshot*). If the content is too large for a popup, this is indicated by an ellipsis at the bottom of the popup.

```

1  {
2  "Artists": [
3  {
4    "Name": "Queen",
5    "Albums": [
6    {
7      "Name": "A Night at the Opera",
8      "Genre": [
9        "Rock"
10     ],
11     "ReleaseDate": "1975-11-21",
12     "Label": "EMI / Hollywood Records",
13     "Tracks": [
14     {
15       "Title": "Death on Two Legs",
16       "Duration": "03:43",
17       "Writer": "Freddie Mercury"
18     },
19     {
20       "Title": "I'm in Love with My Car",
21       "Duration": "03:05",
22       "Writer": "Roger Taylor"
23     }
24     ]
25   }
26   ]
27 }

```

The **Toggle All Folds** icon  in the Text toolbar toggles **all** nodes to their expanded forms or collapses all nodes to the top-level document element.

The following options are available when clicking on the node's +/- icon:

Click [-]	Collapses the node.
Click [+]	Expands the node so that descendant nodes are shown expanded or collapsed according to how they were before the node was collapsed.

Shift+Click [-]	Collapses all descendant nodes, but leaves the node that was clicked in its expanded form.
Ctrl+Click [+]	Expand the clicked node as well as all its descendant nodes.

Structural marking

The pair of curly braces or square brackets that delimit a JSON object or array, respectively, (see *screenshot below*) turns bold when the cursor is placed either before or after one of the braces or brackets. This indicates where the definition of a particular element starts and ends.

```

"Department": [ { "Name": "Administration",
  "Person": [ { "First": "Vernon",
    "Last": "Callaby",
    "Title": "Office Manager",
    "PhoneExt": 582,
    "EMail": "v.callaby@nanonull.com",
    "Shares": 1500,
    "LeaveTotal": 25,
    "LeaveUsed": 4,
    "LeaveLeft": 21},

```

Syntax coloring

A JSON document (JSON instance/schema), as well as a JSON5 document, is each made up of object strings, value strings, operators, numbers and keywords. In Text View, each category of items can be displayed in a different color (see *screenshot above*) according to settings you make in the [Options dialog](#)¹⁰⁴⁰ (*screenshot below*). You can set the colors of the various JSON components in the Text Fonts section of the Options dialog (*screenshot below*). In the combo box at top left, select *JSON*, and then select the required color (in the Styles pane) for each JSON item.

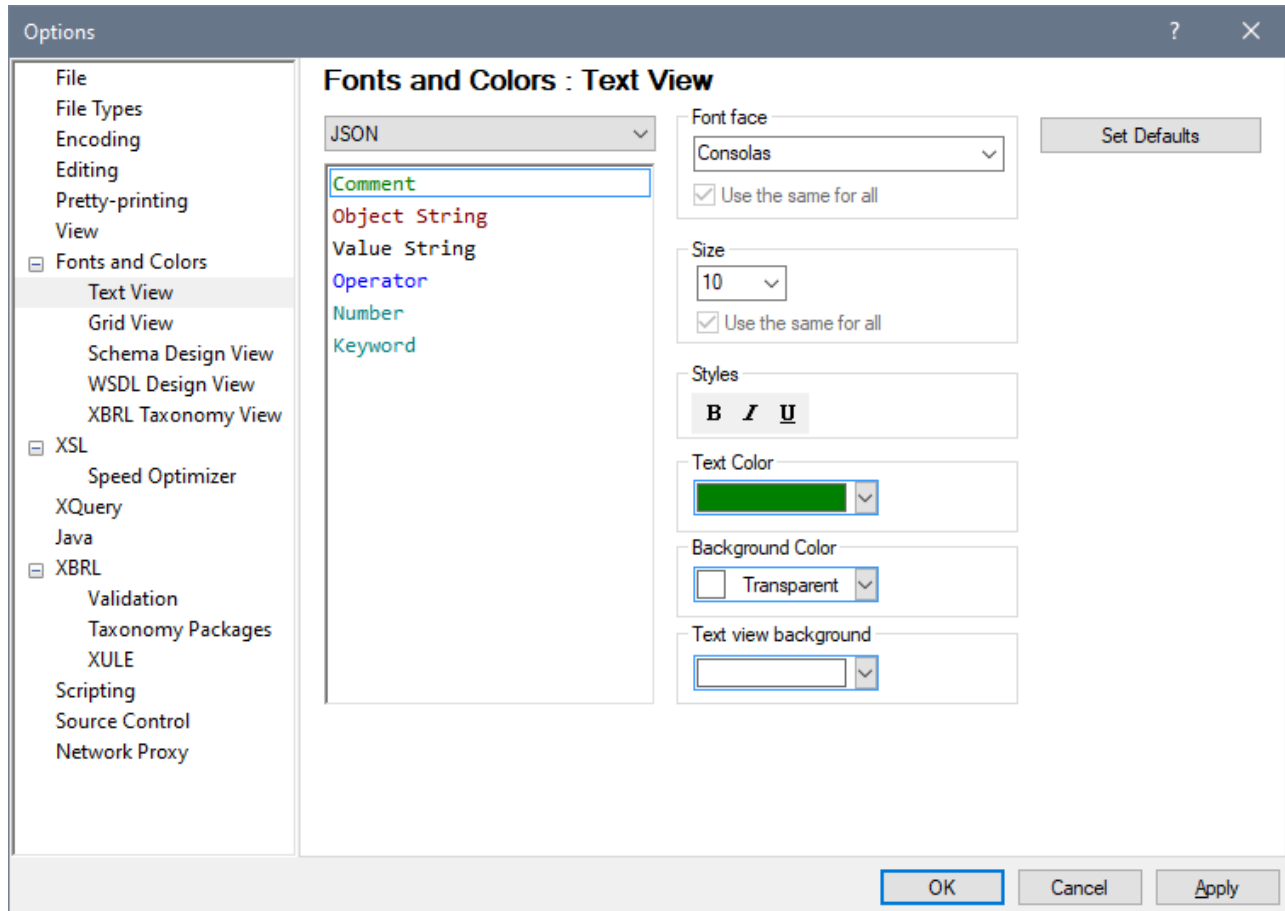

Note: JSON5 syntax—but not JSON syntax—allows for comments. Comments in JSON5 are delimited like this: `// comment //` or `/* comment */`.

Syntax checking

The syntax of a JSON document (JSON instance/schema) can be checked by selecting the command **XML | Check Well-Formedness (F7)**. The results of the well-formed check are displayed in the Messages window (screenshot below).

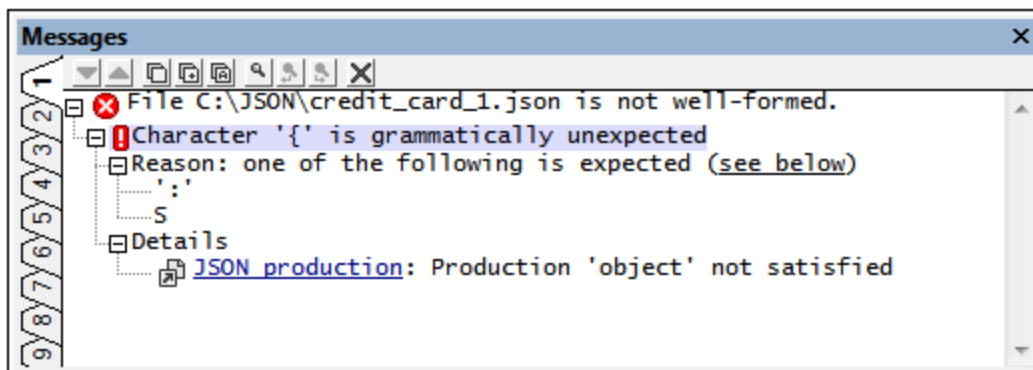

The error message in the screenshot above points out an error in the document: An opening curly brace occurs at a location where a colon is expected.

Auto-completion

Auto-completion is enabled when the JSON document (JSON instance/schema) being edited is associated with a schema.

- If the document is a JSON schema, then auto-completion is based on the schema version indicated by the `$schema` ⁵¹² keyword. For more information, see also [JSON Schema Version](#) ⁵²⁴.
- If the document is a JSON/JSON5 instance, then a [JSON schema must be assigned to the instance](#) ⁵⁶¹ in order for auto-completion to be enabled.

Auto-completion provides you with the available entry options at the cursor location. It does this (i) via pop-ups in the main window, and (ii) via the entry helpers (see *screenshot below*). The pop-ups and entry helpers each display a list of entries that are valid at that cursor location. To move through the entries in the pop-up list, use the arrow keys. If the schema contains a description of the entry (in the entry's `description` keyword in the schema), then the description is displayed next to the highlighted pop-up entry. Select an entry from the pop-up window or double-click an entry in the entry helper to insert it.

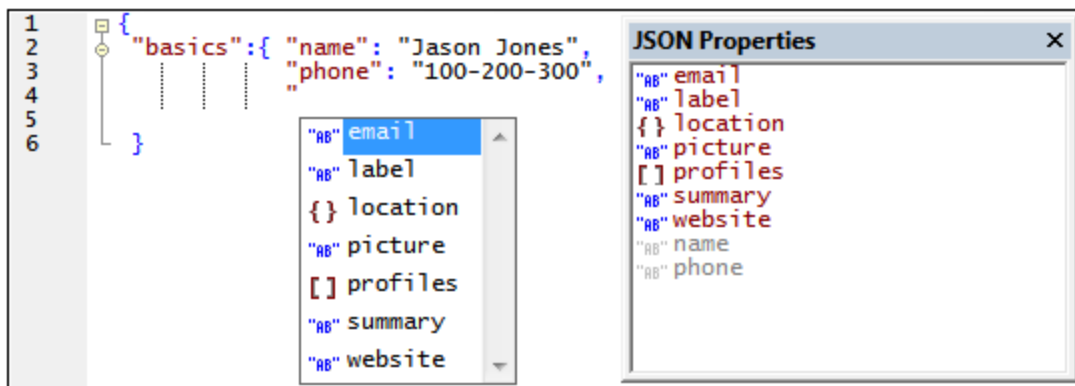

In the instance document shown in the screenshot above, the pop-up and JSON Properties entry helper are shown when the cursor is located after the quotes that indicate the start of a property's name. The entry helper displays all the properties allowed at that point; the properties that have already been entered are shown grayed out and disabled. The pop-up displays only the properties that are allowed at that point.

There are two other entry helpers: JSON Values and JSON Entities (*screenshot below*). These show, respectively, the allowed values of `key:value` pairs and entities for escaping characters in JSON strings. The JSON Values entry helper in the screenshot below shows the values allowed for the `type` keyword while editing a JSON schema. The last entry in the JSON Entities entry helper, `\u00FF`, is a placeholder that stands for a Unicode character. Replace the part highlighted in blue with the code of the Unicode character you want.

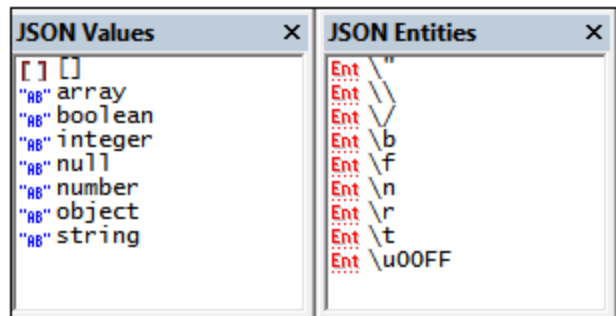

Other context-sensitive auto-completion entries or hints include the following, when these are specified in the schema: enumerations, descriptions, required occurrences, and default values.

Save a Base64-encoded string as an image

To save a Base64-encoded string in its image format, right-click the encoding text and select the command **Save as Image**. In the dialog that appears, select the location where you want to save the image and enter a name for the image file. The extension of the image file (.png, .gif, .svg, etc) will be auto-detected from the Base64 encoding and will appear in the Save dialog. Click **Save** when done.

This action can also be carried out via the **Edit | Save as Image** menu command.

13.5 JSON Grid View

JSON Grid View enables you to see the structure of the JSON document (JSON instance/schema) and to edit the document more easily. Reading a JSON document in Text View can be difficult because the hierarchy is not easily discernible visually, especially if arrays and objects are nested within other arrays and objects at multiple levels. For example, compare the JSON text listed below (as it would appear in Text View) and its representation in Grid View (as shown in the screenshot further below).

Note: Avro support is available in the **Enterprise Edition only**.

JSON code listing in Text View

```
{
  "web-app": {
    "servlet": [
      {
        "servlet-name": "altovaCDS",
        "servlet-class": "org.altova.cds.CDSServlet",
        "init-param": {
          "configGlossary:installationAt": "Philadelphia, PA",
          "configGlossary:adminEmail": "ksm@pobox.com",
          "configGlossary:poweredBy": "Altova",
          "configGlossary:poweredByIcon": "/images/altova.gif",
          "configGlossary:staticPath": "/content/static",
          "templateProcessorClass": "org.altova.WysiwygTemplate",
          "templateLoaderClass": "org.altova.FilesTemplateLoader",
          "templatePath": "templates",
          "templateOverridePath": "",
          "defaultListTemplate": "listTemplate.htm",
          "defaultFileTemplate": "articleTemplate.htm",
          "useJSP": false,
          "jspListTemplate": "listTemplate.jsp",
          "jspFileTemplate": "articleTemplate.jsp",
          "cachePackageTagsTrack": 200,
          "cachePackageTagsStore": 200,
          "cachePackageTagsRefresh": 60,
          "cacheTemplatesTrack": 100,
          "cacheTemplatesStore": 50,
          "cacheTemplatesRefresh": 15,
          "cachePagesTrack": 200,
          "cachePagesStore": 100,
          "cachePagesRefresh": 10,
          "cachePagesDirtyRead": 10,
          "searchEngineListTemplate": "forSearchEnginesList.htm",
          "searchEngineFileTemplate": "forSearchEngines.htm",
          "searchEngineRobotsDb": "WEB-INF/robots.db",
          "useDataStore": true,
          "dataStoreClass": "org.altova.SqlDataStore",
          "redirectionClass": "org.altova.SqlRedirection",
          "dataStoreName": "altova",
          "dataStoreDriver": "com.microsoft.jdbc.sqlserver.SQLServerDriver",
          "dataStoreUrl": "jdbc:microsoft:sqlserver://LOCALHOST:1433;DatabaseName=goon",
```

```
    "dataStoreUser": "sa",
    "dataStorePassword": "dataStoreTestQuery",
    "dataStoreTestQuery": "SET NOCOUNT ON;select test='test';",
    "dataStoreLogFile": "/usr/local/tomcat/logs/datastore.log",
    "dataStoreInitConns": 10,
    "dataStoreMaxConns": 100,
    "dataStoreConnUsageLimit": 100,
    "dataStoreLogLevel": "debug",
    "maxUrlLength": 500
  }
}, {
  "servlet-name": "altovaEmail",
  "servlet-class": "org.altova.cds.EmailServlet",
  "init-param": {
    "mailHost": "mail1",
    "mailHostOverride": "mail2"
  }
}, {
  "servlet-name": "altovaAdmin",
  "servlet-class": "org.altova.cds.AdminServlet"
}, {
  "servlet-name": "fileServlet",
  "servlet-class": "org.altova.cds.FileServlet"
}, {
  "servlet-name": "altovaTools",
  "servlet-class": "org.altova.cms.AltovaToolsServlet",
  "init-param": {
    "templatePath": "toolstemplates/",
    "log": 1,
    "logLocation": "/usr/local/tomcat/logs/AltovaTools.log",
    "logMaxSize": "",
    "dataLog": 1,
    "dataLogLocation": "/usr/local/tomcat/logs/dataLog.log",
    "dataLogMaxSize": "",
    "removePageCache": "/content/admin/remove?cache=pages&id=",
    "removeTemplateCache": "/content/admin/remove?cache=templates&id=",
    "fileTransferFolder": "/usr/local/tomcat/webapps/content/fileTransferFolder",
    "lookInContext": 1,
    "adminGroupID": 4,
    "betaServer": true
  }
}
],
"servlet-mapping": {
  "altovaCDS": "/",
  "altovaEmail": "/altovautil/aemail/*",
  "altovaAdmin": "/admin/*",
  "fileServlet": "/static/*",
  "altovaTools": "/tools/*"
},
>taglib": {
  "taglib-uri": "altova.tld",
```

```

    "taglib-location": "/WEB-INF/tlds/altova.tld"
  }
}
}

```

While the document structure in Text View (*listing above*) is difficult to discern without a longer, more careful reading, the structure in Grid View (*screenshot below*) is more readily seen at a glance.

	servlet-name	servlet-class	{ } init-param
{ } 1	"RB" altovaCDS	"RB" org.altova.cds.CDSServlet	{ } init-param {"configGlossary:installationAt": "
{ } 2	"RB" altovaEmail	"RB" org.altova.cds.EmailServlet	{ } init-param {"mailHost": "mail1", "mailHostOve
{ } 3	"RB" altovaAdmin	"RB" org.altova.cds.AdminServlet	+
{ } 4	"RB" fileServlet	"RB" org.altova.cds.FileServlet	+
{ } 5	"RB" altovaTools	"RB" org.altova.cms.AltovaToolsSe	{ } init-param {"templatePath": "toolstemplates/

altovaCDS	"RB" /
altovaEmail	"RB" /altovautil/aemail/*
altovaAdmin	"RB" /admin/*
fileServlet	"RB" /static/*
altovaTools	"RB" /tools/*

taglib-uri	"RB" altova.tld
taglib-locati	"RB" /WEB-INF/tlds/altova.tld

Additionally, the structure can be easily modified by adding, deleting, or moving objects in the grid. Entire blocks of text can be reorganized (for example, by sorting them or moving them). Content, too, can be edited easily in Grid View, this being made even easier with the availability of [in-cell commands in individual cells](#) ¹⁵⁶.

Furthermore, if a node is repeated (such as the objects in the `servlet` array shown in the screenshot above), then instead of each object repeating in serial order, they can be displayed in a table format, where the keys of key–value pairs in the objects are displayed as columns of the table and each object is displayed in a numbered row (*see the table in the screenshot above*).

Grid View provides you with other powerful features for displaying your JSON document in graphical form (such as a split view, filters, and charts), as well as editing features such as drag-and-drop and the ability to create formulas that generate new data.

For a full description of Grid View features, see the [Editing Views | Grid View section](#) ¹⁴⁶.

13.6 JSON Schema View

JSON Schema View can be used to view and edit JSON schema documents. The main parts of the JSON Schema View window are:

- A main window that switches between a [Definitions Overview Grid](#)⁵²⁶ and a [Design View](#)⁵³²
- Three [entry helper windows](#)⁵²⁷ (located by default on the right-hand side of the main window): Overview, Details, and Constraints
- A Messages window (located by default below the main window)
- An [Info window](#)⁵⁶¹ (located by default at bottom left of the application window)

The screenshot below shows the main window and the Overview entry helper.

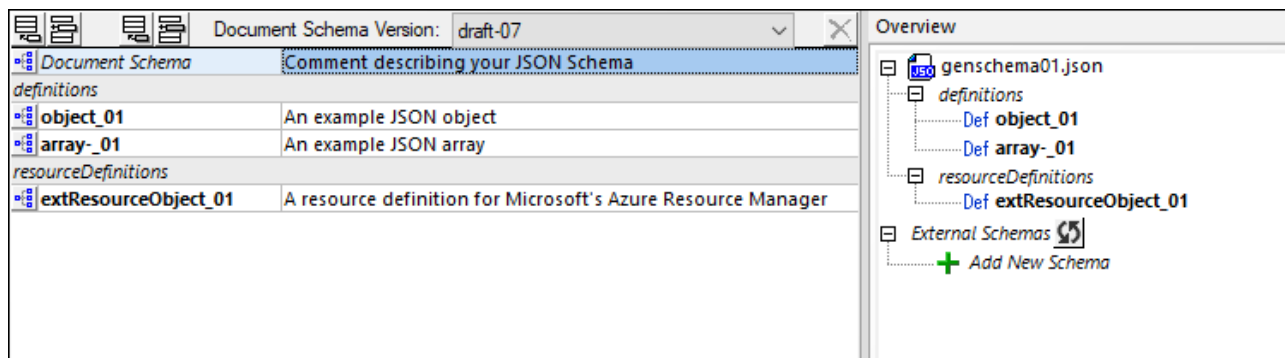

The main window

The main window switches between a [Definitions Overview Grid](#)⁵²⁶ (shown in screenshot above) and a [Design View](#)⁵³² (screenshot below). Definitions Overview Grid shows the current document's main schema (listed as "Document Schema"), plus any definitions that you add to the schema. (A definition is a description of a JSON data structure. In the screenshot above, `object_01` and `array_01` are definitions, of an object and an array, respectively.) Definitions are also listed in the Overview entry helper (see screenshot above).

While Definitions Overview Grid provides a high level view of the JSON schema, it does not show what is within any definition listed in the overview. To view and edit a definition in Design View (screenshot below), click the definition's icon (see screenshot above) or double-click the definition in the Overview entry helper (see screenshot above).

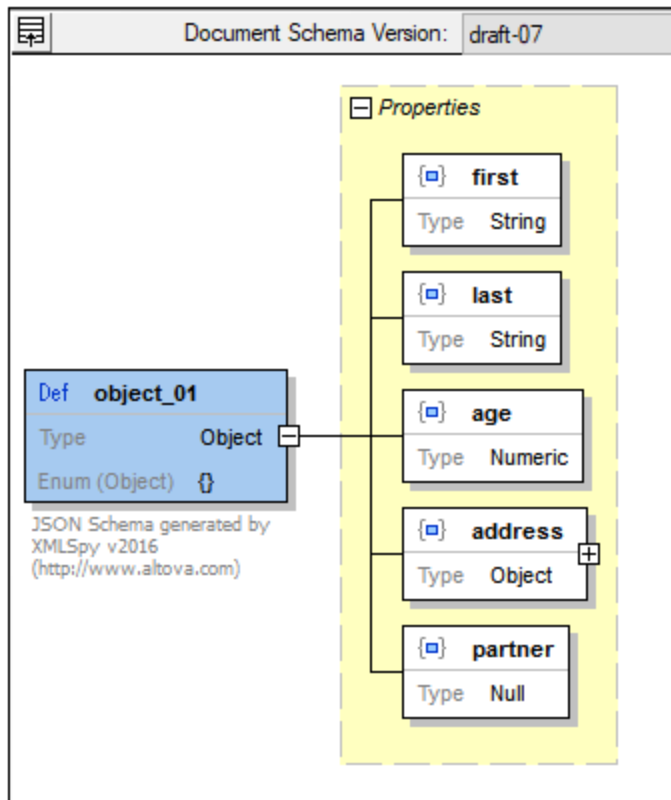

To switch back to Definitions Overview Grid from Design View, click the **Switch to Definitions Grid** icon at the top left of Design View (see *screenshot above*). To configure Design View, click the menu command [Schema Design | Configure View](#)⁵⁵⁷.

The entry helpers

Both modes of Schema View (Definitions Overview Grid and Design View) have three entry helpers: Overview, Details, and Constraints. These entry helpers provide mechanisms for: (i) displaying information about the schema and its definitions, and (ii) entering information and values related to definitions. They are described in detail in the section [Entry Helpers: Overview, Details, Constraints](#)⁵²⁷.

13.6.1 JSON Schema Version

A JSON schema is written in JSON syntax and will be saved typically in a file with a `.json` extension. It is indicated as a JSON schema by the `$schema` keyword, which should be the first keyword of the top-level object and have a value that is the URI of the JSON schema version you want to use. Here are two examples showing how to use the `$schema` keyword:

```
{
  "$schema": "http://json-schema.org/draft-07/schema#",
  ...
}
```



```
{
  "$schema": "http://json-schema.org/schema#",
  ...
}
```

In the first example above, the schema version is explicitly named. Instead of explicitly selecting a version, you can use "http://json-schema.org/schema#", as in the second example above. This indicates that the schema version to be used is the latest version (currently **2020-12 and 2019-09-hyper**).

In JSON Schema View, you can change the version in the combo box in the bar at the top of the main window (see screenshot below).

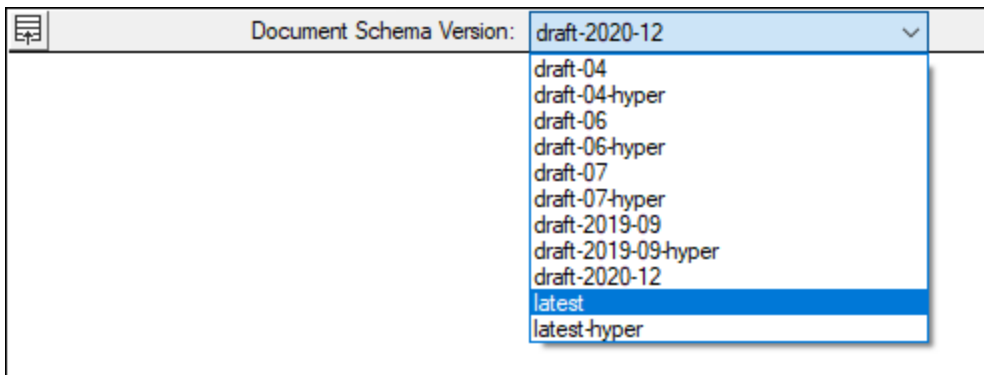

Features of new schema versions that are not defined in an older version

If you use a feature of a newer schema version and then switch to an older version that does not support this feature, then the following happens:

- A message appears asking whether you wish to remove/convert the feature or keep the feature
- If kept, the new feature's corresponding component or detail is shown in an orange text color. For example, if a value has been set for the `const` keyword (new in `draft-06`) and you switch the schema version to `draft-04`, then the value of the `const` keyword is displayed in orange.

JSON Schema versions

For information about the JSON Schema specifications, especially about additional features with each version, see the links below:

JSON Schema specification: <http://json-schema.org/specification.html>

Draft-06 release notes: <http://json-schema.org/draft-06/json-schema-release-notes.html>

Draft-07 release notes: <http://json-schema.org/draft-07/json-schema-release-notes.html>

Draft 2019-09 (formerly Draft-08): <http://json-schema.org/specification-links.html#2019-09-formerly-known-as-draft-8>

Draft 2020-12: <http://json-schema.org/specification-links.html#2020-12>

Additionally, the following Hyper Schemas are available: `draft-04-hyper`, `draft-06-hyper`, `draft-07-hyper`, `2019-09-hyper`.

Links to the core schemas and hyper schemas are available here: <http://json-schema.org/specification-links.html>.

13.6.2 Adding Global Definitions

The **Definitions Overview Grid** ⁵²³ in the main window (*screenshot below*) displays a list of the schema's global definitions. These global definitions are: (i) the main *Document Schema* definition, (ii) *definitions* (or *\$defs* in later schemas) of global JSON types, such as objects, arrays, strings, etc, that are JSON Schema types; (iii) definitions of external or custom-defined JSON types; currently only definitions that occur within a container named `resourceDefinitions` are available; this is the container used by Microsoft's Azure Resource Manager for JSON definitions. Add a new *resourceDefinitions* section to the schema document via the **Append Definitions Section** or **Insert Definitions Section** icon in the grid's toolbar (*see screenshot below*).

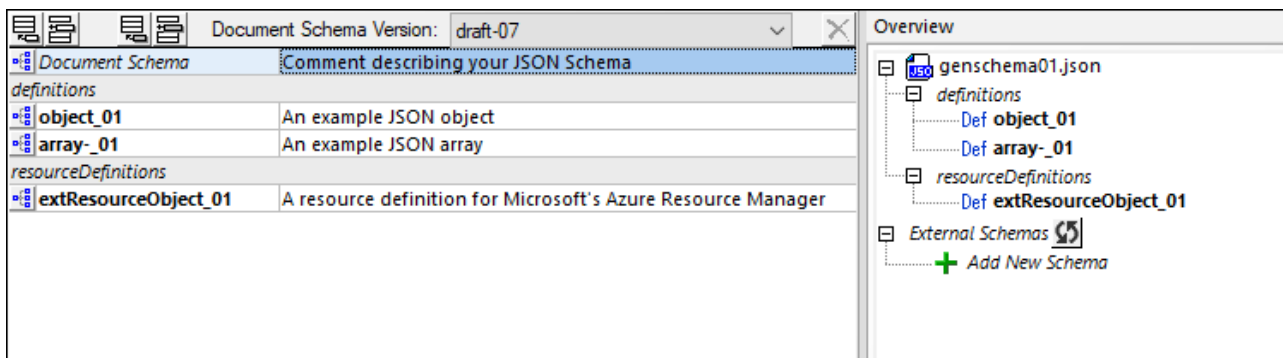

Defining a **JSON type** ⁵¹³ globally is useful if that type needs to be reused within the same schema or in another schema. For example, you can define a JSON string type for US telephone numbers in one JSON schema, and then reference this definition not only from within the same schema but also from other JSON schemas.

Adding a definition, and related actions

The following actions are available for adding and editing definitions in the Definitions Overview Grid.

- *To add a definition:* Click the **Append Named Schema Definition** or **Insert Named Schema Definition** icon at the top left of the Definitions Overview Grid (*see screenshot above*). A new empty definition will be created in the grid at the location where you append or insert; it will have a default name. The new definition will also be listed in the Overview entry helper as a *Def* (*see screenshot above*).
- *To change the type of a definition:* Every new definition is created with a type of `Any`. You can change its type in the Details entry helper (*see screenshot below, where the type is 'String'*) or by editing the definition in **Design View** ⁵³².

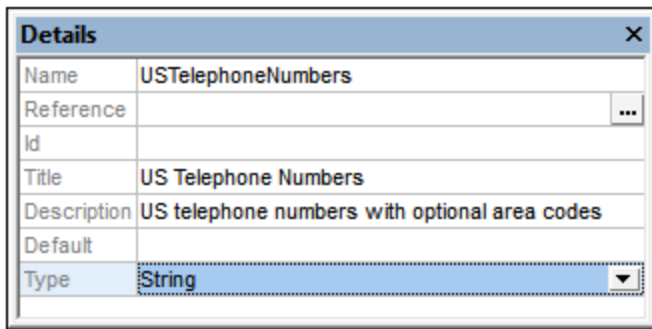

- *To rename a definition:* Double-click its name and edit the name. Alternatively, edit the *Name* field in the [Details entry helper](#)⁵²⁸.
- *To enter a description of the definition:* Edit the *Description* field in the [Details entry helper](#)⁵²⁸. The description appears in the Definitions Overview Grid next to the name of the definition (see *screenshot below*). You can also double-click in the Description field of Definitions Overview Grid to edit a description.

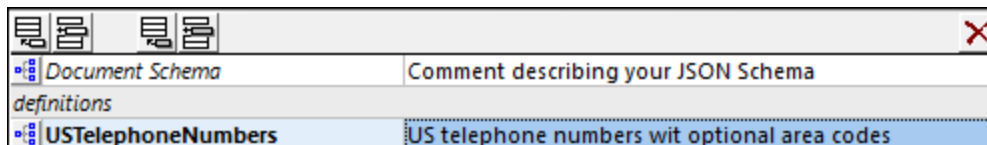

- *To reference a definition:* See the description of the [Overview entry helper](#)⁵²⁷ and the section [Global and Local Definitions](#)⁵³⁰.
- *To edit a definition:* Click the definition's icon in the Definitions Overview Grid or double-click the definition in the [Overview entry helper](#)⁵²⁷. This opens the definition in Design View, where it can be edited.

13.6.3 Entry Helpers: Overview, Details, Constraints

The JSON Schema View entry helpers are located by default on the right-hand side of the application window. They are available in [both modes of the main window](#)⁵²³: (i) Definitions Overview Grid, and (ii) Design View. You can drag entry helper windows by their title bars to other locations on the screen, and you can double-click an entry helper's title bar to alternatively dock and undock that entry helper. For more information about these actions, see the section [Entry Helpers](#)¹¹².

Overview entry helper

The Overview entry helper (*screenshot below*) lists the current schema definition and all the global definitions of the current schema. Double-clicking a definition, opens that definition in [Design View](#)⁵³², where it can be edited. If you wish to use definitions from external schemas, first add the external schema, then reuse the definition you want.

Adding the external schema

Add the external schema by clicking the **Add New Schema** icon in the Overview entry helper and then browsing for the schema you wish to add. Once a schema has been added, its definitions are displayed in the Overview entry helper. The screenshot below, for example, shows that the schema `TelNumbers.json` has been added, and that this schema has one definition named `USTelephoneNumbers`. You can add as many external

schemas as you like.

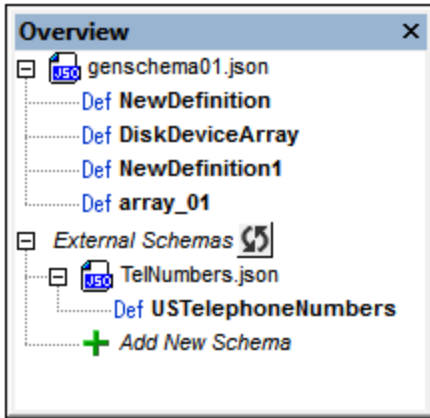

Reusing an external definition

After an external schema has been added, its definitions become available for reuse in the definitions of the importing schema. When one definition reuses another definition (by referencing it), it takes on the properties of that definition. The referencing can be done in two ways:

- *In Design View:* By dragging a definition from the Overview entry helper onto the definition where it is wanted
- *In Definitions Overview Grid or Design View:* Via the *Reference* field of the Details entry helper of the definition where the reuse is wanted. This is explained below in the description of the [Details entry helper](#)⁵²⁸.

Note: The **Refresh** icon next to the *External Schemas* entry in the Overview window updates all added external schemas. Note that, if no definition from an added external schema has been reused, then that schema will be removed from the list when the list is refreshed.

Details entry helper

The properties of a definition can be entered in the Details and Constraints windows when the definition is selected in either mode of the main window: [Definitions Overview Grid or Design View](#)⁵²³. The screenshot below shows the definition of `USTelephoneNumbers` in [Design View](#)⁵³², together with the Detail and Constraints entry helpers. Notice that the information in the two entry helpers is also displayed in the definition's (blue) box in Design View. The properties that can be set in these two entry helpers are listed below.

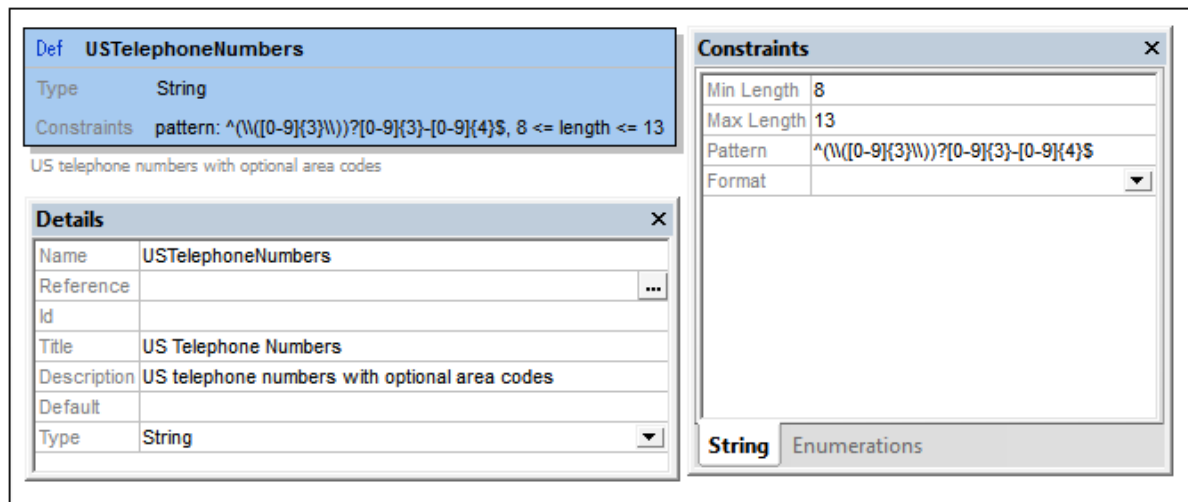

The following details can be entered in the Details entry helper:

- *Name*: The name of the definition.
- *Reference*: If you want a definition to reuse another definition, click the **Additional Dialog** button of the *Reference* field (see screenshot above). This displays the Edit Reference dialog, which lists all available definitions (from the current schema and external schemas). Select the definition you want to reuse, select the *Relative Path* option if you want a relative path, and click **OK**. See [Global and Local Definitions](#)⁵³⁰ for details.
- *Type*: Select the definition's datatype from the dropdown list of the combo box. Note that changing the type will lead to the removal of keywords specific to the previous type. If you wish to go back to the previous definitions, press **Undo (Ctrl-Z)**. The types are explained in [JSON Data](#)⁵¹⁰ and [Type Selectors \(Any, Multiple, etc\)](#)⁵⁴⁸.
- *ID*: This is an optional keyword that defines a URI for the schema. This URI can be used to reference the schema and is used as the base URI for other URI references within the schema. The ID value must be a string that is a URI. Note that the Altova JSON validator uses canonical de-referencing only. See the [JSON specification](#) for more information.
- *Anchor (new in draft-2019-09)*: This is an optional identifier keyword that provides a plain name fragment (and not a URI as is the case with ID). The value of *Anchor* must be a string as described in the respective drafts.
- *Title, Description*: The values of these two keywords are used for descriptive purposes that can be read by the end-user.
- *Comment (new in draft-07)*: Intended for notes to schema maintainers, as opposed to Description, which is intended for end-users.
- *Const (new in draft-06)*: A constant value, like a one-value enumeration.
- *Default*: The default value of the definition.
- *Read-only, Write-only (new in draft-07)*: These indicate, respectively, read-only and write-only fields. An example of a write-only field would be a password field.
- *Deprecated (new in draft-2019-09)*: An indicator that the selected definition may be removed in the future. Applications can handle such definitions in a special way.

Constraints entry helper

A definition's constraints depends on its type. The constraints of each type are described below. (See also [Atomic Types](#)⁵⁴⁶.)

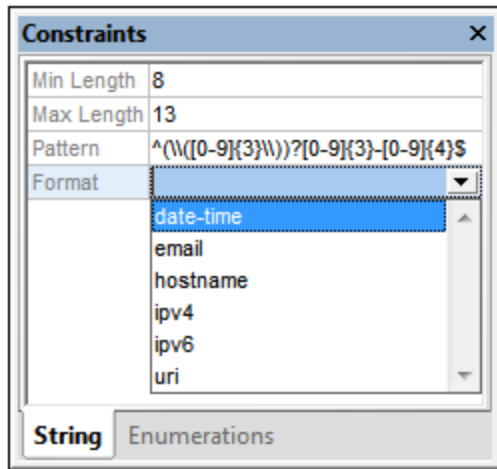

If a type does not appear in the list below, no constraint can be defined for it. Note, however, that enumerations can be defined for all types:

- *String*: The length of the string, and the pattern of the string; the pattern is specified by means of a regular expression. In the *Format* field, you can select one of the [string formats defined in the specification](#) (see screenshot above, which shows the formats available in draft-04); additional formats have been defined in later versions. *Content Media Type* and *Content Encoding* (both new in draft-07) select the [media type and encoding of non-JSON data encoded in a JSON string](#).
- *Numeric*: The range of allowed values
- *Array*: The number of items allowed in the array and whether items must be unique
- *Object*: The number of allowed properties

The Constraints entry helper for all types has an Enumerations tab. In it, you can specify a list of allowed items of that definition's type. Additionally, an Examples tab is available (new in draft-06) for all types except *Forbidden*. This is an array of examples with no validation effect; the value of `default` is usable as an example without repeating it under this keyword.

13.6.4 Global and Local Definitions

JSON schema definitions can be created globally or locally.

- **Global definitions** are created in the [Definitions Overview Grid](#)⁵²³ of the main window by [adding a definition and then specifying its properties](#)⁵²⁶. A global definition can be referenced by other definitions in the same schema or by definitions in other schemas. This enables the reuse of definitions across your project. All the global definitions of the current schema are displayed in the schema's [Definitions Overview Grid](#)⁵²³. Global definitions from other schemas can be made available for reuse by [adding the external schema](#)⁵²⁷ in the Overview entry helper.
- **Local definitions** are created within global definitions, that is, by adding descendant or sibling definitions to a global definition.

Referencing a global definition

To reference a global definition from within another definition, do one of the following:

- In Design View, drag the global definition from the [Overview entry helper](#)⁵²⁷ onto the definition where it is to be used.
- In [Design View](#)⁵²³, right-click the definition for which you want to reference a global definition and select **Edit Reference**. (Alternatively, with the definition selected in Design View, go to its [Details entry helper](#)⁵²⁸ and click the **Additional Dialog** button of the *Reference* field.) In the Edit Reference dialog that appears (*screenshot below*), select the global reference you want to reference. If you add an external schema, you can choose whether the reference should be entered as a filepath relative to your JSON schema or as an absolute filepath.

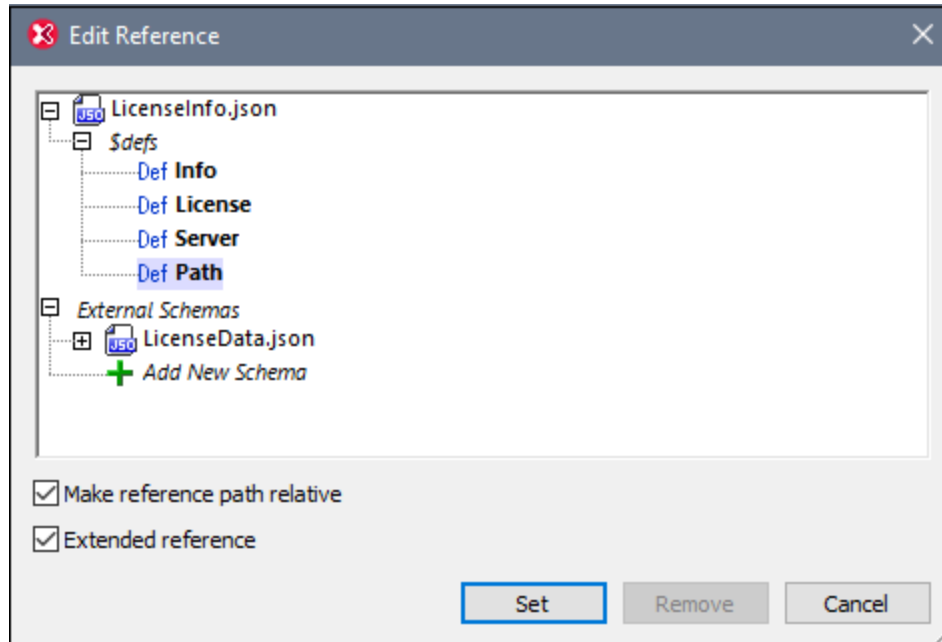

Note: A definition can (i) reference a global definition and not contain any local definition or local constraint, or (ii) both reference a global definition as well as contain local definitions/constraints (from *draft-2019-09* onwards). In the latter case, the reference is known as an **extended reference**. In the Edit Reference dialog, you can create a reference to a global definition as an extended reference by checking the dialog's *Extended reference* check box. A global definition which is created as an extended reference is always displayed as the last item in the list of the referencing component's definitions. If a value exists for the referencing component's *description* keyword, then this value is displayed below the referencing component.

Note: If you change the name of a global definition after it has been referenced by another definition in the same schema, then the name is also changed in the reference. References from other schemas, however, will need to be edited manually to reflect the name change.

Converting local definitions to global definitions

To convert a local definition, right-click it in [Design View](#)⁵³² and select **Make Global**. A global definition is created and a reference to it will be created on the local definition. Since the name of the global definition is generated automatically, you can edit it and the change will be passed to the reference of the local definition.

Changing a ref to a global definition into a local definition

A reference to a global definition can exist on both local and global definitions. To remove the reference and make its properties local, right-click the (local or global) definition in [Design View](#)⁵³² and select **Make Local**. The global definition's properties are created locally on the definition.

13.6.5 Design View

In Design View, you can specify the structure and allowed values of individual global definitions. The definitions are specified via the following GUI components or mechanisms:

- the [Details entry helper](#)⁵²⁸ (also available in Definitions Overview Grid)
- the [Constraints entry helper](#)⁵²⁹ (also available in Definitions Overview Grid)
- the definition's context menu (accessed by right-clicking the definition's box in the main window)

The definitions that can be specified via the Details and Constraints entry helpers are described in the section [Entry Helpers: Overview, Details, Constraints](#)⁵²⁷. Some of these properties can also be specified within the definition's box in the main window. In this section, and the next three sections, we describe the mainly graphical mechanism available in the main window.

Note: If you need to undo an inadvertent or unwanted change, press **Ctrl+Z**.

Context menu

The context menu of a definition (*blue box in screenshot below*) enables you to design the structure of the definition and edit its properties.

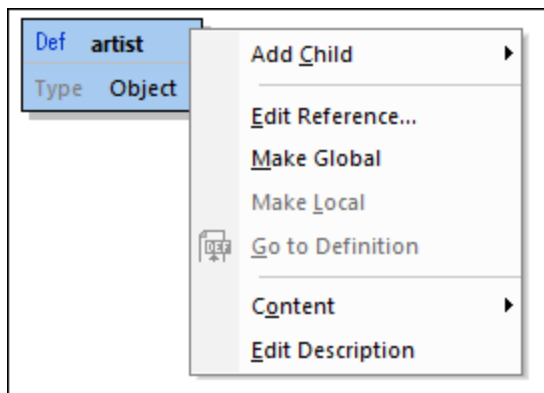

The following commands are available:

- *Add Child*: What child can be added depends on the type of the definition (see [Add Child: creating structure](#)⁵³³ below).
- *Edit Reference*: Enables the definition to reference a global definition and take on the properties of that global definition. The Edit Reference dialog that the command opens is the same as that accessed via the [Details entry helper](#)⁵²⁸ and is described in the section [Entry Helpers: Overview, Details, Constraints](#)⁵²⁸.

- *Make Global*: This command is enabled when the definition is a [local definition](#)⁵³⁰. It makes the currently selected definition a [global definition](#)⁵³⁰ and adds a reference to that global definition in the current selection.
- *Make Local*: This command is enabled when the definition is a [global definition](#)⁵³⁰. It converts the currently selected definition to a [local definition](#)⁵³⁰ by creating a reference to the original global definition.
- *Go to Definition*: If the selected definition is contained within a definition that references a global definition, then this command is enabled. Clicking it takes you to the global definition.
- *Content*: The **Content** command displays a submenu containing commands to cut, copy and reset the contents of the selected definition.
- *Edit Description*: Enables the definition's *Description* field to be edited.

Add Child: creating structure

The structure of a definition is created by adding multiple levels of descendants. These levels are created with the **Add Child** command of the context menu. The children that can be added to a definition depends on its type:

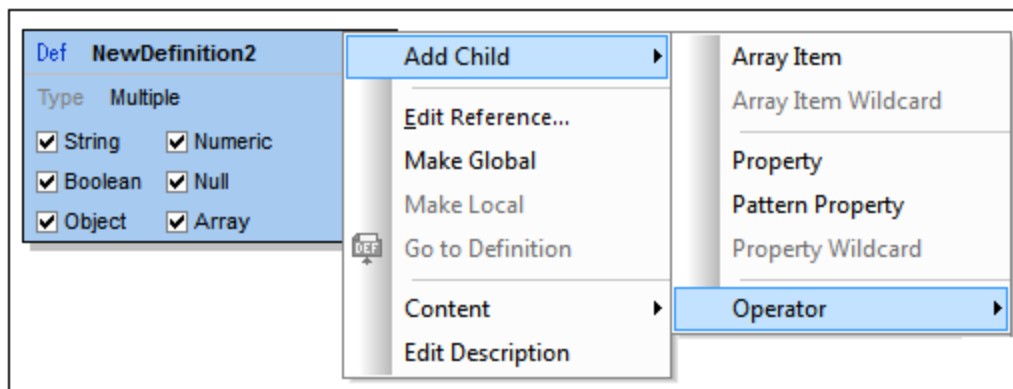

- [Objects](#)⁵³³: take properties and operators
- [Arrays](#)⁵⁴⁴: take array items and operators
- [Atomic types \(string, number, boolean, null\)](#)⁵⁴⁶: take operators
- [Any](#)⁵⁴⁸: takes properties, array items, and operators
- [Multiple](#)⁵⁴⁸: varies according to what types are included; takes the union of allowed children for the selected types
- [Operators](#)⁵⁵⁴: enables logical operators to be used to determine the structure

The structures that can be created for each type are described in detail in the sections that are linked to from the list above.

13.6.6 Objects and Properties

An object is enclosed in curly braces and maps a key to a value, like this: `"MyKey": Value`. The key must always be a string and must therefore be enclosed in quotes. The value can be any [JSON data type](#)⁵¹⁰. Each `key:value` pair is known as a **property** of the object (see *screenshot below*).

Here is an example of an instantiated object that has three properties:

f

```
"emailtype": "home",
"emailaddress": "contact01.home@altova.com",
"citycode": 22
}
```

The schema for the object would look something like this in Design View.

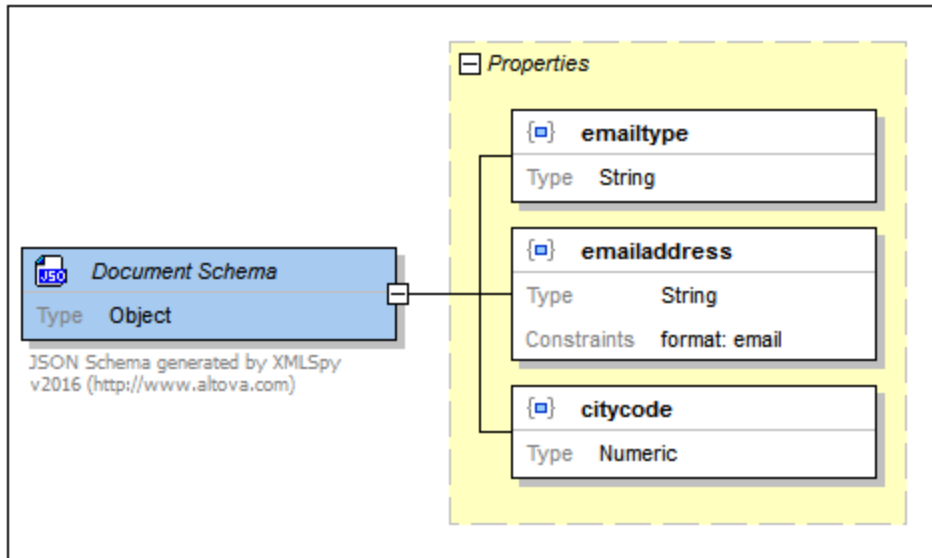

Notice the following:

- Each of the properties must be present in the instance. This is indicated by the solid borders of the properties. If a property is optional, the border is a dashed line. You can set whether a property is required or optional in the property's context menu or via the Details entry helper.
- The order in which properties must occur in the instance is not—and cannot be—defined in the schema. This means that the order in which properties are defined in the schema is irrelevant.
- The blue-square-within-braces symbol signifies a property (as opposed to a pattern property or property wildcard, both of which are indicated by other symbols; [see below](#)⁵³⁴).
- The type of a property can be edited by double-clicking the type in the diagram and selecting an option from the dropdown list that appears. Alternatively, the type can be selected in the Details entry helper.
- The constraint value of the `emailaddress` property is defined in the Constraints entry helper.

Properties, pattern properties, property wildcards, and property names schemas

An object can have properties, pattern properties, property wildcards, and property names schemas ([new in draft-07](#)⁵²⁴). These can be added to the object via the context menus: (i) of the object, (ii) of the yellow properties box (right-click the *Properties* title of the box), and (iii) of individual properties. Properties have been described above. We now look at pattern properties and property wildcards.

Pattern property

A **pattern property** (*screenshot below*) defines the property's name as a regular expression. In the screenshot below, for example, the regular expression specifies that the property must: (i) have a name that begins with an underscore, and (ii) have a boolean as its value. There is no requirement constraint for a pattern property. You can add any number of pattern properties. Notice the icon for pattern properties.

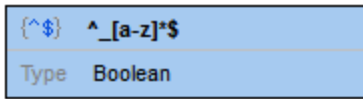

Property wildcard

A **property wildcard** (*screenshot below*) specifies that any number of properties can occur in addition to the other properties of the object's property set. The wildcard can however define a type for these occurrences. The screenshot below left shows a property wildcard that defines properties with any name but having numeric values. There can be only one property wildcard per object. If the wildcard is set to *Any* type, however, then you can set constraints for each type in the Constraints entry helper. Notice the icon for property wildcards.

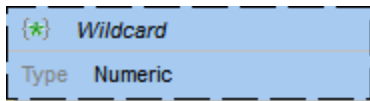

From *draft-2019-09* onwards, property wildcards have a new keyword `unevaluatedProperties`, which is processed only if the `additionalProperties` keyword is missing. The values of these two keywords are produced by setting appropriate values for the *Specified*, *Applies to*, and *Type* entries in a wildcard's Details entry helper (*screenshot below*).

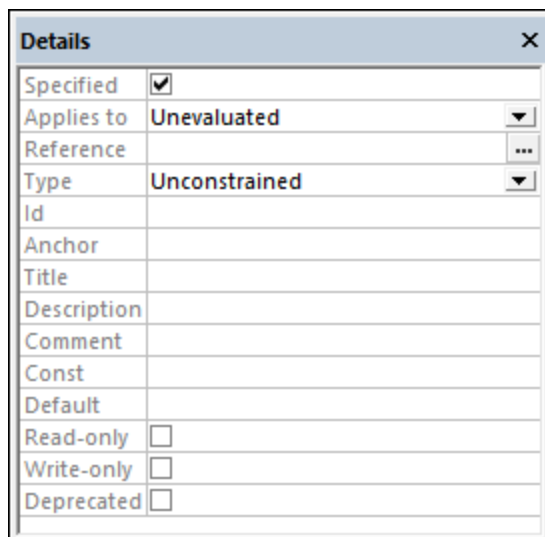

The effect of these values on the keywords `unevaluatedProperties` and `additionalProperties` (and, vice versa, the effect of the keywords on the editor's entry helper values) are given in the table below. The screenshot above, for example, sets `unevaluatedProperties=true`.

additionalProperties	unevaluatedProperties		Specified	Applies to	Type
--	--	<=>	false	All	Unconstrained
true	ignored	<=>	true	All	Unconstrained
false	ignored	<=>	--	--	--
Schema	ignored	<=>	true	All	Schema type

--	true	<=>	true	Unevaluated	Unconstrained
--	false	<=>	true	Unevaluated	Forbidden
--	Schema	<=>	true	Unevaluated	Schema type

Note the following points:

- If `additionalProperties` and `unevaluatedProperties` are present, then `unevaluatedProperties` is ignored.
- `Specified=false` only works with `Scope=All` and `Type=Unconstrained`.

Property names schema

A **property names schema** (screenshot below) constrains the names of that object's properties. (This feature is [new in draft-07](#)⁵²⁴.) For example, in the screenshot below, we can see that the names of properties must be strings. Additionally, we can specify further constraints for the property name via the Constraints entry helper: for example, that the property's name fall within a certain character length range or that it have a certain pattern.

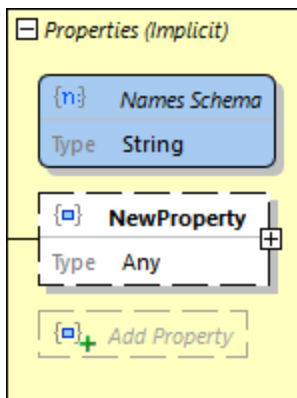

Note: There are no minimum or maximum occurrence settings for a pattern property or property wildcard. See the section about [property validation](#)⁵³⁶ to understand this better.

How properties are validated

When a property is encountered in the instance, it is validated as follows:

1. The property's name is checked in the schema against all the named properties of that object.
2. If no match is found, the name is checked against all pattern properties in the object's property set.
3. If still no match is found, then the wildcard is invoked if it exists.
4. If still no match is found for the name, a validity error is reported. If the name matches that of a property or pattern property, or if a wildcard exists, then the value is checked against the value of the corresponding property definition.
5. If the instance value matches the type and constraints of the corresponding property definition, then the property is valid. Otherwise it is invalid.

Example

The screenshot below defines an object which:

- must have three properties named `emailtype`, `emailaddress`, and `citycode`
- can have one or more properties with a name that begins with an underscore and a value that is a boolean (see the pattern property in the screenshot below)
- can have one or more additional properties with any name and any value

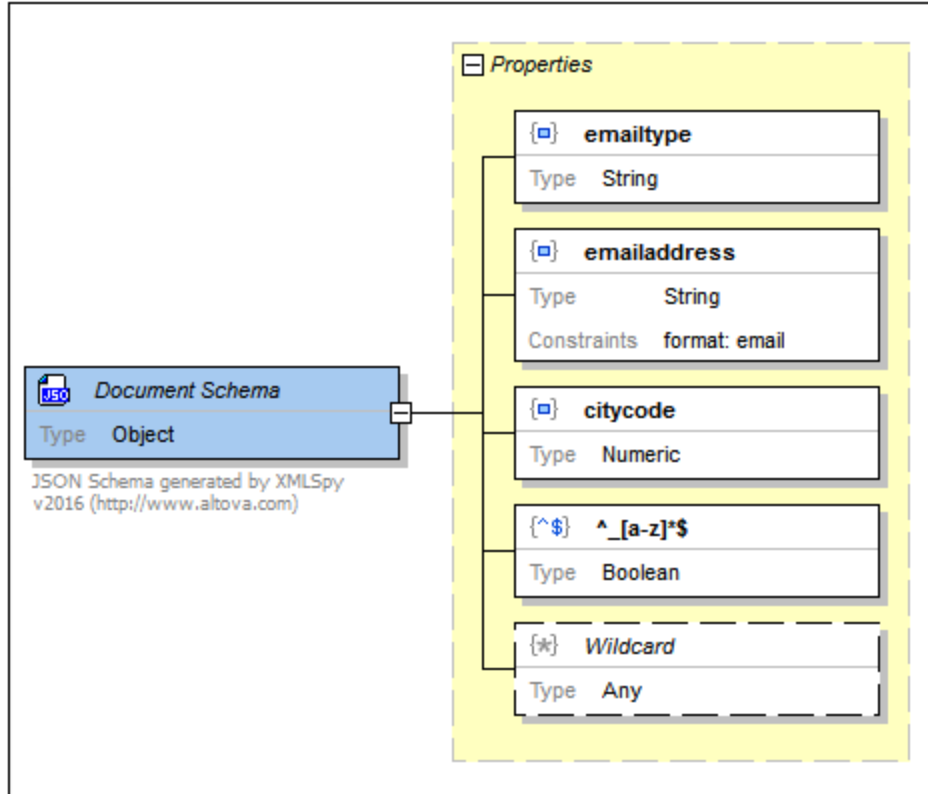

13.6.7 Unspecified Properties

In the code listing below, the `required` keyword specifies that four properties are required for this object. However, of the four properties that are required, only three have been defined. The fourth property, `city`, is undefined. The defined properties are said to be **specified**, while the undefined property is said to be **unspecified**. See the screenshots below the listing.

Code listing: specified and unspecified properties

```
{
  "$schema": "http://json-schema.org/draft-04/schema#",
  "description": "JSON Schema generated by XMLSpy v2016 (http://www.altova.com)",
  "type": "object",
  "properties": {
    "emailtype": {
      "type": "string"
    },
    "emailaddress": {
```

```
        "type": "string",
        "format": "email"
    },
    "citycode": {
        "type": "number"
    }
},
"required": [
    "emailtype",
    "emailaddress",
    "citycode",
    "city"
],
"additionalProperties": false
}
```

The image contains two screenshots of a JSON Schema editor interface. Each screenshot shows a 'Properties' pane on the left and a 'Details' pane on the right.

Top Screenshot: The 'emailtype' property is selected in the Properties pane. The Details pane shows the following information:

Name	emailtype
Occurrence	Required
Specified	<input checked="" type="checkbox"/>
Reference	...
Id	
Title	
Description	
Default	
Type	String

Bottom Screenshot: The 'city' property is selected in the Properties pane. The Details pane shows the following information:

Name	city
Occurrence	Required
Specified	<input type="checkbox"/>

In Design View, the unspecified property is flagged in red because it is required by the schema, but is not defined. Although the JSON schema itself is valid, an instance document that is validated against it will not be valid. This is because: (i) If the `city` property is not present, the document will be invalid because the `city` property is required; (ii) If the `city` property is present, the document will be invalid because the `city` property is undefined and there is no property wildcard to allow its presence (see [Implicitly Specifying a Property](#)⁵³⁷ below).

To create a definition for an unspecified property, do the following:

1. Select the unspecified property in Design View.
2. In the Details entry helper, check the *Specified* check box (see screenshot above). Alternatively, the *Specified* flag can be modified via the context menu.

3. Modify the property's definition as required.

Implicitly specifying a property

A property can be implicitly specified by adding a suitable pattern property or property wildcard. The screenshot below shows that a property wildcard has been added. An instance property named `city` will match this wildcard. In the schema, therefore, the `city` property is said to be implicitly specified by the wildcard. An instance file containing the `city` property will be valid against this schema.

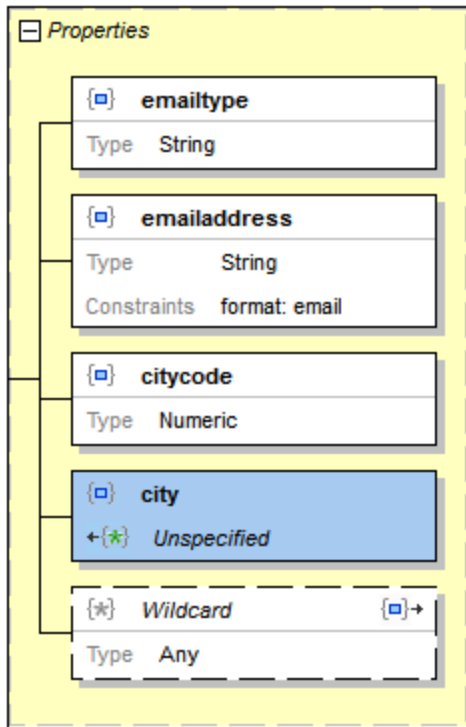

Notice the respective icons in the implicitly specified property and in the property wildcard. Each icon is a link to the other property. Double-clicking one icon selects the other property.

13.6.8 Objects and Dependencies

Within the definition of an object, you might want to specify that a certain property is to be present only if another property is present. The first property is said to be dependent on the second property. Here is a scenario containing a dependency. An object (named, say, `member`) has a property called `credit_card`, which is defined as optional. The object's `billing_address` property can be made dependent on the `credit_card` property: Only if the `credit_card` property is present will the `billing_address` property be present.

This kind of dependency can be specified in one of two ways:

- as a property dependency (the dependent structure is a property)
- as a schema dependency (the dependent structure is a schema)

Property dependencies

The screenshot below shows an object having a `name` property (required), a `credit_card` property (optional), and a `billing_address` property (dependent). The `billing_address` property is dependent on the `credit_card` property. The code of this JSON object definition is listed below the screenshot. How to create a property dependency is described further below.

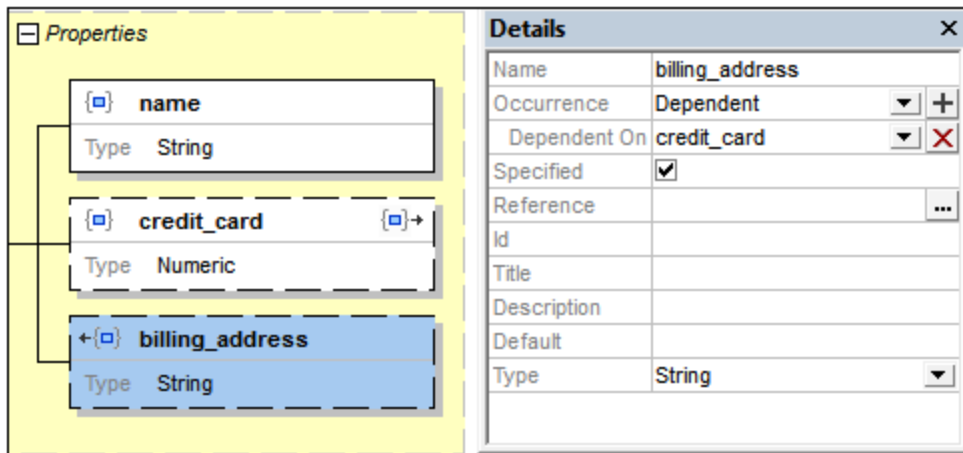

Code listing of a JSON object with a property dependency

```
{
  "type": "object",
  "properties": {
    "name": {
      "type": "string"
    },
    "credit_card": {
      "type": "number"
    },
    "billing_address": {
      "type": "string"
    }
  },
  "required": [ "name" ],
  "dependencies": {
    "credit_card": [ "billing_address" ]
  },
  "additionalProperties": false
}
```

To create a property dependency, do the following:

1. Right-click the property on which the dependency will be based. (In our example this is the `credit_card` property.)
2. In the context menu that appears, select **Add Dependency | Dependent Property**. A new property is added with an Occurrence value of *Dependent*.
3. Define the name and value of this property, and add any additional details or constraints you want.

To specify a property as being dependent on another property, do the following:

1. Right-click the property you want to make dependent on another property. (In our example this is the `billing_address` property.)
2. In the context menu that appears, select **Dependent**. Alternatively, in the Details entry helper, go to the *Occurrence* entry, and select *Dependent* (see screenshot above).
3. In the Details entry helper, click the dropdown list icon of the *Dependent On* entry. The dropdown list displays all the other properties of the object. Select the property on which you want the current property to depend.

Note: An icon appears in the boxes of both properties involved in a dependency (see screenshot above). Double-clicking the icon of one property takes you to the other property.

Note: A property can have multiple dependent properties.

Schema dependencies

The screenshot below shows an object that describes the same instance data structure as the object discussed in the previous section. The definitions of the two objects, however, are different. While the previous definition used a *property dependency* to define the `billing_address` property as being dependent on the `credit_card` property, the current definition uses a *schema dependency* to define this dependency. The code of this latter JSON object definition is listed below the screenshot. How to create a schema dependency is described further below

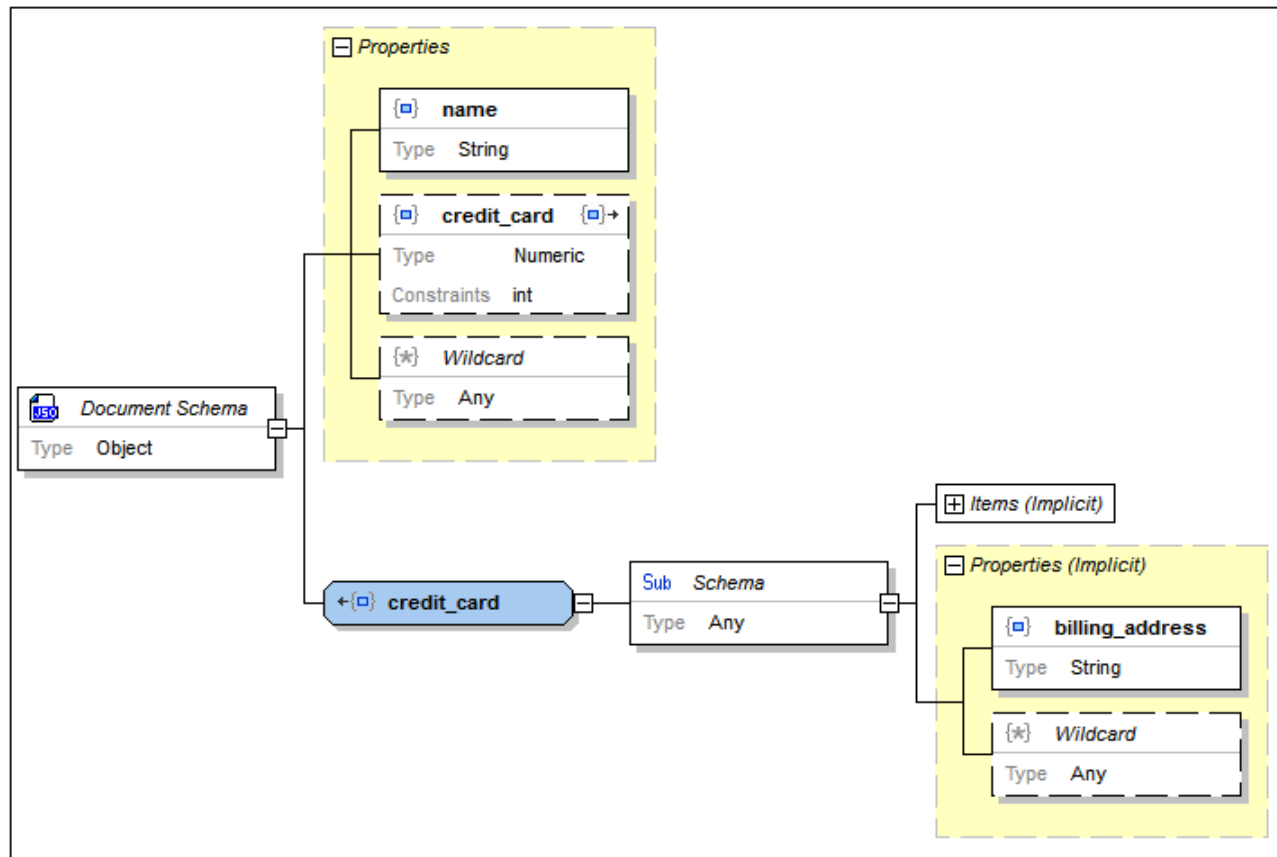

Code listing of a JSON object with a schema dependency

```

{
  "type": "object",
  "properties": {
    "name": {
      "type": "string"
    },
    "credit_card": {
      "type": "integer"
    }
  },
  "required": [ "name" ],
  "dependencies": {
    "credit_card": {
      "properties": {
        "billing_address": {
          "type": "string"
        }
      },
      "required": [ "billing_address" ]
    }
  }
}

```

To create a schema dependency, do the following:

1. Right-click the property on which the dependency will be based. (In our example this is the `credit_card` property.)
2. In the context menu that appears, select **Add Dependency | Schema Dependency**. A new object definition is created. It will have the same name as the property on which it is dependent (in our example, `credit_card`), and it will have a child sub-schema.
3. Define the sub-schema the way you want it, adding any additional details or constraints you may want.

Note: An icon appears in the boxes of the property and object involved in a dependency (see *screenshot above*). Double-clicking the icon in one box takes you to the other box.

Note: If you wish to set multiple dependencies, do this within the dependent sub-schema (see *screenshot above*).

13.6.9 Arrays

An array is a list of zero or more ordered items; it is delimited by square brackets. Each item in the list is assigned a type. The instance listing below is of an object with three properties. The value of each property is an array (*delimiters highlighted in yellow*).

```
{  
  "x": [ 1, 2, "abc" ],  
  "y": [ 3, 4, "def" ],  
  "z": [ 5, 6, "ghi" ]  
}
```

All three arrays in the listing above have the same definition. Each contains three ordered items in the following order: (i) a number item, a (ii) a number item, (iii) a string item. A schema description of this object is shown in the screenshot below. Since the definition is the same for all three arrays, the definition has been created in a global array named `array_01`. Each of the three arrays (`x`, `y`, and `z`) [references the global array](#)⁵³⁰ `array_01`.

The screenshot displays a JSON Schema editor. On the left, a definition for `object_01` is shown as an Object type. The main workspace, titled "Properties", contains three array definitions: `x`, `y`, and `z`. Each array is of type `array_01` and has constraints `3 <= items <= 3`. The `x` array is highlighted in blue. To the right, two panels are open: "Constraints" and "Details". The "Constraints" panel shows `Min Items` and `Max Items` both set to 3, and `Unique Items` is unchecked. The "Details" panel shows the `Name` as `x`, `Occurrence` as `Required`, `Specified` checked, `Reference` as `array_01`, `Title` as `x`, `Description` as `tuple type`, and `Type` as `Array`.

In the screenshot above, array `x` is selected (indicated by its blue highlight), and its details and constraints are shown in the respective entry helpers (see screenshot above). Notice the constraint on the number of allowed items. The number can be edited in the Constraints entry helper and is displayed in the diagram. The array items can be defined in the definition of the array itself, which in this case is the global definition `array_01` (screenshot below).

This screenshot shows the definition of the `array_01` type. It is an Array type with constraints `3 <= items <= 3`. The main workspace, titled "Items: 3..3", contains three items: `[0]` (Type: Numeric), `[1]` (Type: Numeric), and `[2]` (Type: String). The `array_01` definition is highlighted in blue. To the right, the "Constraints" panel is open, showing `Min Items` and `Max Items` both set to 3, and `Unique Items` is unchecked. The "Array" tab is selected in the bottom right.

Note the following points:

- The `unique` constraint specifies that all items in the array must be unique.

- The numbering of items starts with 0.
- The following phrasing in the diagram, $3 \leq \text{items} \leq 3$ and *Items: 3..3* (see screenshot above), both indicate the minimum and maximum allowed items. In this case, exactly three items must be present.

Adding array items, array item wildcards, and the contains keyword

Array items, array item wildcards, and an array's `contains` keyword are added via the context menu of a definition or an array item.

- An array item wildcard enables a broader range of objects to be included in the array.
- The `contains` keyword specifies that the value of the `contains` keyword must be a valid JSON schema and that at least one of the array's elements must be valid against the referenced schema object. From draft 2019-09 onwards, the keywords `minContains` and `maxContains` have been introduced. In the Details entry helper, these are shown as the *Min* and *Max* properties of the Contains box (see screenshot below), and they define how many items may match the referenced schema object.

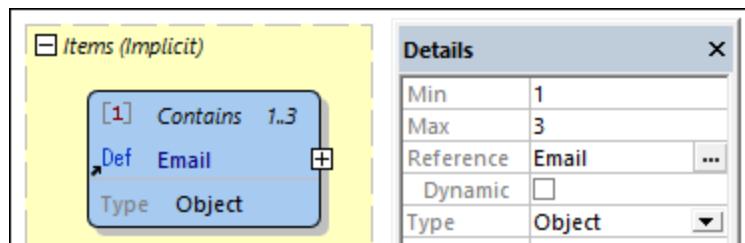

13.6.10 Atomic Types

There are five JSON atomic (aka simple or primitive) types: (i) `string`, (ii) `number`, (iii) `integer`, (iv) `boolean`, and (v) `null`. To specify that a definition is one of these atomic types, do one of the following:

- Double-click the `Type` value field in the definition's box, and select the type
- In the Details entry helper, select the type from the dropdown list in the `Type` field.

The constraints of each atomic type are described below.

String

For the string type, you can specify the following constraints: (i) length of the string, (ii) a regular expression that describes the pattern of the string, (iii) a [predefined format from the specification](#).

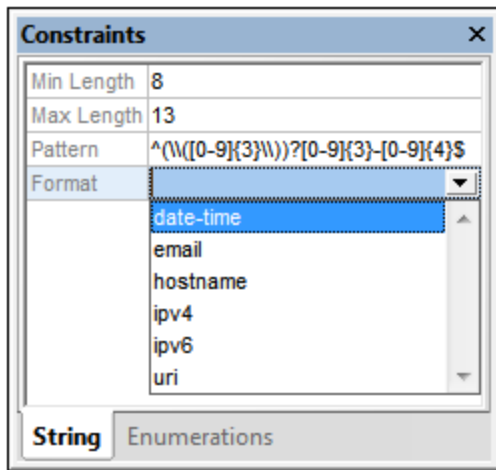

Note: In the [JSON Validation settings](#)¹⁰⁵³ of XMLSpy, you can specify whether the format of strings in JSON instance documents must be validated or not.

Numeric

The numeric type is a collective name for two types (`number` and `integer`; see *screenshot below*). The actual type is set in the *Mode* field (the default of which is `number`). The difference between the two types is that the `number` type allows decimals, whereas the `integer` type does not. If a value exists in the [MultipleOf](#) field, then the instance value must be an integer multiple of the *MultipleOf* value.

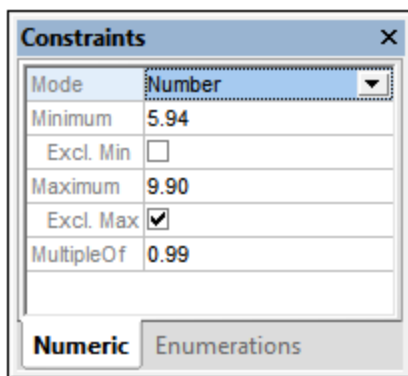

Valid values for the `number` type defined in the screenshot above are: 5.94, 6.93, 7.92, and 8.91.

Boolean and Null

The `boolean` type takes either `true` or `false` as its values. The `null` type takes `null` as its value. Neither type takes any constraint.

13.6.11 Type Selectors (Any, Multiple, etc)

In the dropdown lists of the Type combo boxes of JSON Schema View, there are four "types" that are not JSON types: **any**, **multiple**, **unconstrained**, and **forbidden**. These are actually type selectors.

- The **any** type selector selects any JSON type. This means that, in the instance, any JSON type will be valid for that particular definition.
- The **multiple** type selector selects one or more JSON types. This means that if the instance type is one of the JSON types selected in the schema, then the instance type will be valid for that particular definition.
- The **unconstrained** type selector ([new in draft-06](#)⁵²⁴) sets no constraint on the JSON type. This means that, in the instance, any JSON type will be valid for a definition with that name.
- The **forbidden** type selector ([new in draft-06](#)⁵²⁴) forbids any JSON type, effectively not allowing a definition with that name to exist.

The any type selector

The **any** type selector can be selected everywhere that a type can be selected. When a definition is added to the schema, **any** is the default type selection. It specifies that any of the JSON types is valid. This means that the instance type could validly be an object, an array, or any of the atomic types (**string**, **number**, **integer**, **boolean**, and **null**).

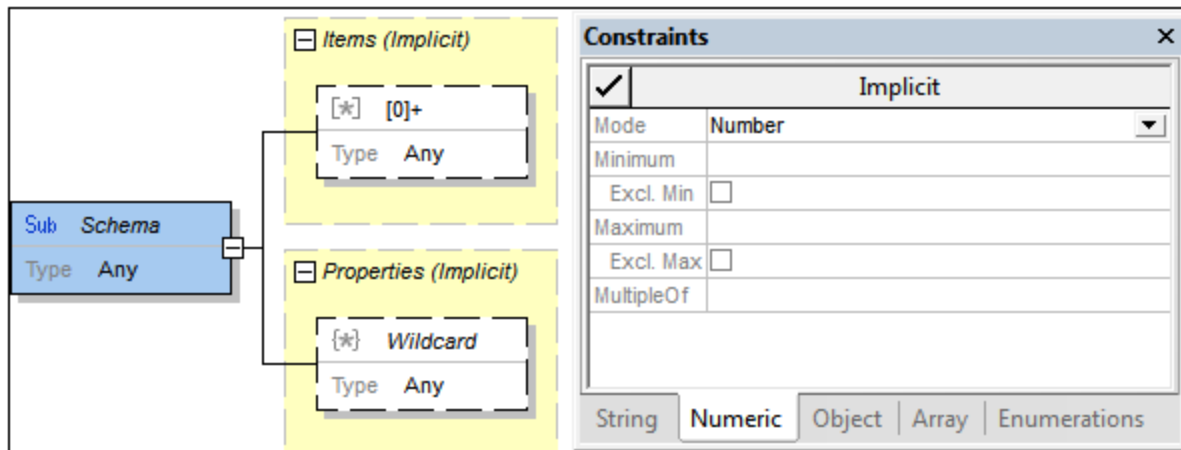

In the screenshot above, the sub-schema has a type of **Any**. So, all JSON types are valid for this definition. The following is implied and is implemented accordingly in the UI:

- Since objects are allowed, a properties box is automatically created (see *screenshot above*). The properties box is defined by default to allow any number of properties of any type (via a property wildcard with a type of **Any**). You can modify the property definitions as you like.
- Since arrays are allowed, an items box is automatically created (see *screenshot above*). The array items box is defined by default to allow any number of array items of any type (via an array item wildcard with a type of **Any**). You can modify the item definitions as you like.
- Since string and numeric (number and integer) types are allowed, constraints for these atomic types can be defined in the Constraints entry helper.

All of these types are therefore implicitly defined with the **Any** type selector. In order to change the type to a specific type, select that type. There is an alternative way to specify objects and arrays as the type: Right-click

the object or array, and select **Make Explicit**. This makes that type the selected type and removes the other types or makes defined object/array types inactive.

The multiple type selector

The `multiple` type selector can be selected everywhere that a type can be selected. It allows you to select one or more JSON types by checking the types you want to allow (see *screenshot below*). You can then specify constraints for the selected types in the Constraints entry helper.

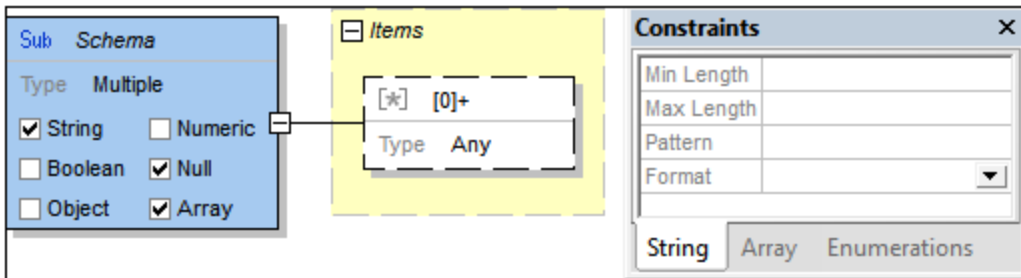

In the screenshot above, the sub-schema allows types of `string`, `null`, and `array`. Constraints for these types can be defined in the Constraints entry helper (see *screenshot*).

- String constraints are defined in the Constraints entry helper.
- The null type takes no further constraints.
- An array items box is automatically created. You can define the number and types of allowed array items.

In an instance document, the selected types will be allowed at the location corresponding to that of the sub-schema.

The unconstrained and forbidden type selectors

The `unconstrained` and `forbidden` type selectors can be selected everywhere that a type can be selected. They enable you to specify, respectively, that an object of any type is allowed or that no object of that name is allowed.

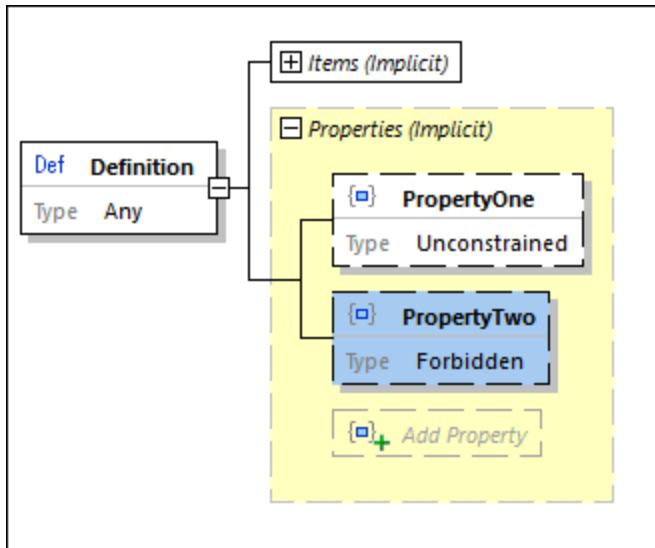

In the screenshot above, a definition has two properties. `PropertyOne` can have a value of any type, whereas no property named `PropertyTwo` is allowed (see screenshot). In text form, this construct will look like the code listing below.

```
"Definition": {
  "properties": {
    "PropertyOne": true,
    "PropertyTwo": false
  }
}
```

13.6.12 BSON (Binary JSON) for MongoDB

The MongoDB application data platform stores data as JSON structures, but in a binary representation of the data. This representation is known as "Binary JSON" or BSON. The main benefits of using BSON for MongoDB are:

- The binary format of BSON is faster to parse than the text of a JSON document.
- Since JSON has limited datatyping, BSON has been provided with [more datatypes](#) (in particular, more numeric datatypes).

For more information about MongoDB and BSON, see [this page at the MongoDB website](#).

Edit JSON schemas for BSON data

MongoDB provides the ability, during the addition of new DB data and the modification of DB data, for the DB data to be validated against a JSON schema document. However, because of the additional BSON datatypes, which are not part of the official JSON schema specifications but supplement them, JSON schemas for BSON are edited in XMLSpy via an editing layer for BSON that is overlaid on the JSON schema editor. This editing

layer enables you to add and modify BSON-specific schema features—in addition to the standard JSON features.

Consequently, you can edit a JSON schema document of any version with or without the BSON editing layer. When the document is edited without the BSON editing layer, it is edited as a straightforward JSON schema document. With BSON support, the JSON schema document can additionally define BSON-specific features. To switch on BSON editing features in JSON Schema View *for the active document*, select the *BSON Support* check box at the top right of the main window (*circled in green in the screenshot below*). Note that BSON support (i) can be switched on regardless of the JSON schema version that has been selected, and (ii) applies to the current document only; it can be switched on/off for each document separately.

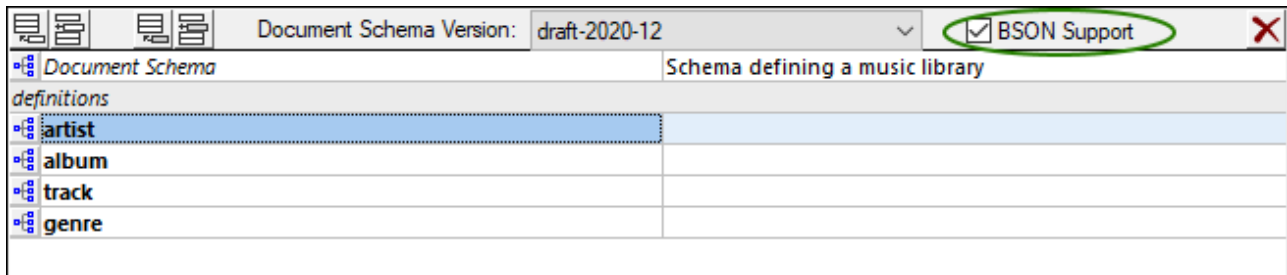

BSON types

After the BSON editing layer has been switched on, BSON datatypes become available for JSON objects, properties, and array items. Specifying that a component is of a BSON type consists of two steps:

1. Specify that the component is a BSON datatype (and not a JSON datatype) by selecting BSON as the base JSON type. Do this either in the component's datatype-selector combo box (by double-clicking the type value; *screenshot below left*) or the component's Details entry helper (*screenshot below right*).

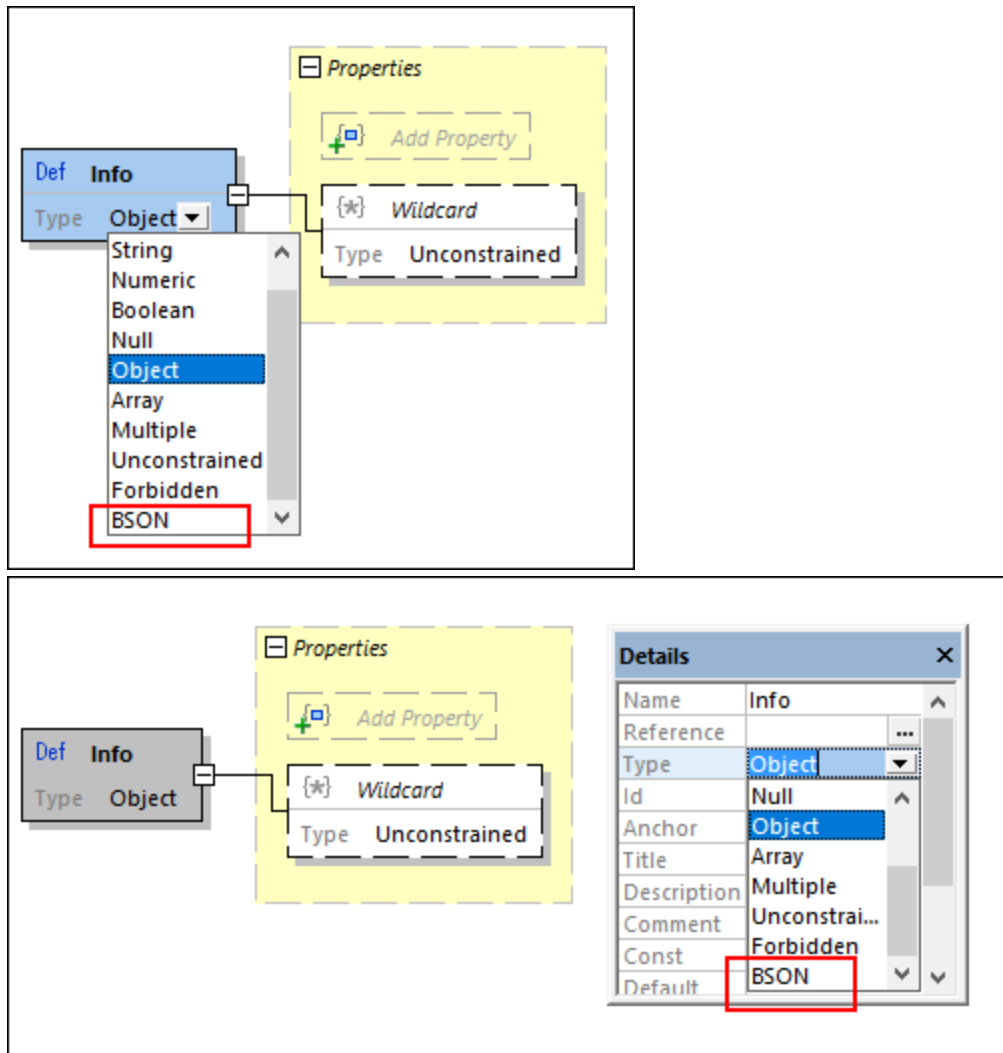

2. After the component's base type has been selected to be *BSON*, the *BSON* types become available for selection. Select the *BSON* type either in the component's datatype selection (*left arrow in screenshot below*) or in the Details entry helper (*tight arrow in screenshot below*).

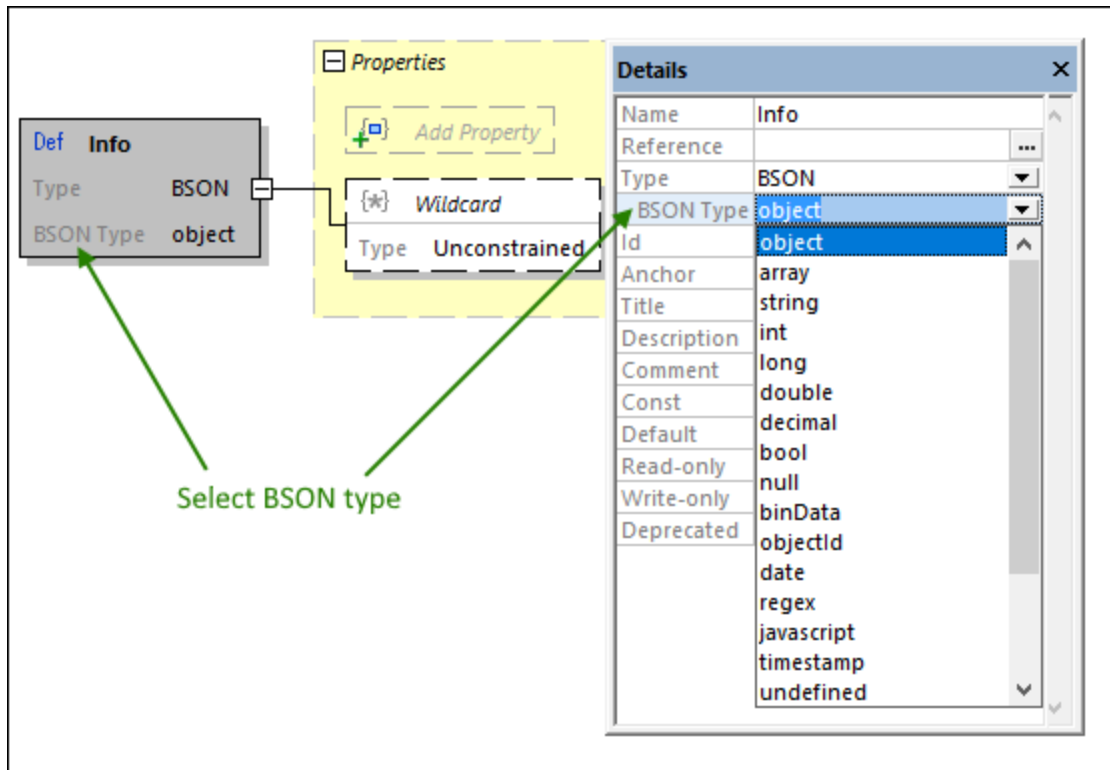

Disabling BSON support

If you assign a BSON type to a JSON schema component (as described above) and then uncheck the *BSON Support* option for the document, a message box will appear. It informs you that there are BSON types in the document and asks whether you want to remove/convert the BSON types or keep them. If you choose to remove/convert, then those BSON types that can be converted to JSON types will be converted while the others will be removed. If you choose to keep the BSON types, then they will be retained—but colored orange in Schema View because BSON type support has been removed (see *screenshot below*).

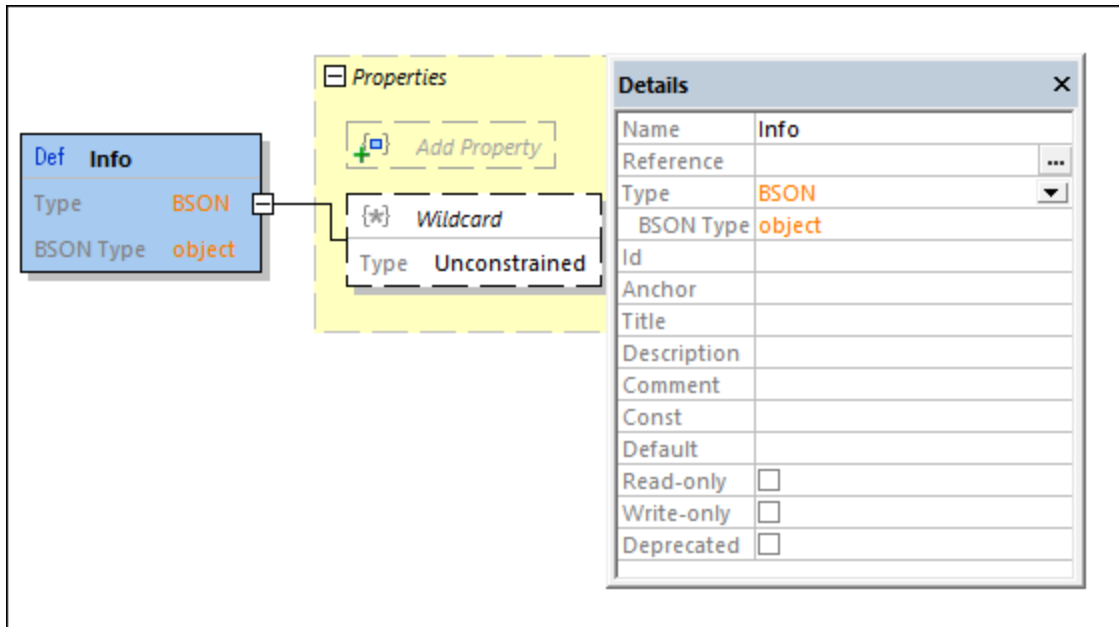



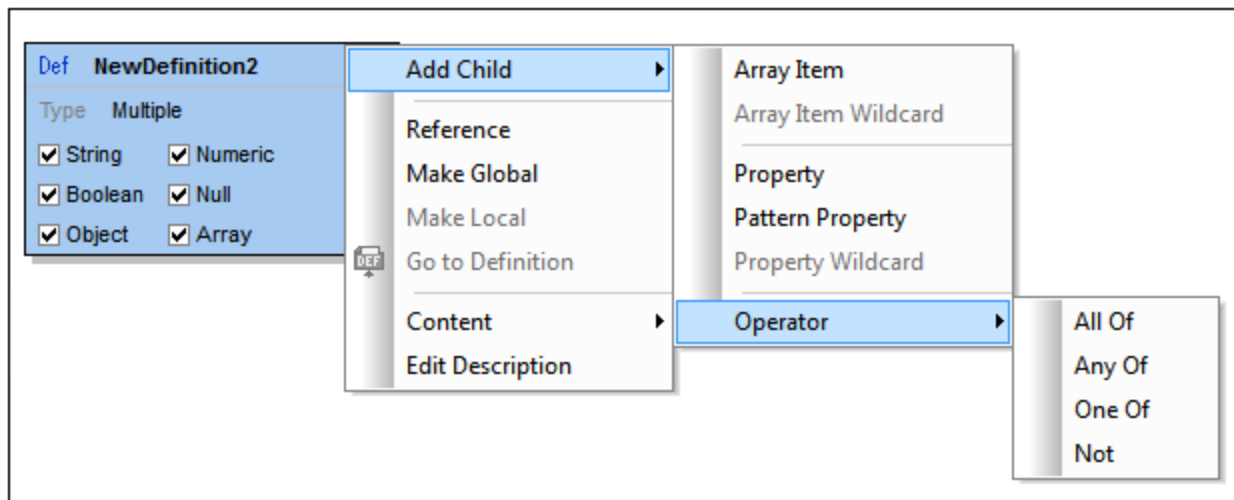

13.6.13 Operators

There are four operators: (i) `allOf`, (ii) `anyOf`, (iii) `oneOf`, and (iv) `not`. Operators are used to specify conditions of validity as explained below. You can add an operator to any definition. To access the operator sub-menu, right-click the definition to which you wish to add an operator, and then select **Add Child | Operator** (see screenshot below).



These operators specify conditions for successful validation, as follows:

Operator	Icon	Description
----------	------	-------------

	<i>All Of</i>	Contains one or more sub-schemas (definitions), added as children of the operator. An instance is valid if it is valid against all these sub-schemas.
	<i>Any Of</i>	Contains one or more sub-schemas (definitions), added as children of the operator. An instance is valid if it is valid against at least one of these sub-schemas.
	<i>One Of</i>	Contains one or more sub-schemas (definitions), added as children of the operator. An instance is valid if it is valid against exactly one of these sub-schemas.
	<i>Not</i>	Contains exactly one sub-schema (definition), added as a child of the operator. An instance is valid if it is invalid against the given definition.

The screenshot below shows a *One Of* operator that contains three child sub-schemas (definitions). For the instance to be valid, it must have one JSON data structure (at this point in the document structure) that matches one of the three sub-schema definitions.

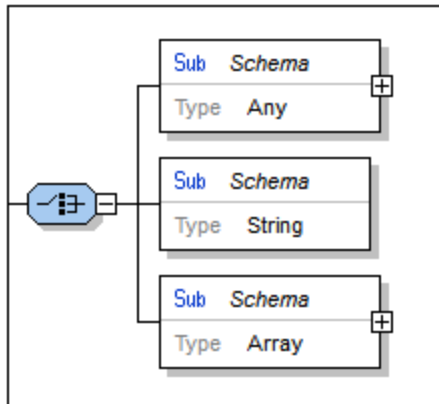

Operators can be useful for specifying inheritance and restriction. The screenshot below, for example, shows how to use the *All Of* operator to define an array containing non-empty unique strings.

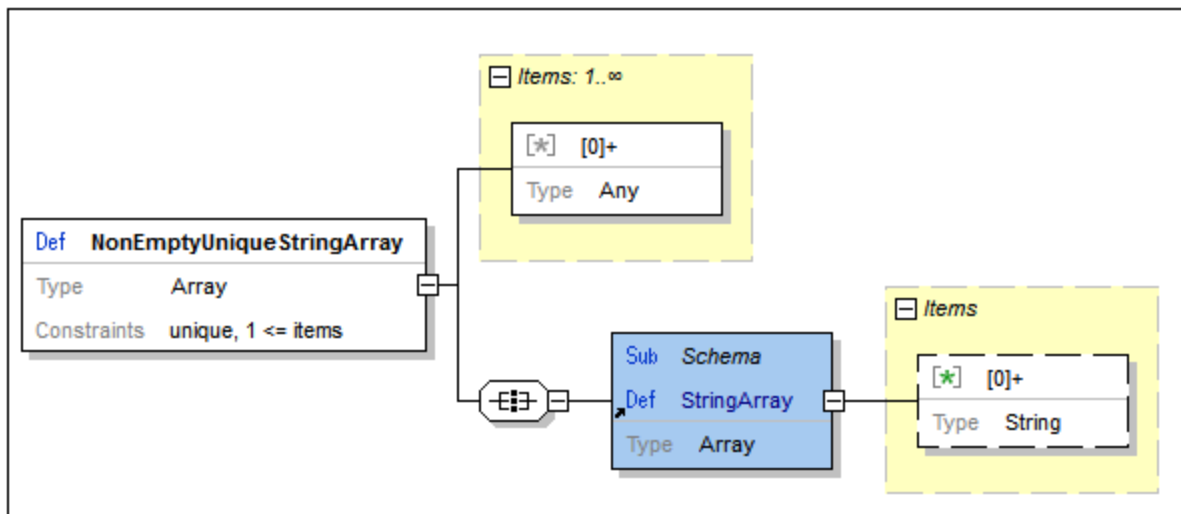

13.6.14 Conditionals

Conditionals are a new feature in [draft-07](#)⁵²⁴. They enable you to specify that validation restrictions are to be different depending on certain aspects of the object, such as its type and/or additional type specific restrictions.

Adding a conditional

You can add a conditional to any definition via the definition's context menu (see *screenshot below*). To access the conditional's sub-menu, right-click the definition to which you wish to add the conditional, and then select **Add Child | Conditional**.

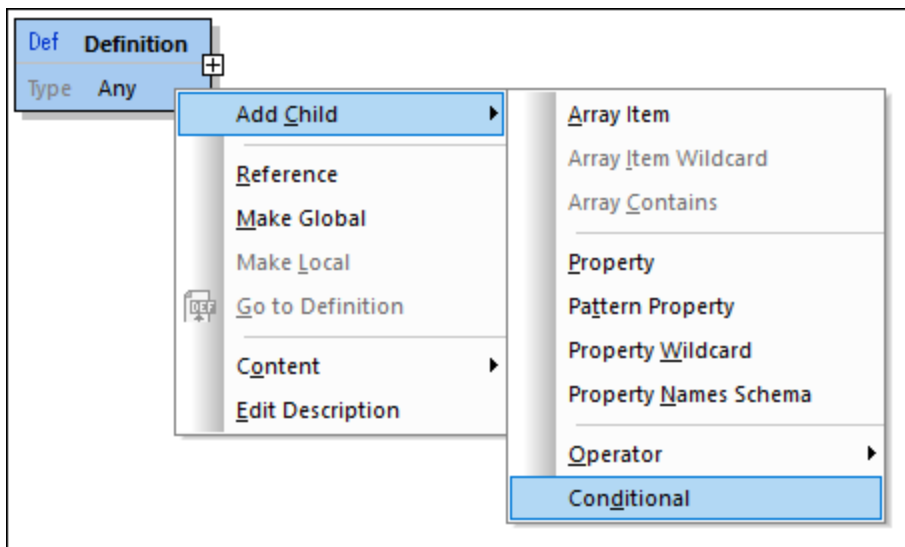

Setting up conditional validation

The conditional is added as a box with three elements: **If-Then-Else** (see *screenshot below*).

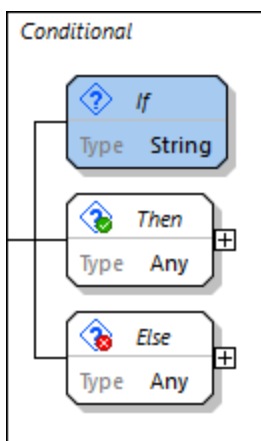

To set up conditional validation do the following:

1. Set up the condition in the *If* box by first selecting a type in the Details entry helper and then a type-based constraint in the Constraints entry helper.
2. In the *Then* box, set up the validation requirements in the event that the condition (specified in the *If* box) is fulfilled.
3. In the *Else* box, set up the validation requirements in the event that the condition (specified in the *If* box) is not fulfilled.

13.6.15 Configuring Design View

When the main window is in Design View mode, you can access the Display Configuration dialog (*screenshot below*) via the menu command **Schema Design | Configure View**. Here you can configure the appearance of Design View.

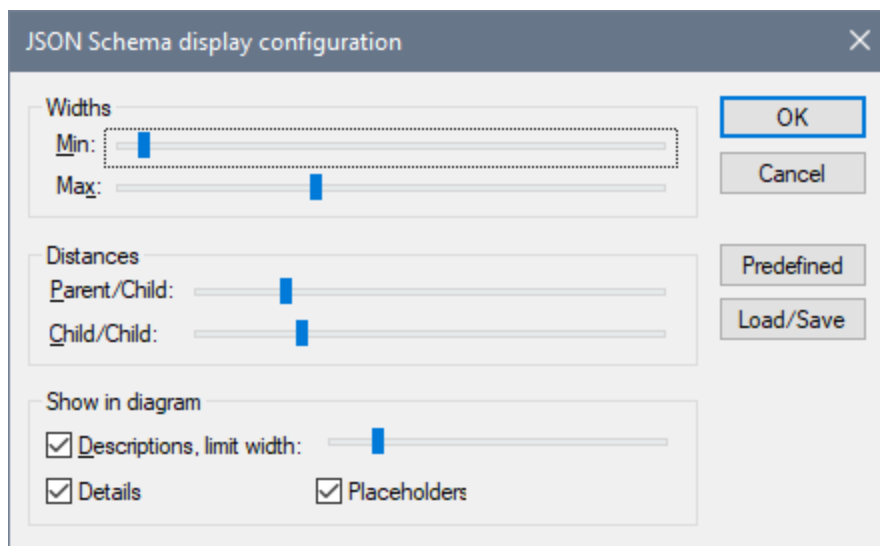

You can configure the following aspects of Design View:

- *Widths*: Two sliders determine, respectively, the minimum and maximum widths of boxes in Design View. Together they determine the allowed width of boxes.
- *Parent/child distances*: Sets the horizontal distance between each level in the hierarchy.
- *Child/child distances*: Sets the vertical distances between boxes.
- *Width of descriptions*: Sets the width of description lines. If text length exceeds this width, the text wraps to the next line.
- *Details display*: The details of definitions can be switched to display or not in the definitions' boxes by checking or unchecking this option. There is a corresponding toolbar icon.
- *Placeholders display*: Placeholders are items that have not yet been defined; they represent potential items. This option sets whether the display of placeholders is switched on or not. There is a corresponding toolbar icon. For example, the *Add Property* item in the screenshot below is a placeholder.

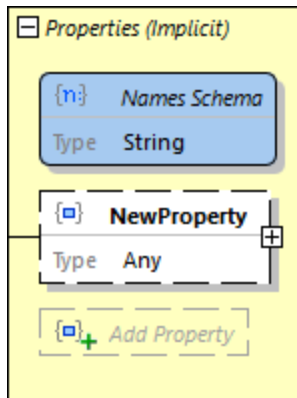

Note: The **Configure View** menu command is enabled only in the [Design View mode](#)⁵²³, which shows the detailed definition of an object. It is not available in [Definitions Overview Grid](#)⁵²³.

13.6.16 Generating JSON Schema Documentation

If a JSON schema is the active document, you can generate documentation for it by clicking the **Schema Design | Generate Documentation** command. You can output the documentation as an HTML, MS Word, or RTF file and specify the components you want to include. Related JSON components are hyperlinked in the generated documentation, allowing easy navigation.

Note: In order to generate documentation in MS Word format, you must have MS Word (version 2000 or later) installed.

Steps to generate JSON schema documentation

To generate documentation for a JSON schema file, do the following:

1. Make the JSON schema the active document.
2. Switch to Schema View.
3. Select the menu command **Schema Design | Generate Documentation**. This opens the JSON Schema Documentation dialog box (*screenshot below*).
4. Select the type of output you want to generate, HTML, MS Word, or RTF.
5. Select the specific components and details you want to include in the documentation, and set other options (*see JSON Schema Documentation Options below*).

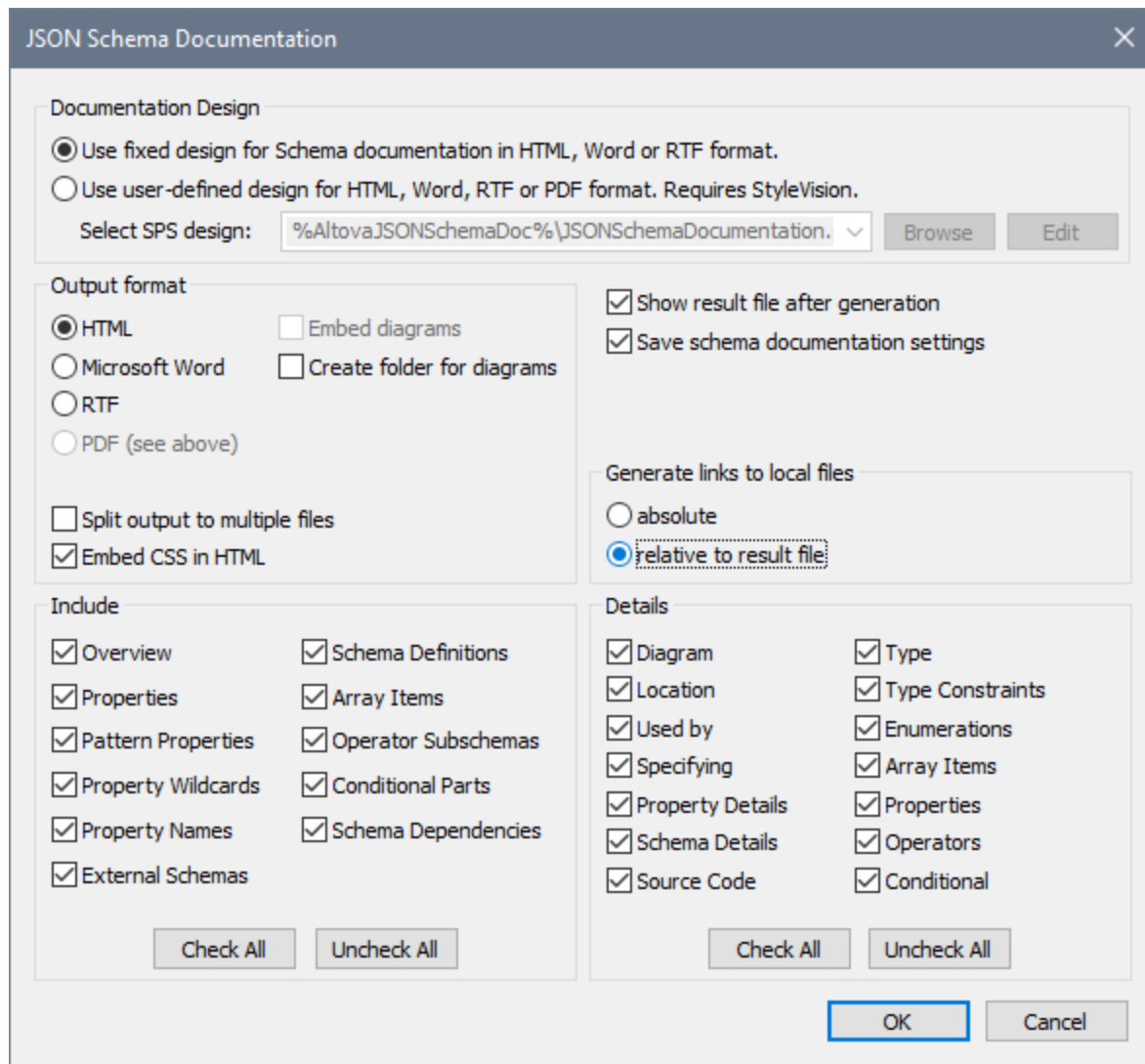

- Click **OK** and enter the name of the JSON schema documentation file in the Save As dialog box that appears.

JSON schema documentation options

You can select from among the following documentation options:

- The design template can be the built-in (fixed) XMLSpy design, or it can be a user-defined design that is saved in an SPS file. For a description of how to use a user-defined design, see the section [User-Defined Design](#)⁸⁹¹.
- The required format is specified in the Output Format pane: either HTML, Microsoft Word, or RTF. The documentation can be generated either as a single file or be split into multiple files. When multiple files are generated, each file corresponds to a component. What components are included in the output is specified using the check boxes in the *Include* pane.
- The *Embed Diagrams* option is enabled for the MS Word and RTF output options. When this option is checked, diagrams are embedded in the result file, either in PNG or EMF format. Otherwise diagrams

are created as PNG or EMF files, which are displayed in the result file via object links. When the output is HTML, all diagrams are created as document-external PNG files.

- In the *Include* pane, you select which items you want to include in the documentation. The *Overview* option lists all components, organized by component type, at the top of the file. If *Schema Definitions* is not selected, then all child components are disabled (that is, everything except *External Schemas*).
- The *Details* pane lists the details that may be included for each component. If *Schema Definitions* is not selected, then all details are disabled. Select the details you wish to include in the documentation.
- The *Show Result File* option is enabled for all three output options. When this option is checked, the result files are displayed in Browser View (HTML output), MS Word (MS Word output), and the default application for `.rtf` files (RTF output).

13.7 Validate JSON Documents

XMLSpy contains a JSON validation engine that can be invoked to do the following:

- *If a JSON schema is the active document:* Validates the JSON schema against the appropriate JSON Schema specification (for which no additional schema assignment is needed); the schema version is indicated by the `$schema` keyword; the validation can be carried out in any of the three views ([Text](#), [Grid](#), and [JSON Schema](#)).
- *If a JSON instance is the active document:* Validates the JSON instance against a JSON schema. The schema is assigned to the JSON instance as described below. JSON instance validation can be carried out in [Text View](#) and [Grid View](#).
- *If a JSON5 instance is the active document:* Validates the JSON instance against a JSON schema. The schema is assigned to the JSON5 instance as described below. JSON5 instance validation can be carried out in [Text View](#) and [Grid View](#).

Avro validation (Enterprise Edition only)

Avro data and Avro schema documents, as JSON documents, can be validated in [Text View](#) and [Grid View](#):

- *If an Avro data instance in JSON format is the active document:* Validates the Avro instance against an Avro schema. The schema is assigned to the instance as described below.
- *If an Avro schema is the active document:* Validates the Avro schema against the [Avro schema specification](#) (no schema assignment is needed); the validation can be carried out in [Text View](#) or [Grid View](#).

Assigning a JSON schema to a JSON instance

JSON instance documents can be validated against a JSON schema.

To set the JSON schema against which you want to validate a JSON or YAML document, do the following:

1. Make the JSON/YAML document the active document.
2. In the JSON tab of the Info window (*screenshot below*), click the arrow icon next to *Validation against schema*, and, in the menu that appears, click **Select JSON Schema**. (*Note that Avro support is available in XMLSpy Enterprise Edition only.*)

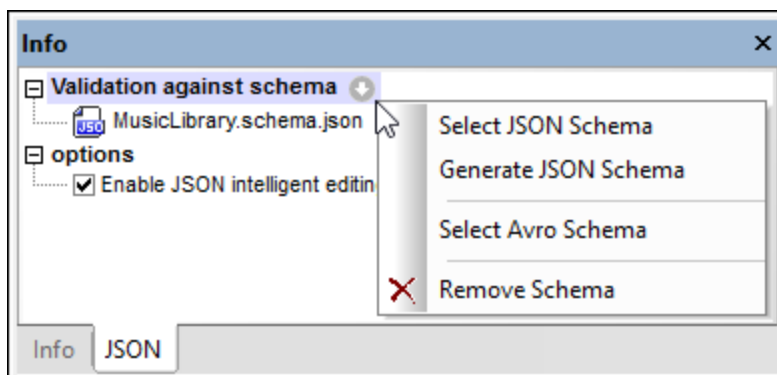

Note that the JSON schema assignment is not written into the JSON or YAML document, but entered in the Info window of XMLSpy. When you now validate the JSON or YAML document, the JSON schema file in the Info window will be the file used for validation.

To remove the assignment, select the command **Remove Schema** from the same menu (*see screenshot above*).

Note: If the JSON or YAML file is part of an XMLSpy project, then the JSON schema for validation can also be assigned via the [Project Properties](#)⁸⁴⁹ dialog (use the *Validate With* option in this dialog). If you then validate a project folder, all the JSON and YAML files in the project folder will be validated against the JSON schema. If you wish to run JSON and YAML validation separately, then we recommend that you put each document type in a separate project subfolder.

For information about generating a JSON schema from the JSON instance, see the section [Generating JSON Schema from a JSON Instance](#)⁵⁶⁹.

Validating instance and schema documents

Select the command **XML | Validate XML (F8)** or click the **Validate (F8)** icon  in the toolbar to validate the active JSON document (instance or schema). If an instance document is being validated, a schema document must be assigned to the instance (*see above*). Validation results are displayed in the [Messages window](#)¹¹³. Errors are also flagged in the line-numbering margin. If a smart fix is available for an error, then a light bulb icon is shown on the line that generates the error. When you place the mouse over the icon, a popup appears that lists available smart fixes. Select a fix to apply it immediately.

Note: The validation error indicators and smart fixes described above are refreshed only when the **XML | Validate (F8)** command is executed; they are not updated in the background. So, after correcting an error, you must run the **Validate (F8)** command again to make sure that the error has indeed been fixed.

To go to the schema document from the instance document, double-click the schema in the Info window (*see screenshot above*), or select the command **DTD/Schema | Go to Schema**. To go directly to the schema definition of a JSON keyword or object, select the keyword or object in the instance document and select **DTD/Schema | Go to Definition**.

You can also validate a [project folder](#)⁷¹⁴ containing JSON files by using the **Validate** command.

Validate on modification

The *Validate on Edit* mode is toggled on by default. When toggled on, well-formed checks and validation checks are carried out as you modify a document in JSON Grid View. For validation of a JSON document to be carried out (additional to well-formed checks), a JSON Schema must be assigned to the JSON document. Errors are shown by displaying erroneous text in red and flagging the location with a red exclamation mark. See [Validating JSON Documents](#)⁵⁶¹ for more information.

The *Validate on Edit* mode can be toggled on/off either (i) via the **XML | Validate on Edit**⁸⁶³ menu command, (ii) the **Validate on Edit** toolbar button, or (iii) via the *On Edit* option of the [Validation settings of the Options dialog](#)¹⁰⁴¹.

13.8 Insert JSON Fragments

You can insert JSON fragments from other applications and web pages. These fragments can be inserted in one of two ways:

- By using drag-and-drop to Text View or Grid View. If you drag-and-drop to Grid View, the [intelligent information available in drag overlays](#)¹⁷⁴ can help you decide where to drop the fragment.
- By using copy-and-paste to Text View or Grid View.

Example

The following example shows how a fragment can be added quickly and to the correct location in a JSON document.

1. The fragment that is highlighted below (from the JSON tutorial at w3schools.com) is selected. It is an array named `cars`.

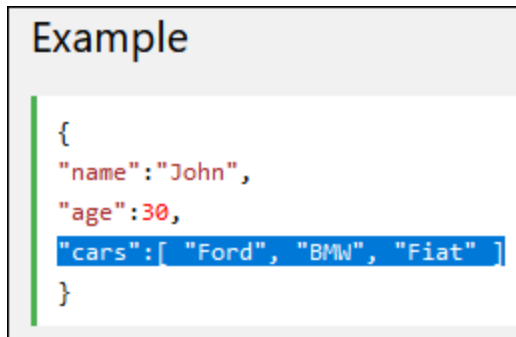

```
Example
{
  "name": "John",
  "age": 30,
  "cars": [ "Ford", "BMW", "Fiat" ]
}
```

2. The screenshot below shows the Grid View of a JSON document containing a similar `cars` array. When the fragment from the web page is dragged to the already existing `cars` array, a [drag overlay](#)¹⁷⁴ appears containing the information that the dragged JSON fragment will be dropped below the existing array as a new array named `cars`.

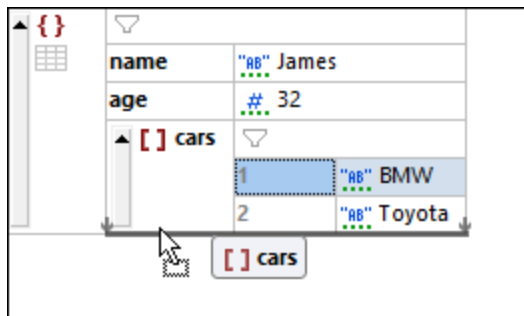

3. When the fragment is dropped, it is placed exactly where it is wanted (*screenshot below*).

The screenshot shows a JSON tree view in Altova XMLSpy. The root node is an object with the following structure:

- name: "James" (string)
- age: 32 (number)
- cars: [array of 2 objects]
- cars: [array of 3 objects]

The first 'cars' array contains two objects:

- 1: "BMW" (string)
- 2: "Toyota" (string)

The second 'cars' array contains three objects:

- 1: "Ford" (string)
- 2: "BMW" (string)
- 3: "Fiat" (string)

13.9 JSON Transformations with XSLT/XQuery

JSON maps, arrays, and objects can be targeted with **XPath/XQuery 3.1** expressions. As a result, JSON documents can be transformed with **XSLT 3.0**, **XQuery 3.1**, and **XQuery Update 3.0** documents by using the built-in engines of XMLSpy.

The following functionality is available:

- An active [JSON document can be queried with XPath/XQuery 3.1 expressions](#)⁵⁶⁵ from the [XPath/XQuery output window](#)¹¹⁵
- An active JSON document can be [transformed with a user-selected XSLT or XQuery file](#)⁵⁶⁶
- An active XSLT or XQuery document can be [executed on a user-selected JSON source file](#)⁵⁶⁶

These features are described below in more detail below. For information about constructing XQuery expressions for JSON documents, see the section [XQuery Expressions for JSON](#)⁵⁶⁷.

Note: You can try out JSON transformations by using the JSON, XSLT, and XQuery files in the *JSON Examples* folder of the *Examples* project located in your application folder: C:\Documents and Settings\\My Documents\Altova\XMLSpy2024\Examples\Examples.spp.

Querying a JSON document via the XPath/XQuery Window

JSON documents can be queried by entering an XPath/XQuery 3.1 query expression in the [XPath/XQuery output window](#)¹¹⁵ (see *screenshot below*). Select either the **XPath 3.1** icon or **XQuery 3.1** icon, and ensure that the window is in JSON evaluation mode (*explained below*).

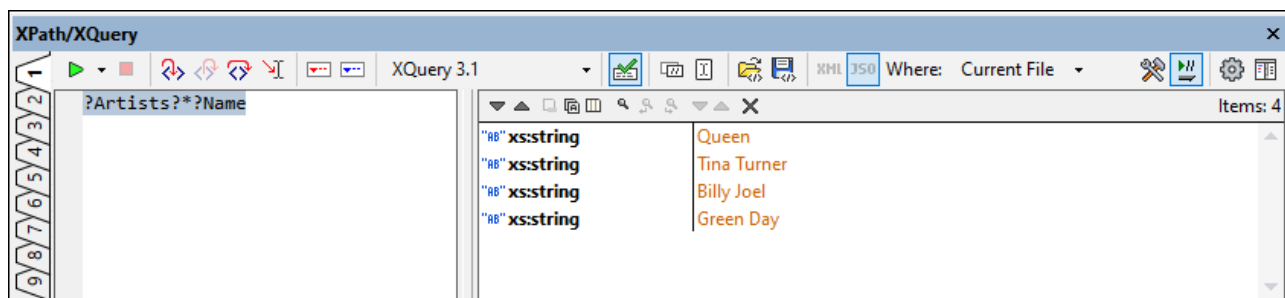

The information given below pertains to evaluations of JSON documents in JSON evaluation mode. (For an overview of the XPath/XQuery window and detailed information about its usage, see the section [Output Window: XPath/XQuery](#)¹¹⁵.)

JSON evaluation mode

JSON evaluation mode is described through these points:

- The XPath/XQuery window will be in either XML evaluation mode or JSON evaluation mode. Which mode is currently **active** is indicated by the active mode's button being highlighted. See the XML/JSON evaluation mode buttons in the screenshot above. In the screenshot, the window is in JSON evaluation mode.
- In the screenshot above, notice that the XML and JSON buttons are grayed out, indicating that they are **disabled**. When the buttons are disabled, their status—whether activated or deactivated—cannot be changed. Conversely, if the buttons are **enabled** (not grayed out), then the evaluation mode of the window can be changed.

- The *enabled/disabled* state of the XML/JSON evaluation mode buttons depends on the evaluation scope (the value of the *Where* field; see *screenshot above*). Evaluation-scope values are divided into two groups for the determination of the *enabled/disabled* state: (i) Single file (*Current file*), and (ii) Multiple files (*Open files, Project, Folder*).
- If, for the evaluation scope, a single file (*Current file*) is selected (*as in the screenshot above*), then the window's mode (JSON or XML) is determined on the basis of the [file's extension](#)¹⁰⁴³. Either the file is [JSON conformant](#)¹⁰⁴³, in which case JSON evaluation mode is **activated**; or the file is [not JSON conformant](#)¹⁰⁴³, and XML evaluation mode is switched on. Since the file type of the single file is known, the appropriate evaluation mode is activated, and both buttons are **disabled** so that the mode cannot be changed.
- If a multiple-files option (*Open files, Project, Folder*) is selected, then both evaluation mode buttons are **enabled**, and the user can select what mode to activate (JSON or XML). The default evaluation mode for a multiple-file scope is XML.
- In XML evaluation mode, [XML conformant files](#)¹⁰⁴³ will be processed and JSON files will be skipped.
- In JSON evaluation mode, [JSON conformant files](#)¹⁰⁴³ will be processed and XML files will be skipped.
- JSON expressions can also be queried in [Debug Mode](#)⁴²⁸.

Transforming a JSON document with XSLT/XQuery

To transform [an active JSON document](#)¹⁰⁷ with an XSLT 3.0, XQuery 3.1, or XQuery Update 3.0 document, do the following:

- *XSLT 3.0 transformation:* Click **XSL/XQuery | XSL Transformation**, browse for the XSLT 3.0 file, and click **OK**.
- *XQuery 3.1 or XQuery Update 3.0 transformation:* Click **XSL/XQuery | XQuery/Update Execution**, browse for the XQuery 3.1 or XQuery Update 3.0 file, and click **OK**.

The transformed document/s will be generated, and can be viewed directly in XMLSpy.

Note: [XSLT/XQuery Debugger](#)³⁹⁹ can be started from a JSON document, but breakpoints and tracepoints can be set in the XSLT or XQuery document only.

Providing a JSON source for an XSLT/XQuery document

To execute [an active XSLT or XQuery document](#)¹⁰⁷ on a JSON source file, do the following:

- *Active XSLT 3.0 document:* Click **XSL/XQuery | XSL Transformation**, browse for the JSON file, and click **OK**.
- *Active XQuery 3.1 or XQuery Update 3.0 document:* Click **XSL/XQuery | XQuery/Update Execution**, browse for the JSON file, and click **OK**.

The transformed document/s will be generated, and can be viewed directly in XMLSpy.

Note: [XSLT/XQuery Debugger](#)³⁹⁹ can be started from an XSLT or XQuery document and a JSON document can be assigned as input for the debugging session. However, breakpoints and tracepoints can be set in the XSLT or XQuery document only.

13.10 XQuery Expressions for JSON

XQuery 3.1 expressions for JSON

Since JSON data structures commonly use objects and arrays, it is the [XQuery 3.1 lookup operator](#) `?` that is used to locate nodes inside JSON objects (which are essentially maps from an XQuery perspective) and JSON arrays. This way of locating a node is different than how path expressions are written to locate nodes in XML documents. In these, the slash operator `/` is used to connect steps in a path expression (for example: `items/*`). In XQuery expressions for JSON, the slash operator is not used for locating nodes.

Examples of XQuery expressions for JSON

```
?items?*
```

Read this to mean: Lookup the child node `items` and then lookup all its children nodes. Note that `items` is expected to be a child node of the context node.

```
?Artists?1?Albums?2?Name
```

Read this to mean: Lookup the child node `Artists` and then lookup its first child node. Inside that node, lookup the child node `Albums` and then lookup its second child node. Now return the `Name` node of that second child node.

```
?Tracks?*[contains(?Writer, 'Brian')]
```

Read this to mean: Lookup the child node `Tracks` and then lookup all its children. While looking up the children, lookup each child's `Writer` node children, and select only those that contain the string `'Brian'`. Notice that there are three lookup operators in this expression. Each is used in a new step, where a nodeset must be looked up.

```
?Artists?*[?Name="Queen"]?Albums?*?Name
```

Read this to mean: Inside the root object, lookup the child node `Artists` and then lookup all its children that have `Name` node with a value of `"Queen"`. Inside these nodes, lookup all the child `Albums` nodes, and then their children. Inside these children, lookup (and return) the respective `Name` nodes. In the screenshot below, this expression is shown in the [XPath/XQuery Window](#)⁴¹⁹ together with the [JSON Grid View](#)⁵²⁰ representation of the target JSON document.

The screenshot displays the XMLSpy 2024 Professional Edition interface. The main window shows a JSON tree view of a 'Music Library'. The tree structure is as follows:

- Root: {}
 - Title: "AB" Music Library
 - Artists: []
 - {} 1
 - Name: "AB" Queen
 - Albums: []
 - {} 1
 - Name: "A Night at the Opera", "Genre": ["Rock"], "ReleaseDate": "1976-12-10" (highlighted)
 - {} 2
 - Name: "AB" A Day at the Races
 - Genre: ["Rock", "Pop"]
 - ReleaseDate: "AB" 1976-12-10
 - Label: "AB" EMI, Parlophone / Elektra, Hollywood
 - Tracks: [{"Title": "Tie Your Mother Down", "Duration": "04:48"}]

The XQuery 3.1 window at the bottom shows the following query and results:

```
?Artists?*[?Name="Queen"]?Albums?*?Name
```

Results (Items: 2):

- xs:string "A Night at the Opera"
- xs:string "A Day at the Races"

13.11 Generate JSON Schema from JSON Instance

XMLSpy can generate a JSON schema from a JSON instance document (including from JSON5 instances). This feature is very useful since it quickly provides you with a schema based on an already existing JSON instance, and saves you the trouble of manually creating a schema from scratch. You can then modify or extend the generated schema according to your requirements.

Generating the JSON schema

You can generate a JSON schema from a JSON instance in one of these ways:

- *DTD/Schema menu:* Make the JSON instance document the active document. Select the menu command **DTD/Schema | Generate DTD/Schema**.
- *JSON Info window:* Make the JSON instance document the active document. In the JSON tab of the Info window (*screenshot below*), click the Arrow icon next to *Validation against schema* and, in the dropdown menu that appears, select **Generate JSON Schema**.

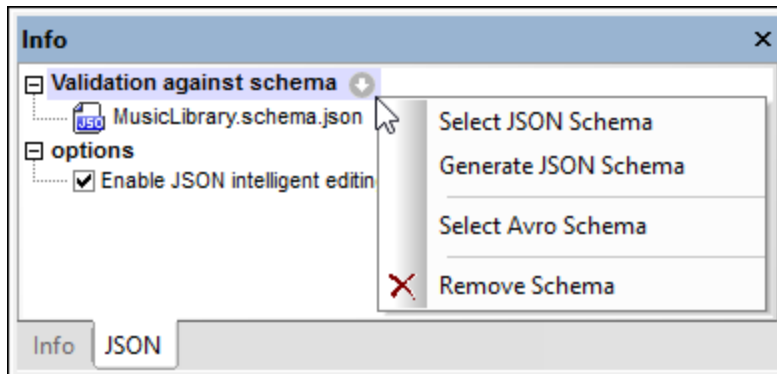

In both cases, the Generate JSON Schema dialog appears (*screenshot below in next section*). Do the following:

1. Modify the settings as you want (*see below for details*) and click **OK** when done.
2. You will be prompted to provide a path and filename for the generated JSON schema. Enter these.
3. On clicking **Save**, the JSON schema will be generated and becomes the active document.

In the JSON instance document, the generated schema file will be assigned as the schema to use for validation (see the Info window; *screenshot above*); any previous assignment will be overwritten. To change the assignment, use the **Select JSON Schema** command of the JSON Info window's dropdown menu (*screenshot above*). For more information about JSON instance validation, see [Validating JSON Documents](#)⁵⁶¹.

Settings for JSON schema generation

You can specify options for JSON schema generation in the Generate JSON Schema dialog (*screenshot below*). See the previous section for information about how to access this dialog.

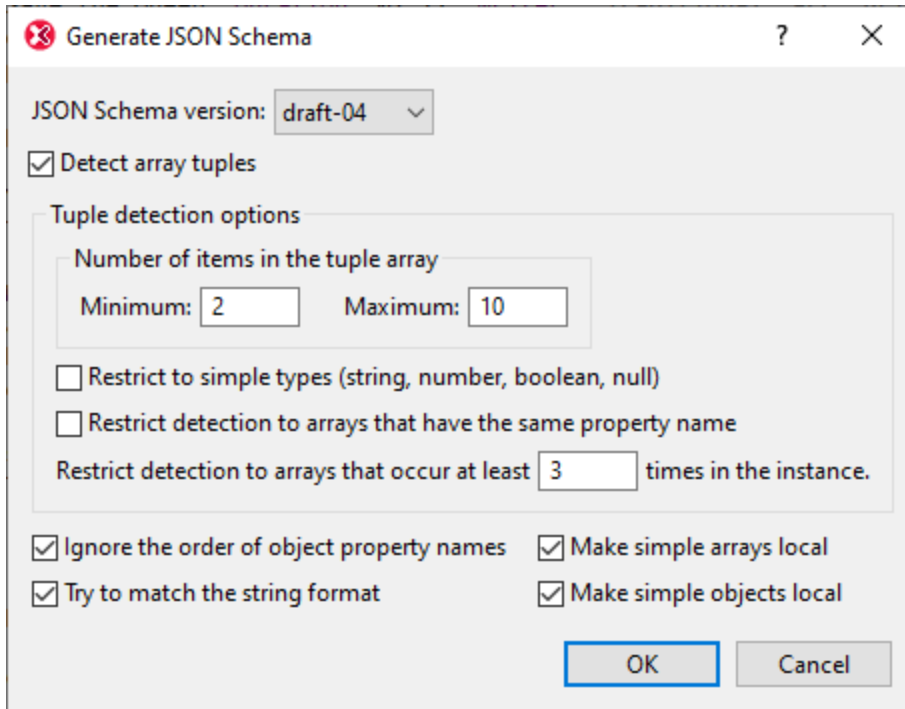

Detect array tuples

An array tuple is the sequence of items in an array. For example, the following array has a tuple with three items: `[1, 2, "abc"]`. For the validation of arrays, the schema can specify whether the order and datatype of array (tuple) items are to be considered or not. If the *Detect Array Tuples* option is checked (see screenshot above), then the order and datatype of items will be detected. Based on what is detected, a corresponding definition will be created in the schema. The options for this setting are as follows:

- *Number of tuple items:* A minimum and maximum number of tuple items can be specified. If a tuple in the instance has an item-count within this range, then this array will be detected and defined.
- *Simple types only:* Only tuples that have simple-type items (the atomic types `string`, `number`, `integer`, `boolean`, and `null`) are to be considered for detection.
- *Identically named arrays:* Only arrays that are defined as values of properties that have the same name are considered for detection. For example, in the following JSON data fragment, the arrays marked with red-shaded brackets are all values of properties named `a1` (shaded in blue): `{ "object1": [{ "a1": [1, 2, "abc"] }, { "a1": [3, 4, "def"] }, { "a1": [5, 6, "ghi"] }] }`.
- *Minimum number of arrays:* A minimum number of arrays for enabling array detection can be specified.

Other settings

- *Ignore order of object property names:* If unselected, the order of an object's properties is checked and recreated as closely as possible. Otherwise, the order is not checked.
- *Try to match the string format:* The schema can specify that string datatypes must have a particular [format](#). If this option is selected, then XMLSpy will try to detect the string format and add a format definition for strings wherever possible.
- *Make simple arrays local:* A simple array is one in which all items are of the same simple datatype. If selected, all simple arrays will be defined locally in the schema, instead of using global definitions that are referenced locally.

- *Make simple objects local:* A simple object is one in which all property values are of the same simple datatype. If selected, all simple objects will be defined locally in the schema, instead of using global definitions that are referenced locally.

Note: After the JSON schema has been generated, you can make local definitions of individual objects and arrays global, and vice versa. For more information, see the section [Global and Local Definitions](#)⁵³⁰.

13.12 Generate JSON Instance from JSON Schema

You can generate a JSON instance document from a JSON schema. Make the JSON schema the active file in Text View, and click the [DTD/Schema | Generate Sample XML/JSON File](#)⁸⁷⁹. Note that this command generates a JSON document, not a JSON5 document.

13.13 Convert between JSON and XML

The following conversion options are available:

- [Convert XML Instance to JSON](#)⁹⁸⁴: When an XML instance document is the active document, you can select whether to generate a JSON or JSON5 instance document. Use the command [Convert | Convert XML Instance to/from JSON/YAML](#)⁹⁸⁴.
- [Convert JSON Instance to XML](#)⁹⁸⁴: When a JSON/JSON5 instance document is the active document, an XML instance document is generated from the JSON instance by clicking [Convert | Convert XML Instance to/from JSON/YAML](#)⁹⁸⁴.
- [Convert XML Schema to JSON Schema](#)⁹⁸⁷: When an XML Schema document is the active document, a JSON schema document is generated from the XML Schema by clicking [Convert | Convert XML Schema to/from JSON Schema](#)⁹⁸⁷.
- [Convert JSON Schema to XML Schema](#)⁹⁸⁷: When a JSON schema document is the active document, an XML Schema document is generated from the JSON schema by clicking [Convert | Convert XML Schema to/from JSON Schema](#)⁹⁸⁷.

All these conversions are enabled in both Text View and Grid View. Click the links above to see descriptions of the respective functionality.

14 YAML

YAML stands for YAML Ain't Markup Language. It is a popular data serialization language that is a superset of JSON. XMLSpy provides a Text View of YAML documents as well as other features such as YAML document validation against JSON schemas and conversion of YAML documents to and from the JSON format.

This section describes the various YAML features of XMLSpy and is organized into the following topics:

- [Create and Validate YAML Documents](#) ⁵⁷⁵
- [YAML Text View](#) ⁵⁷⁷
- [Generate JSON Schema from YAML Document](#) ⁵⁷⁸
- [Generate YAML Document from JSON Schema](#) ⁵⁸¹
- [Convert between YAML and JSON](#) ⁵⁸²

14.1 Create and Validate YAML Documents

Create YAML documents

In XMLSpy, the `.yaml` and `.ym1` file extensions have been defined as YAML file extensions. If you wish to add other file extensions for your YAML documents, then do this in the [File Types section of the Options dialog](#)¹⁰⁴³. XMLSpy will treat documents with YAML file extensions as a YAML document and will enable XMLSpy's YAML viewing and editing features for these documents.

When a new YAML file is created with [File | New](#)⁷⁸², you will be asked if you want to assign a JSON schema to the YAML file.

- If you assign a JSON schema (see "Validate YAML documents" below), then the new file will be created with a sample YAML document and displayed in a new window.
- If you choose not to assign a JSON schema, then an empty YAML document is created in a new window. If you subsequently assign a JSON schema to the *empty* YAML document, then a sample YAML document based on the JSON schema is generated in the empty YAML document.

Validate YAML documents

YAML documents can be validated against JSON Schemas.

Set the JSON Schema for validation

To set the JSON schema against which you want to validate a JSON or YAML document, do the following:

1. Make the JSON/YAML document the active document.
2. In the JSON tab of the Info window (screenshot below), click the arrow icon next to *Validation against schema*, and, in the menu that appears, click **Select JSON Schema**. (Note that Avro support is available in XMLSpy Enterprise Edition only.)

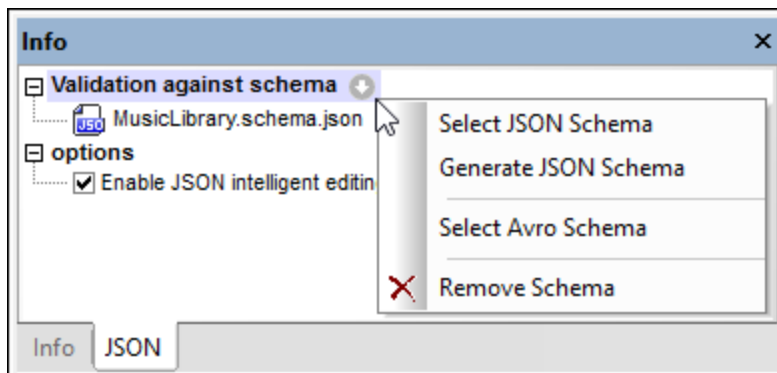

Note that the JSON schema assignment is not written into the JSON or YAML document, but entered in the Info window of XMLSpy. When you now validate the JSON or YAML document, the JSON schema file in the Info window will be the file used for validation.

To remove the assignment, select the command **Remove Schema** from the same menu (see screenshot above).

Note: If the JSON or YAML file is part of an XMLSpy project, then the JSON schema for validation can also be assigned via the [Project Properties](#)⁸⁴⁹ dialog (use the *Validate With* option in this dialog). If you then validate a project folder, all the JSON and YAML files in the project folder will be validated against

the JSON schema. If you wish to run JSON and YAML validation separately, then we recommend that you put each document type in a separate project subfolder.

For information about generating a JSON schema from a YAML document, see [Generate JSON Schema from YAML Document](#)⁵⁷⁸.

Validate the document

After setting the JSON schema for validation, validate the document by selecting the command [Validate \(F8, XML | Validate\)](#)⁸⁵⁷. If you want to be informed about the validity of your document as you type, toggle on the [Validate on Edit](#)⁸⁶³ feature ([XML | Validate on Edit](#)⁸⁶³). Validation results will be highlighted in the document and details will be displayed in the [Messages window](#)¹¹³. You can click an error in the Messages window to go to that error in the document.

14.2 YAML Text View

Text View provides a number of YAML editing features, from pretty-printing to document validation while editing. These features are described below.

Note: YAML document structure in Text View is denoted with indentation, which should be set with spaces, not tabs.

Pretty-printing, font colors, and display

Pretty-printing formats the YAML document with hierarchical indentation (see *screenshot below*). You can define pretty-printing options in the Options dialog ([Tools | Options | Pretty-printing](#)¹⁰⁴⁸). The document text is marked in different colors according to their syntax. Font colors are set in the Options dialog ([Tools | Options | Pretty-printing](#)¹⁰⁴⁸).

```

1  Title: Music Library
2  Artists:
3    - Name: Queen
4      Albums:
5        - Name: A Night at the Opera
6          Genre: [ Rock ]
7          ReleaseDate: 1975-11-21
8          Label: EMI / Hollywood Records
9          Tracks: ...
22       - Name: A Day at the Races
23         Genre: [ Rock, Pop ]
24         ReleaseDate: 1976-12-10
25         Label: EMI, Parlophone / Elektra, Hollywood
26         Tracks:
27           - { Title: Tie Your Mother Down, Duration: 04:48, Writer: Brian May }
28           - { Title: You Take My Breath Away, Duration: 05:09, Writer: Freddie Mercury }
29           - { Title: Long Away, Duration: 03:34, Writer: Brian May }

```

Other useful features of the YAML Text View are (i) line numbers in the line number margin and (ii) text-folding nodes in the folding margin. The text-folding nodes can be collapsed/expanded to better navigate and view the document. Both margins (line numbers and text folding) can be set to be shown or hidden in the Text View Settings dialog ([View | Text View Settings](#)⁹⁹⁵); this dialog can also be accessed via the [pretty printing options](#)¹⁰⁴⁸.

Node locator expressions in YAML documents

To get the XPath/XQuery location expression of a node in the YAML document, click inside the node and then select the command [Edit | Copy XPath](#)⁸⁰⁷. The XPath/XQuery expression will be copied in JSON format to the clipboard. Press **Ctrl+V** to paste the locator expression to any text entry field.

For example, the following expression locates the title of the first track of the second album of the first artist in a YAML document:

```
?Artists?1?Albums?2?Tracks?1?Title
```

For more information about XPath/XQuery expressions in JSON format, see [XQuery Expressions for JSON](#)⁵⁶⁷.

14.3 Generate JSON Schema from YAML Document

XMLSpy can generate a JSON schema from a YAML document. This feature is very useful because it quickly provides you with a JSON schema based on an already existing YAML document, and saves you the trouble of manually creating a schema from scratch. You can then modify or extend the generated schema according to your requirements.

Generating the JSON schema

You can generate a JSON schema from a YAML document in one of these ways:

- *DTD/Schema menu*: Make the YAML document the active document. Select the menu command **DTD/Schema | Generate DTD/Schema**.
- *JSON Info window*: Make the YAML document the active document. In the JSON tab of the Info window (*screenshot below*), click the Arrow icon next to *Validation against schema* and, in the dropdown menu that appears, select **Generate JSON Schema**.

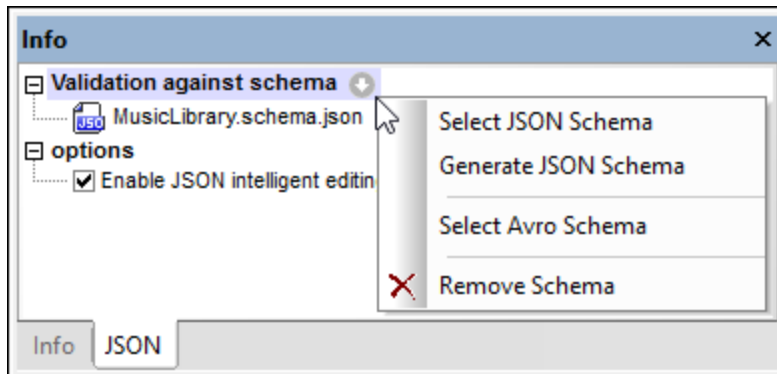

In both cases, the Generate JSON Schema dialog appears (*screenshot below in next section*). Do the following:

1. Modify the settings as you want (*see below for details*) and click **OK** when done.
2. You will be prompted to provide a path and filename for the generated JSON schema. Enter these.
3. On clicking **Save**, the JSON schema will be generated and becomes the active document.

In the YAML instance document, the generated schema file will be assigned as the schema to use for validation (see the Info window; *screenshot above*); any previous assignment will be overwritten. To change the assignment, use the **Select JSON Schema** command of the JSON Info window's dropdown menu (*screenshot above*). For more information about YAML document validation, see [Validating YAML Documents](#)⁵⁷⁵.

Settings for JSON schema generation

You can specify options for JSON schema generation in the Generate JSON Schema dialog (*screenshot below*). See the previous section for information about how to access this dialog.

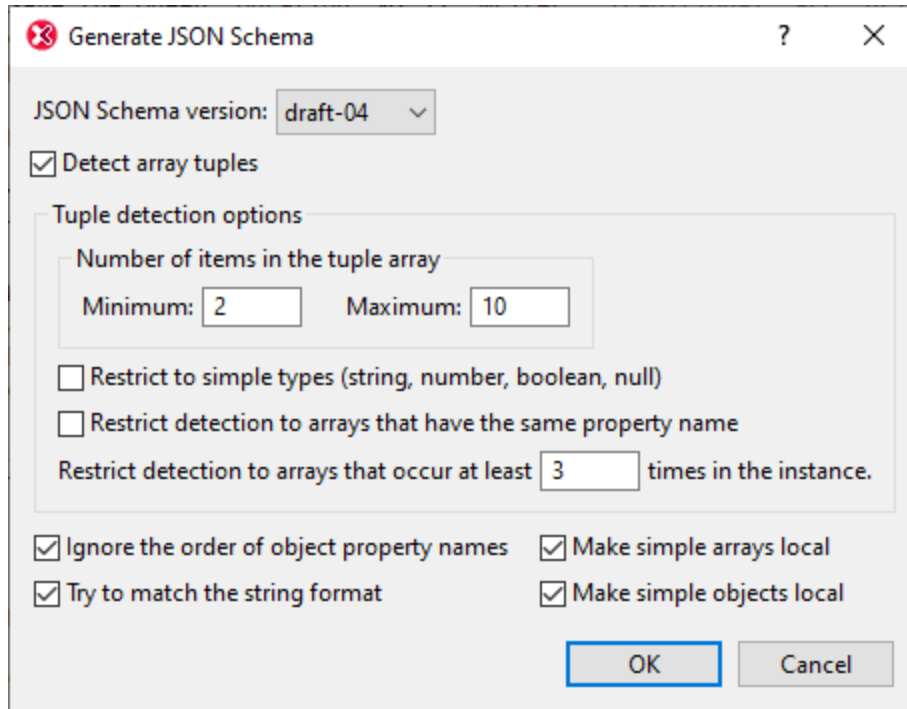

Detect array tuples

An array tuple is the sequence of items in an array. For example, the following array has a tuple with three items: `[1, 2, "abc"]`. For the validation of arrays, the schema can specify whether the order and datatype of array (tuple) items are to be considered or not. If the *Detect Array Tuples* option is checked (see screenshot above), then the order and datatype of items will be detected. Based on what is detected, a corresponding definition will be created in the schema. The options for this setting are as follows:

- *Number of tuple items:* A minimum and maximum number of tuple items can be specified. If a tuple in the instance has an item-count within this range, then this array will be detected and defined.
- *Simple types only:* Only tuples that have simple-type items (the atomic types `string`, `number`, `integer`, `boolean`, and `null`) are to be considered for detection.
- *Identically named arrays:* Only arrays that are defined as values of properties that have the same name are considered for detection. For example, in the following JSON data fragment, the arrays marked with red-shaded brackets are all values of properties named `a1` (shaded in blue): `{ "object1": [{ "a1": [1, 2, "abc"] }, { "a1": [3, 4, "def"] }, { "a1": [5, 6, "ghi"] }] }`.
- *Minimum number of arrays:* A minimum number of arrays for enabling array detection can be specified.

Other settings

- *Ignore order of object property names:* If unselected, the order of an object's properties is checked and recreated as closely as possible. Otherwise, the order is not checked.
- *Try to match the string format:* The schema can specify that string datatypes must have a particular [format](#). If this option is selected, then XMLSpy will try to detect the string format and add a format definition for strings wherever possible.
- *Make simple arrays local:* A simple array is one in which all items are of the same simple datatype. If selected, all simple arrays will be defined locally in the schema, instead of using global definitions that are referenced locally.

- *Make simple objects local:* A simple object is one in which all property values are of the same simple datatype. If selected, all simple objects will be defined locally in the schema, instead of using global definitions that are referenced locally.

Note: After the JSON schema has been generated, you can make local definitions of individual objects and arrays global, and vice versa. For more information, see the section [Global and Local Definitions](#)⁵³⁰.

14.4 Generate YAML Document from JSON Schema

You can generate a YAML document from a JSON schema. Make the JSON schema the active file in Text View, and click the [DTD/Schema | Generate Sample XML/JSON File](#)⁸⁷⁹. Note that this command generates a JSON document, not a JSON5 document.

14.5 Convert between YAML and JSON/XML

You can convert a YAML document to a JSON instance and vice versa. Make the YAML file you want to convert the active file and select the menu command [Convert | Convert JSON to/from YAML](#)⁹⁹⁰. The active document will be converted into a document of the opposite file format. The new file will be opened in a new window, from where you can save it to file.

You can also convert a YAML document to an XML instance and vice versa. Make the YAML file you want to convert the active file and select the menu command [Convert | Convert XML Instance to/from JSON/YAML](#)⁹⁸⁴. The active document will be converted into a document of the opposite file format. The new file will be opened in a new window, from where you can save it to file.

Note: These commands are also available in the context menu of [XMLSpy project](#)⁷¹⁴ folders and files. When used on a project folder, the command allows you to batch convert all the JSON, XML, and YAML files in the folder to the other format.

15 HTTP

HTTP (Hypertext Transfer Protocol) is the protocol (or set of rules) that defines how files (text, images, audio, video, and other multimedia files) are transmitted over the Internet. Every web server runs a program (known as a daemon) that continuously waits for HTTP requests and handles each as it arrives. For example, when you visit a website's home page, your browser sends an HTTP command to the website's web server that requests the download of the home page; the server's HTTP daemon receives the request and sends the requested page. One significant property of HTTP bears noting: that it is *stateless*, which means that each HTTP command is carried out independently, without any reference to previous or following commands.

In XMLSpy, you can test HTTP commands in the [HTTP output window](#)¹¹⁶ (*screenshot below*). Here you can create and send an HTTP request to a web server, and receive and check the response.

Parts of the HTTP output window

The HTTP output window has nine tabs (*see screenshot below*). You can store a separate request in each tab, and switch between tabs. After creating a request in the window, you can send the request by clicking the **Send** button. The response is displayed directly in the window.

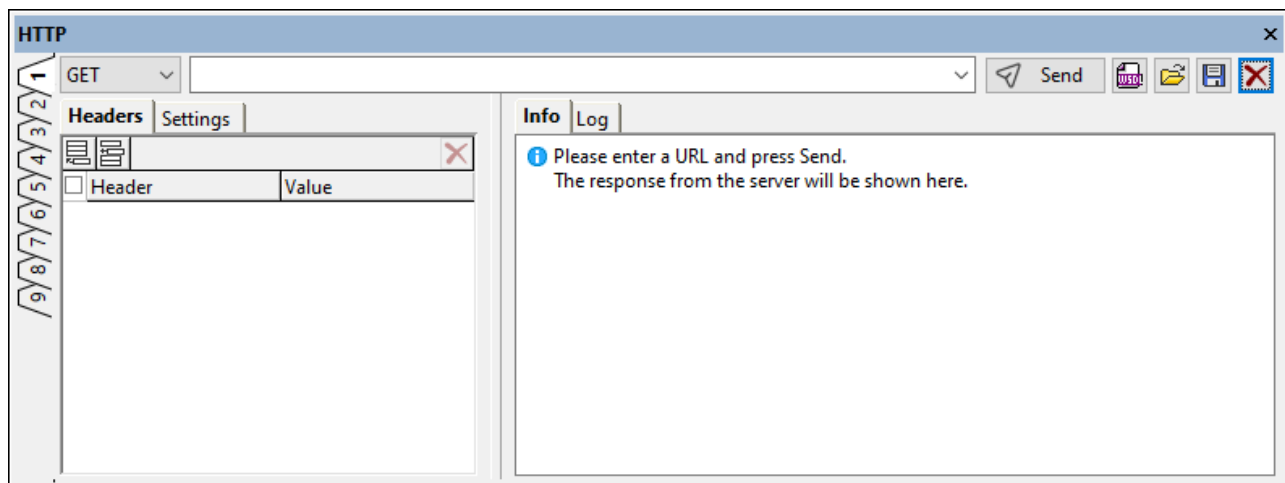

The window consists of the following parts:

- At the top: (i) a combo box in which to select the HTTP method you want to use; (ii) an entry field for the URL of the web server; (iii) buttons related to the execution of HTTP requests (**Send**, **Import**, and **Reset**).
- A left-hand pane for [creating the request](#)⁶⁸⁴.
- A right-hand pane for displaying information and logging information about the request.

How the HTTP output window works is described in the sub-sections of this section.

15.1 Sending the Request

You can send an HTTP request in the HTTP output window (*screenshot below*). A request is defined in the **left-hand pane of the window**. For each of the nine tabs of the window you can define a different request, with each request consisting of: (i) the [HTTP method](#)⁵⁸⁵ of the request and the target URL (defined in the top part of the dialog); (ii) the HTTP headers of the request (in the *Headers* tab); (iii) connection settings (in the *Settings* tab); and (iv) in the case of the [POST and PUT methods](#)⁵⁸⁵, the HTTP message body (in the *Body* tab; not shown in the screenshot below). You can revert a request to the empty state by clicking **Reset** (located at the top right of the window).

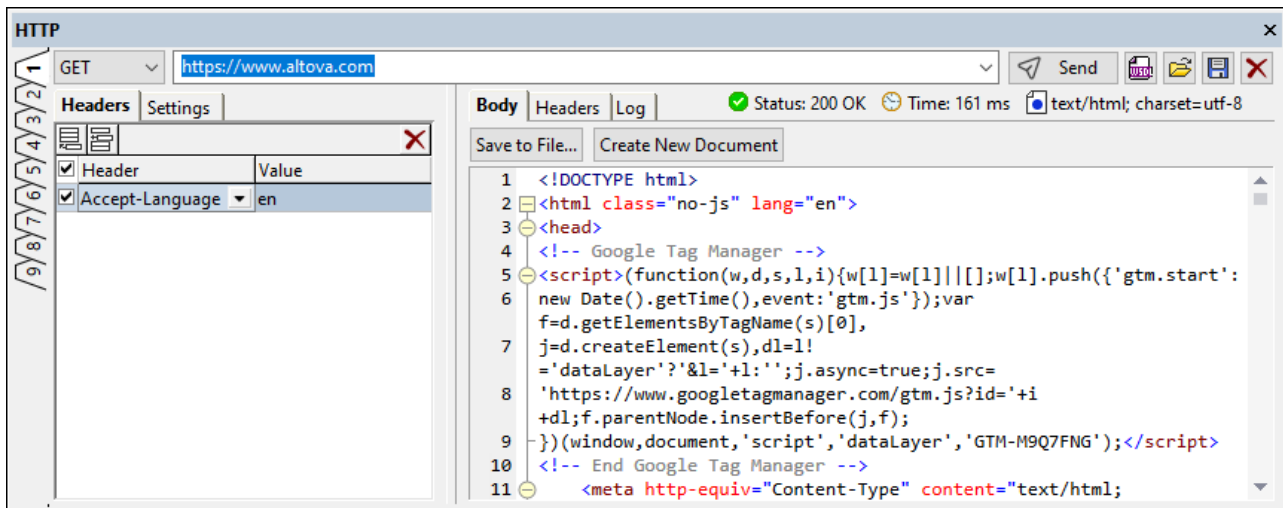

To send an HTTP request, do the following:

1. In the combo box at top left (see *screenshot*) select an HTTP method (**GET**, **POST**, **PUT**, **DELETE**, **HEAD**, or **OPTIONS**).
2. Enter the URL of the target web page (for example, `https://www.altova.com`. You can also enter just `altova.com`; the `https://` part of the URL will be completed for you).
3. In the *Headers* tab, you can specify [HTTP header values](#) (see *screenshot above*). You can select or enter an header, and then enter its value. (For a list of HTTP 1.1 headers, see [here](#).) Use the **Insert**, **Append**, and **Delete** icons in the tab's toolbar to add or delete headers. Instead of deleting a header, you can deactivate a header by unchecking the *Activate* check box to the left of the header's name; this will save you the trouble of having to re-enter a deleted header if you ever want to use it later. Also see the section [The Accept Header](#)⁵⁹³. (If you set a value for any header that would be added automatically at send-time, then the value you enter will be used instead of the value that would have been automatically added.)
4. If you are sending a **POST** or **PUT** request, a *Body* tab will become available in addition to the *Headers* and *Settings* tabs. How to create the body of a **POST** or **PUT** request is described in the section [The body of POST and PUT requests](#)⁵⁸⁵ below.
5. You can specify timeouts and security settings in the *Settings* tab. For a description of this tab, see [Settings for the HTTP request](#)⁵⁸⁷ below.
6. Click **Send** (located at the top right side of the window) to send the request.
7. If you wish to revert to the tab's empty state, click **Reset**. The following happens: (i) The method to use is reset to the first method in the dropdown list of the combo box (which is **GET**); (ii) the current URL entry is removed; (iii) All header, setting, and body definitions are removed.

8. You can save an HTTP request as a `.http_request` file. The request can subsequently be loaded from this file.

Note: You can also (i) import a request from a WSDL or WADL file into the HTTP output window via the window's [Create HTTP Request](#) ⁵⁸⁹ button, or (ii) load an HTTP request directly from a `.http_request` file.

Note: The request is sent in UTF-8 encoding. Any other encoding is converted to UTF-8, and the UTF-8 data is sent.

HTTP methods

The following HTTP methods are supported:

GET

The **GET** method requests the resource located at the specified URL. You can also add a query to the URL; for example: `http://www.altova.com?name1=value1&name2=value2`. The resource is returned in a message that contains a header and a body.

HEAD

The **HEAD** method is identical to the **GET** request, but returns no message body, only a message header containing meta information about the resource located at the specified URL.

POST

The **POST** method is used to update an existing resource located at the specified URL, or to create a new resource at the specified URL. The data to be submitted to the resource is placed in the body of the HTTP request; see [The body of POST and PUT requests](#) ⁵⁸⁵ for information about how to do this.

PUT

The **PUT** method is used to create a new resource at the specified URL. The data to be submitted to the resource is placed in the body of the HTTP request; see [The body of POST and PUT requests](#) ⁵⁸⁵ for information about how to do this.

DELETE

The **DELETE** method deletes the resource located at the specified URL.

OPTIONS

The **OPTIONS** method returns a list of the HTTP methods that the server supports.

The body of POST and PUT requests

For **POST** and **PUT** requests, an additional *Body* tab becomes available, in which the body of the **POST** or **PUT** request can be specified (see screenshot below). The *Body* tab has two modes: **Editor mode** and **File mode**. You can switch between these two modes via toolbar buttons at the top left of the *Body* tab (see screenshot). In Editor mode (shown selected in the screenshot below), you can edit the HTTP request directly in the pane, whereas in File mode you can select a file that contains the body of the HTTP request.

The *Content Type* field enables you to specify the **Content-Type** header of the request. The combo box options of this field are different for each mode (Editor and File). You can select from the available combo box options or enter a MIME type. Note that the value specified in this field overrides any **Content-Type** header that might be specified in the *Headers* tab or *Body* tab.

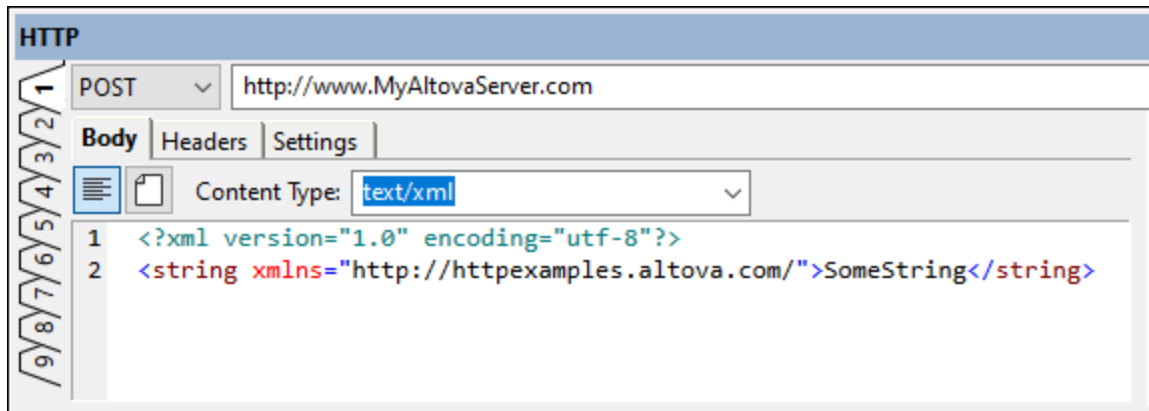

Editor mode

The style of the editor depends on the selected content type:

- For the `text/plain`, `text/xml`, `application/xml`, and `application/json` content types: A text editor that provides intelligent editing features such as syntax coloring for XML and JSON documents and line-numbering. The screenshot above shows the editor for the `text/xml` content type. The body of the request is entered in the editor. The content-type of the request is specified in the *Content Type* field and cannot be overridden by entries elsewhere in the request.
- For the `application/x-www-form-urlencoded` content type: The editor is a grid view (*screenshot below*) in which each new line represents a name–value pair in the body of the request.

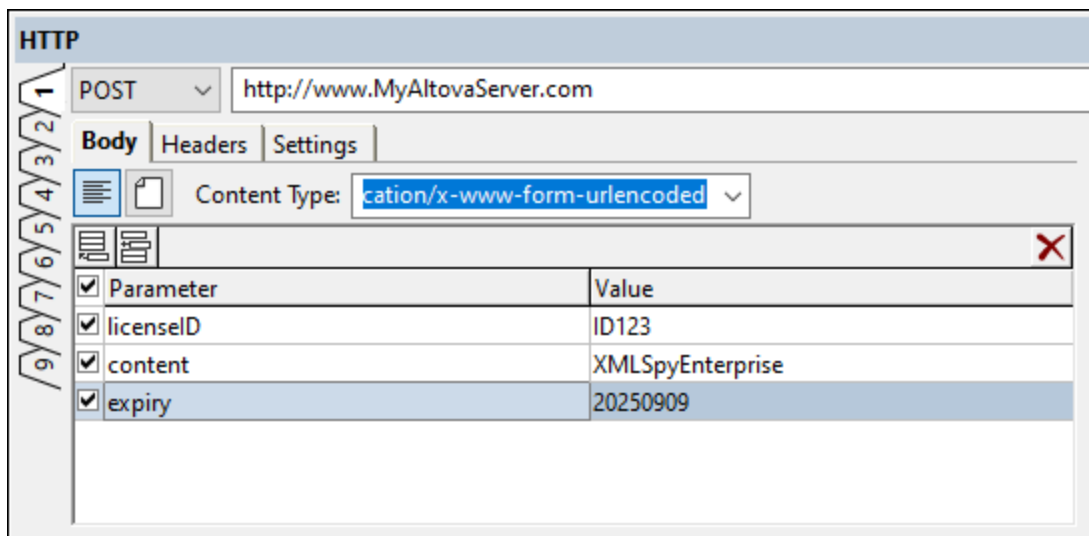

File mode

In File mode (*screenshot below*), the body of the request will be the contents of the selected file. This file can be either the file that is currently active in the Main Window (*Current file* option) or an external file that can be browsed for.

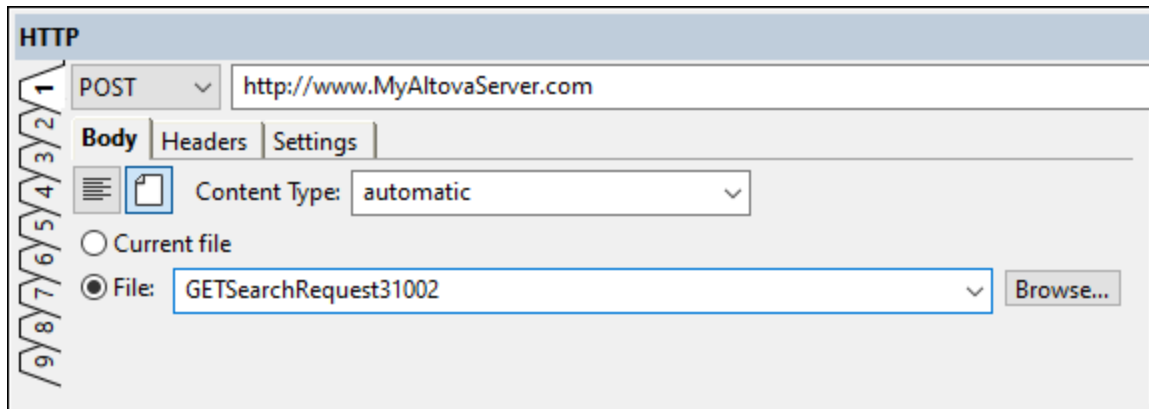

To switch to File mode, select the **File** icon near the top left of the *Body* tab (see *screenshot above*). To enable the content type of the body to be determined automatically, select *automatic* in the *Content Type* field. Automatic determination of the the content type is based on the file's extension. If you enter a content type, the request will be sent with the content type you enter; in this case, you must ensure that the content type is the correct one.

The headers and settings of the request can be specified in the same way as for other requests (that is, in the *Headers* tab and *Settings* tab, respectively).

Settings for the HTTP request

In the *Settings* tab of the HTTP output window (*screenshot below*) you can define (i) connection settings, (ii) proxy settings, and (iii) the security settings of a request. Note that you can define settings separately for each of the window's nine tabs. The screenshot below shows the settings for an HTTPS URL.

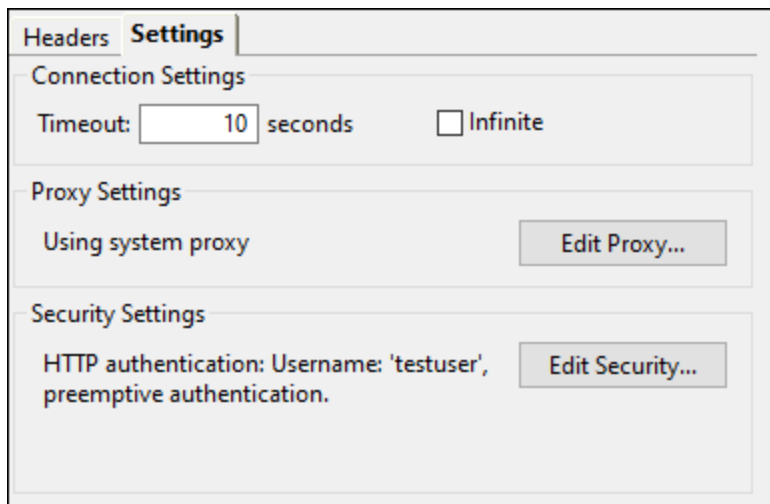

Connection Settings

You can specify the amount of time in seconds that XMLSpy will try to make a connection with the web server. If this amount of time is reached without a connection being made, then you will get **I/O Error 28: Timeout was reached**. If you wish to not specify a timeout period, then check the *Infinite* check box.

Proxy Settings

Provides a summary of the current proxy settings and a button to open the [Proxy Settings section of the Options dialog](#)¹⁰⁷⁷.

Security Settings

Click **Edit** to edit the security settings of a request. The HTTP Security Settings dialog (*screenshot below*) will be displayed. Here you can specify HTTPS security settings and set the HTTP authentication credentials for the request being made via that tab. If the request's target web server does not use SSL, then only the HTTP authentication credentials will be used. If the target web server uses SSL, then both the HTTPS security settings as well as the HTTP authentication credentials will be used.

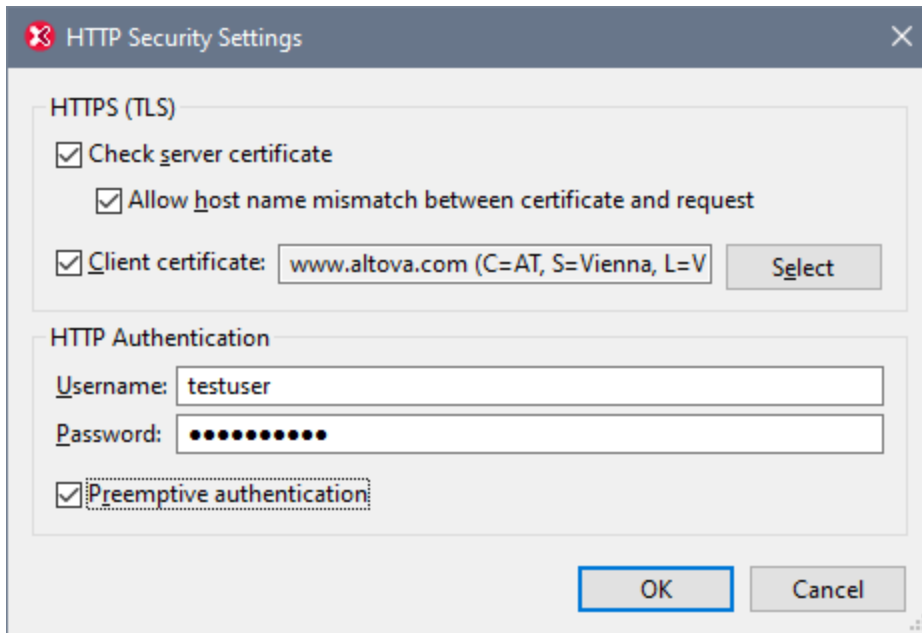

- *HTTPS security settings:* By default, the *Check server certificate* option will be checked, and you can specify whether the host name in the request may be different than the host name in the certificate. If you are targeting an Intranet URL (say, in your company network), then a client certificate (typically located in your local certificate store) can be used to verify a certificate on the Intranet server.
- *HTTP authentication:* Some requests to a server might require user authentication. For such cases, you can enter a user name and password here. Now, when authentication is required by the server, it will be supplied automatically. Otherwise, you might be prompted for it after the connection to the server is made. When the initial request to the server contains the authentication information, this process is referred to as preemptive authentication. If this is required by the server, select the *Preemptive authentication* option.

15.2 Importing a Request to Send

In the [HTTP output window](#)⁵⁸³, you can import a request from a WSDL 1.1, WSDL 2.0, or [Web Application Development Language \(WADL\)](#) file, and then send it. This is done by using XMLSpy's WSDL/WADL Import Wizard. The wizard opens a WSDL or WADL file, selects a request from one of the file's WSDL endpoints or WADL resources, enables you to modify the editable parameters of the request, and then imports the request into the [HTTP output window](#)⁵⁸³. Do this as follows:

1. In the [HTTP output window](#)⁵⁸³, click the **Import** button to start the WSDL/WADL Import Wizard.
2. In the files-selection dialog that appears, browse for the WSDL or WADL file that contains the request you want to import, and click **OK**. This starts the Import WSDL/WADL Wizard (*screenshot below*).

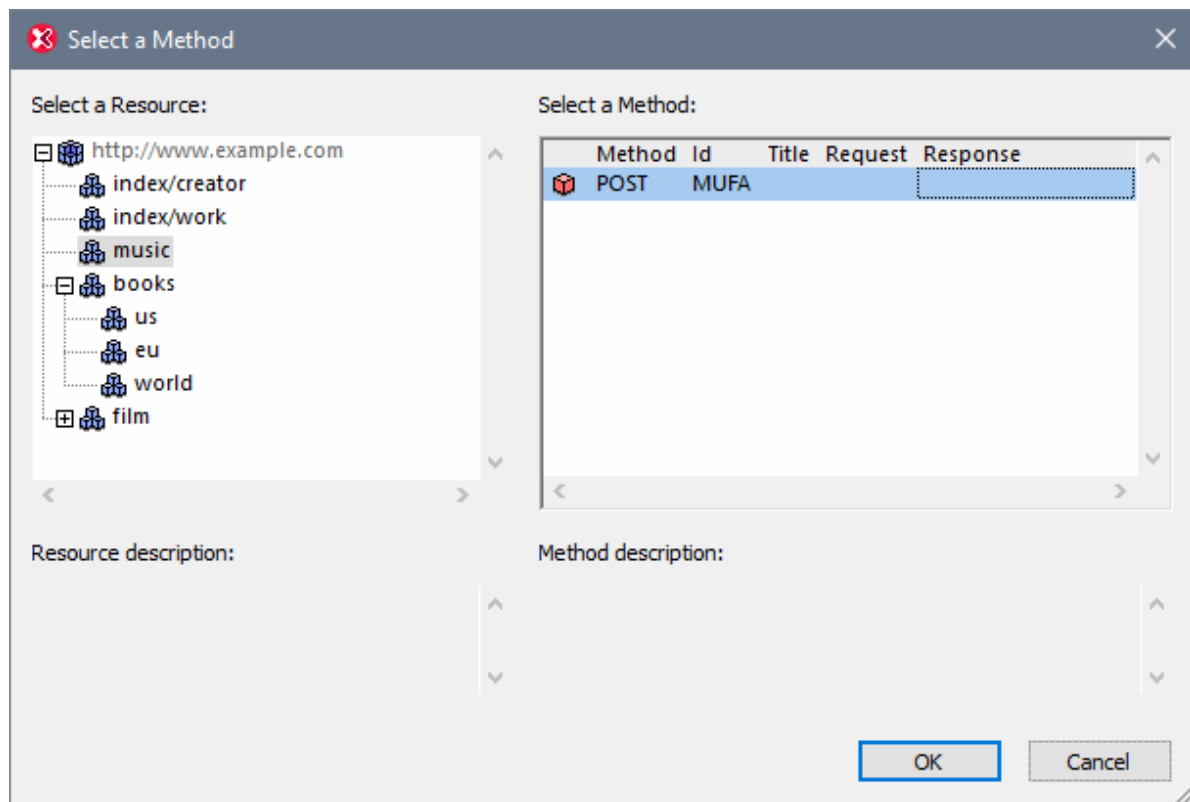

3. In the left-hand pane (see *screenshot above*), select the relevant WSDL endpoint or WADL resource (the one containing the request you want to import).
4. In the right-hand pane (see *screenshot above*), select the request (the WSDL operation or WADL method) that you want to import. Note that, for import via WSDL: (i) HTTP import is provided only for SOAP and HTTP extensibilities, and (ii) only supported bindings (SOAP and HTTP) are displayed in this (the right-hand) pane.
5. Click **OK**. If the request contains one or more parameters, then the next screen of the wizard (*screenshot below*) shows the parameters of the request you selected; otherwise, the request is imported into the [HTTP output window](#)⁵⁸³ and the wizard closes; see *point 7 below*. Parameters are parts of the request. In a search request, for example, one parameter might be the search term. The wizard validates a parameter's value against its datatype, and indicates one of three states. A pink background indicates an invalid value; a beige background indicates an incorrect value that will nevertheless be entered in the request and sent; a white background indicates a valid value.

URI Template:

Please enter parameter values:

| <input type="checkbox"/> | URI Variable | Style | Name | Type | Value | Description |
|-------------------------------------|--------------|--------|-----------|---------|------------------|-------------|
| <input checked="" type="checkbox"/> | id | matrix | id | integer | | |
| <input checked="" type="checkbox"/> | ean | matrix | ean | integer | empty | |
| <input checked="" type="checkbox"/> | inventory | matrix | inventory | short | 70000 | |
| <input checked="" type="checkbox"/> | sales | matrix | sales | short | | |
| <input checked="" type="checkbox"/> | online | matrix | online | boolean | false | |
| <input checked="" type="checkbox"/> | review | matrix | review | boolean | yes | |
| <input checked="" type="checkbox"/> | usd | matrix | usd | boolean | true | |
| <input checked="" type="checkbox"/> | | query | Query | string | @#S%^*() | |
| <input checked="" type="checkbox"/> | | header | Referer | anyURI | http://localhost | |

Output URI:

Headers:

6. In the HTTP Request Parameters screen (*screenshot above*), enter or edit parameter values as needed (in the *Values* column). Note that you might not be allowed to edit some parameter values; the cells of such values are disabled for editing. If you wish to not use a parameter, then deactivate it by unchecking its *Activate* check box (in the first column). Note that some parameters are mandatory, so the *Activate* check box will be locked and you will not be able to uncheck it. Notice that, as you edit the parameter values, the request is being built in the *Output URI* field. The parameter grid also contains one or more rows for headers (at the bottom of the grid). These headers come from the WADL file, and their values can be edited in the grid if this is allowed according to the definitions in the WADL file. A summary of the headers is listed in the *Header* field at the bottom of the window.
7. Click **OK**. The request is imported into the [HTTP output window](#)⁵⁸³, and is shown there in the following way: (i) In the method combo box, the request's HTTP method will be displayed; (ii) the URL will be constructed on the basis of the request's parameters; (ii) the HTTP headers of the request will be entered in the *Headers* tab. Note that, if the request is a `POST` or `PUT` request, the body of the request will not be entered in the *Body* tab; it will need to be added manually.
8. Check the *Settings* tab to see if you need to modify the settings.
9. Click **Send** to send the request.

15.3 Receiving the Response

The response to an HTTP request is displayed in the right-hand pane of the HTTP output window (see *screenshot below*).

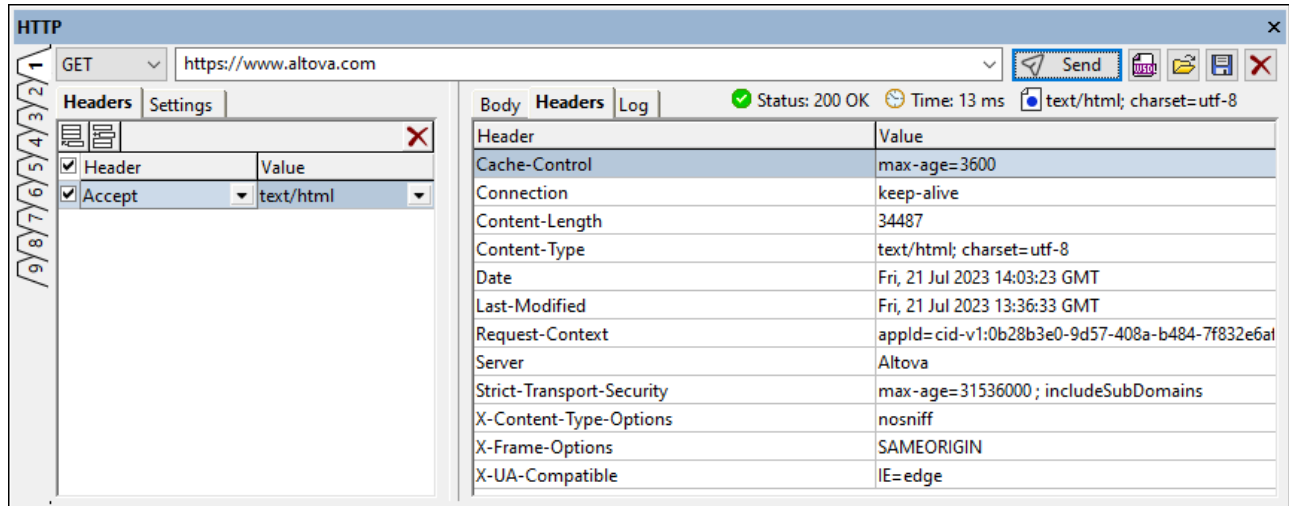

To the right of the *Body*, *Headers*, and *Log* tabs are listed the following details about the response:

- The HTTP status code ([explained below](#) ⁵⁹³)
- The time from connection made to last response-chunk received
- The **Content-Type** of the response

The Response pane has three tabs: *Body* (*screenshot below left*), *Headers* (*screenshot above*), and *Log* (*screenshot below right*).

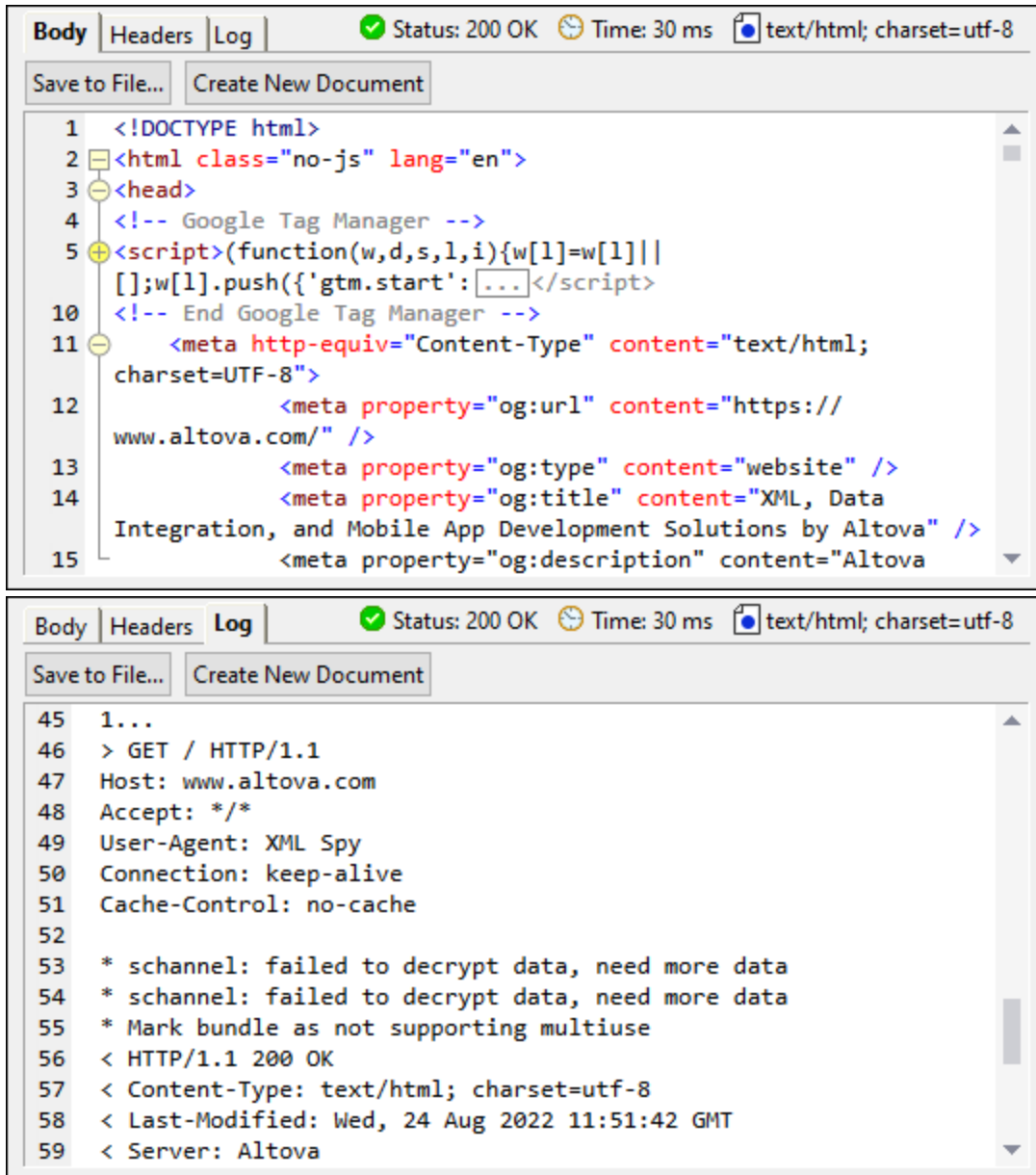

- **Body tab:** The body of the response is displayed with syntax coloring if the document is HTML, XML, or JSON, and with line-numbering. The tab has two buttons: (i) **Save to File** to save the body to a file, and (ii) **Create New Document** to create a new document in XMLSpy and display the newly created document in the Main Window of the GUI. A newly created document can be edited and saved in the usual way. If a new document cannot be created from the body of the response (for example if the body is an image), then the **Create New Document** button is disabled (see screenshot further below).
- **Headers tab:** Contains the headers of the response. The **Content-Type** header is also displayed at the top of the pane.
- **Log tab:** Events and information relating to the request are displayed in the Log tab, which has line-numbering. The log can be saved to file or created as a new document in the Main Window. A newly created document can be edited and saved in the usual way.

HTTP status codes

Status codes are categorized as follows:

- 2XX codes are used for successful requests.
- 3XX codes are used for redirects.
- 4XX codes are used if there was a problem with the request.
- 5XX codes are used if there was a problem with the server.

Some commonly encountered codes:

- *200 OK*: Sent in response to a successful request.
- *206 Partial Content*: The server sends only a part of the resource because only a range of the resource was requested.
- *301 Moved Permanently*: The request should be redirected to the given URL.
- *401 Unauthorized*: The resource requires authentication, and authentication has either failed or not been provided.
- *403 Forbidden*: Valid request, but the server is refusing action. This might be because the user does not have the necessary credentials.
- *404 Not Found*: The resource could not be found.
- *500 Internal Server Error*: A generic error message; sent when no more specific message is available.

See: [A complete list of HTTP status codes](#).

The Accept Header

The Accept header of the request specifies the content type to accept in the response. For example, see the difference between the responses when `Accept=image` (*first screenshot below*) and when `Accept=image/png` (*second screenshot below*). In the first case, since it is not specified what image format should be sent in the response, an error status code and a JSON message containing more information is sent.

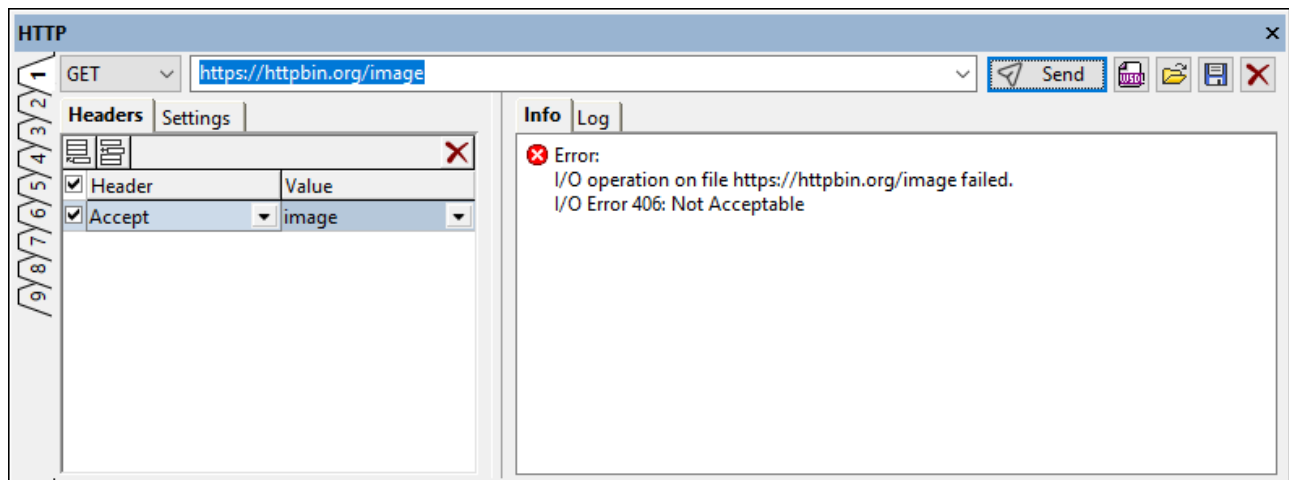

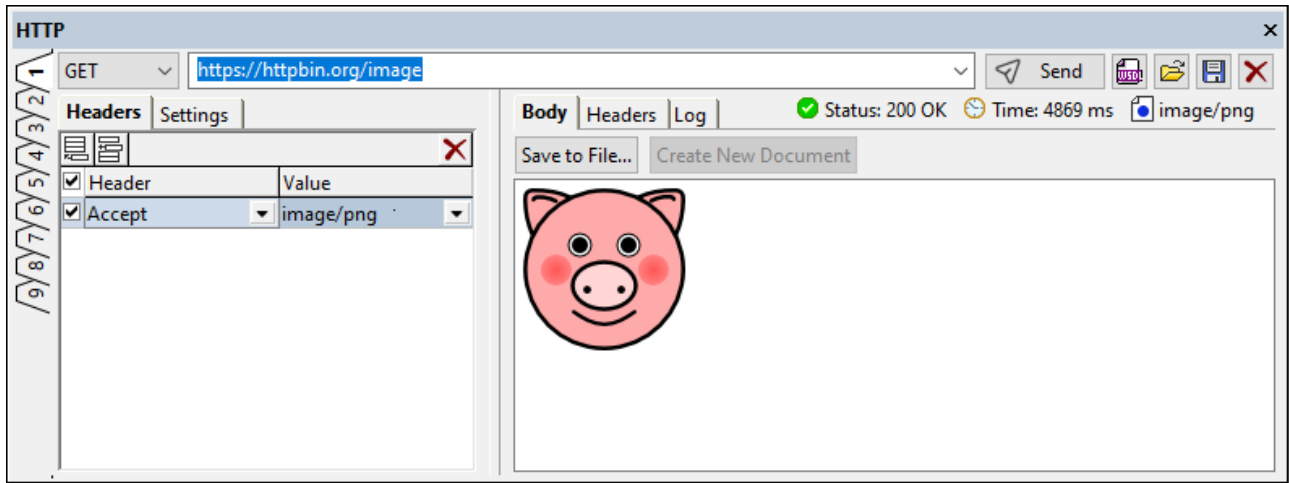

16 Office Open XML, ZIP, EPUB

Office Open XML (OOXML), ZIP files, and EPUB files are similar in that all are packages containing other files. XMLSpy's Archive View provides an interface that enables you to view the internal structure of these packages, modify these structures, and access the files in the package for editing in XMLSpy. In the case of EPUB files, Archive View also enables you to directly view the EPUB book in the Browser View of XMLSpy.

Office Open XML (OOXML)

OOXML is a file format for describing documents, spreadsheets, and presentations. It was originally developed by Microsoft for the company's Office suite of products but is now an open ECMA specification.

Structure of an OOXML file

Each OOXML document is a package of multiple files that follows the Open Packaging Convention. A package consists of XML and other data files (such as image files) plus a relationships file that specifies the relationships among the various files in the package.

The internal structure and internal folder and file names of an OOXML file vary according to the document type. However, there is a common basic structure: an XML file called `[Content_Types].xml` at the root of the directory structure, and three directories: `_rels`, `docProps`, and a directory specific to the document type (in the case of `.docx` documents, for example, this folder would be called `word`; `xl` in `.xlsx` documents, and `ppt` in `.pptx` documents).

```
OOXML File
|-- File:      [Content_Types].xml
|-- Folder:   _rels
|-- Folder:   docProps
|-- Folder:   word/xl/ppt
```

- The `_rels` folder contains a `rels.xml` file, which specifies the relationships between the various files in the package.
- The `docProps` folder contains `app.xml` and `core.xml`, which describe key document properties.
- The `word`, `xl`, and `ppt` folders contain XML files that hold the content of the document. For example, in the `word` folder, the file `document.xml` contains the core content of the document.

OOXML in XMLSpy's Archive View

In XMLSpy's Archive View (*screenshot below*), you can view and edit the contents of an OOXML file.

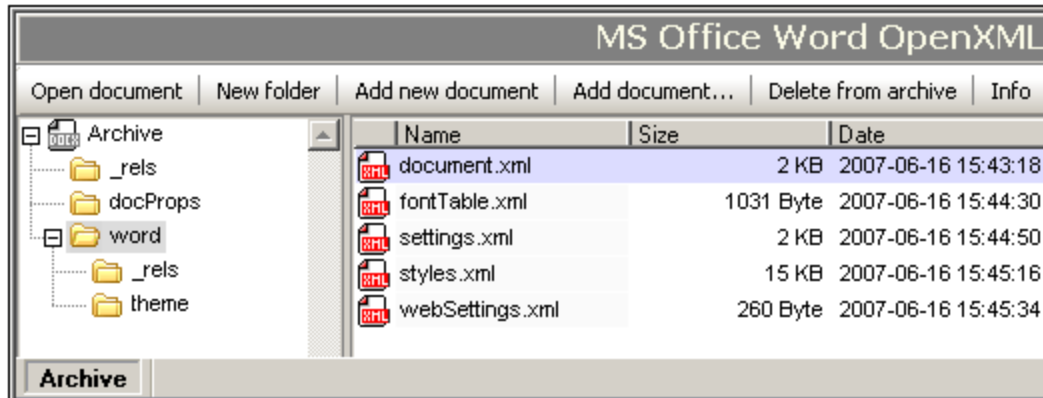

Folder View on the left-hand side shows the folders in the package, whereas the Main Window shows the files in the folder selected in Folder View. In Archive View, files and folders can be added to and deleted from the archive. Also, files can be opened quickly for editing in XMLSpy by double-clicking the file in Archive View.

Intelligent editing of OOXML's internal files

The XML documents within OOXML packages are based on standard schemas. XMLSpy provides intelligent editing support for OOXML documents, in the form of entry helpers, auto-completion, and validation.

ZIP files

ZIP files archive multiple files in a lossless data compression package. These files can be of various types. In XMLSpy's Archive View, ZIP files can be created, the internal structure modified, and files in the archive edited. These operations are described in the [ZIP Files](#)⁶⁰¹ sub-section of this section.

EPUB files

An EPUB file is a zipped group of files used for the distribution of digital publications (EPUB books). In [Archive View](#)²⁷⁸, you can open EPUB files, create and edit EPUB files, preview the digital EPUB book, edit component files of the EPUB archive directly in XMLSpy, validate the EPUB file, and save the component files back to the EPUB archive. See the section, [EPUB Files](#)⁶⁰³, for details.

16.1 Working with OOXML Files

This section describes how to work with OOXML documents in Archive View. The following procedures are discussed:

- [Creating, opening, and saving OOXML files](#) ⁵⁹⁷
- [Editing the structure of an OOXML file](#) ⁵⁹⁷
- [Opening, editing, and saving internal OOXML documents](#) ⁵⁹⁸
- [Intelligent editing of internal OOXML documents](#) ⁵⁹⁸
- [Addressing documents in OOXML files](#) ⁵⁹⁸
- [Comparing OOXML archives](#) ⁵⁹⁷

Creating, opening, and saving OOXML files

OOXML files are created via the Create New Document dialog (**File | New** command), in which you select the required file type (.docx, .pptx, or .xlsx). You are prompted for a file name and a location at which to save the file. The new file is created at the specified location and then opened in Archive View (*screenshot below*). Notice that the basic internal structure of the OOXML document has been created.

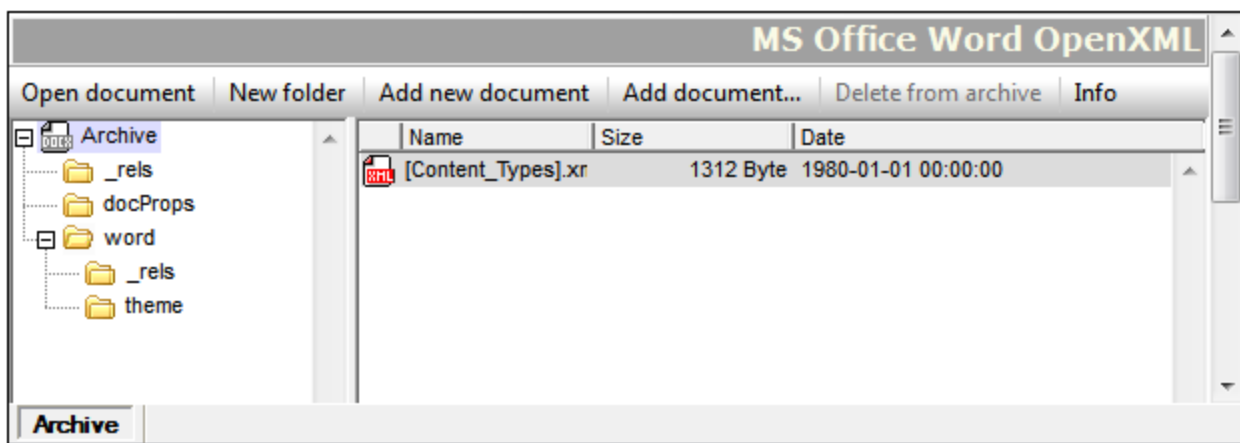

An existing OOXML file is opened in Archive View via the Open dialog (**File | Open**) of XMLSpy. OOXML files are saved with the **File | Save (Ctrl+S)** command. This command saves the structure and relationships of the OOXML file.

Editing the structure of an OOXML file

The contents of an OOXML file can be modified by adding and deleting folders and documents to it using [Archive View](#) ²⁷⁸ functionality. After these structural changes have been made, the OOXML file must be saved (**File | Save**) for the modifications to take effect. You should note the following points:

- When a new folder or document is added using the [command buttons in Archive View](#) ²⁷⁸, it should be named immediately on its being created. It is not possible to rename a folder or document in Archive View.
- After a new document has been added to an archive folder, it is saved to the archive by saving it in its own window or by saving the OOXML file.

Opening, editing, saving internal OOXML documents

An internal OOXML document—that is, a document within an OOXML file package—is opened from Archive View by double-clicking it, or by selecting it in the Main Window and clicking the [Open document](#)²⁷⁸ command button. The document opens in a separate XMLSpy window. After editing it, simply save the document to save it back to the OOXML archive; there is no need to save the OOXML file itself.

Intelligent editing of internal OOXML documents

XMLSpy provides intelligent editing features for internal Office Open XML documents—that is, for documents within an OOXML file package. These features include entry helpers, auto-completion, and validation.

Addressing documents in OOXML files

Documents in OOXML files can be addressed using normal file paths plus the pipe character. For example, the file path:

```
C:\Documents and Settings\\My
Documents\Altova\XMLSpy2024\Examples\Office20XX\ExcelDemo.xlsx|zip\xl\tables\table1.xml
```

locates the file `table1.xml`, which is in the `xl\tables` folder of the OOXML file `ExcelDemo.xlsx` located in the `Examples\Office20XX` folder of the XMLSpy examples folder.

Comparing OOXML archives

When an OOXML file is open in Archive View, you can compare it with another archive by using the command [Tools | Compare Directories](#)¹⁰¹².

16.2 OOXML Example Files

In the `Examples\Office` folder of your XMLSpy application folder are the following example files:

- OOXML files: (i) a Word Open XML file (`.docx`), (ii) an Excel Open XML file (`.xlsx`), and (iii) a PowerPoint Open XML file (`.pptx`)
- XSLT files: (i) `docx2html.xslt` (to convert the sample `.docx` file to HTML), (ii) `xlsx2html.xslt` (to convert the sample `.xlsx` file to HTML), and (iii) `pptx2html.xslt` (to convert the sample `.pptx` file to HTML)
- An XQuery file: `ExcelDemo.xq` (to retrieve data from the `.xlsx` file)

The XSLT and XQuery files are intended to demonstrate how XSLT and XQ can be used to access and transform data in OOXML files. To run the XSLT and XQuery documents, you can use any of the following options:

- Open the OOXML file in Archive View. In Folder View, select `Archive` and then click the menu command **XSL/XQuery | XSL Transformation** (for an XSLT transformation) or **XSL/XQuery | XQuery Execution** (for an XQuery execution). Browse for the XSLT or XQuery file and click **OK**.
- In the Project Window of XMLSpy, right-click the `.xlsx`, `.pptx` or `.docx` file in the `Office` folder of the `Examples` project (*screenshot below*), and select the transformation command. Browse for the transformation file and click **OK**.

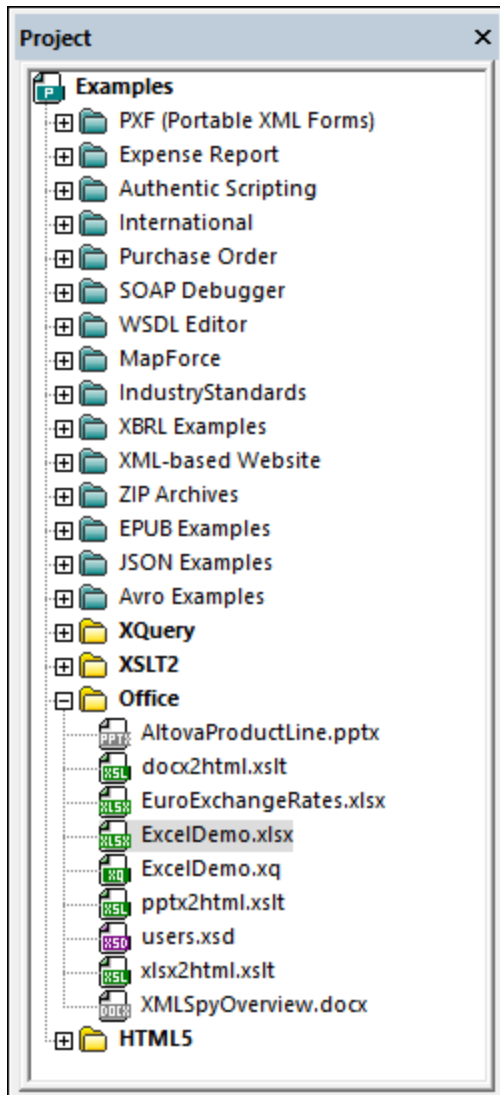

- Open the XSLT or XQuery file in XMLSpy and click the menu command **XSL/XQuery | XSL Transformation** and **XSL/XQuery | XQuery Execution**, respectively. When prompted for the XML file to transform, browse for the .docx, .xlsx, or .pptx file (according to whether the XSLT/XQ document is intended for MS Word, MS Excel, or MS PowerPoint).

16.3 ZIP Files

In [Archive View](#)²⁷⁸, you can create WinZip files, modify the internal structure of ZIP files (WinZip, WinRAR, etc), and edit files in the ZIP package directly in XMLSpy and save the files back to the ZIP archive.

Creating and saving a WinZip file

A WinZip file is created via the Create New Document dialog (**File | New** command), in which you select the file type `.zip`. An empty WinZip archive is created in a new window in XMLSpy (*screenshot below*). You must now save the ZIP file to the desired location with the **File | Save (Ctrl+S)** command. Add folders and files as described below, and then save the ZIP file to save your additions and changes.

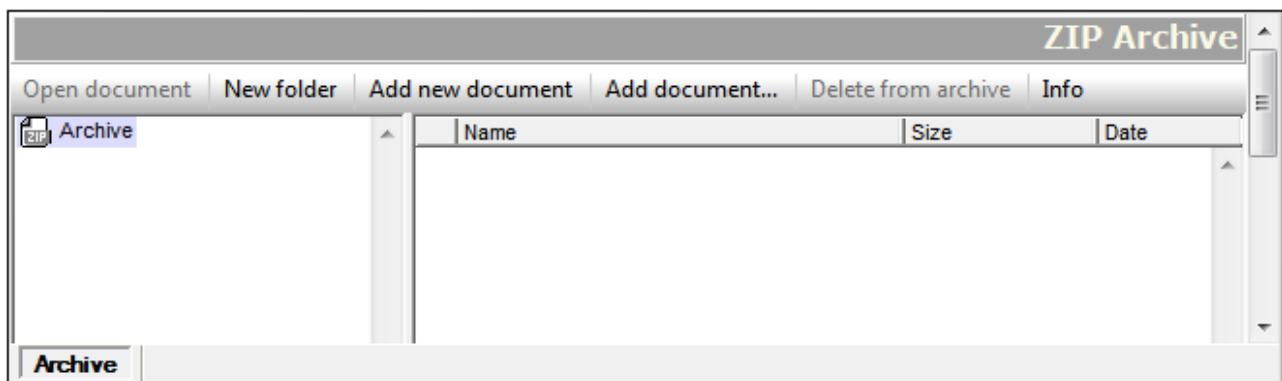

An existing ZIP file is opened in Archive View via the Open dialog (**File | Open**) of XMLSpy.

Note: Creating a new ZIP file is different than creating a new OOXML file in that you are not prompted for a location to save the file before the archive is opened in Archive View. For the ZIP file to be saved from the empty archive that is opened in Archive View, you must explicitly use the **File | Save (Ctrl+S)** command.

Adding folders and files and modifying the archive structure

You can add folders (click the **New Folder** button), existing files (**Add Document**), and new files (**Add New Document**) to the selected Archive folder. Note that when you add a new folder or new document, you must immediately enter a name for the folder or file; it is not possible to rename folders or documents in Archive View.

Addressing documents in ZIP files

Documents in ZIP files can be addressed using normal file paths plus the pipe character. For example, the file path:

```
C:\Documents and Settings\\My Documents\Altova\XMLSpy2024\Examples\Test.zip|zip\TestFolder\MyFile.xml
```

locates the file `MyFile.xml`, which is in the `TestFolder` folder of the ZIP file `Test.zip` located in the `Examples` folder of the XMLSpy examples folder.

Comparing ZIP archives

When a ZIP file is open in Archive View, you can compare it with another archive by using the command [Tools | Compare Directories](#)¹⁰¹².

16.4 EPUB Files

An EPUB file is a zipped group of files conforming to the [EPUB standard](#) of the [International Digital Publishing Forum \(IDPF\)](#). This standard is the distribution and interchange standard for digital web publications. In [Archive View](#)²⁷⁸, you can open EPUB files, view the EPUB file's digital publication in a preview tab, edit component files of the EPUB archive directly in XMLSpy, validate the EPUB file, and save the component files back to the EPUB archive.

Note: (i) XMLSpy supports [EPUB 2.0.1](#). (ii) A sample EPUB file is available in the `Examples` project and in the `(My) Documents/Altova/XMLSpy2024/Examples` folder.

Terminology

In the descriptions below, terms are used as follows:

- **EPUB file** is used to indicate the EPUB file having the file extension `.epub`. This is the ZIP file that contains the whole archive and is the file that will be opened in Archive View
- An **archive file** is any one of the files contained in the EPUB archive
- **EPUB book** is the term used to indicate the digital publication generated by the zipped EPUB file

In this section

The description below of EPUB functionality in XMLSpy is structured into the following parts:

- [Opening EPUB files in Archive View](#)⁶⁰³
- [Creating a new EPUB file](#)⁶⁰⁴
- [Previewing an EPUB book](#)⁶⁰⁵
- [Modifying the contents and structure of an EPUB archive](#)⁶⁰⁵
- [Info and Settings](#)⁶⁰⁵
- [Editing archive files directly in XMLSpy](#)⁶⁰⁶
- [Entry helpers for archive files](#)⁶⁰⁶
- [Validating EPUB file](#)⁶⁰⁶

Opening EPUB files in Archive View

Select the menu command **File | Open**, navigate to the EPUB file, and click **Open**. The EPUB file opens in Archive View (*screenshot below*). Alternatively, you can right-click the EPUB file in Windows Explorer and select the context menu command to open the file with XMLSpy. If you have [set XMLSpy to be the default editor of EPUB files](#)¹⁰⁴³, then double-clicking the EPUB file will open the file in Archive View.

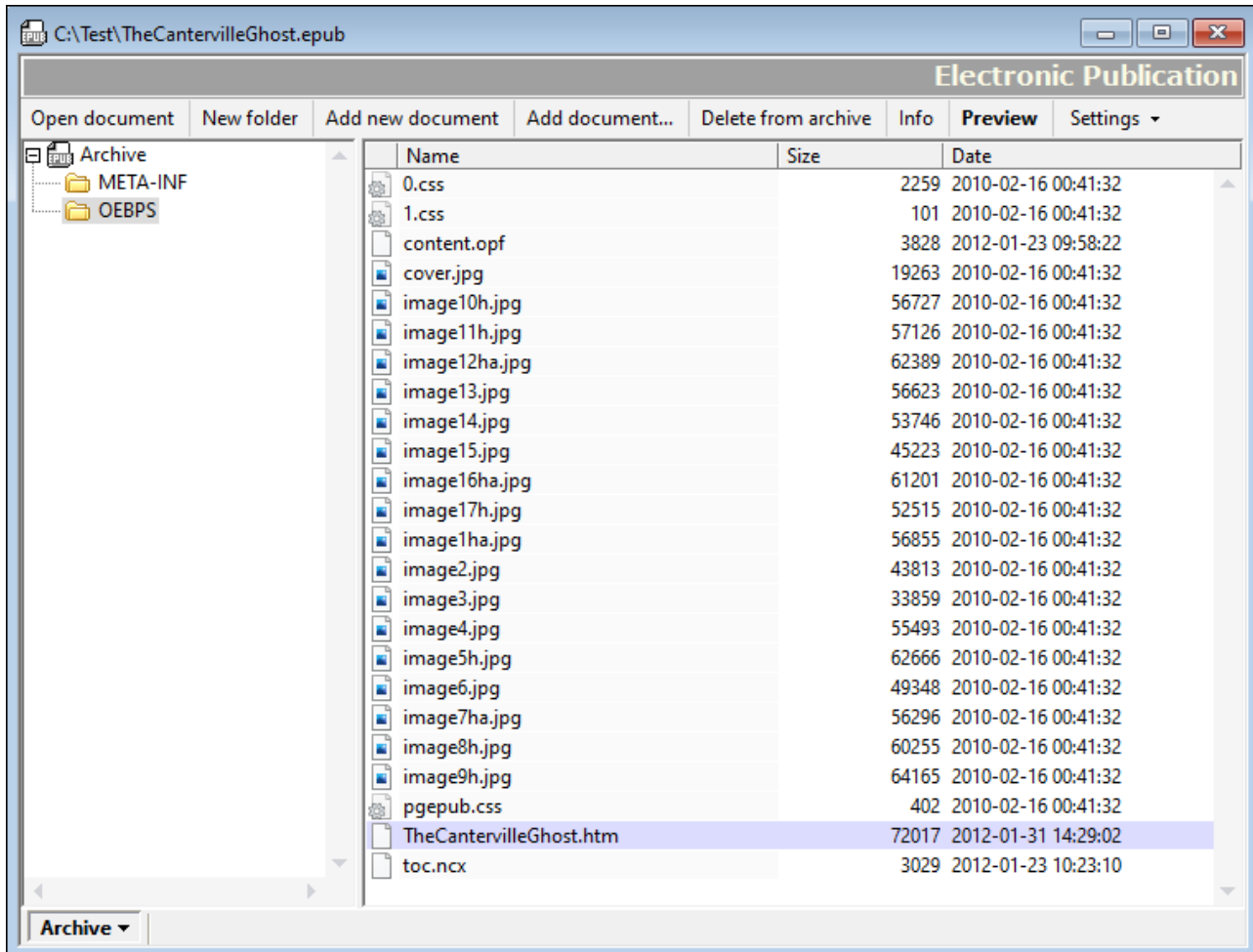

Folder View on the left-hand side shows the folders in the archive, whereas the Main Window shows the files in the folder selected in Folder View. The EPUB archive will have the following structure and the following key components.

```

Archive
|-- Mimetype file
|
|-- META-INF folder
|   |-- container.xml
|
|-- DOCUMENT folder (In the screenshot above, OEBPS is the Document folder.)
    |-- Contains HTML, CSS, image files, plus OPF and NCX files

```

Creating a new EPUB file

To create a new EPUB file, select the menu command **File | New**. In the Create New Document dialog that pops up, select the file type `.epub`. In the Save As dialog that now pops up, give a name for your EPUB document and click **Save**. A skeleton EPUB archive containing all the folders and files of a valid EPUB archive (see *archive structure above*) will be created in a new window in Archive View. Add the folders and files you

wish to add to the archive, as described below, and then save the EPUB file. To edit an archive file directly in XMLSpy, double-click the file in Archive View. The file will open in a new XMLSpy window. Edit it and then save it with the **File | Save (Ctrl+S)** command.

Previewing an EPUB book

To preview an EPUB book, make the EPUB file active in Archive View, then click the **Preview** button in the toolbar of Archive View. The EPUB book will open in a separate (Internet Explorer) browser window in XMLSpy. If any of the files that will be used for the preview—whether a content file or a structure-related file—has been modified but not yet saved, you will be prompted to save the file. If you do not save the modifications, the preview will use the previously saved data and might not be up-to-date. You can specify that all modified files be saved automatically before previewing by toggling on this setting (via the **Settings** button in the the toolbar of Archive View).

Note the following:

- If the **Preview** button in Archive View is clicked while a Preview window of that EPUB publication is still open, then the EPUB publication will be reloaded in the open Preview window.
- Refreshing the Preview window itself (using the **Refresh (F5)** command of Internet Explorer) will not update the Preview window. The EPUB publication in the Preview window must be updated using the **Preview** button (of Archive View) of the corresponding EPUB file (*see previous point*).
- To close the preview, close the Preview window.

Note: Not all EPUB markup is supported in Internet Explorer, so previews could be distorted. Additionally, if the digital publication document is XML—and not HTML—the preview might not work. Newer versions of Internet Explorer provide improved handling of EPUB markup, so if you experience problems, try updating to the latest version of Internet Explorer.

Modifying the contents and structure of an EPUB archive

You can add folders (click the **New Folder** button), new files (**Add New Document**), and existing files (**Add Document**) to the selected archive folder. Note that when you add a new folder or new document, you must immediately enter a name for the folder or file; it is not possible to rename folders in Archive View. You can delete a file or folder by selecting it and clicking the **Delete from Archive** button.

After you have modified the archive you must save the EPUB file (**File | Save**) for the changes to be saved.

Info and Settings

Clicking the **Info** button displays, at the bottom of Archive View, a summary of key archive information (*screenshot below*). Clicking the **Info** button again removes the summary. The summary reports the number of files in the archive (including the Mime type file and `container.xml`), the size of the compressed EPUB file, and the cumulative size of the unzipped files.

| General | |
|-----------------|---------|
| Files: | 26 |
| Compressed: | 943 KB |
| Uncompressed: | 1005 KB |
| Compress ratio: | 93% |

The **Settings** button contains drops down two automatic file-saving options that can be toggled on and off: to automatically save the EPUB file (i) before validation, and (ii) before previewing the EPUB file in (via the **Preview** button) in XMLSpy.

Editing archive files directly in XMLSpy

To edit an archive file directly in XMLSpy, double-click the file in Archive View. Alternatively, select the file in Archive View and click the Open Document button in the toolbar of Archive View. The file will open in a new XMLSpy window. Edit it and then save it with the **File | Save (Ctrl+S)** command.

Entry helpers for archive files

Entry helpers for standards-based archive files are available when these archive files are opened in XMLSpy. These archive files are:

- The OPF file, traditionally named `content.opf`, contains the EPUB book's metadata. It is based on the [Open Packaging Format \(OPF\) specification](#).
- The NCX file (Navigation Control file for XML), traditionally named `toc.ncx`, contains the publication's table of contents. It is based on the [NCX part](#) of the OPF specification.
- The folder named `META-INF` must contain the file `container.xml`, which points to the file defining the contents of the book (the OPF file). The file `container.xml` specifies how the archive files should be organized according to rules in the [Open Container Format \(OCF\) specification](#).

Validating an EPUB file

To validate an EPUB file, select the command **XML | Validate XML (F8)**. The validation results are displayed in the Messages window (*screenshot below*). If any of the archive files—whether a content file or a structure-related file—has been modified but not yet saved, you will be prompted to save the file. You must save the modified files in order to validate the EPUB file. You can specify that all modified files be saved automatically before validation by toggling on this setting (via the **Settings** button in the the toolbar of Archive View).

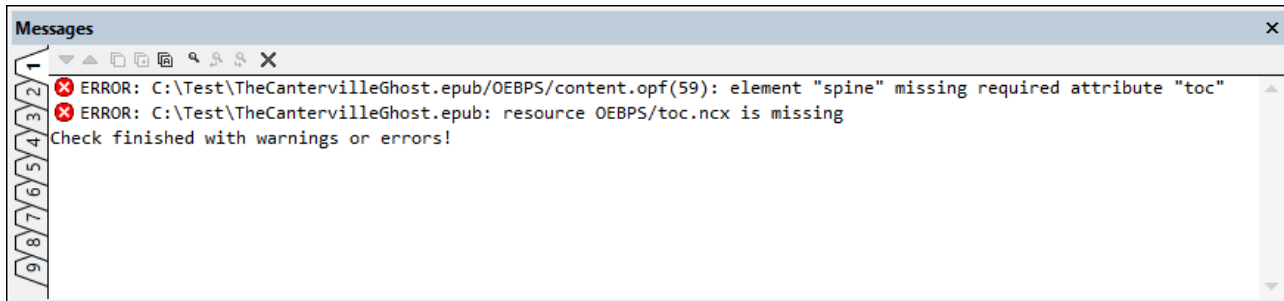

Error messages display: (i) the file in which the error was found, and, if applicable, the number of the line in which the error occurs; (ii) a description of the error. In the screenshot above, the highlighted error occurs in line 21 of the file `content.opf`. Clicking on the error line in the Messages window opens the relevant file and highlights the error.

Note: The EPUB validation engine is a Java utility, so Java must be installed on your machine for the validation engine to run.

17 Databases

XMLSpy enables you to connect to a variety of databases (DBs) and then perform operations such as querying the DB, importing the DB structure as an XML Schema, generating an XML data file from the DB, and exporting data to a DB. Each DB-related feature is available in XMLSpy as a menu command, and is described in the [User Reference](#)⁷⁸¹ section of this documentation under the respective command. A complete list of these commands is given below, with links to the respective descriptions.

In this section, we do the following:

- Describe [how to connect to a database](#)⁶⁰⁹, which is an operation that is required for executing any of XMLSpy's DB-related commands; and
- [List DBs](#)⁶⁹⁵ that have been successfully tested for use with XMLSpy.

Note: If you are using the 64-bit version of XMLSpy, ensure that you have access to the 64-bit database drivers needed for the specific database you are connecting to.

XMLSpy's DB-related features

XMLSpy's DB-related features are executed with commands in the [DB](#)⁹³² and [Convert](#)⁹⁶¹ menus.

- [Query Database](#)⁹³²: In the **DB** menu. Loads the structure of the DB in a separate Database Query window and enables queries to the DB. Results are displayed in the Database Query window.
- [IBM DB2](#)⁹⁴⁸: In the **DB** menu. IBM DB2 is an XML DB, and XMLSpy enables management of the XML Schemas of the XML DB as well as editing and validation of the XML DB.
- [SQL Server](#)⁹⁵³: In the **DB** menu. XMLSpy enables management of the XML Schemas of the DB as well as editing and validation features.
- [Oracle XML DB](#)⁹⁵⁶: In the **DB** menu. Provides a range of functionality for Oracle XML DBs, including XML Schema management, database querying, and generation of XML files based on DB schemas.
- [Import Database Data](#)⁹⁶⁴: In the **Convert** menu. Imports DB data into an XML file.
- [Create XML Schema from DB Structure](#)⁹⁶⁸: In the **Convert** menu. Generates an XML Schema that is based on the structure of the DB.
- [DB Import Based on XML Schema](#)⁹⁷⁴: In the **Convert** menu. With an XML Schema document active in XMLSpy, a DB connection is made and the data of a selected DB table can be imported. The resulting XML document will have a structure based on the XML Schema that was active when the DB connection was made.
- [Create DB Structure from XML Schema](#)⁹⁷⁵: In the **Convert** menu. DB tables with no data are created based on the structure of an existing XML Schema.
- [Export to Database](#)⁹⁸¹: In the **Convert** menu. Data from an XML document can be exported to a DB. Existing DB tables can be updated with the XML data, or new tables can be created that contain the XML data.

Datatype conversions

When converting data between XML documents and DBs, datatypes must necessarily be converted to types appropriate for the respective formats. The way XMLSpy converts datatypes is given in the appendices [Datatypes in DB-Generated XML Schemas](#)¹⁶⁴⁷ and [Datatypes in DBs Generated from XML Schemas](#)¹⁶⁵³.

Altova DatabaseSpy

Altova's DatabaseSpy is a multi-database query and DB design tool that offers additional DB functionality to that available in XMLSpy. For more details about Altova DatabaseSpy, visit the [Altova website](#).

17.1 Connecting to a Data Source

In the most simple case, a database can be a local file such as a Microsoft Access or SQLite database file. In a more advanced scenario, a database may reside on a remote or network database server which does not necessarily use the same operating system as the application that connects to it and consumes data. For example, while XMLSpy runs on a Windows operating system, the database from which you want to access data (for example, MySQL) might run on a Linux machine.

To interact with various database types, both remote and local, XMLSpy relies on the data connection interfaces and database drivers that are already available on your operating system or released periodically by the major database vendors. In the constantly evolving landscape of database technologies, this approach caters for better cross-platform flexibility and interoperability.

The following diagram illustrates, in a simplified way, data connectivity options available between XMLSpy (illustrated as a generic client application) and a data store (which may be a database server or database file).

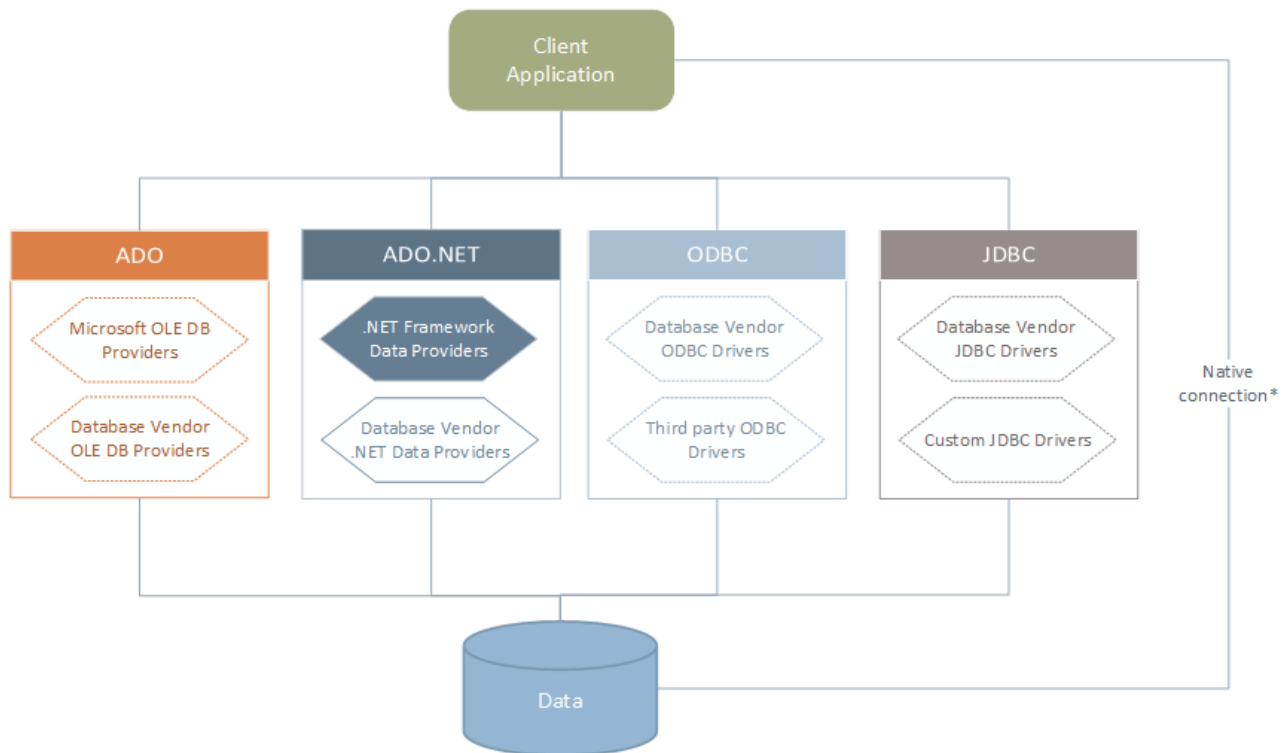

* Direct native connections are supported for SQLite, MySQL, MariaDB, PostgreSQL databases. To connect to such databases, no additional drivers are required to be installed on your system.

As shown in the diagram above, XMLSpy can access any of the major database types through the following data access technologies:

- ADO (Microsoft® ActiveX® Data Objects), which, in its turn, uses an underlying OLE DB (Object Linking and Embedding, Database) provider
- ADO.NET (A set of libraries available in the Microsoft .NET Framework that enable interaction with data)

- JDBC (Java Database Connectivity)
- ODBC (Open Database Connectivity)

Note: Some ADO.NET providers are not supported or have limited support. See [ADO.NET Support Notes](#)⁶²⁷.

About data access technologies

The data connection interface you should choose largely depends on your existing software infrastructure. You will typically choose the data access technology and the database driver which integrates tighter with the database system to which you want to connect. For example, to connect to a Microsoft Access 2013 database, you would build an ADO connection string that uses a native provider such as the **Microsoft Office Access Database Engine OLE DB Provider**. To connect to Oracle, on the other hand, you may want to download and install the latest JDBC, ODBC, or ADO.NET interfaces from the Oracle website.

While drivers for Windows products (such as Microsoft Access or SQL Server) may already be available on your Windows operating system, they may not be available for other database types. Major database vendors routinely release publicly available database client software and drivers which provide cross-platform access to the respective database through any combination of ADO, ADO.NET, ODBC, or JDBC. In addition to this, several third party drivers may be available for any of the above technologies. In most cases, there is more than one way to connect to the required database from your operating system, and, consequently, from XMLSpy. The available features, performance parameters, and the known issues will typically vary based on the data access technology or drivers used.

17.1.1 Start Database Connection Wizard

XMLSpy provides a Database Connection Wizard that guides you through the steps required to set up a connection to a data source. Before you go through the wizard steps, be aware that for some database types it is necessary to install and separately configure several database prerequisites, such as a database driver or database client software. These are normally provided by the respective database vendors, and include documentation tailored to your specific Windows version. For a list of database drivers grouped by database type, see [Database Drivers Overview](#)⁶¹².

To start the Database Connection Wizard (see *screenshot below*), do the following:

- On the **DB** menu, click **Query Database**.

The Database Connection Wizard (*screenshot below*) is started. On the left hand side of the window, you can select the most suitable from the following ways to connect to your database:

- Connection Wizard, which prompts you to choose your database type and then guides you through the steps for connecting to a database of that type
- Select an existing connection
- Select a data access technology: ADO, ADO.NET, ODBC, or JDBC
- Use an Altova global resource in which database connection is stored
- A native PostgreSQL connection

In the Connection Wizard pane (see *screenshot below*) databases can be sorted alphabetically by the name of the database type or by recent usage. Select the option you want in the *Sort By* combo box. After you have selected the database type to which you want to connect, click **Next**.

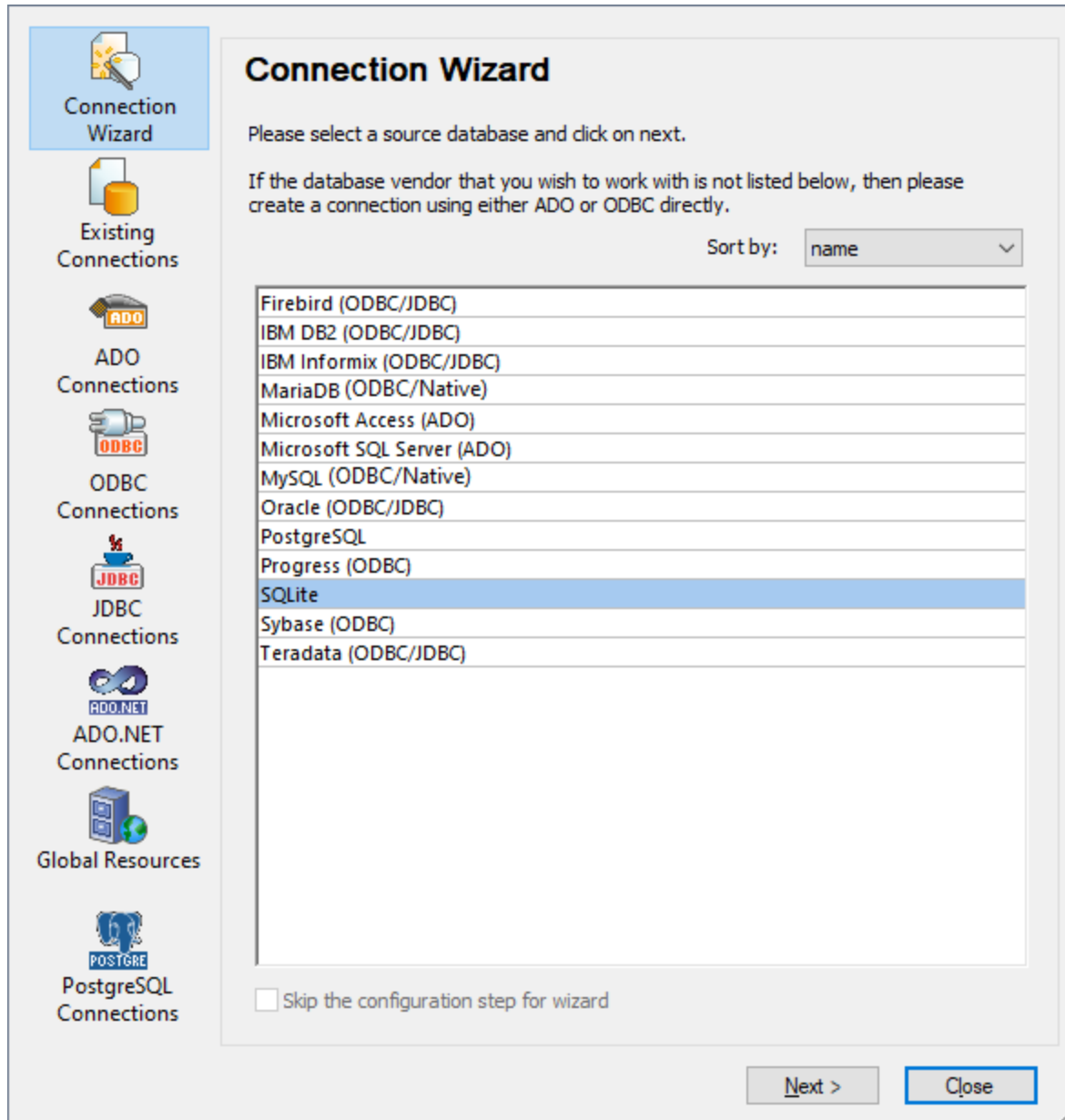

The wizard will take you through the next steps according to the database type, connection technology (ADO, ADO.NET, ODBC, JDBC), and driver that will be used. For examples applicable to each database type, see [Database Connection Examples](#) ⁶⁴⁰.

Alternatively to using Connection Wizard, you can use one of the following database access technologies:

- [Setting up an ADO Connection](#) ⁶¹⁵
- [Setting up an ADO.NET Connection](#) ⁶²¹
- [Setting up an ODBC Connection](#) ⁶²⁸
- [Setting up a JDBC Connection](#) ⁶³¹

17.1.2 Database Drivers Overview

The following table lists common database drivers you can use to connect to a particular database through a particular data access technology. Note that this list does not aim to be either exhaustive or prescriptive; you can use other native or third party alternatives in addition to the drivers shown below.

Even though a number of database drivers might be already available on your Windows operating system, you may still need to download an alternative driver. For some databases, the latest driver supplied by the database vendor is likely to perform better than the driver that shipped with the operating system.

Database vendors may provide drivers either as separate downloadable packages, or bundled with database client software. In the latter case, the database client software normally includes any required database drivers, or provides you with an option during installation to select the drivers and components you wish to install. Database client software typically consists of administration and configuration utilities used to simplify database administration and connectivity, as well as documentation on how to install and configure the database client and any of its components.

Configuring the database client correctly is crucial for establishing a successful connection to the database. Before installing and using the database client software, it is strongly recommended to read carefully the installation and configuration instructions of the database client; these may vary for each database version and for each Windows version.

To understand the capabilities and limitations of each data access technology with respect to each database type, refer to the documentation of that particular database product and also test the connection against your specific environment. To avoid common connectivity issues, note the following:

- Some ADO.NET providers are not supported or have limited support. See [ADO.NET Support Notes](#) ⁶²⁷.
- When installing a database driver, it is recommended that it has the same platform as the Altova application (32-bit or 64-bit). For example, if you are using a 32-bit Altova application on a 64-bit operating system, install the 32-bit driver, and set up your database connection using the 32-bit driver, see also [Viewing the Available ODBC Drivers](#) ⁶³⁰.
- When setting up an ODBC data source, it is recommended to create the data source name (DSN) as System DSN instead of User DSN. For more information, see [Setting up an ODBC Connection](#) ⁶²⁸.
- When setting up a JDBC data source, ensure that JRE (Java Runtime Environment) or Java Development Kit (JDK) is installed and that the CLASSPATH environment variable of the operating system is configured. For more information, see [Setting up a JDBC Connection](#) ⁶³¹.
- For the installation instructions and support details of any drivers or database client software that you install from a database vendor, check the documentation provided with the installation package.

| Database | Interface | Drivers |
|----------|-----------|--|
| Firebird | ADO.NET | Firebird ADO.NET Data Provider (https://www.firebirdsql.org/en/additional-downloads/) |
| | JDBC | Firebird JDBC driver (https://www.firebirdsql.org/en/jdbc-driver/) |
| | ODBC | Firebird ODBC driver (https://www.firebirdsql.org/en/odbc-driver/) |
| IBM DB2 | ADO | IBM OLE DB Provider for DB2 |
| | ADO.NET | IBM Data Server Provider for .NET |

| Database | Interface | Drivers |
|----------------------|-------------------|--|
| | JDBC | IBM Data Server Driver for JDBC and SQLJ |
| | ODBC | IBM DB2 ODBC Driver |
| IBM DB2 for i | ADO | <ul style="list-style-type: none"> • IBM DB2 for i5/OS IBMDA400 OLE DB Provider • IBM DB2 for i5/OS IBMDARLA OLE DB Provider • IBM DB2 for i5/OS IBMDASQL OLE DB Provider |
| | ADO.NET | .NET Framework Data Provider for IBM i |
| | JDBC | IBM Toolbox for Java JDBC Driver |
| | ODBC | iSeries Access ODBC Driver |
| IBM Informix | ADO | IBM Informix OLE DB Provider |
| | JDBC | IBM Informix JDBC Driver |
| | ODBC | IBM Informix ODBC Driver |
| Microsoft Access | ADO | <ul style="list-style-type: none"> • Microsoft Jet OLE DB Provider • Microsoft Access Database Engine OLE DB Provider |
| | ADO.NET | .NET Framework Data Provider for OLE DB |
| | ODBC | <ul style="list-style-type: none"> • Microsoft Access Driver |
| MariaDB | ADO.NET | In the absence of a dedicated .NET connector for MariaDB, use Connector/.NET for MySQL (https://dev.mysql.com/downloads/connector/net/). |
| | JDBC | MariaDB Connector/J (https://downloads.mariadb.org/) |
| | ODBC | MariaDB Connector/ODBC (https://downloads.mariadb.org/) |
| | Native connection | Available. No drivers are required. |
| Microsoft SQL Server | ADO | <ul style="list-style-type: none"> • Microsoft OLE DB Driver for SQL Server (MSOLEDBSQL) • Microsoft OLE DB Provider for SQL Server (SQLOLEDB) • SQL Server Native Client (SQLNCLI) |
| | ADO.NET | <ul style="list-style-type: none"> • .NET Framework Data Provider for SQL Server • .NET Framework Data Provider for OLE DB |
| | JDBC | <ul style="list-style-type: none"> • Microsoft JDBC Driver for SQL Server (https://docs.microsoft.com/en-us/sql/connect/jdbc/microsoft-jdbc-driver-for-sql-server) |
| | ODBC | <ul style="list-style-type: none"> • ODBC Driver for Microsoft SQL Server (https://docs.microsoft.com/en-us/SQL/connect/odbc/download-odbc-driver-for-sql-server) |
| MySQL | ADO.NET | <ul style="list-style-type: none"> • Connector/.NET (https://dev.mysql.com/downloads/connector/net/) |
| | JDBC | Connector/J (https://dev.mysql.com/downloads/connector/j/) |

| Database | Interface | Drivers |
|-------------------|-------------------|--|
| | ODBC | Connector/ODBC (https://dev.mysql.com/downloads/connector/odbc/) |
| | Native connection | Available for MySQL 5.7 and later. No drivers are required. |
| Oracle | ADO | <ul style="list-style-type: none"> • Oracle Provider for OLE DB • Microsoft OLE DB Provider for Oracle |
| | ADO.NET | Oracle Data Provider for .NET
(http://www.oracle.com/technetwork/topics/dotnet/index-085163.html) |
| | JDBC | <ul style="list-style-type: none"> • JDBC Thin Driver • JDBC Oracle Call Interface (OCI) Driver These drivers are typically installed during the installation of your Oracle database client. Connect through the OCI Driver (not the Thin Driver) if you are using the Oracle XML DB component. |
| | ODBC | <ul style="list-style-type: none"> • Microsoft ODBC for Oracle • Oracle ODBC Driver (typically installed during the installation of your Oracle database client) |
| PostgreSQL | JDBC | PostgreSQL JDBC Driver (https://jdbc.postgresql.org/download.html) |
| | ODBC | psqlODBC (https://odbc.postgresql.org/) |
| | Native connection | Available. No drivers are required. |
| Progress OpenEdge | JDBC | JDBC Connector (https://www.progress.com/jdbc/openedge) |
| | ODBC | ODBC Connector (https://www.progress.com/odbc/openedge) |
| SQLite | Native connection | Available. No drivers are required. |
| Sybase | ADO | Sybase ASE OLE DB Provider |
| | JDBC | jConnect™ for JDBC |
| | ODBC | Sybase ASE ODBC Driver |
| Teradata | ADO.NET | .NET Data Provider for Teradata
(https://downloads.teradata.com/download/connectivity/net-data-provider-for-teradata) |
| | JDBC | Teradata JDBC Driver
(https://downloads.teradata.com/download/connectivity/jdbc-driver) |
| | ODBC | Teradata ODBC Driver for Windows
(https://downloads.teradata.com/download/connectivity/odbc-driver/windows) |

17.1.3 ADO Connection

Microsoft ActiveX Data Objects (ADO) is a data access technology that enables you to connect to a variety of data sources through OLE DB. OLE DB is an alternative interface to ODBC or JDBC; it provides uniform access to data in a COM (Component Object Model) environment. ADO is a precursor of the newer [ADO.NET](#)⁶²¹ and is still one of the possible ways to connect to Microsoft native databases such as Microsoft Access or SQL Server, although you can also use it for other data sources.

Importantly, you can choose between multiple ADO providers, and some of them must be downloaded and installed on your workstation before you can use them. For example, for connecting to SQL Server, the following ADO providers are available:

- Microsoft OLE DB *Driver* for SQL Server (MSOLEDBSQL)
- Microsoft OLE DB *Provider* for SQL Server (SQLOLEDB)
- SQL Server Native Client (SQLNCLI)

From the providers listed above, the recommended one is MSOLEDBSQL; you can download it from <https://docs.microsoft.com/en-us/sql/connect/oledb/download-oledb-driver-for-sql-server?view=sql-server-ver15>. Note that it must match the platform of XMLSpy (32-bit or 64-bit). The SQLOLEDB and SQLNCLI providers are considered deprecated and thus are not recommended.

The **Microsoft OLE DB Provider for SQL Server (SQLOLEDB)** is known to have issues with parameter binding of complex queries like Common Table Expressions (CTE) and nested SELECT statements.

To set up an ADO connection:

1. [Start the database connection wizard](#)⁶¹⁰.
2. Click **ADO Connections**.

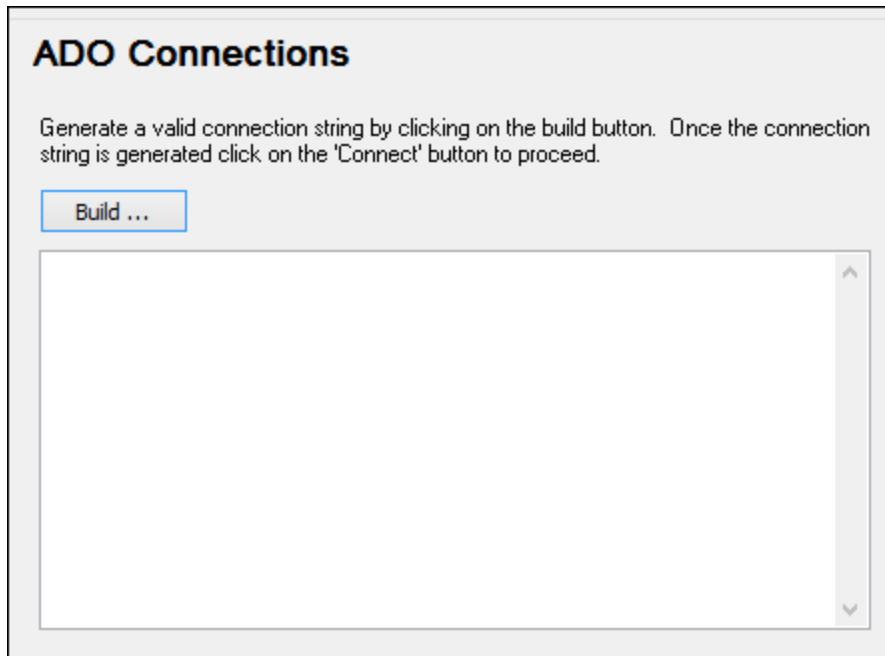

3. Click **Build**.

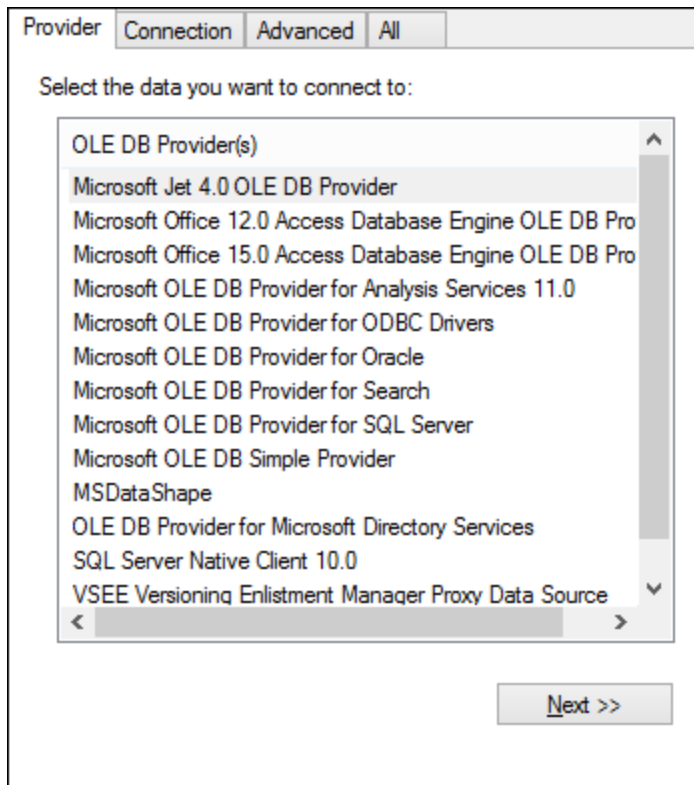

4. Select the data provider through which you want to connect. The table below lists a few common scenarios.

| To connect to this database... | Use this provider... |
|--------------------------------|--|
| Microsoft Access | <ul style="list-style-type: none"> • Microsoft Office Access Database Engine OLE DB Provider (recommended) • Microsoft Jet OLE DB Provider <p>If the Microsoft Office Access Database Engine OLE DB Provider is not available in the list, make sure that you have installed either Microsoft Access or the Microsoft Access Database Engine Redistributable (https://www.microsoft.com/en-us/download/details.aspx?id=54920) on your computer.</p> |
| SQL Server | <ul style="list-style-type: none"> • Microsoft OLE DB Driver for SQL Server (MSOLEDBSQL) - this is the recommended OLE DB provider. In order for this provider to appear in the list, it must be downloaded from https://docs.microsoft.com/en-us/sql/connect/oledb/download-oledb-driver-for-sql-server?view=sql-server-ver15 and installed. • Microsoft OLE DB Provider for SQL Server (OLEDBSQL) • SQL Server Native Client (SQLNCLI) |
| Other database | <p>Select the provider applicable to your database.</p> <p>If an OLE DB provider to your database is not available, install the required driver from the database vendor (see Database Drivers Overview⁶¹²). Alternatively, set up an ADO.NET, ODBC, or JDBC connection.</p> <p>If the operating system has an ODBC driver to the required database, you could also use the Microsoft OLE DB Provider for ODBC Drivers, or preferably opt for an ODBC connection⁶²⁸.</p> |

5. Having selected the provider of choice, click **Next** and complete the wizard.

The subsequent wizard steps are specific to the provider you chose. For SQL Server, you will need to provide or select the host name of the database server, the authentication method, the database name, as well as the database username and password. For an example, see [Connecting to Microsoft SQL Server \(ADO\)](#)⁶⁶³. For Microsoft Access, you will be asked to browse for or provide the path to the database file. For an example, see [Connecting to Microsoft Access \(ADO\)](#)⁶⁶⁰.

The complete list of initialization properties (connection parameters) is available in the **All** tab of the connection dialog box—these properties vary depending on the chosen provider and may need to be set explicitly in order for the connection to be possible. The following sections provide guidance on configuring the basic initialization properties for Microsoft Access and SQL Server databases:

- [Setting up the SQL Server Data Link Properties](#)⁶¹⁹
- [Setting up the Microsoft Access Data Link Properties](#)⁶²⁰

17.1.3.1 Connecting to an Existing Microsoft Access Database

This approach is suitable when you want to connect to a Microsoft Access database which is not password-protected. If the database is password-protected, set up the database password as shown in [Connecting to Microsoft Access \(ADO\)](#)⁶⁶⁰.

To connect to an existing Microsoft Access database:

1. Run the database connection wizard (see [Starting the Database Connection Wizard](#)⁶¹⁰).
2. Select **Microsoft Access (ADO)**, and then click **Next**.

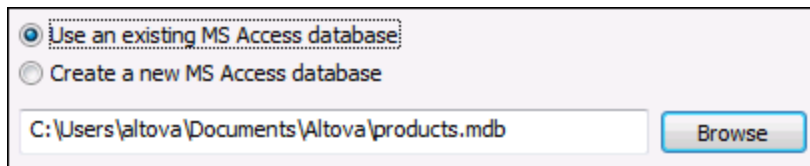

3. Select **Use an existing MS Access database**.
4. Browse for the database file, or enter the path to it (either relative or absolute).
5. Click **Connect**.

17.1.3.2 Creating a New Microsoft Access Database

As an alternative to connecting to an existing database file, you can create a new Microsoft Access database file (.accdb, .mdb) and connect to it, even if Microsoft Access is not installed on the computer. The database file created by XMLSpy is empty. To create the required database structure, use Microsoft Access or a tool such as DatabaseSpy (<https://www.altova.com/databasespy>).

To create a new Microsoft Access database:

1. Run the database connection wizard (see [Starting the Database Connection Wizard](#)⁶¹⁰).
2. Select **Microsoft Access (ADO)**, and then click **Next**.

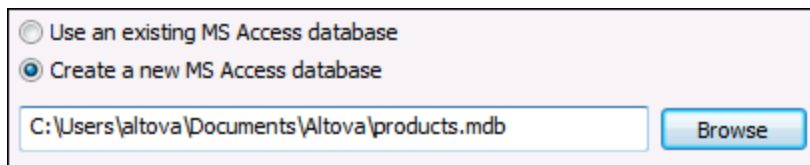

3. Select **Create a new MS Access database**, and then enter the path (either relative or absolute) of the database file to be created (for example, `c:\users\public\products.mdb`). Alternatively, click **Browse** to select a folder, type the name of the database file in the "File name" text box (for example, `products.mdb`), and click **Save**.

Notes

- Make sure that you have write permissions to the folder where you want to create the database file.
- The database file name must have the **.mdb** or **.accdb** extension.

4. Click **Connect**.

17.1.3.3 Setting up the SQL Server Data Link Properties

When you connect to a Microsoft SQL Server database through [ADO](#)⁶¹⁵, you may need to set the following connection properties in the **All** tab of the Data Link Properties dialog box.

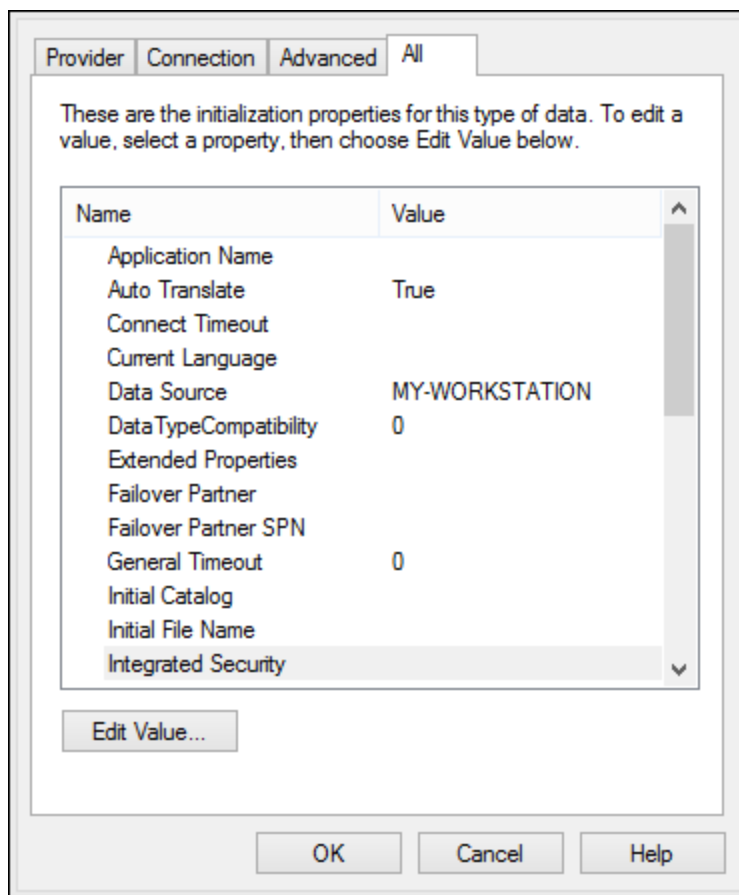

Data Link Properties dialog box

| Property | Notes |
|------------------------------|---|
| Integrated Security | If you selected the SQL Server Native Client data provider on the Provider tab, set this property to a space character. |
| Persist Security Info | Set this property to True . |

17.1.3.4 Setting up the Microsoft Access Data Link Properties

When you connect to a Microsoft Access database through [ADO](#)⁶¹⁵, you may need to set the following connection properties in the **All** tab of the Data Link Properties dialog box.

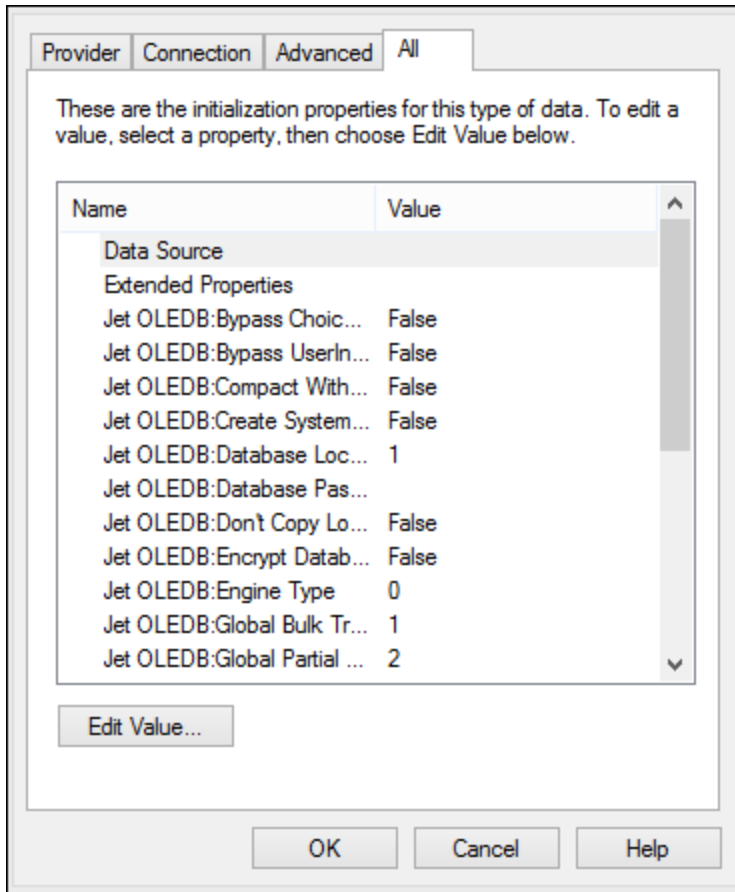

Data Link Properties dialog box

| Property | Notes |
|----------------------------------|--|
| Data Source | This property stores the path to the Microsoft Access database file. To avoid database connectivity issues, it is recommended to use the UNC (Universal Naming Convention) path format, for example:

<code>\\anyserver\share\$\filepath</code> |
| Jet OLEDB:System Database | This property stores the path to the workgroup information file. You may need to explicitly set the value of this property before you can connect to a Microsoft Access database.

If you cannot connect due to a "workgroup information file" error, locate the workgroup information file (System.MDW) applicable to your user profile, and set the property value to the path of the System.MDW file. |

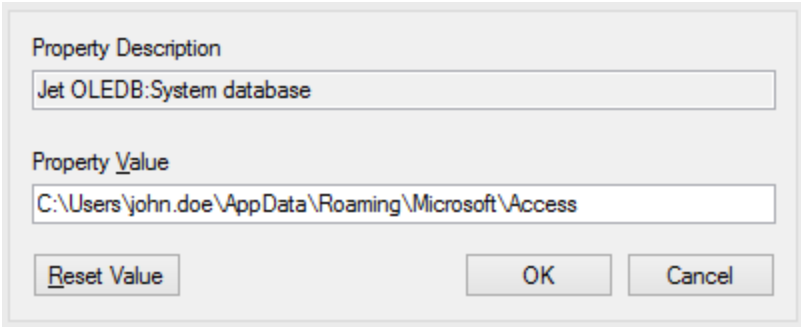
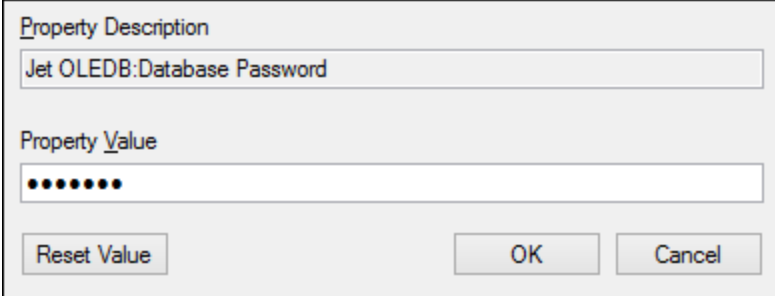
| Property | Notes |
|------------------------------------|--|
| |  |
| Jet OLEDB:Database Password | <p>If the database is password-protected, set the value of this property to the database password.</p>  |

17.1.4 ADO.NET Connection

ADO.NET is a set of Microsoft .NET Framework libraries designed to interact with data, including data from databases. To connect to a database from XMLSpy through ADO.NET, Microsoft .NET Framework 4 or later is required. As shown below, you connect to a database through ADO.NET by selecting a .NET provider and supplying a connection string.

A .NET data provider is a collection of classes that enables connecting to a particular type of data source (for example, a SQL Server, or an Oracle database), executing commands against it, and fetching data from it. In other words, with ADO.NET, an application such as XMLSpy interacts with a database through a data provider. Each data provider is optimized to work with the specific type of data source that it is designed for. There are two types of .NET providers:

1. Supplied by default with Microsoft .NET Framework.
2. Supplied by major database vendors, as an extension to the .NET Framework. Such ADO.NET providers must be installed separately and can typically be downloaded from the website of the respective database vendor.

Note: Certain ADO.NET providers are not supported or have limited support. See [ADO.NET Support Notes](#) ⁶²⁷.

To set up an ADO.NET connection:

1. [Start the database connection wizard](#) ⁶¹⁰.
2. Click **ADO.NET Connections**.
3. Select a .NET data provider from the list.

The list of providers available by default with the .NET Framework appears in the "Provider" list. Vendor-specific .NET data providers are available in the list only if they are already installed on your system. To become available, vendor-specific .NET providers must be installed into the GAC (Global Assembly Cache), by running the .msi or .exe file supplied by the database vendor.

4. Enter a database connection string. A connection string defines the database connection information, as semicolon-delimited key/value pairs of connection parameters. For example, a connection string such as `Data Source=DBSQLSERV;Initial Catalog=ProductsDB;UserID=dbuser;Password=dbpass` connects to the SQL Server database `ProductsDB` on server `DBSQLSERV`, with the user name `dbuser` and password `dbpass`. You can create a connection string by typing the key/value pairs directly into the "Connection String" dialog box. Another option is to create it with Visual Studio (see [Creating a Connection String in Visual Studio](#) ⁶²³).

The syntax of the connection string depends on the provider selected from the "Provider" list. For examples, see [Sample ADO.NET Connection Strings](#) ⁶²⁶.

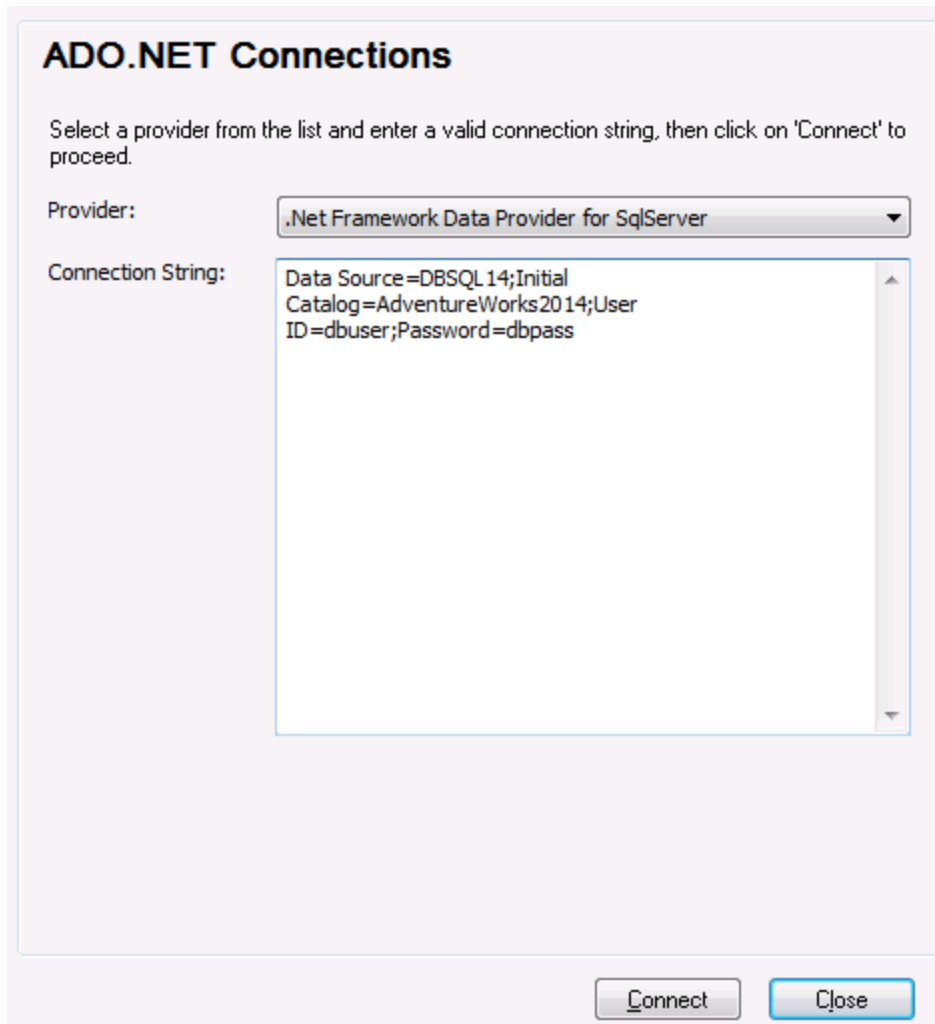

5. Click **Connect**.

17.1.4.1 Creating a Connection String in Visual Studio

In order to connect to a data source using ADO.NET, a valid database connection string is required. The following instructions show you how to create a connection string from Visual Studio.

To create a connection string in Visual Studio:

1. On the **Tools** menu, click **Connect to Database**.
2. Select a data source from the list (in this example, Microsoft SQL Server). The Data Provider is filled automatically based on your choice.

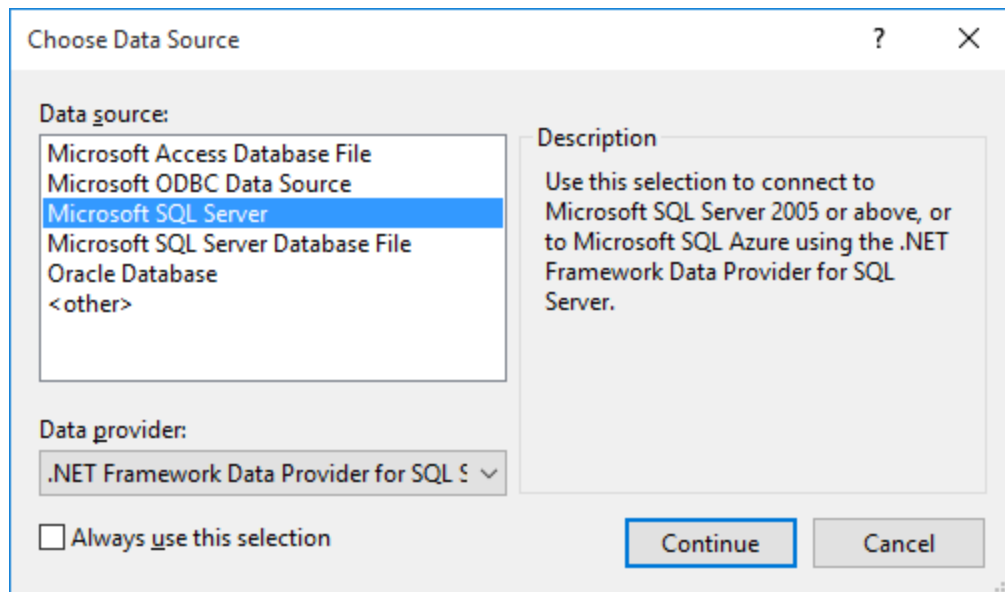

3. Click **Continue**.

Modify Connection

Enter information to connect to the selected data source or click "Change" to choose a different data source and/or provider.

Data source:
Microsoft SQL Server (SqlClient) Change...

Server name:
DBSQLSERV Refresh

Log on to the server

Use Windows Authentication

Use SQL Server Authentication

User name: dbuser

Password: ●●●●●●

Save my password

Connect to a database

Select or enter a database name:
ProductsDB

Attach a database file:
Browse...

Logical name:

Advanced...

Test Connection OK Cancel

4. Enter the server host name and the user name and password to the database. In this example, we are connecting to the database `ProductsDB` on server `DBSQLSERV`, using SQL Server authentication.
5. Click **OK**.

If the database connection is successful, it appears in the Server Explorer window. You can display the Server Explorer window using the menu command **View | Server Explorer**. To obtain the database connection string, right-click the connection in the Server Explorer window, and select **Properties**. The connection string is now displayed in the Properties window of Visual Studio. Note that, before pasting the string into the "Connection String" box of XMLSpy, you will need to replace the asterisk (*) characters with the actual password.

17.1.4.2 Sample ADO.NET Connection Strings

To set up an ADO.NET connection, you need to select an ADO.NET provider from the database connection dialog box and enter a connection string (see also [Setting up an ADO.NET Connection](#)⁶²¹). Sample ADO.NET connection strings for various databases are listed below under the .NET provider where they apply.

.NET Data Provider for Teradata

This provider can be downloaded from Teradata website (<https://downloads.teradata.com/download/connectivity/net-data-provider-for-teradata>). A sample connection string looks as follows:

```
Data Source=ServerAddress;User Id=USER;Password=password;
```

.NET Framework Data Provider for IBM i

This provider is installed as part of *IBM i Access Client Solutions - Windows Application Package*. A sample connection string looks as follows:

```
DataSource=ServerAddress;UserID=user;Password=password;DataCompression=True;
```

For more information, see the ".NET Provider Technical Reference" help file included in the installation package above.

.NET Framework Data Provider for MySQL

This provider can be downloaded from MySQL website (<https://dev.mysql.com/downloads/connector/net/>). A sample connection string looks as follows:

```
Server=127.0.0.1;Uid=root;Pwd=12345;Database=test;
```

See also: <https://dev.mysql.com/doc/connector-net/en/connector-net-programming-connecting-connection-string.html>

.NET Framework Data Provider for SQL Server

A sample connection string looks as follows:

```
Data Source=DBSQLSERV;Initial Catalog=ProductsDB;User ID=dbuser;Password=dbpass
```

See also: [https://msdn.microsoft.com/en-us/library/ms254500\(v=vs.110\).aspx](https://msdn.microsoft.com/en-us/library/ms254500(v=vs.110).aspx)

IBM DB2 Data Provider 10.1.2 for .NET Framework 4.0

```
Database=PRODUCTS;UID=user;Password=password;Server=localhost:50000;
```

Note: This provider is typically installed with the IBM DB2 Data Server Client package. If the provider is missing from the list of ADO.NET providers after installing IBM DB2 Data Server Client package, refer to the following technical note: <https://www-01.ibm.com/support/docview.wss?uid=swg21429586>.

See also:

https://www.ibm.com/support/knowledgecenter/en/SSEPGG_10.1.0/com.ibm.swg.im.dbclient.adonet.ref.doc/doc/DB2ConnectionClassConnectionStringProperty.html

Oracle Data Provider for .NET (ODP.NET)

The installation package which includes the ODP.NET provider can be downloaded from the Oracle website (see <http://www.oracle.com/technetwork/topics/dotnet/downloads/index.html>). A sample connection string looks as follows:

```
Data Source=DSORCL;User Id=user;Password=password;
```

Where `DSORCL` is the name of the data source which points to an Oracle service name defined in the `tnsnames.ora` file, as described in [Connecting to Oracle \(ODBC\)](#)⁶⁷⁵.

To connect without configuring a service name in the `tnsnames.ora` file, use a string such as:

```
Data Source=(DESCRIPTION=(ADDRESS_LIST=(ADDRESS=(PROTOCOL=TCP)(HOST=host)(PORT=port)))
(CONNECT_DATA=(SERVER=DEDICATED)(SERVICE_NAME=MyOracleSID)));User
Id=user;Password=password;
```

See also: https://docs.oracle.com/cd/B28359_01/win.111/b28375/featConnecting.htm

17.1.4.3 ADO.NET Support Notes

The following table lists known ADO.NET database drivers that are currently not supported or have limited support in XMLSpy.

| Database | Driver | Support notes |
|---------------|---|--|
| All databases | .Net Framework Data Provider for ODBC | Limited support. Known issues exist with Microsoft Access connections. It is recommended to use ODBC direct connections instead. |
| | .Net Framework Data Provider for OleDb | Limited support. Known issues exist with Microsoft Access connections. It is recommended to use ADO direct connections instead. |
| Firebird | Firebird ADO.NET Data Provider | Limited support. It is recommended to use ODBC or JDBC instead. |
| Informix | IBM Informix Data Provider for | Not supported. Use DB2 Data Server |

| Database | Driver | Support notes |
|-------------------------|--|---|
| | .NET Framework 4.0 | Provider instead. |
| IBM DB2 for i (iSeries) | .Net Framework Data Provider for i5/OS | Not supported. Use .Net Framework Data Provider for IBM i instead, installed as part of the <i>IBM i Access Client Solutions - Windows Application Package</i> . |
| Oracle | .Net Framework Data Provider for Oracle | Limited support. Although this driver is provided with the .NET Framework, its usage is discouraged by Microsoft, because it is deprecated. |
| PostgreSQL | - | No ADO.NET drivers for this vendor are supported. Use a native connection instead. |
| Sybase | - | No ADO.NET drivers for this vendor are supported. |

17.1.5 ODBC Connection

ODBC (Open Database Connectivity) is a widely used data access technology that enables you to connect to a database from XMLSpy. It can be used either as primary means to connect to a database, or as an alternative to native, OLE DB, or JDBC-driven connections.

To connect to a database through ODBC, first you need to create an ODBC data source name (DSN) on the operating system. This step is not required if the DSN has already been created, perhaps by another user of the operating system. The DSN represents a uniform way to describe the database connection to any ODBC-aware client application on the operating system, including XMLSpy. DSNs can be of the following types:

- System DSN
- User DSN
- File DSN

A *System* data source is accessible by all users with privileges on the operating system. A *User* data source is available to the user who created it. Finally, if you create a *File DSN*, the data source will be created as a file with the *.dsn* extension which you can share with other users, provided that they have installed the drivers used by the data source.

Any DSNs already available on your machine are listed by the database connection dialog box when you click **ODBC connections** on the ODBC connections dialog box.

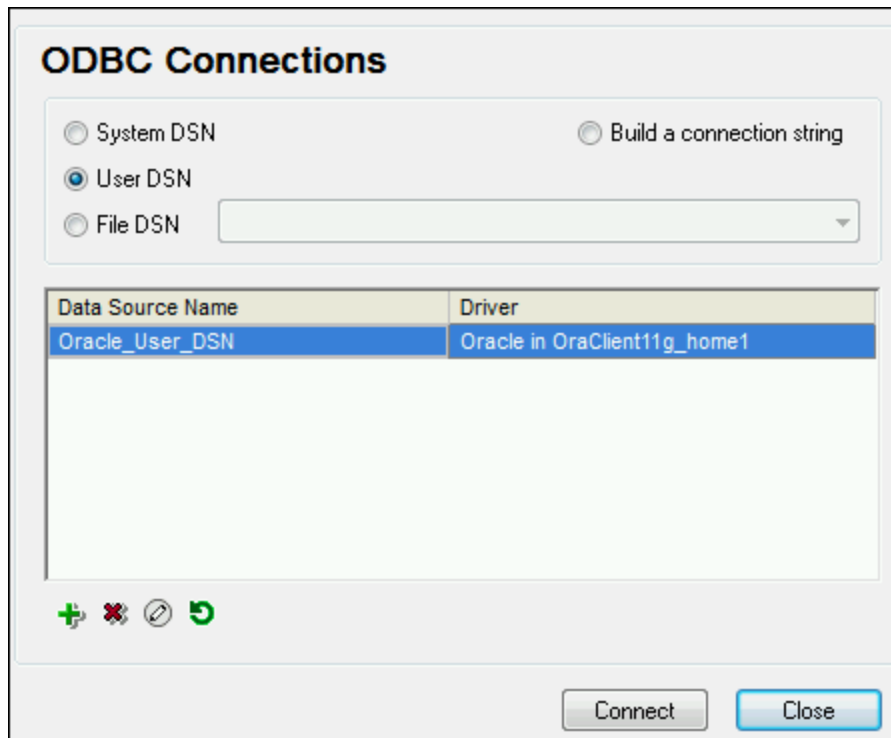

ODBC Connections dialog box

If a DSN to the required database is not available, the XMLSpy database connection wizard will assist you to create it; however, you can also create it directly on your Windows operating system. In either case, before you proceed, ensure that the ODBC driver applicable for your database is in the list of ODBC drivers available to the operating system (see [Viewing the Available ODBC Drivers](#)⁶³⁰).

To connect by using a new DSN:

1. [Start the database connection wizard](#)⁶¹⁰.
2. On the database connection dialog box, click **ODBC Connections**.
3. Select a data source type (User DSN, System DSN, File DSN).

To create a System DSN, you need administrative rights on the operating system, and XMLSpy must be run as administrator.

4. Click **Add** .
5. Select a driver, and then click **User DSN** or **System DSN** (depending on the type of the DSN you want to create). If the driver applicable to your database is not listed, download it from the database vendor and install it (see [Database Drivers Overview](#)⁶¹²).
6. On the dialog box that pops up, fill in any driver specific connection information to complete the setup.

For the connection to be successful, you will need to provide the host name (or IP address) of the database server, as well as the database username and password. There may be other optional connection parameters—these parameters vary between database providers. For detailed information about the parameters specific to

each connection method, consult the documentation of the driver provider. Once created, the DSN becomes available in the list of data source names. This enables you to reuse the database connection details any time you want to connect to the database. Note that User DSNs are added to the list of User DSNs whereas System DSNs are added to the list of System DSNs.

To connect by using an existing DSN:

1. [Start the database connection wizard](#) ⁶¹⁰.
2. Click **ODBC Connections**.
3. Choose the type of the existing data source (User DSN, System DSN, File DSN).
4. Click the existing DSN record, and then click **Connect**.

To build a connection string based on an existing .dsn file:

1. [Start the database connection wizard](#) ⁶¹⁰.
2. Click **ODBC Connections**.
3. Select **Build a connection string**, and then click **Build**.
4. If you want to build the connection string using a File DSN, click the **File Data Source** tab. Otherwise, click the **Machine Data Source** tab. (System DSNs and User DSNs are known as "Machine" data sources.)
5. Select the required .dsn file, and then click **OK**.

To connect by using a prepared connection string:

1. [Start the database connection wizard](#) ⁶¹⁰.
2. Click **ODBC Connections**.
3. Select **Build a connection string**.
4. Paste the connection string into the provided box, and then click **Connect**.

17.1.5.1 Available ODBC Drivers

You can view the ODBC drivers available on your operating system in the ODBC Data Source Administrator. You can access the ODBC Data Source Administrator (**Odbcad32.exe**) from the Windows Control Panel, under **Administrative Tools**. On 64-bit operating systems, there are two versions of this executable:

- The 32-bit version of the **Odbcad32.exe** file is located in the **C:\Windows\SysWoW64** directory (assuming that **C:** is your system drive).
- The 64-bit version of the **Odbcad32.exe** file is located in the **C:\Windows\System32** directory.

Any installed 32-bit database drivers are visible in the 32-bit version of ODBC Data Source Administrator, while 64-bit drivers—in the 64-bit version. Therefore, ensure that you check the database drivers from the relevant version of ODBC Data Source Administrator.

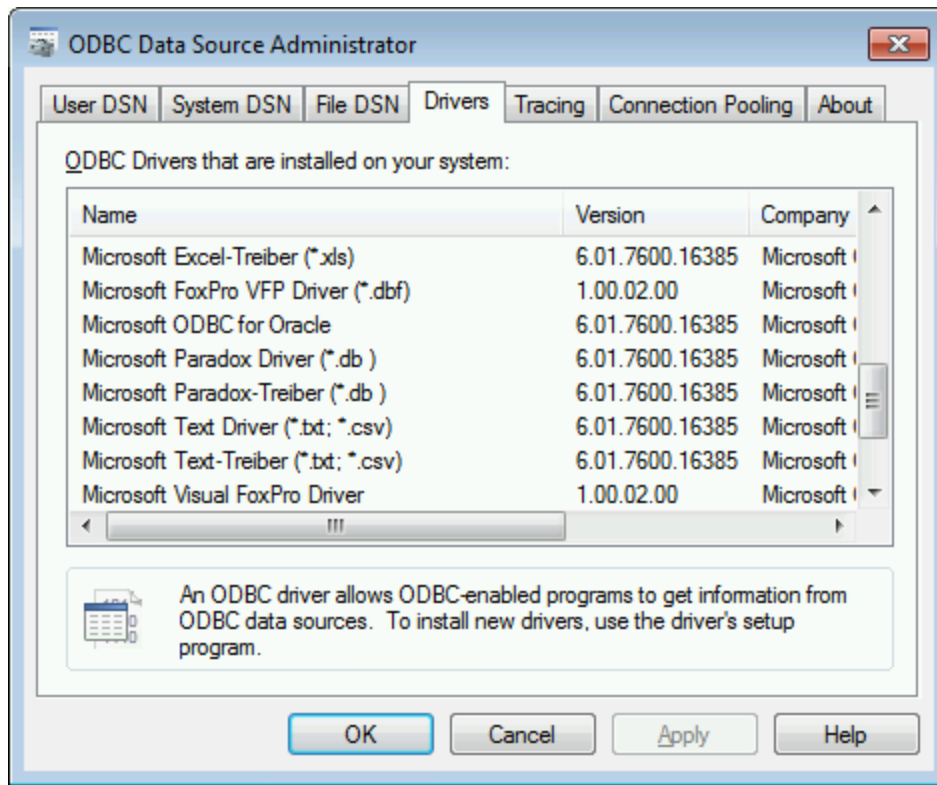

ODBC Data Source Administrator

If the driver to your target database does not exist in the list, or if you want to add an alternative driver, you will need to download it from the database vendor (see [Database Drivers Overview](#)⁶¹²). Once the ODBC driver is available on your system, you are ready to create ODBC connections with it (see [Setting up an ODBC Connection](#)⁶²⁸).

17.1.6 JDBC Connection

JDBC (Java Database Connectivity) is a database access interface which is part of the Java software platform from Oracle. JDBC connections are generally more resource-intensive than ODBC connections but may provide features not available through ODBC.

Prerequisites

- JRE (Java Runtime Environment) or Java Development Kit (JDK) must be installed. This may be either Oracle JDK or an open source build such as Oracle OpenJDK. XMLSpy will determine the path to the Java Virtual Machine (JVM) from the following locations, in this order: a) The custom JVM path you may have set in application **Options**; b) The JVM path found in the Windows registry; c) The `JAVA_HOME` environment variable.
- Make sure that the platform of XMLSpy (32-bit, 64-bit) matches that of the JRE/JDK.
- The JDBC drivers from the database vendor must be installed. These may be JDBC drivers installed as part of a database client installation, or JDBC libraries (.jar files) downloaded separately, if available and supported by the database, see also [Database Connection Examples](#)⁶⁴⁰.

- The `CLASSPATH` environment variable must include the path to the JDBC driver (one or several `.jar` files) on your Windows operating system. When you install some database clients, the installer may configure this variable automatically. See also [Configuring the CLASSPATH](#) ⁶³⁴.

Connecting to SQL Server via JDBC with Windows credentials

If you connect to SQL Server through JDBC with Windows credentials (integrated security), note the following:

- The `sqljdbc_auth.dll` file included in the JDBC driver package must be copied to a directory that is on the system `PATH` environment variable. There are two such files, one for the x86 and one for x64 platform. Make sure that you add to the `PATH` the one that corresponds to your JDK platform.
- The JDBC connection string must include the property `integratedSecurity=true`.

For further information, refer to *Microsoft JDBC driver for SQL Server* documentation, <https://docs.microsoft.com/en-us/sql/connect/jdbc/building-the-connection-url>.

Setting up a JDBC connection

1. [Start the database connection wizard](#) ⁶¹⁰.
2. Click **JDBC Connections**.
3. Optionally, enter a semicolon-separated list of `.jar` file paths in the "Classpaths" text box. The `.jar` libraries entered here will be loaded into the environment in addition to those already defined in the `CLASSPATH` environment variable. When you finish editing the "Classpaths" text box, any JDBC drivers found in the source `.jar` libraries are automatically added to the "Driver" list (see the next step).

The screenshot shows a dialog box for configuring a JDBC connection. It has the following fields and values:

- Classpaths:** `C:\jdbc\instantclient_12_1\ojdbc7.jar`
- Driver:** `oracle.jdbc.driver.OracleDriver`
- Username:** `johndoe`
- Password:** Masked with 7 dots
- Database URL:** `jdbc:oracle:thin:@//ora12c:1521/orcl12c`

At the bottom of the dialog are two buttons: **Connect** and **Close**.

- Next to "Driver", select a JDBC driver from the list, or enter a Java class name. Note that this list contains any JDBC drivers configured through the CLASSPATH environment variable (see [Configuring the CLASSPATH](#) ⁶³⁴), as well as those found in the "Classpaths" text box.

The JDBC driver paths defined in the CLASSPATH variable, as well as any .jar file paths entered directly in the database connection dialog box are all supplied to the Java Virtual Machine (JVM). The JVM then decides which drivers to use in order to establish a connection. It is recommended to keep track of Java classes loaded into the JVM so as not to create potential JDBC driver conflicts and avoid unexpected results when connecting to the database.

- Enter the username and password to the database in the corresponding boxes.
- In the Database URL text box, enter the JDBC connection URL (string) in the format specific to your database type. The following table describes the syntax of JDBC connection URLs (strings) for common database types.

| Database | JDBC Connection URL |
|----------------------|--|
| Firebird | <code>jdbc:firebirdsql://<host>[:<port>]/<database path or alias></code> |
| IBM DB2 | <code>jdbc:db2://<hostName>:<port>/<databaseName></code> |
| IBM DB2 for i | <code>jdbc:as400://<[host]></code> |
| IBM Informix | <code>jdbc:informix-sqli://<hostName>:<port>/<databaseName>:INFORMIXSERVER=<myserver></code> |
| MariaDB | <code>jdbc:mariadb://<hostName>:<port>/<databaseName></code> |
| Microsoft SQL Server | <code>jdbc:sqlserver://<hostName>:<port>;<databaseName>=name</code> |
| MySQL | <code>jdbc:mysql://<hostName>:<port>/<databaseName></code> |
| Oracle | <code>jdbc:oracle:thin:@<hostName>:<port>:<SID></code>
<code>jdbc:oracle:thin:@//<hostName>:<port>/<service></code> |
| Oracle XML DB | <code>jdbc:oracle:oci:@//<hostName>:<port>:<service></code> |
| PostgreSQL | <code>jdbc:postgresql://<hostName>:<port>/<databaseName></code> |
| Progress OpenEdge | <code>jdbc:datadirect:openedge://<host>:<port>;<databaseName>=<db_name></code> |
| Sybase | <code>jdbc:sybase:Tds:<hostName>:<port>/<databaseName></code> |
| Teradata | <code>jdbc:teradata://<databaseServerName></code> |

Note: Syntax variations to the formats listed above are also possible (for example, the database URL may exclude the port or may include the username and password to the database). Check the documentation of the database vendor for further details.

- Click **Connect**.

17.1.6.1 Configuring the CLASSPATH

The `CLASSPATH` environment variable is used by the Java Runtime Environment (JRE) or the Java Development Kit (JDK) to locate Java classes and other resource files on your operating system. When you connect to a database through JDBC, this variable must be configured to include the path to the JDBC driver on your operating system, and, in some cases, the path to additional library files specific to the database type you are using.

The following table lists sample file paths that must be typically included in the `CLASSPATH` variable. Importantly, you may need to adjust this information based on the location of the JDBC driver on your system, the JDBC driver name, as well as the JRE/JDK version present on your operating system. To avoid connectivity problems, check the installation instructions and any pre-installation or post-installation configuration steps applicable to the JDBC driver installed on your operating system.

| Database | Sample CLASSPATH entries |
|----------------------|---|
| Firebird | C:\Program Files\Firebird\Jaybird-2.2.8-JDK_1.8\jaybird-full-2.2.8.jar |
| IBM DB2 | C:\Program Files (x86)\IBM\SQLLIB\java\db2jcc.jar;C:\Program Files (x86)\IBM\SQLLIB\java\db2jcc_license_cu.jar; |
| IBM DB2 for i | C:\jt400\jt400.jar; |
| IBM Informix | C:\Informix_JDBC_Driver\lib\ifxjdbc.jar; |
| Microsoft SQL Server | C:\Program Files\Microsoft JDBC Driver 4.0 for SQL Server\sqljdbc_4.0\enu\sqljdbc.jar |
| MariaDB | <installation directory>\mariadb-java-client-2.2.0.jar |
| MySQL | <installation directory>\mysql-connector-java- <i>version</i> -bin.jar; |
| Oracle | ORACLE_HOME\jdbc\lib\ojdbc6.jar; |
| Oracle (with XML DB) | ORACLE_HOME\jdbc\lib\ojdbc6.jar;ORACLE_HOME\LIB\xmlparserv2.jar;ORACLE_HOME\RDBMS\jlib\xdb.jar; |
| PostgreSQL | <installation directory>\postgresql.jar |
| Progress OpenEdge | %DLC%\java\openedge.jar;%DLC%\java\pool.jar;

Note: Assuming the Progress OpenEdge SDK is installed on the machine, %DLC% is the directory where OpenEdge is installed. |
| Sybase | C:\sybase\jConnect-7_0\classes\jconn4.jar |
| Teradata | <installation directory>\tdgssconfig.jar;<installation directory>\terajdbc4.jar |

- Changing the CLASSPATH variable may affect the behavior of Java applications on your machine. To understand possible implications before you proceed, refer to the Java documentation.
- Environment variables can be user or system. To change system environment variables, you need administrative rights on the operating system.
- After you change the environment variable, restart any running programs for settings to take effect. Alternatively, log off or restart your operating system.

To configure the CLASSPATH on Windows 7:

1. Open the **Start** menu and right-click **Computer**.
2. Click **Properties**.
3. Click **Advanced system settings**.
4. In the **Advanced** tab, click **Environment Variables**.
5. Locate the CLASSPATH variable under user or system environment variables, and then click **Edit**. If the CLASSPATH variable does not exist, click **New** to create it.
6. Edit the variable value to include the path on your operating system where the JDBC driver is located. To separate the JDBC driver path from other paths that may already be in the CLASSPATH variable, use the semi-colon separator (;).

To configure the CLASSPATH on Windows 10:

1. Press the Windows key and start typing "environment variables".
2. Click the suggestion **Edit the system environment variables**.
3. Click **Environment Variables**.
4. Locate the CLASSPATH variable under user or system environment variables, and then click **Edit**. If the CLASSPATH variable does not exist, click **New** to create it.
5. Edit the variable value to include the path on your operating system where the JDBC driver is located. To separate the JDBC driver path from other paths that may already be in the CLASSPATH variable, use the semi-colon separator (;).

17.1.7 SQLite Connection

[SQLite](#) is a file-based, self-contained database type, which makes it ideal in scenarios where portability and ease of configuration is important. Since SQLite databases are natively supported by XMLSpy, you do not need to install any drivers to connect to them.

SQLite database support notes

- On Linux, statement execution timeout for SQLite databases is not supported.
- Full text search tables are not supported.
- SQLite allows values of different data types in each row of a given table. All processed values must be compatible with the declared column type; therefore, unexpected values can be retrieved and run-time errors may occur if your SQLite database has row values which are not the same as the declared column type.

Important

It is recommended to create tables with the `STRICT` keyword to ensure more predictable behavior of your data. Otherwise, the data may not be read or written correctly when values of different types are mixed in one column. To find out more about STRICT tables, see the [SQLite documentation](#).

17.1.7.1 Connect to an Existing SQLite Database

You can connect to an existing SQLite database either using the connection wizard, or directly from Windows Explorer, by using the **Open With...** command.

Using the Connection Wizard

To connect to an existing SQLite database:

1. Run the database connection wizard (see [Starting the Database Connection Wizard](#)⁶¹⁰).
2. Select **SQLite**, and then click **Next**.

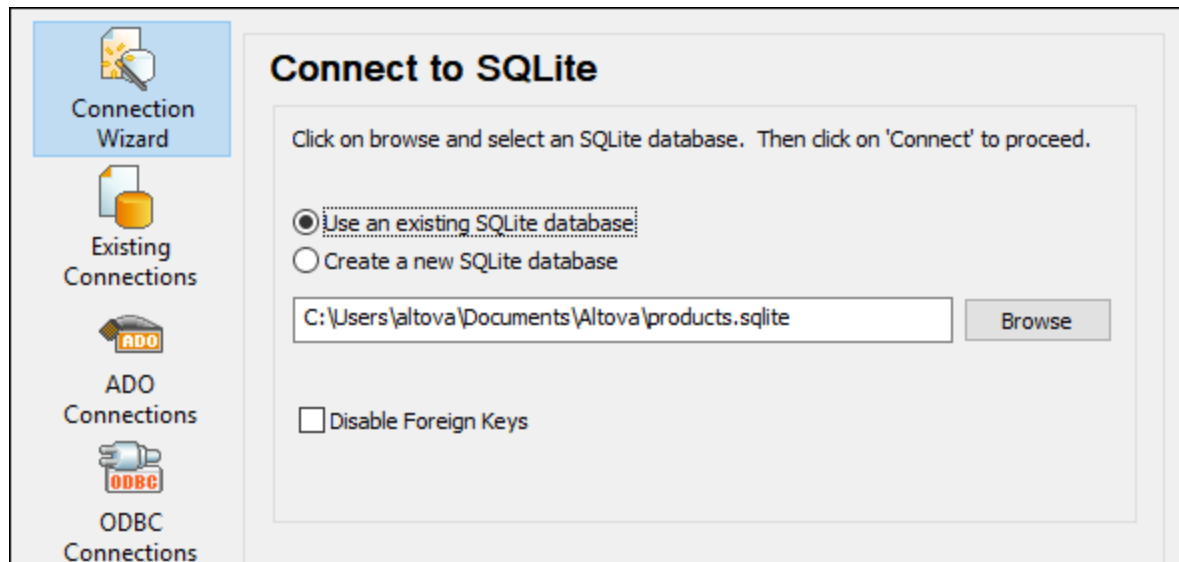

3. Select **Use an existing SQLite database**, and then browse for the SQLite database file, or enter the path (either relative or absolute) to the database. The **Connect** button becomes enabled once you enter the path to a SQLite database file.
4. Optionally, select the **Disable Foreign Keys** check box, see [Foreign Key Constraints](#)⁶³⁸.
5. Click **Connect**.

From Windows Explorer

You can also open a SQLite database directly from Windows Explorer, as follows:

1. Right-click an existing database file in Windows Explorer and select **Open With** from the context menu.
2. Choose **DatabaseSpy** from the list of suggestions. If this suggestion is not available, select **Choose another app**, and browse for the DatabaseSpy executable from the installation directory.
3. If the Database Connection Wizard appears, click **Close** to disregard it.

You can also drag and drop the database file into DatabaseSpy if the latter is already open.

Notes:

- You can optionally configure DatabaseSpy from **Tools | Options** so as not to show the Database Connection Wizard whenever the application starts. To do this, clear the check box **Show create a database connection dialog** in the **General** group of settings.
- If DatabaseSpy is open and a data source to the same database file already exists, it will be reused. In other words, a duplicate data source to the same database will not be created. This is applicable both when opening a database file with **Open With** and when using drag and drop.

17.1.7.2 Create a New SQLite Database

You can create a new SQLite database file and connect to it, as an alternative to connecting to an existing database file. The database file created by XMLSpy is empty; use queries or scripts to create the required database structure and populate it with data.

To create a new SQLite database:

1. Run the database connection wizard (see [Starting the Database Connection Wizard](#)⁶¹⁰).
2. Select **SQLite**, and then click **Next**.

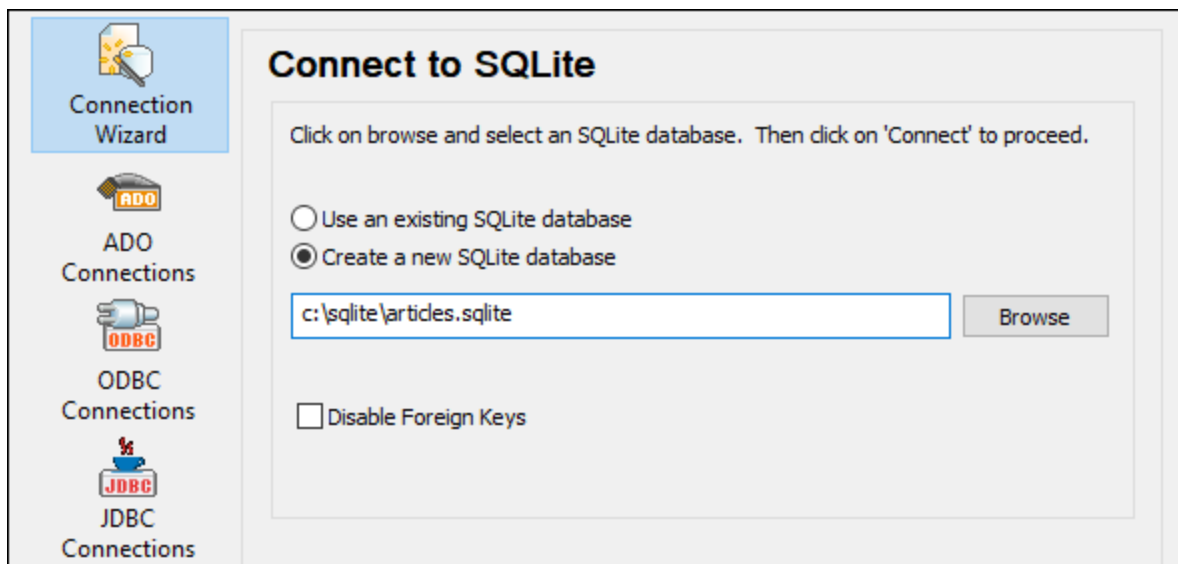

3. Select **Create a new SQLite database**, and then enter the path (either relative or absolute) of the database file to be created (for example, `c:\users\public\products.sqlite`). Alternatively, click **Browse** to select a folder, type the name of the database file in the "File name" text box (for example, `products.sqlite`), and click **Save**.

Make sure that you have write permissions to the folder where you want to create the database file.

4. Optionally, select the **Disable Foreign Keys** check box, see [Foreign Key Constraints](#) ⁶³⁸.
5. Click **Connect**.

17.1.7.3 Foreign Key Constraints

When you connect to an existing SQLite database from XMLSpy, or when you create a new one, foreign key constraints are enabled by default. Foreign key constraints help preserve the integrity of data in your database. For example, when foreign keys are enabled, it is not possible to delete a record from a table if it has dependencies in another table.

In certain cases, you may want to temporarily override this behavior and disable foreign keys, perhaps, in order to update or insert multiple rows of data without getting data validation errors. To explicitly disable foreign keys before connecting to the SQLite database, select the **Disable Foreign Keys** option available on the database connection wizard.

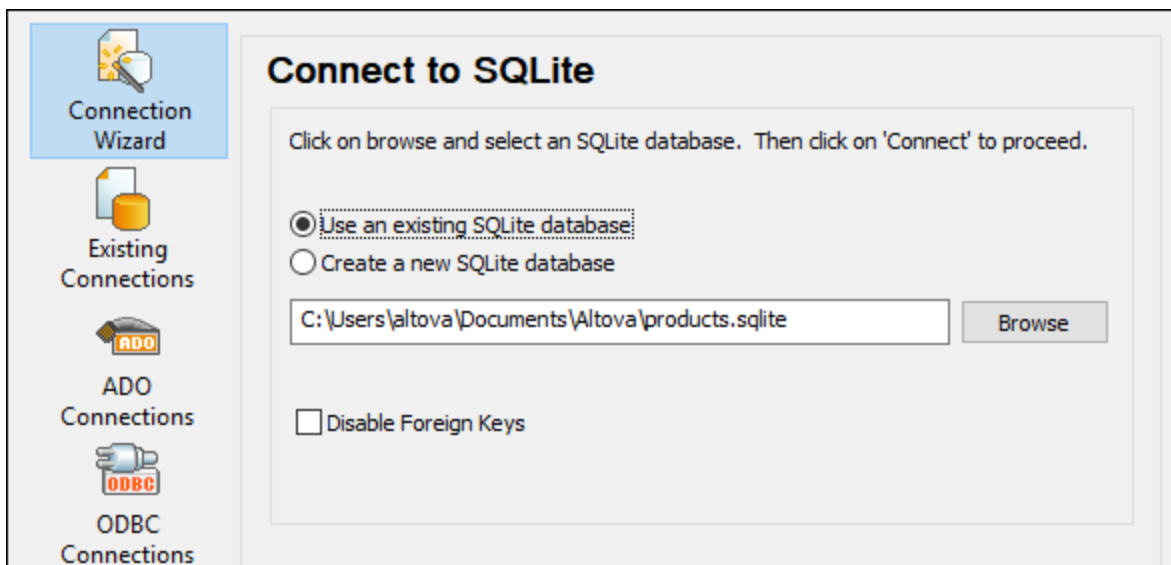

"Connect to SQLite" wizard page

When foreign keys are disabled, you will be able to perform operations against data that would otherwise not be possible due to validation checks. At the same time, however, there is also the risk of introducing incorrect data into the database, or creating "orphaned" rows. (An example of an "orphaned" row would be an address in the "addresses" table not linked to any person in the "person" table, because the person was deleted but its associated address was not.)

17.1.8 Native Connection

Native connections are direct connections to the DB that do not need drivers to be installed.

You can set up native connections for the following DBs:

- MariaDB

- MySQL
- SQLite
- PostgreSQL

If you prefer to establish a connection by means of a driver, see the following topics:

- [Setting up a JDBC Connection](#) ⁶³¹
- [SQLite Connection](#) ⁶³⁵
- [Connecting to PostgreSQL \(ODBC\)](#) ⁶⁷⁹

Connection setup

To set up a native connection, follow the steps below. You will need the following information: host name, port, database name, username, and password.

1. [Start the database connection wizard](#) ⁶¹⁰.
2. Select the DB you want to connect to (MariaDB, MySQL, PostgreSQL, or SQLite).
3. In the dialog that appears, enter the host (for example, *localhost*), optionally the port (typically 5432), SSL Mode in the case of MySQL, the database name, username, and password in the corresponding boxes.
4. Click **Connect**.

SQLite connections

For detailed information about SQLite connections, see the topic [SQLite Connection](#) ⁶³⁵.

Notes for PostgreSQL

If the PostgreSQL database server is on a different machine, note the following:

- The PostgreSQL database server must be configured to accept connections from clients. Specifically, the **pg_hba.conf** file must be configured to allow non-local connections. Secondly, the **postgresql.conf** file must be configured to listen on specified IP address(es) and port. For more information, check the PostgreSQL documentation (<https://www.postgresql.org/docs/9.5/static/client-authentication-problems.html>).
- The server machine must be configured to accept connections on the designated port (typically, 5432) through the firewall. For example, on a database server running on Windows, a rule may need to be created to allow connections on port 5432 through the firewall, from **Control Panel > Windows Firewall > Advanced Settings > Inbound Rules**.

17.1.9 Global Resources

After you have created a database as a global resource, its connection details are stored and can be used across all Altova products installed on your machine.

Create a database as a global resource

To create a database as a global resource, do the following

1. On the **Tools** menu of XMLSpy, click **Global Resources**.

2. Click **Add**, and then click Database.
3. Type in a name for the global resource in the *Resource Alias* field.
4. Click **Choose Database**. The [Connection Wizard](#)⁶¹⁰ appears.
5. Use the Connection Wizard to add a database connection as described above.

Use a global-resource database

To use a database that has been created as a global resource (see above), do the following:

1. Start the Connection Wizard as described above.
2. Select Global Resources. All the databases that have been created as global resources will be listed by their names in the Global Resources pane (see screenshot below).

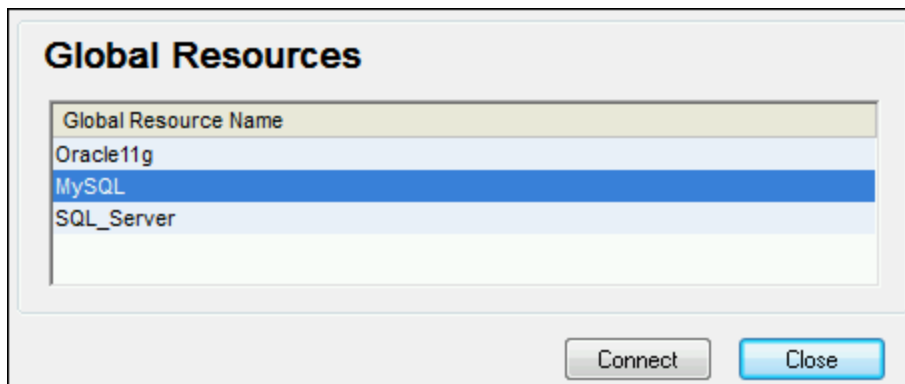

3. Select the global resource that you want. Tip: Move the mouse cursor over a global resource in the list to see information about the database.

17.1.10 Database Connection Examples

This section includes examples for connecting to a database from XMLSpy through ADO, ODBC, or JDBC. The ADO.NET connection examples are listed separately, see [Sample ADO.NET Connection Strings](#)⁶²⁶. For instructions about establishing a native connection to PostgreSQL and SQLite, see [Setting up a PostgreSQL Connection](#)⁶³⁸ and [Setting up a SQLite Connection](#)⁶³⁵, respectively.

Note the following:

- The instructions may differ if your Windows configuration, network environment and the database client or server software are not the same as the ones described in each example.
- For most database types, it is possible to connect using more than one data access technology (ADO, ADO.NET, ODBC, JDBC) or driver. The performance of the database connection, as well as its features and limitations will depend on the selected driver, database client software (if applicable), and any additional connectivity parameters that you may have configured outside XMLSpy.

17.1.10.1 Firebird (JDBC)

This example illustrates how to connect to a Firebird database server through JDBC.

Prerequisites:

- JRE (Java Runtime Environment) or Java Development Kit (JDK) must be installed. This may be either Oracle JDK or an open source build such as Oracle OpenJDK. XMLSpy will determine the path to the Java Virtual Machine (JVM) from the following locations, in this order: a) The custom JVM path you may have set in application **Options**; b) The JVM path found in the Windows registry; c) The `JAVA_HOME` environment variable.
- Make sure that the platform of XMLSpy (32-bit, 64-bit) matches that of the JRE/JDK.
- The Firebird JDBC driver must be available on your operating system (it takes the form of a .jar file which provides connectivity to the database). The driver can be downloaded from the Firebird website (<https://www.firebirdsql.org/>). This example uses *Jaybird 2.2.8*.
- You have the following database connection details: host, database path or alias, username, and password.

To connect to Firebird through JDBC:

1. [Start the database connection wizard](#) ⁶¹⁰.
2. Click **JDBC Connections**.
3. Next to "Classpaths", enter the path to the .jar file which provides connectivity to the database. If necessary, you can also enter a semicolon-separated list of .jar file paths. In this example, the required .jar file is located at the following path: **C:\jdbc\firebird\jaybird-full-2.2.8.jar**. Note that you can leave the "Classpaths" text box empty if you have added the .jar file path(s) to the CLASSPATH environment variable of the operating system (see also [Configuring the CLASSPATH](#) ⁶³⁴).
4. In the "Driver" box, select **org.firebirdsql.jdbc.FBDriver**. Note that this entry is available if a valid .jar file path is found either in the "Classpath" text box, or in the operating system's CLASSPATH environment variable (see the previous step).

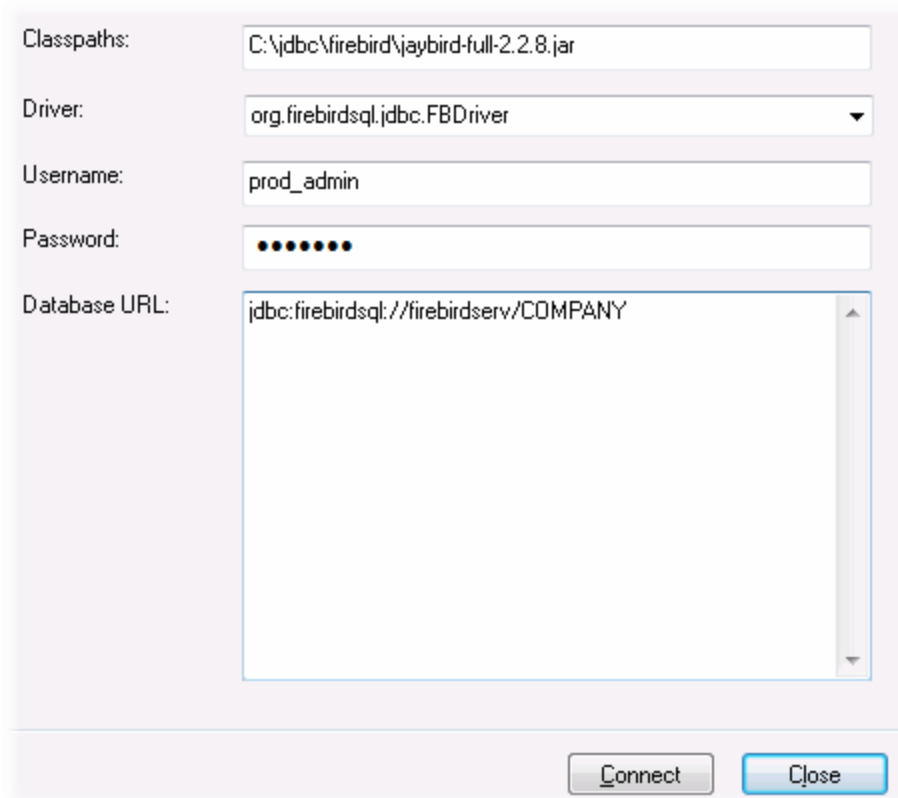

Classpaths: C:\jdbc\firebird\jaybird-full-2.2.8.jar

Driver: org.firebirdsql.jdbc.FBDriver

Username: prod_admin

Password: ●●●●●●

Database URL: jdbc:firebirdsql://firebirdserv/COMPANY

Connect Close

5. Enter the username and password to the database in the corresponding text boxes.
6. Enter the connection string to the database server in the Database URL text box, by replacing the highlighted values with the ones applicable to your database server.

```
jdbc:firebirdsql://<host>[:<port>]/<database path or alias>
```

7. Click **Connect**.

17.1.10.2 Firebird (ODBC)

This example illustrates how to connect to a Firebird 2.5.4 database running on a Linux server.

Prerequisites:

- The Firebird database server is configured to accept TCP/IP connections from clients.
- The Firebird ODBC driver must be installed on your operating system. This example uses the Firebird ODBC driver version 2.0.3.154 downloaded from the Firebird website (<https://www.firebirdsql.org/>).
- The Firebird client must be installed on your operating system. Note that there is no standalone installer available for the Firebird 2.5.4 client; the client is part of the Firebird server installation package. You can download the Firebird server installation package from the Firebird website (<https://www.firebirdsql.org/>), look for "Windows executable installer for full Superclassic/Classic or Superserver". To install only the client files, choose "**Minimum client install - no server, no tools**" when going through the wizard steps.

Important:

- The platform of both the Firebird ODBC driver and client (32-bit or 64-bit) must correspond to that of XMLSpy.
- The version of the Firebird client must correspond to the version of Firebird server to which you are connecting.

- You have the following database connection details: server host name or IP address, database path (or alias) on the server, user name, and password.

To connect to Firebird via ODBC:

1. [Start the database connection wizard](#) ⁶¹⁰.
2. Click **ODBC Connections**.
3. Select **User DSN** (or **System DSN**, if you have administrative privileges), and then click **Add** .

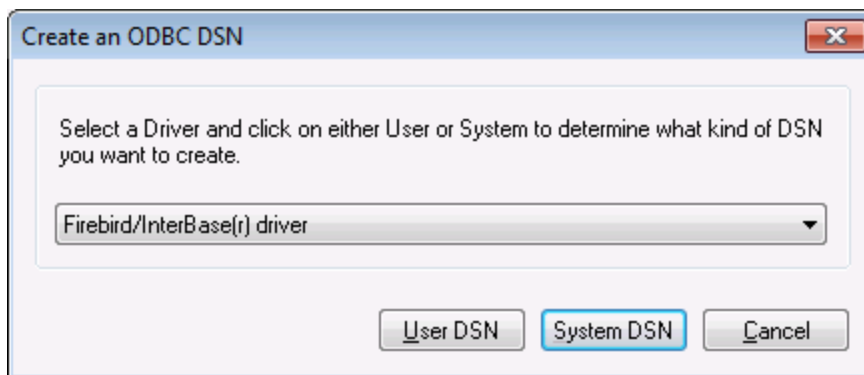

4. Select the Firebird driver, and then click **User DSN** (or **System DSN**, depending on what you selected in the previous step). If the Firebird driver is not available in the list, make sure that it is installed on your operating system (see also [Viewing the Available ODBC Drivers](#) ⁶³⁰).

5. Enter the database connection details as follows:

| | |
|-------------------------------|---|
| <i>Data Source Name (DSN)</i> | Enter a descriptive name for the data source you are creating. |
| <i>Database</i> | <p>Enter the server host name or IP address, followed by a colon, followed by the database alias (or path). In this example, the host name is <code>firebirdserv</code>, and the database alias is <code>products</code>, as follows:</p> <pre>firebirdserv:products</pre> <p>Using a database alias assumes that, on the server side, the database administrator has configured the alias <i>products</i> to point to the actual Firebird (.fdb) database file on the server (see the Firebird documentation for more details).</p> <p>You can also use the server IP address instead of the host name, and a path instead of an alias; therefore, any of the following sample connection strings are valid:</p> <pre>firebirdserver:/var/Firebird/databases/butterflies.fdb 127.0.0.1:D:\Misc\Lenders.fdb</pre> |

| | |
|-------------------------|---|
| | If the database is on the local Windows machine, click Browse and select the Firebird (.fdb) database file directly. |
| <i>Client</i> | Enter the path to the fbclient.dll file. By default, this is the <code>bin</code> subdirectory of the Firebird installation directory. |
| <i>Database Account</i> | Enter the database user name supplied by the database administrator (in this example, <code>PROD_ADMIN</code>). |
| <i>Password</i> | Enter the database password supplied by the database administrator. |

6. Click **OK**.

17.1.10.3 IBM DB2 (JDBC)

This example illustrates how to connect to an **IBM DB2** database server through JDBC.

Prerequisites:

- JRE (Java Runtime Environment) or Java Development Kit (JDK) must be installed. This may be either Oracle JDK or an open source build such as Oracle OpenJDK. XMLSpy will determine the path to the Java Virtual Machine (JVM) from the following locations, in this order: a) The custom JVM path you may have set in application **Options**; b) The JVM path found in the Windows registry; c) The `JAVA_HOME` environment variable.
- Make sure that the platform of XMLSpy (32-bit, 64-bit) matches that of the JRE/JDK. This example uses Oracle's OpenJDK 11.0 64-bit, and, consequently, the 64-bit version of XMLSpy.
- The JDBC driver (one or several .jar files that provide connectivity to the database) must be available on your operating system. This example uses the JDBC driver available after installing the **IBM Data Server Client** version 10.1 (64-bit). For the JDBC drivers to be installed, choose a **Typical** installation, or select this option explicitly on the installation wizard.

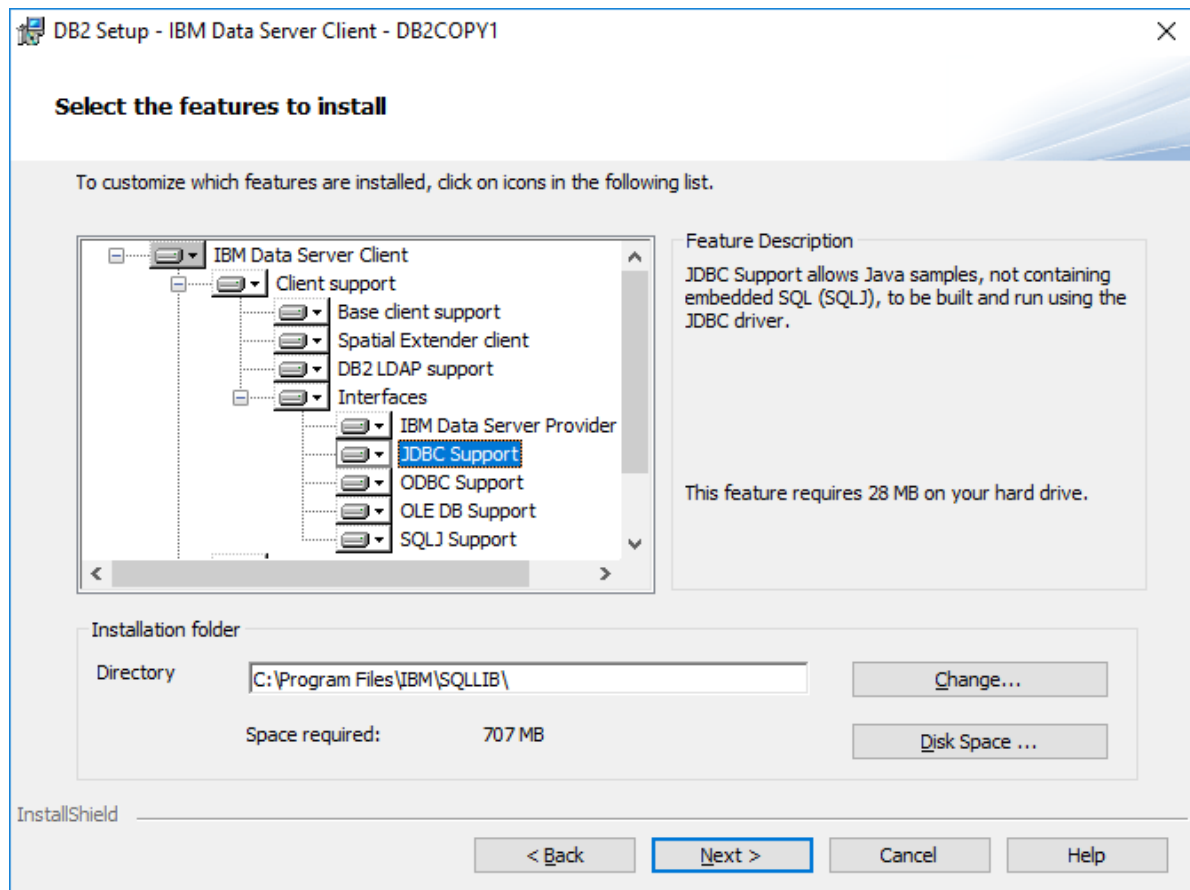

If you did not change the default installation path, the required .jar files will be in the **C:\Program Files\IBM\SQLLIB\java** directory after installation.

- You need the following database connection details: host, port, database name, username, and password.

To connect to IBM DB2 through JDBC:

1. [Start the database connection wizard](#) ⁶¹⁰.
2. Click **JDBC Connections**.
3. Next to "Classpaths", enter the path to the .jar file which provides connectivity to the database. This examples refers to **C:\Program Files\IBM\SQLLIB\java\db2jcc.jar**. You may need to refer to the **db2jcc4.jar** driver, depending on the database server version. For driver compatibility, refer to IBM documentation (<http://www-01.ibm.com/support/docview.wss?uid=swg21363866>). Note that you can leave the "Classpaths" text box empty if you have added the .jar file path(s) to the CLASSPATH environment variable of the operating system (see also [Configuring the CLASSPATH](#) ⁶³⁴).
4. In the "Driver" box, select **com.ibm.db2.jcc.DB2Driver**. This entry becomes available only if a valid .jar file path was found either in the "Classpaths" text box, or in the operating system's CLASSPATH environment variable (see the previous step).

| | |
|---------------|--|
| Classpaths: | <input type="text" value="C:\Program Files\IBM\SQLLIB\java\db2jcc.jar"/> |
| Driver: | <input type="text" value="com.ibm.db2.jcc.DB2Driver"/> |
| Username: | <input type="text" value="username"/> |
| Password: | <input type="password" value="●●●●●●●●"/> |
| Database URL: | <input type="text" value="jdbc:db2://dbserver:50000/dbname"/> |

5. Enter the username and password of the database user in the corresponding text boxes.
6. Enter the JDBC connection string in the **Database URL** text box. Make sure to replace the connection details with the ones applicable to your database server.

```
jdbc:db2://hostName:port/databaseName
```

7. Click **Connect**.

17.1.10.4 IBM DB2 (ODBC)

This example illustrates how to connect to an IBM DB2 database through ODBC.

Prerequisites:

- IBM Data Server Client must be installed and configured on your operating system (this example uses IBM Data Server Client 9.7). For installation instructions, check the documentation supplied with your IBM DB2 software. After installing the IBM Data Server Client, check if the ODBC drivers are available on your machine (see [Viewing the Available ODBC Drivers](#)⁶³⁰).
- Create a database alias. There are several ways to do this:
 - From IBM DB2 Configuration Assistant
 - From IBM DB2 Command Line Processor
 - From the ODBC data source wizard (for this case, the instructions are shown below)
- You have the following database connection details: host, database, port, username, and password.

To connect to IBM DB2:

1. [Start the database connection wizard](#)⁶¹⁰ and select **IBM DB2 (ODBC/JDBC)**.
2. Click **Next**.

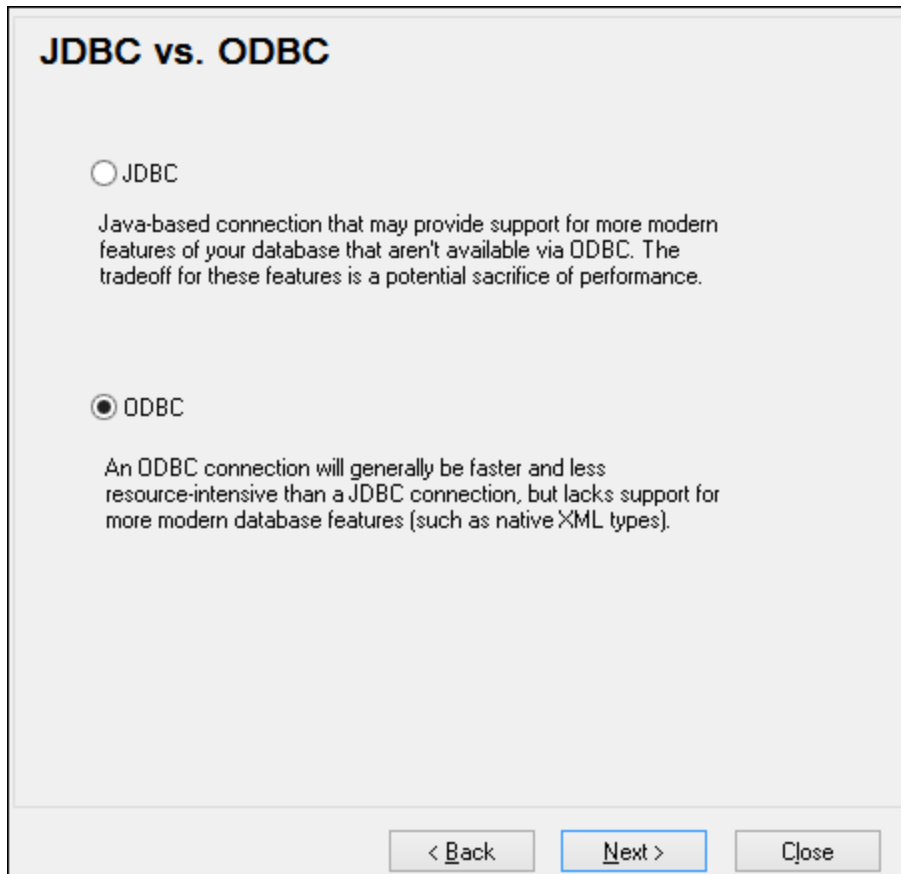

3. Select **ODBC**, and click **Next**. If prompted to edit the list of known drivers for the database, select the database drivers applicable to IBM DB2 (see [Prerequisites](#)⁶⁴⁷), and click **Next**.

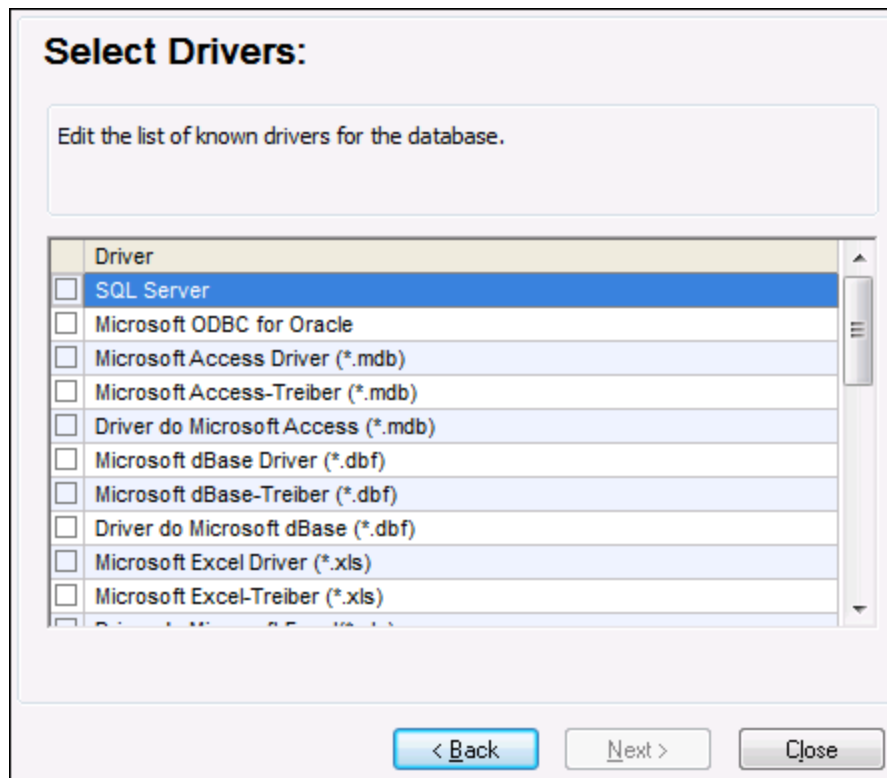

4. Select the IBM DB2 driver from the list, and then click **Connect**. (To edit the list of available drivers, click **Edit Drivers**, and then check or uncheck the IBM DB2 drivers you wish to add or remove, respectively.)

Connecting to IBM DB2

Where can I find IBM DB2 drivers?

Select an option how you wish to connect to the database and click Connect.

Create a new Data Source Name (DSN) with the driver:

IBM DB2 ODBC DRIVER

Use an existing Data Source Name:

User DSN System DSN Edit Drivers

Skip the configuration step for wizard

< Back Connect Close

5. Enter a data source name (in this example, **DB2DSN**), and then click **Add**.

Select the DB2 database alias you want to register for ODBC, or select Add to create a new alias. You may change the data source name and description, or accept the default.

Data source name: DB2DSN

Database alias: Add

Description:

OK Cancel

6. On the **Data Source** tab, enter the user name and password to the database.

The image shows a dialog box titled "Data Source" with four tabs: "Data Source", "TCP/IP", "Security options", and "Advanced Settings". The "TCP/IP" tab is selected. The dialog contains the following fields and controls:

- Data source name:** A text box containing "DB2DSN".
- Description:** An empty text box.
- User ID:** A text box containing "john_doe".
- Password:** A text box containing ten dots (••••••••••).
- Save password:** An unchecked checkbox.

At the bottom of the dialog, there are four buttons: "OK", "Cancel", "Apply", and "Help".

7. On the **TCP/IP** tab, enter the database name, a name for the alias, the host name and the port number, and then click OK.

Data Source TCP/IP Security options **Advanced Settings**

Database name

Database alias

Host name

Port number

The database physically resides on a host or QS/400 system.

Connect directly to the server

Connect to the server via the gateway

DCS Parameters

Optimize for application

OK Cancel Apply Help

8. Enter again the username and password, and then click **OK**.

Database alias

User ID

Password

Change password

New password

Verify new password

Connection mode

Share Exclusive

OK Cancel

17.1.10.5 IBM DB2 for i (JDBC)

This example illustrates how to connect to an **IBM DB2 for i** database server through JDBC.

Prerequisites:

- JRE (Java Runtime Environment) or Java Development Kit (JDK) must be installed. This may be either Oracle JDK or an open source build such as Oracle OpenJDK. XMLSpy will determine the path to the Java Virtual Machine (JVM) from the following locations, in this order: a) The custom JVM path you may have set in application **Options**; b) The JVM path found in the Windows registry; c) The `JAVA_HOME` environment variable.
- Make sure that the platform of XMLSpy (32-bit, 64-bit) matches that of the JRE/JDK. This example uses Oracle's OpenJDK 11.0 64-bit, and, consequently, the 64-bit version of XMLSpy.
- The JDBC driver (one or several .jar files that provide connectivity to the database) must be available on your operating system. This example uses the open source **Toolbox for Java/JTOpen** version 9.8 (<http://jt400.sourceforge.net/>). After you download the package and unpack to a local directory, the required .jar files will be available in the **lib** subdirectory.
- You need the following database connection details: host, username, and password.

To connect to IBM DB2 for i through JDBC:

1. [Start the database connection wizard](#) ⁶¹⁰.
2. Click **JDBC Connections**.
3. Next to "Classpaths", enter the path to the .jar file which provides connectivity to the database. In this example, the required .jar file is at the following path: **C:\jdbc\jtopen_9_8\lib\jt400.jar**. Note that you can leave the "Classpaths" text box empty if you have added the .jar file path(s) to the CLASSPATH environment variable of the operating system (see also [Configuring the CLASSPATH](#) ⁶³⁴).
4. In the "Driver" box, select **com.ibm.as400.access.AS400JDBCdriver**. This entry becomes available only if a valid .jar file path was found either in the "Classpaths" text box, or in the operating system's CLASSPATH environment variable (see the previous step).

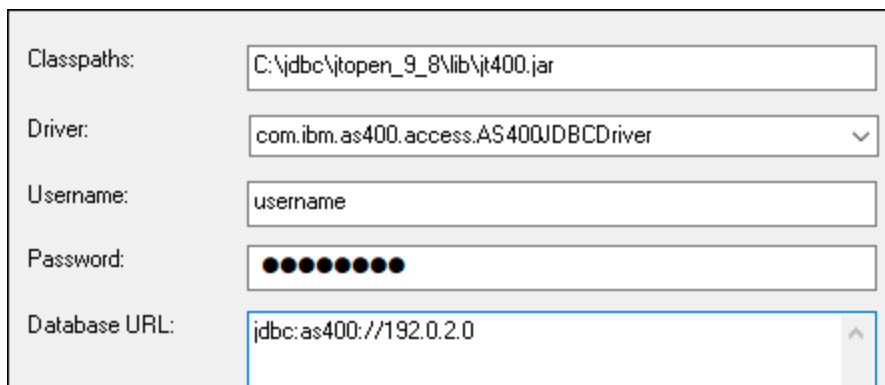

| | |
|---------------|--------------------------------------|
| Classpaths: | C:\jdbc\jtopen_9_8\lib\jt400.jar |
| Driver: | com.ibm.as400.access.AS400JDBCdriver |
| Username: | username |
| Password: | ●●●●●●●● |
| Database URL: | jdbc:as400://192.0.2.0 |

5. Enter the username and password of the database user in the corresponding text boxes.
6. Enter the JDBC connection string in the **Database URL** text box. Make sure to replace **host** with the host name or IP address of your database server.

```
jdbc:as400://host
```

- Click **Connect**.

17.1.10.6 IBM DB2 for i (ODBC)

This example illustrates how to connect to an *IBM DB2 for i* database through ODBC.

Prerequisites:

- IBM System i Access for Windows* must be installed on your operating system (this example uses *IBM System i Access for Windows V6R1M0*). For installation instructions, check the documentation supplied with your *IBM DB2 for i* software. After installation, check if the ODBC driver is available on your machine (see [Viewing the Available ODBC Drivers](#)⁶³⁰).

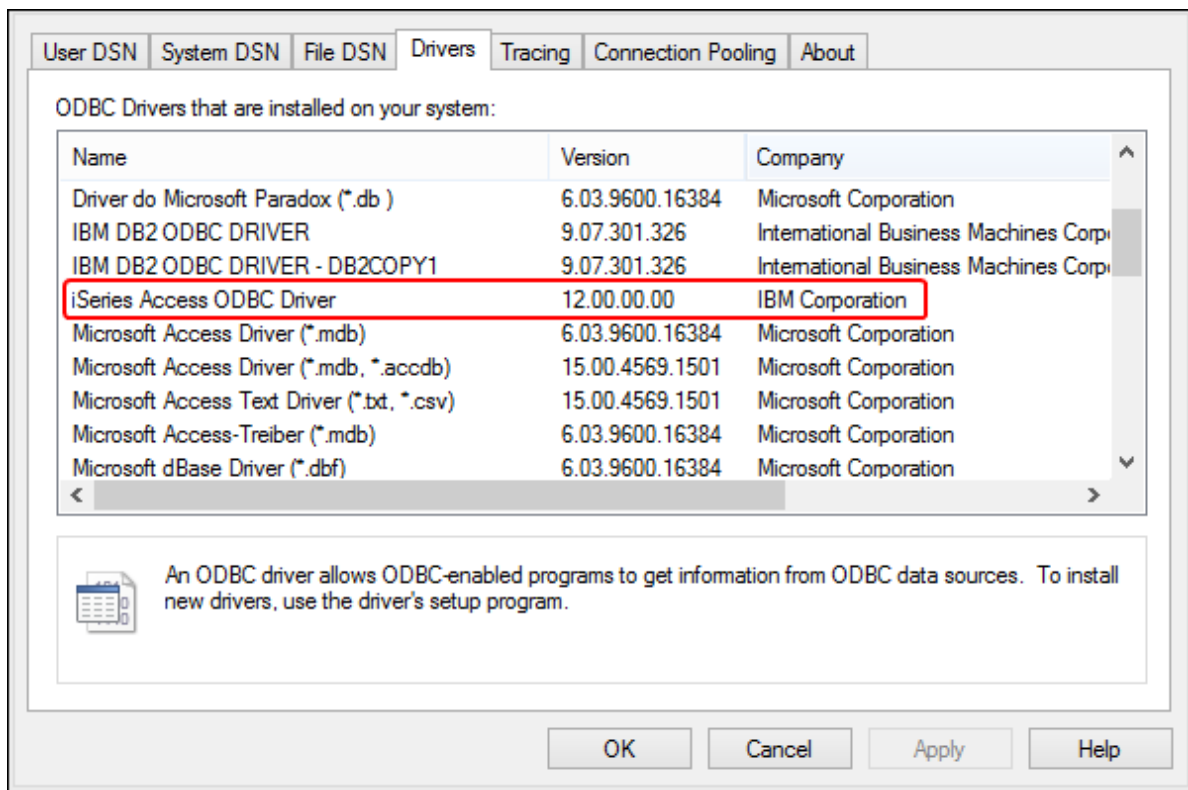

- You have the following database connection details: the I.P. address of the database server, database user name, and password.
- Run *System i Navigator* and follow the wizard to create a new connection. When prompted to specify a system, enter the I.P. address of the database server. After creating the connection, it is recommended to verify it (click on the connection, and select **File > Diagnostics > Verify Connection**). If you get connectivity errors, contact the database server administrator.

To connect to IBM DB2 for i:

- [Start the database connection wizard](#)⁶¹⁰.
- Click **ODBC connections**.

3. Click **User DSN** (alternatively, click **System DSN**, or **File DSN**, in which case the subsequent instructions will be similar).
4. Click **Add** .
5. Select the **iSeries Access ODBC Driver** from the list, and click **User DSN** (or **System DSN**, if applicable).

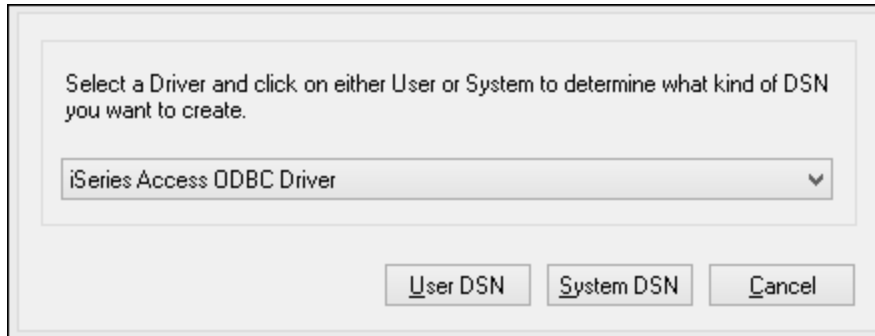

6. Enter a data source name and select the connection from the System combo box. In this example, the data source name is **iSeriesDSN** and the System is **192.0.2.0**.

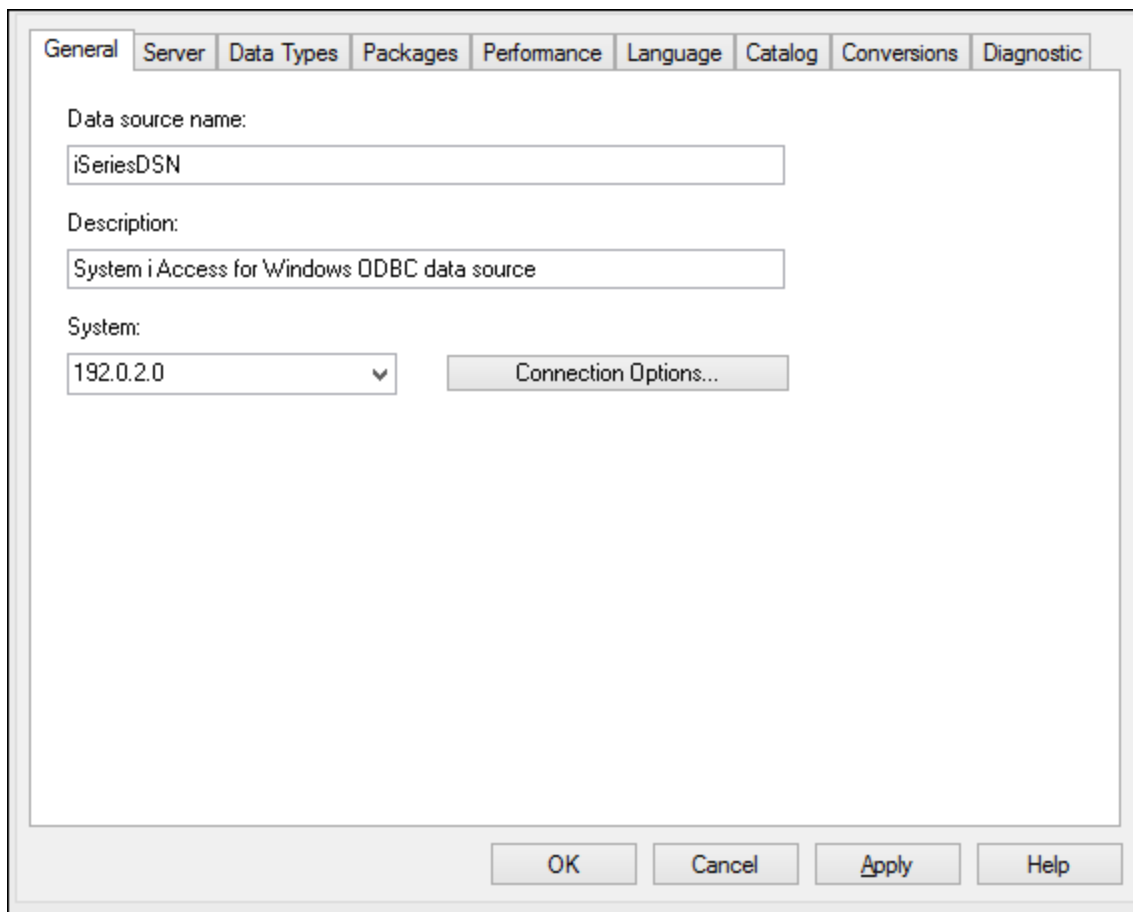

7. Click **Connection Options**, select **Use the User ID specified below** and enter the name of the database user (in this example, **DBUSER**).

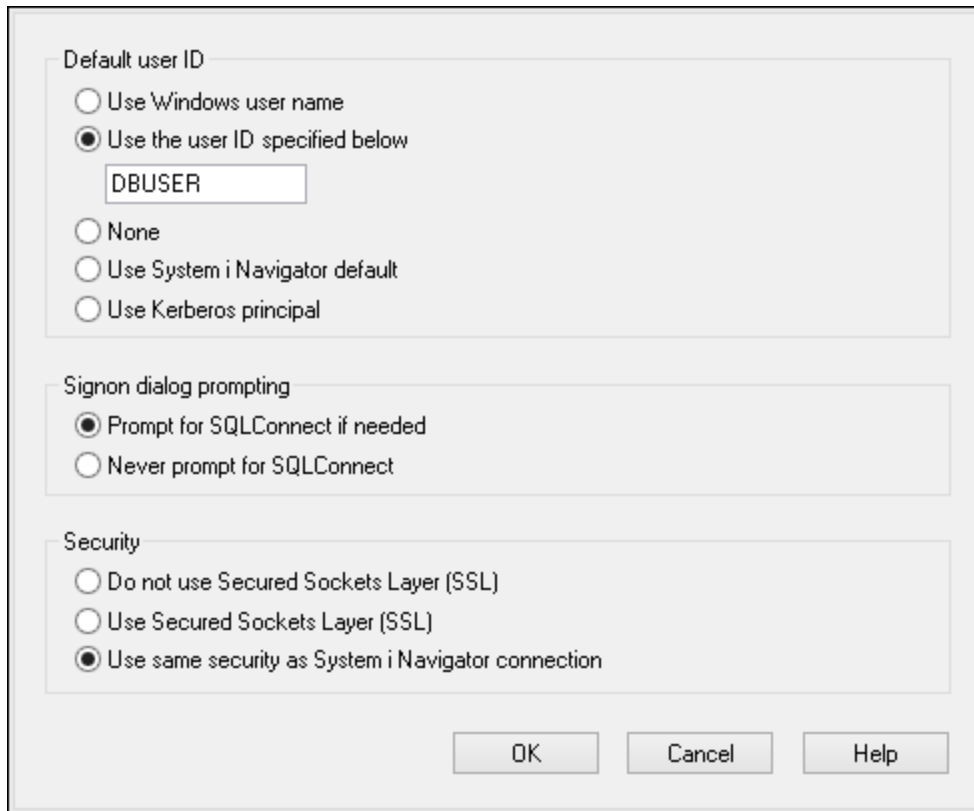

8. Click **OK**. The new data source becomes available in the list of DSNs.
9. Click **Connect**.
10. Enter the user name and password to the database when prompted, and then click **OK**.

17.1.10.7 IBM Informix (JDBC)

This example illustrates how to connect to an IBM Informix database server through JDBC.

Prerequisites:

- JRE (Java Runtime Environment) or Java Development Kit (JDK) must be installed. This may be either Oracle JDK or an open source build such as Oracle OpenJDK. XMLSpy will determine the path to the Java Virtual Machine (JVM) from the following locations, in this order: a) The custom JVM path you may have set in application **Options**; b) The JVM path found in the Windows registry; c) The `JAVA_HOME` environment variable.
- Make sure that the platform of XMLSpy (32-bit, 64-bit) matches that of the JRE/JDK.
- The JDBC driver (one or several .jar files that provide connectivity to the database) must be available on your operating system. In this example, IBM Informix JDBC driver version 3.70 is used. For the driver's installation instructions, see the documentation accompanying the driver or the "IBM Informix JDBC Driver Programmer's Guide".
- You have the following database connection details: host, name of the Informix server, database, port, username, and password.

To connect to IBM Informix through JDBC:

1. [Start the database connection wizard](#) ⁶¹⁰.
2. Click **JDBC Connections**.
3. Next to "Classpaths", enter the path to the .jar file which provides connectivity to the database. If necessary, you can also enter a semicolon-separated list of .jar file paths. In this example, the required .jar file is located at the following path: **C:\Informix_JDBC_Driver\lib\ifxjdbc.jar**. Note that you can leave the "Classpaths" text box empty if you have added the .jar file path(s) to the CLASSPATH environment variable of the operating system (see also [Configuring the CLASSPATH](#) ⁶³⁴).
4. In the "Driver" box, select **com.informix.jdbc.IfxDriver**. Note that this entry is available if a valid .jar file path is found either in the "Classpaths" text box, or in the operating system's CLASSPATH environment variable (see the previous step).

Classpaths: C:\jdbc\Informix_JDBC_Driver\lib\ifxjdbc.jar;

Driver: com.informix.jdbc.IfxDriver

Username: dbuser

Password: ●●●●●●

Database URL: jdbc:informix-sqli://host:port/MyDatabase:INFORMIXSERVER=MyServerName

Connect Close

5. Enter the username and password to the database in the corresponding text boxes.
6. Enter the connection string to the database server in the Database URL text box, by replacing the highlighted values with the ones applicable to your database server.

```
jdbc:informix-sqli://hostName:port/databaseName:INFORMIXSERVER=myserver;
```

7. Click **Connect**.

17.1.10.8 MariaDB (ODBC)

This example illustrates how to connect to a MariaDB database server through ODBC.

Prerequisites:

- The MariaDB Connector/ODBC (<https://downloads.mariadb.org/connector-odbc/>) must be installed.
- You have the following database connection details: host, database, port, username, and password.

To connect to MariaDB through ODBC:

1. [Start the database connection wizard](#)⁶¹⁰.
2. Select **MariaDB (ODBC)**, and then click **Next**.

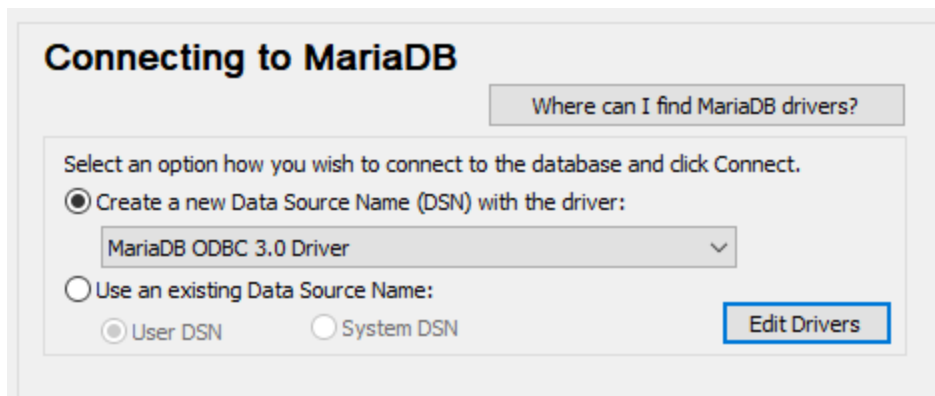

3. Select **Create a new Data Source Name (DSN) with the driver**, and choose **MariaDB ODBC 3.0 Driver**. If no such driver is available in the list, click **Edit Drivers**, and select any available MariaDB drivers (the list contains all ODBC drivers installed on your operating system).
4. Click **Connect**.

Create a new Data Source to MariaDB

Welcome to the MariaDB ODBC Data Source Wizard!

This wizard will help you to create an ODBC data source that you can use to connect to a MariaDB server.

What name do you want to use to refer to your data source ?

Name:

How do you want to describe the data source ?

Description:

< Previous Next > Cancel Help

5. Enter name and, optionally, a description that will help you identify this ODBC data source in future.

Create a new Data Source to MariaDB

How do you want to connect to MariaDB

TCP/IP Server Name:

Named Pipe Port:

Please specify a user name and password to connect to MariaDB

User name:

Password:

Please specify a user name and password to connect to MariaDB

Database: ▾

< Previous Next > Cancel Help

6. Fill in the database connection credentials (TCP/IP Server, User, Password), select a database, and then click **Test DSN**. Upon successful connection, a message box appears:

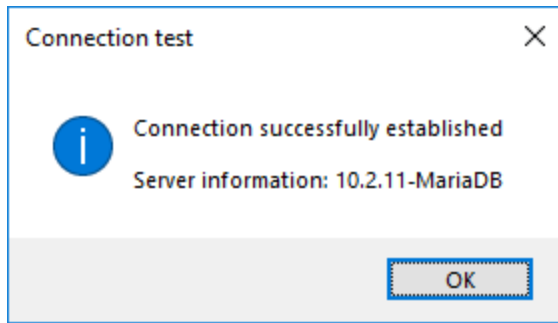

7. Click **Next** and complete the wizard. Other parameters may be required, depending on the case (for example, SSL certificates if you are connecting to MariaDB through a secure connection).

Note: If the database server is remote, it must be configured by the server administrator to accept remote connections from your machine's IP address.

17.1.10.9 Microsoft Access (ADO)

A simple way to connect to a Microsoft Access database is to follow the wizard and browse for the database file, as shown in [Connecting to an Existing Microsoft Access Database](#)⁶¹⁸. An alternative approach is to set up an ADO connection explicitly, as shown in this topic. This approach is useful if your database is password-protected.

It is also possible to connect to Microsoft Access through an ODBC connection, but it has limitations, so it is best to avoid it.

To connect to a password-protected Microsoft Access database:

1. [Start the database connection wizard](#)⁶¹⁰.
2. Click **ADO Connections**.
3. Click **Build**.

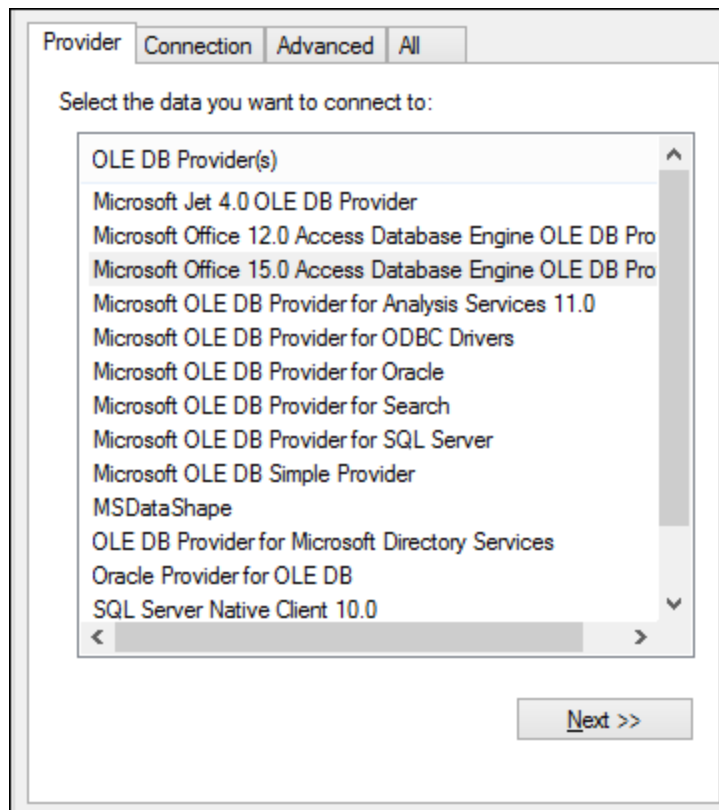

4. Select the **Microsoft Office 15.0 Access Database Engine OLE DB Provider**, and then click **Next**.

5. In the Data Source box, enter the path to the Microsoft Access file in UNC format, for example, \\myserver\mynetworkshare\Reports\Revenue.accdb, where **myserver** is the name of the server and **mynetworkshare** is the name of the network share.
6. On the **All** tab, double click the **Jet OLEDB:Database Password** property and enter the database password as property value.

Note: If you are still unable to connect, locate the workgroup information file (**System.MDW**) applicable to your user profile, and set the value of the **Jet OLEDB: System database** property to the path of the **System.MDW** file.

17.1.10.10 Microsoft Azure SQL (ODBC)

In order to connect properly to an Azure SQL database, you must install the latest [SQL Server Native Client](#).

For information about connecting to an Azure SQL database in the cloud, see this [Altova blog entry](#).

17.1.10.11 Microsoft SQL Server (ADO)

This example illustrates how to connect to a SQL Server database through ADO. These instructions are applicable when you use the recommended **Microsoft OLE DB Driver for SQL Server (MSOLEDBSQL)**, which is available for download at <https://docs.microsoft.com/en-us/sql/connect/oledb/download-oledb-driver-for-sql-server?view=sql-server-ver15>.

Before following these instructions, make sure that you have downloaded and installed the provider above on your workstation. The ADO provider must match the platform of XMLSpy (32-bit or 64-bit).

If you would like to use other ADO providers such as **SQL Server Native Client (SQLNCLI)** or **Microsoft OLE DB Provider for SQL Server (SQLOLEDB)**, the instructions are similar, but these providers are deprecated and thus not recommended. Also, for the connection to be successful with a deprecated provider, you may need to set additional connection properties as described in [Setting up the SQL Server Data Link Properties](#) ⁶¹⁹.

The **Microsoft OLE DB Provider for SQL Server (SQLOLEDB)** is known to have issues with parameter binding of complex queries like Common Table Expressions (CTE) and nested SELECT statements.

To connect to SQL Server:

1. [Start the database connection wizard](#) ⁶¹⁰.
2. Select **Microsoft SQL Server (ADO)**, and then click **Next**. The list of available ADO providers is displayed. In this example, the **Microsoft OLE DB Driver for SQL Server** is used. If it's not in the list, make sure that it is installed on your computer, as mentioned above.

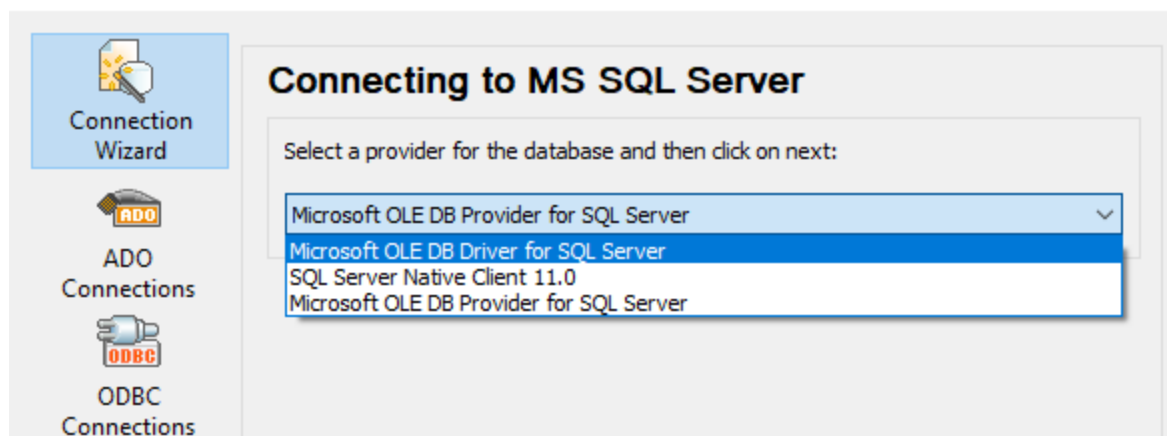

3. Click **Next**. The Data Link Properties dialog box appears.

4. Select or enter the name of the database server, for example, **SQLSERV01**. If you are connecting to a named SQL Server instance, the server name looks like **SQLSERV01\SOMEINSTANCE**.
5. If the database server was configured to allow connections from users authenticated on the Windows domain, select **Windows Authentication**. Otherwise, select **SQL Server Authentication**, clear the **Blank password** check box, and enter the database credentials in the relevant boxes.
6. Select the **Allow saving password** check box and the database to which you are connecting (in this example, "Nanonull").

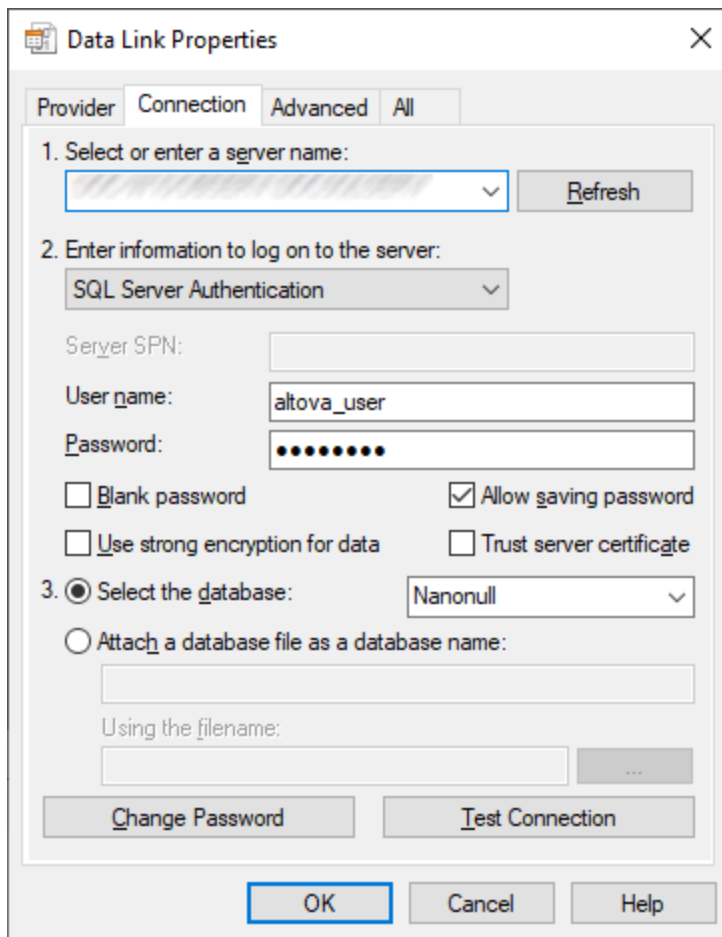

7. To test the connection at this time, click **Test Connection**. This is an optional, recommended step.
8. Click **OK**.

17.1.10.12 Microsoft SQL Server (ODBC)

This example illustrates how to connect to a SQL Server database through ODBC.

Prerequisites:

- Download and install the **Microsoft ODBC Driver for SQL Server** from the Microsoft website, see <https://docs.microsoft.com/en-us/SQL/connect/odbc/download-odbc-driver-for-sql-server>. This example uses **Microsoft ODBC Driver 17 for SQL Server** to connect to a **SQL Server 2016** database. You might want to download a different ODBC driver version, depending on the version of SQL Server where you want to connect. For information about ODBC driver versions supported by your SQL Server database, refer to the driver's system requirements.

To connect to SQL Server using ODBC:

1. [Start the database connection wizard](#) ⁶¹⁰.
2. Click **ODBC Connections**.
3. Select **User DSN** (or **System DSN**, if you have administrative privileges), and then click **Add** .
4. Select the driver from the list. Note that the driver appears in the list only after it has been installed.

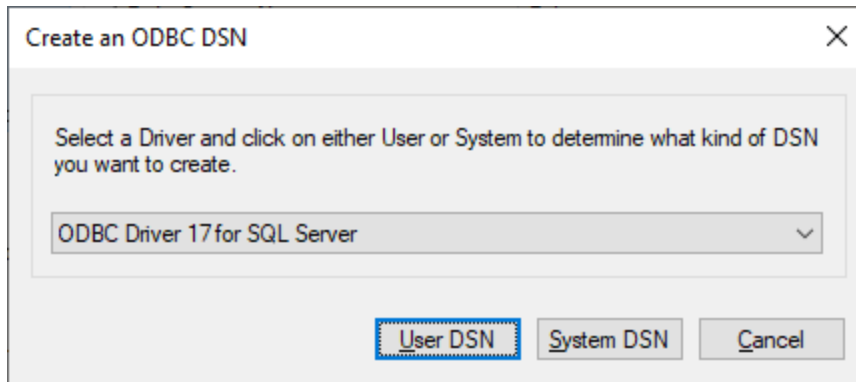

5. Click **User DSN** (or **System DSN** if you are creating a System DSN).

Creating a **System DSN** requires that XMLSpy be run as an administrator. Therefore, in order to create a **System DSN**, cancel the wizard, make sure that you run XMLSpy as an administrator, and perform the steps above again.

6. Enter a name and, optionally, a description to identify this connection, and then select from the list the SQL Server to which you are connecting (**SQLSERV01** in this example).

Microsoft SQL Server DSN Configuration

This wizard will help you create an ODBC data source that you can use to connect to SQL Server.

What name do you want to use to refer to the data source?

Name:

How do you want to describe the data source?

Description:

Which SQL Server do you want to connect to?

Server:

Finish Next > Cancel Help

7. If the database server was configured to allow connections from users authenticated on the Windows domain, select **With Integrated Windows authentication**. Otherwise, select one of the other options, as applicable. This example uses **With SQL Server authentication...**, which requires that the user name and password be entered in the relevant boxes.

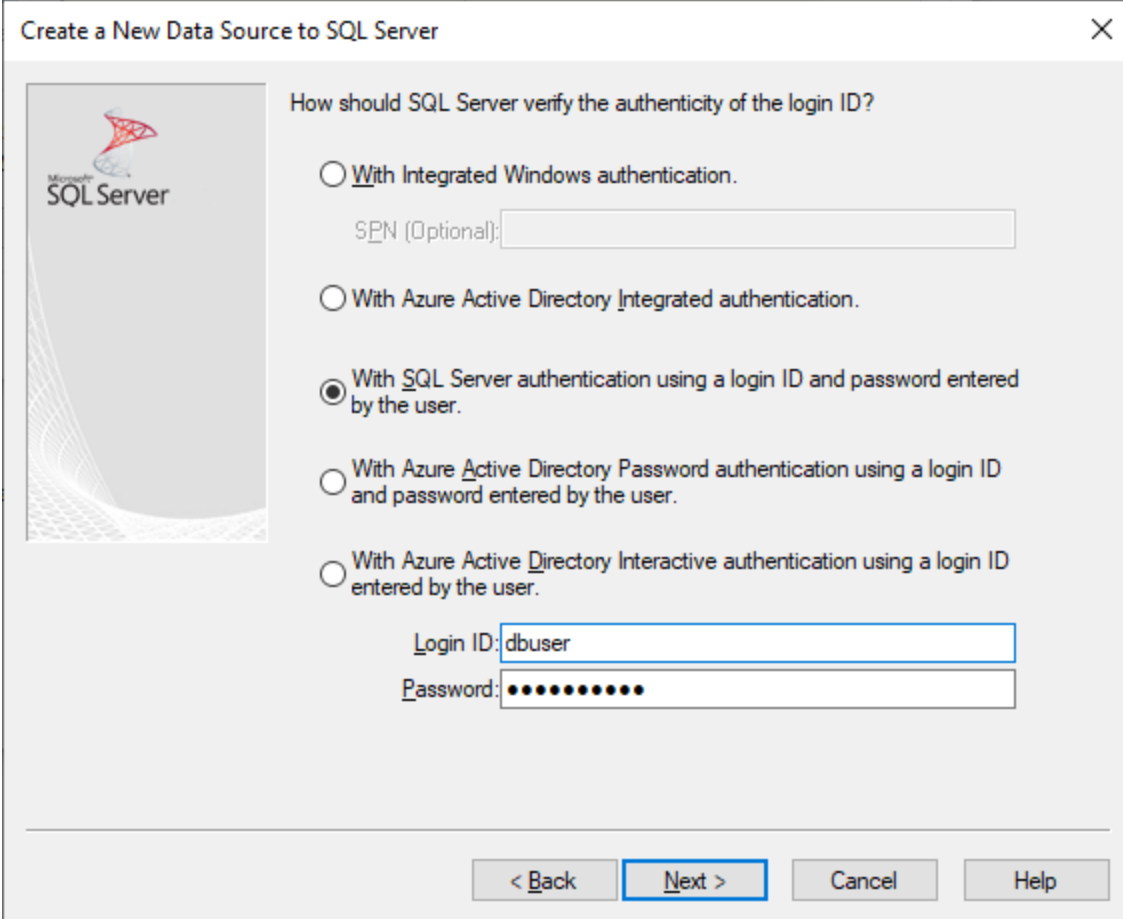

Microsoft SQL Server

How should SQL Server verify the authenticity of the login ID?

With Integrated Windows authentication.
SPN (Optional):

With Azure Active Directory Integrated authentication.

With SQL Server authentication using a login ID and password entered by the user.

With Azure Active Directory Password authentication using a login ID and password entered by the user.

With Azure Active Directory Interactive authentication using a login ID entered by the user.

Login ID:

Password:

< Back Next > Cancel Help

8. Optionally, select the **Change the default database to** check box and enter the name of the database to which you are connecting (in this example, **Sandbox**).

Create a New Data Source to SQL Server

Change the default database to:
Sandbox

Mirror server:
[Empty text box]

SPN for mirror server (Optional):
[Empty text box]

Attach database filename:
[Empty text box]

Use ANSI quoted identifiers.

Use ANSI nulls, paddings and warnings.

Application intent:
READWRITE

Multi-subnet failover.

Transparent Network IP Resolution.

Column Encryption.

Enclave Attestation Info: [Empty text box]

Use FMTONLY metadata discovery.

< Back Next > Cancel Help

9. Click **Next** and, optionally, configure additional parameters for this connection.

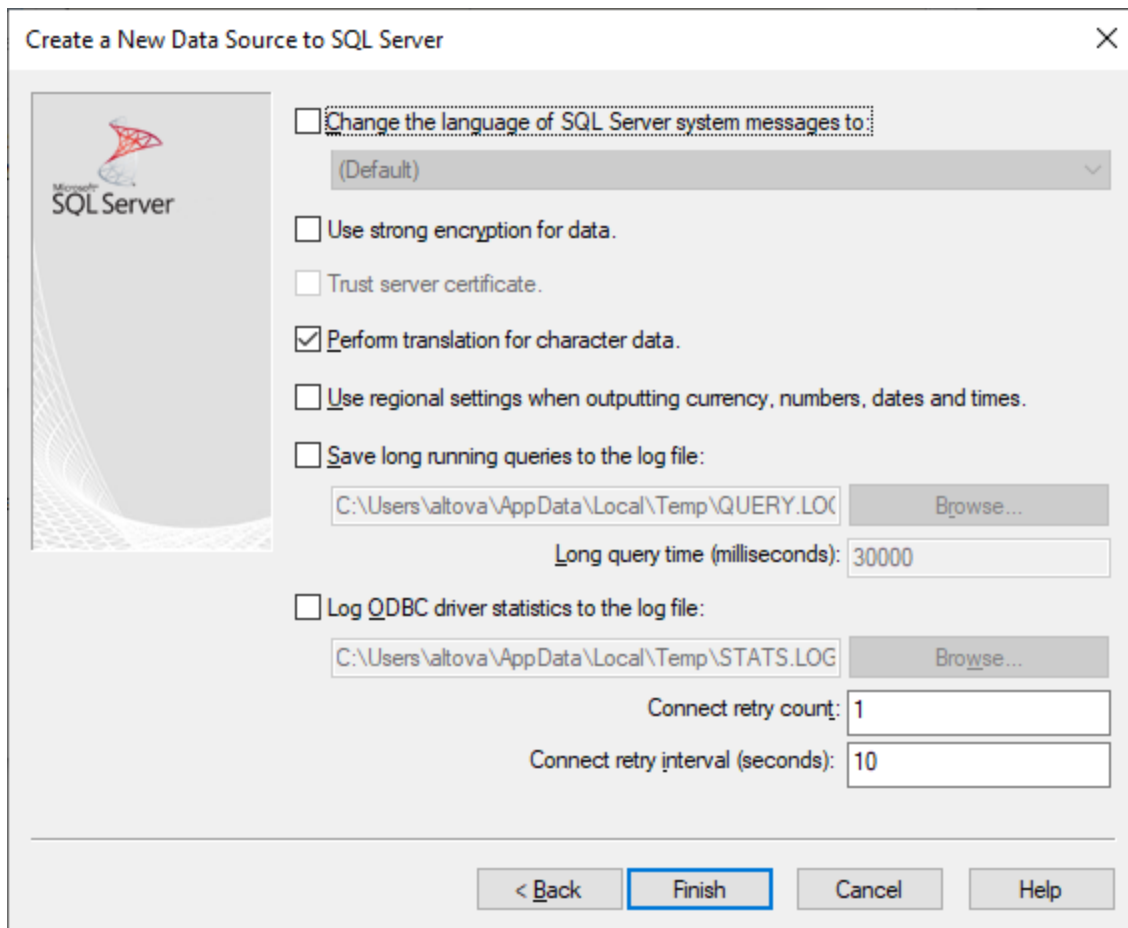

10. Click **Finish**. A confirmation dialog box listing the connection details opens.

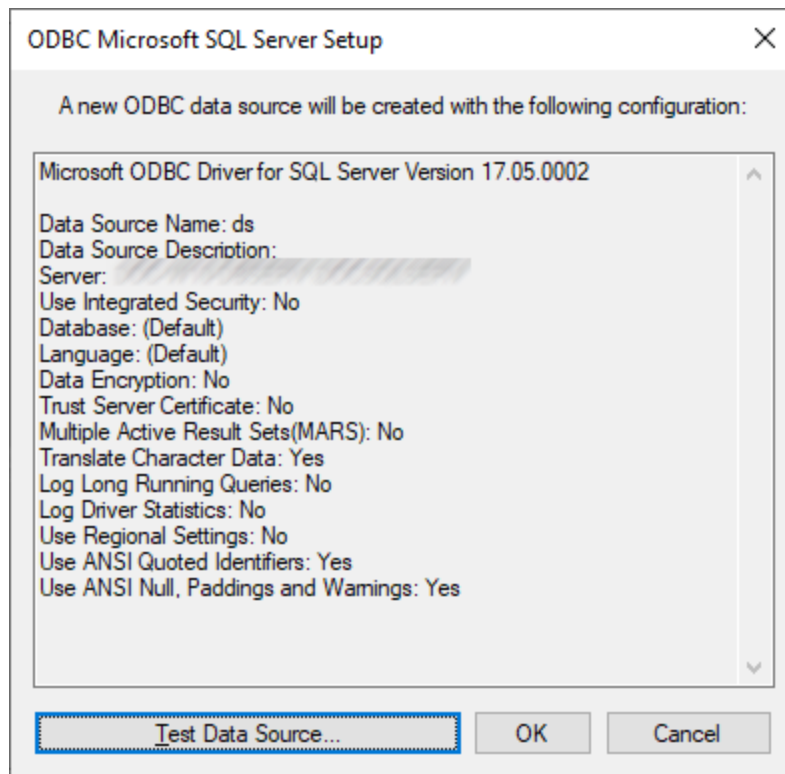

11. Click **OK**. The data source now appears in the list of **User** or **System** data sources, as configured, for example:

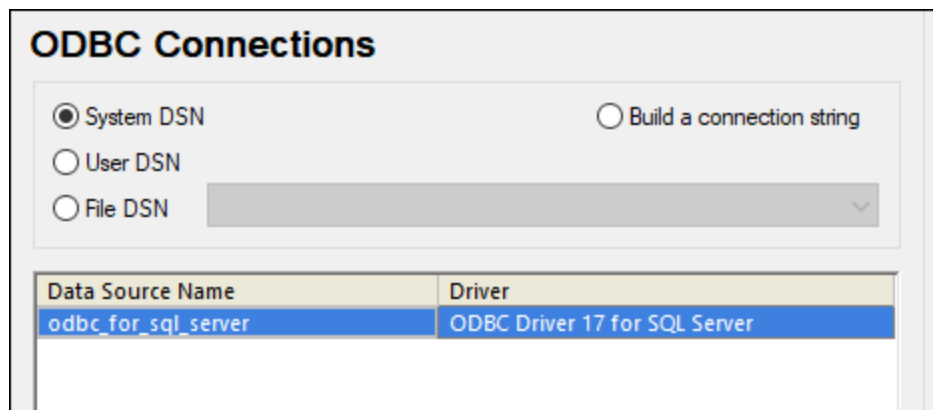

17.1.10.13 MySQL (ODBC)

This example illustrates how to connect to a MySQL database server from a Windows machine through the ODBC driver. The MySQL ODBC driver is not available on Windows, so it must be downloaded and installed separately. This example uses MySQL Connector/ODBC 8.0.

Prerequisites:

- MySQL ODBC driver must be installed on your operating system. Check the MySQL documentation for the driver version recommended for your database server version (see <https://dev.mysql.com/downloads/connector/odbc/>).
- You have the following database connection details: host, database, port, username, and password.

If you installed MySQL Connector/ODBC for 64-bit platform, make sure to install XMLSpy for 64-bit platform as well.

To connect to MySQL via ODBC:

1. [Start the database connection wizard](#) ⁶¹⁰.
2. Select **MySQL (ODBC)**, and then click **Next**.

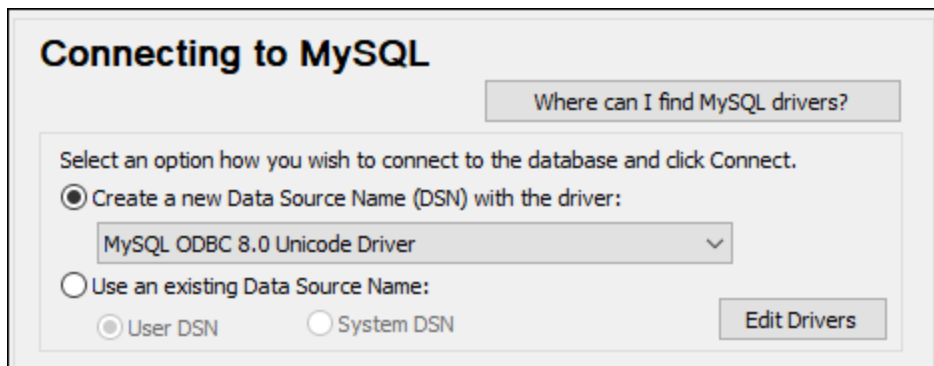

3. Select **Create a new Data Source Name (DSN) with the driver**, and select a MySQL driver. If no MySQL driver is available in the list, click **Edit Drivers**, and select any available MySQL drivers (the list contains all ODBC drivers installed on your operating system).

If you installed XMLSpy 64-bit, then the 64-bit ODBC drivers are shown in the list. Otherwise, the 32-bit ODBC drivers are shown. See also [Viewing the Available ODBC Drivers](#) ⁶³⁰.

4. Click **Connect**.

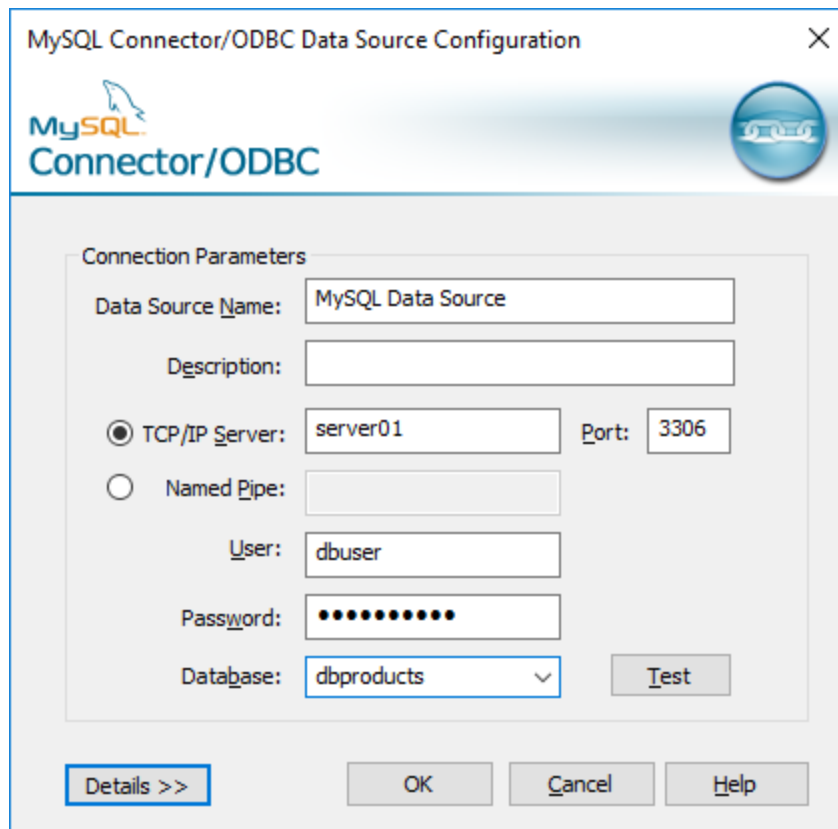

5. In the Data Source Name box, enter a descriptive name that will help you identify this ODBC data source in future.
6. Fill in the database connection credentials (TCP/IP Server, User, Password), select a database, and then click **OK**.

Note: If the database server is remote, it must be configured by the server administrator to accept remote connections from your machine's IP address. Also, if you click **Details>>**, there are several additional parameters available for configuration. Check the driver's documentation before changing their default values.

17.1.10.14 Oracle (JDBC)

This example shows you how to connect to an Oracle database server from a client machine, using the JDBC interface. The connection is created as a pure Java connection, using the **Oracle Instant Client Package (Basic)** available from the Oracle website. The advantage of this connection type is that it requires only the Java environment and the .jar libraries supplied by the Oracle Instant Client Package, saving you the effort to install and configure a more complex database client.

Prerequisites:

- JRE (Java Runtime Environment) or Java Development Kit (JDK) must be installed. This may be either Oracle JDK or an open source build such as Oracle OpenJDK. XMLSpy will determine the path to the Java Virtual Machine (JVM) from the following locations, in this order: a) The custom JVM path you

may have set in application **Options**; b) The JVM path found in the Windows registry; c) The `JAVA_HOME` environment variable.

- Make sure that the platform of XMLSpy (32-bit, 64-bit) matches that of the JRE/JDK.
- The **Oracle Instant Client Package (Basic)** must be available on your operating system. The package can be downloaded from the official Oracle website. This example uses Oracle Instant Client Package version 12.1.0.2.0, for Windows 32-bit and, consequently, Oracle JDK 32-bit.
- You have the following database connection details: host, port, service name, username, and password.

To connect to Oracle through the Instant Client Package:

1. [Start the database connection wizard](#) ⁶¹⁰.
2. Click **JDBC Connections**.
3. Next to "Classpaths", enter the path to the .jar file which provides connectivity to the database. If necessary, you can also enter a semicolon-separated list of .jar file paths. In this example, the required .jar file is located at the following path: `C:\jdbc\instantclient_12_1\ojdbc7.jar`. Note that you can leave the "Classpaths" text box empty if you have added the .jar file path(s) to the CLASSPATH environment variable of the operating system (see also [Configuring the CLASSPATH](#) ⁶³⁴).
4. In the "Driver" box, select either `oracle.jdbc.OracleDriver` or `oracle.jdbc.driver.OracleDriver`. Note that these entries are available if a valid .jar file path is found either in the "Classpaths" text box, or in the operating system's CLASSPATH environment variable (see the previous step).
5. Enter the username and password to the database in the corresponding text boxes.

The screenshot shows a dialog box for configuring a database connection. It has five main input areas: 'Classpaths' (text box with path), 'Driver' (dropdown menu), 'Username' (text box), 'Password' (masked text box), and 'Database URL' (text area with a highlighted connection string). At the bottom, there are 'Connect' and 'Close' buttons.

6. Enter the connection string to the database server in the Database URL text box, by replacing the highlighted values with the ones applicable to your database server.

```
jdbc:oracle:thin:@//host:port:service
```

7. Click **Connect**.

17.1.10.15 Oracle (ODBC)

This example illustrates a common scenario where you connect from XMLSpy to an Oracle database server on a network machine, through an Oracle database client installed on the local operating system.

The example includes instructions for setting up an ODBC data source (DSN) using the database connection wizard in XMLSpy. If you have already created a DSN, or if you prefer to create it directly from the **ODBC Data Source administrator** in Windows, you can do so, and then select it when prompted by the wizard. For more information about ODBC data sources, see [Setting up an ODBC Connection](#)⁶²⁸.

Prerequisites:

- The Oracle database client (which includes the ODBC Oracle driver) must be installed and configured on your operating system. For instructions on how to install and configure an Oracle database client, refer to the documentation supplied with your Oracle software.
- The **tnsnames.ora** file located in Oracle home directory contains an entry that describes the database connection parameters, in a format similar to this:

```
ORCL =
  (DESCRIPTION =
    (ADDRESS_LIST =
      (ADDRESS = (PROTOCOL = TCP) (HOST = server01) (PORT = 1521))
    )
    (CONNECT_DATA =
      (SID = orcl)
      (SERVER = DEDICATED)
    )
  )
```

The path to the **tnsnames.ora** file depends on the location where Oracle home directory was installed. For Oracle database client 11.2.0, the default Oracle home directory path could be as follows:

```
C:\app\username\product\11.2.0\client_1\network\admin\tnsnames.ora
```

You can add new entries to the **tnsnames.ora** file either by pasting the connection details and saving the file, or by running the Oracle *Net Configuration Assistant* wizard (if available). If you want these values to appear in dropdown lists during the configuration process, then you may need to add the path to the admin folder as a **TNS_ADMIN** environment variable.

To connect to Oracle using ODBC:

1. [Start the database connection wizard](#)⁶¹⁰.
2. Select **Oracle (ODBC / JDBC)**, and then click **Next**.

JDBC vs. ODBC

JDBC

Java-based connection that may provide support for more modern features of your database that aren't available via ODBC. The tradeoff for these features is a potential sacrifice of performance.

ODBC

An ODBC connection will generally be faster and less resource-intensive than a JDBC connection, but lacks support for more modern database features (such as native XML types).

< Back Next > Close

3. Select **ODBC**.

Connecting to Oracle

Where can I find Oracle drivers?

Select an option how you wish to connect to the database and click Connect.

Create a new Data Source Name (DSN) with the driver:

Microsoft ODBC for Oracle

Use an existing Data Source Name:

User DSN System DSN Edit Drivers

Data Source Name

Skip the configuration step for wizard

< Back Connect Close

4. Click **Edit Drivers**.

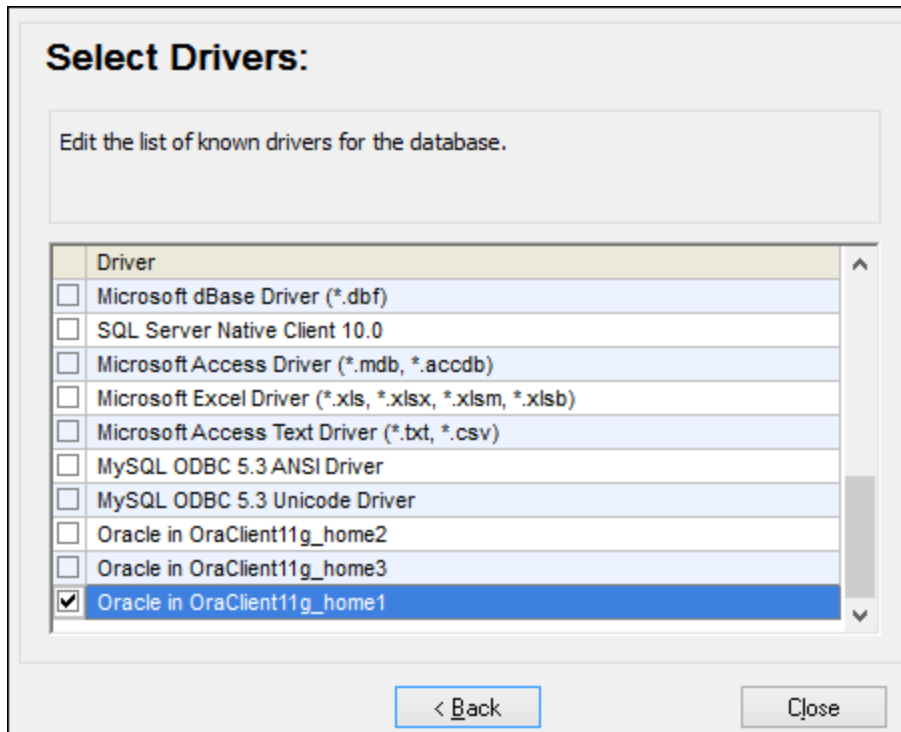

5. Select the Oracle drivers you wish to use (in this example, **Oracle in OraClient11g_home1**). The list displays the Oracle drivers available on your system after installation of Oracle client.
6. Click **Back**.
7. Select **Create a new data source name (DSN) with the driver**, and then select the Oracle driver chosen in step 4.

The screenshot shows a dialog box titled "Connecting to Oracle". At the top right, there is a button labeled "Where can I find Oracle drivers?". Below this, a text box says "Select an option how you wish to connect to the database and click Connect." There are two main radio button options: "Create a new Data Source Name (DSN) with the driver:" (which is selected) and "Use an existing Data Source Name:". Under the "Create a new DSN" option, there is a dropdown menu showing "Oracle in OraClient11g_home1". Under the "Use an existing DSN" option, there are two sub-radio buttons: "User DSN" and "System DSN" (which is selected). To the right of these sub-radio buttons is an "Edit Drivers" button. At the bottom left, there is a checkbox labeled "Skip the configuration step for wizard". At the bottom right, there are three buttons: "< Back", "Connect", and "Close".

Avoid using the Microsoft-supplied driver called **Microsoft ODBC for Oracle** driver. Microsoft recommends using the ODBC driver provided by Oracle (see <http://msdn.microsoft.com/en-us/library/ms714756%28v=vs.85%29.aspx>)

8. Click **Connect**.

9. In the Data Source Name text box, enter a name to identify the data source (in this example, **Oracle DSN 1**).
10. In the TNS Service Name box, enter the connection name as it is defined in the **tnsnames.ora** file (see [prerequisites](#)⁶⁷⁵). In this example, the connection name is **ORCL**. *Note:* If you wish to have the dropdown list of the combo box populated with the values of the **tnsnames.ora** file, then you may need to add the path to the admin folder as a **TNS_ADMIN** environment variable.
11. Click **OK**.

12. Enter the username and password to the database, and then click OK.

17.1.10.16 PostgreSQL (ODBC)

This example illustrates how to connect to a PostgreSQL database server from a Windows machine through the ODBC driver. The PostgreSQL ODBC driver is not available on Windows, so it must be downloaded and

installed separately. This example uses the psqLODBC driver (version 11.0) downloaded from the official website (see also [Database Drivers Overview](#)⁶¹²).

Note: You can also connect to a PostgreSQL database server directly (without the ODBC driver), see [Setting up a PostgreSQL Connection](#)⁶³⁸.

Prerequisites:

- *psqLODBC* driver must be installed on your operating system.
- You have the following database connection details: server, port, database, user name, and password.

To set up a connection to PostgreSQL using ODBC:

1. [Start the database connection wizard](#)⁶¹⁰.
2. Click **ODBC Connections**.
3. Select the **User DSN** option.
4. Click **Create a new DSN**  and select the driver from the drop-down list. If no PostgreSQL driver is available in the list, make sure that the PostgreSQL ODBC driver is installed on your operating system, as mentioned in the prerequisites above.

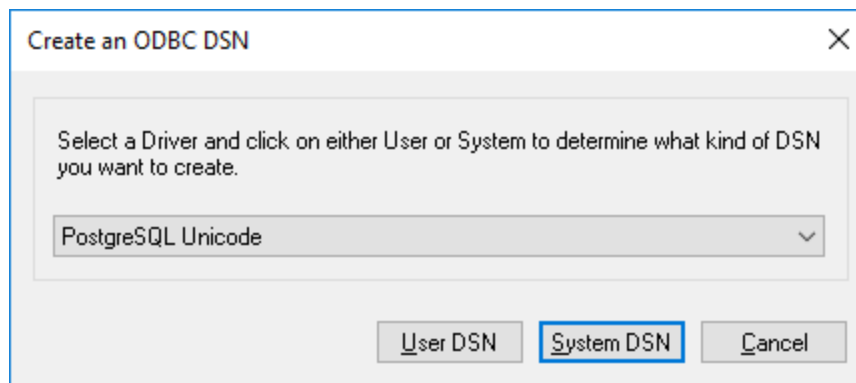

5. Click **User DSN**.

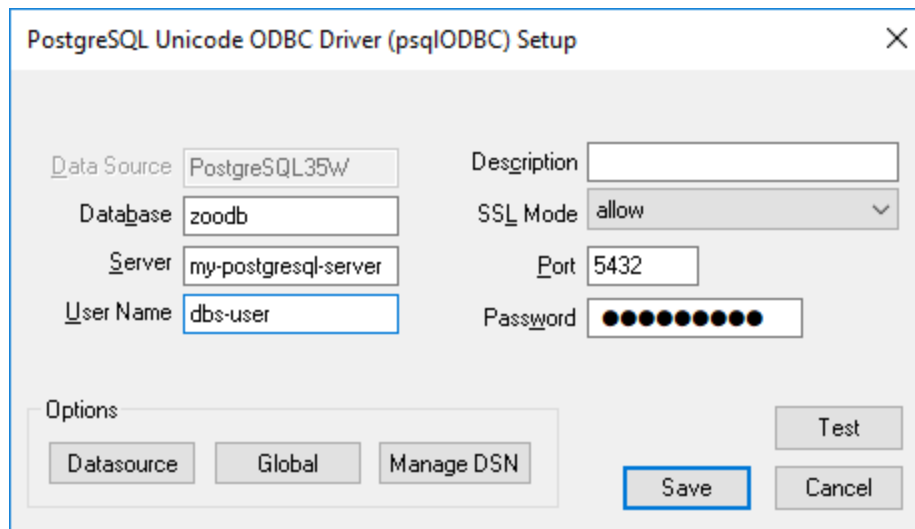

The screenshot shows the 'PostgreSQL Unicode ODBC Driver (psqlODBC) Setup' dialog box. It contains the following fields and controls:

- Data Source:** PostgreSQL35W
- Description:** (empty text box)
- Database:** zoodb
- SSL Mode:** allow (dropdown menu)
- Server:** my-postgresql-server
- Port:** 5432
- User Name:** dbs-user
- Password:** (password field with 10 dots)
- Options:** Datasource, Global, Manage DSN (checkboxes)
- Buttons:** Test, Save, Cancel

6. Fill in the database connection credentials (these must be supplied by the database owner), and then click **Save**.

The connection is now available in the list of ODBC connections. To connect to the database, you can either double-click the connection or select it, and then click **Connect**.

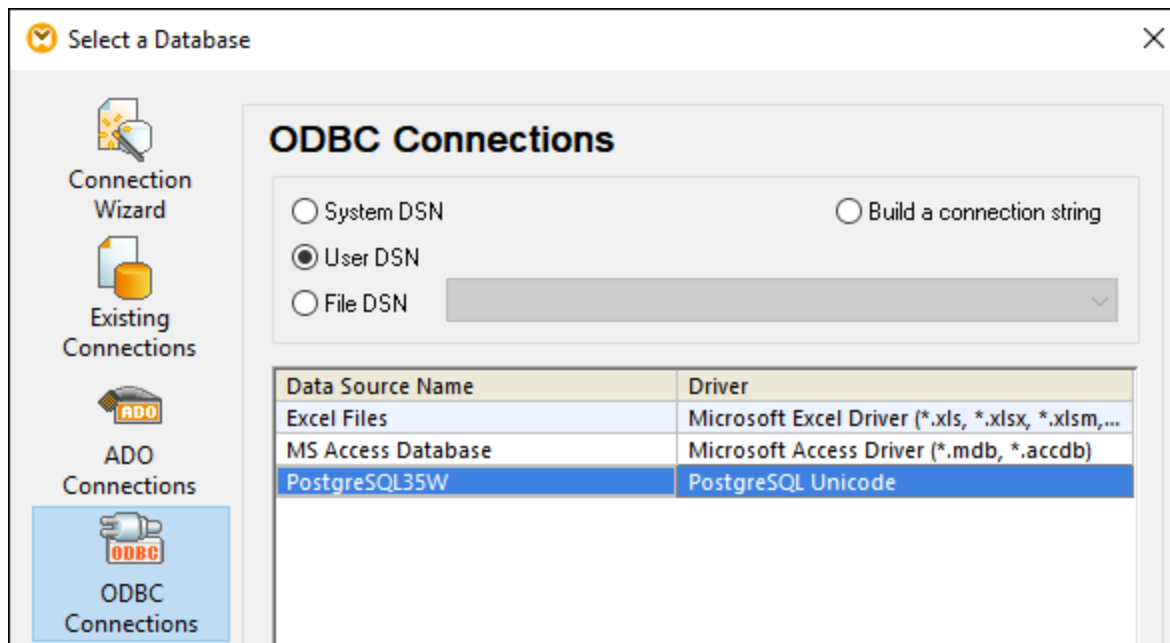

17.1.10.17 Progress OpenEdge (JDBC)

This example illustrates how to connect to a Progress OpenEdge 11.6 database server through JDBC.

Prerequisites

- JRE (Java Runtime Environment) or Java Development Kit (JDK) must be installed. This may be either Oracle JDK or an open source build such as Oracle OpenJDK. XMLSpy will determine the path to the Java Virtual Machine (JVM) from the following locations, in this order: a) The custom JVM path you may have set in application **Options**; b) The JVM path found in the Windows registry; c) The `JAVA_HOME` environment variable.
- Make sure that the platform of XMLSpy (32-bit, 64-bit) matches that of the JRE/JDK.
- The operating system's `PATH` environment variable must include the path to the `bin` directory of the JRE or JDK installation directory, for example `C:\Program Files (x86)\Java\jre1.8.0_51\bin`.
- The Progress OpenEdge JDBC driver must be available on your operating system. In this example, JDBC connectivity is provided by the **openedge.jar** and **pool.jar** driver component files available in **C:\Progress\OpenEdge\java** as part of the OpenEdge SDK installation.
- You have the following database connection details: host, port, database name, username, and password.

Connecting to OpenEdge through JDBC

1. [Start the database connection wizard](#) ⁶¹⁰.
2. Click **JDBC Connections**.
3. Next to "Classpaths", enter the path to the .jar file which provides connectivity to the database. If necessary, you can also enter a semicolon-separated list of .jar file paths. In this example, the required .jar file paths are: `C:\Progress\OpenEdge\java\openedge.jar;C:\Progress\OpenEdge\java\pool.jar`. Note that you can leave the "Classpaths" text box empty if you have added the .jar file path(s) to the CLASSPATH environment variable of the operating system (see also [Configuring the CLASSPATH](#) ⁶³⁴).
4. In the "Driver" box, select **com.ddtek.jdbc.openedge.OpenEdgeDriver**. Note that this entry is available if a valid .jar file path is found either in the "Classpaths" text box, or in the operating system's CLASSPATH environment variable (see the previous step).

Classpaths: C:\Progress\OpenEdge\java\openedge.jar;C:\Progress\OpenEd;

Driver: com.ddtek.jdbc.openedge.OpenEdgeDriver

Username: dbuser

Password: ●●●●●●

Database URL: jdbc:datadirect:openedge://localhost:8910;databaseName=obpsdev

Connect Close

5. Enter the username and password to the database in the corresponding text boxes.
6. Enter the connection string to the database server in the Database URL text box, by replacing the highlighted values with the ones applicable to your database server.

```
jdbc:datadirect:openedge://host:port;databaseName=db_name
```

7. Click **Connect**.

17.1.10.18 Progress OpenEdge (ODBC)

This example illustrates how to connect to a Progress OpenEdge database server through the Progress OpenEdge 11.6 ODBC driver.

Prerequisites:

- The *ODBC Connector for Progress OpenEdge* driver must be installed on your operating system. The Progress OpenEdge ODBC driver can be downloaded from the vendor's website (see also [Database Drivers Overview](#)⁶¹²). Make sure to download the 32-bit driver when running the 32-bit version of XMLSpy, and the 64-bit driver when running the 64-bit version. After installation, check if the ODBC driver is available on your machine (see also [Viewing the Available ODBC Drivers](#)⁶³⁰).

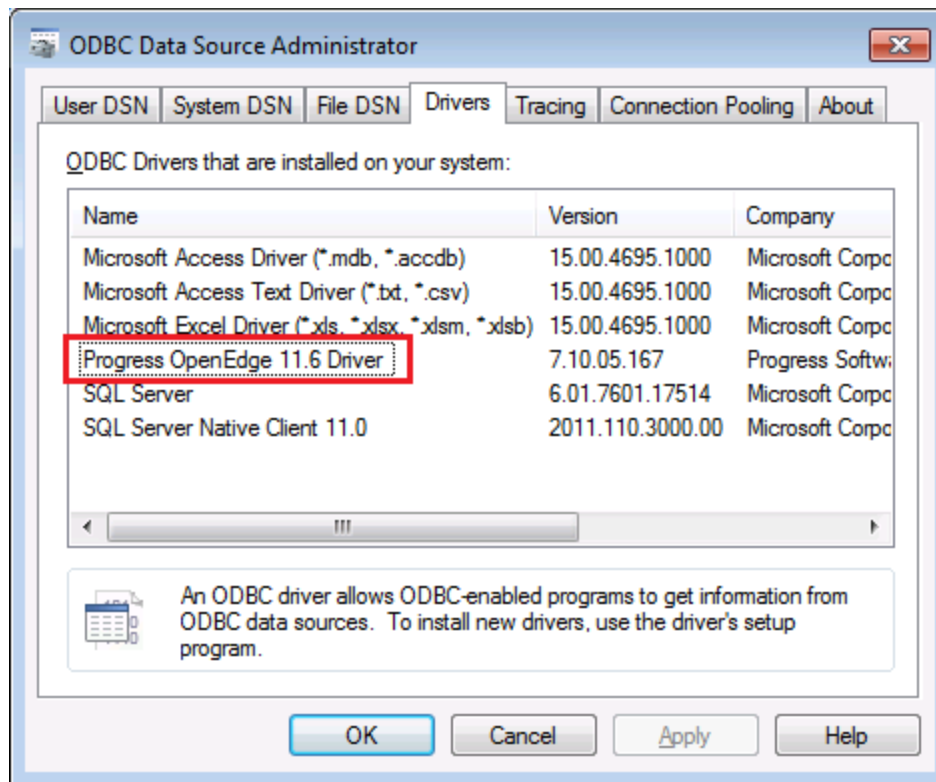

- You have the following database connection details: host name, port number, database name, user ID, and password.

Connecting to Progress OpenEdge through ODBC

1. [Start the database connection wizard](#) ⁶¹⁰.
2. Click **ODBC Connections**.
3. Click **User DSN** (alternatively, click **System DSN**, or **File DSN**, in which case the subsequent instructions will be similar).
4. Click **Add** .
5. Select the **Progress OpenEdge Driver** from the list, and click **User DSN** (or **System DSN**, if applicable).

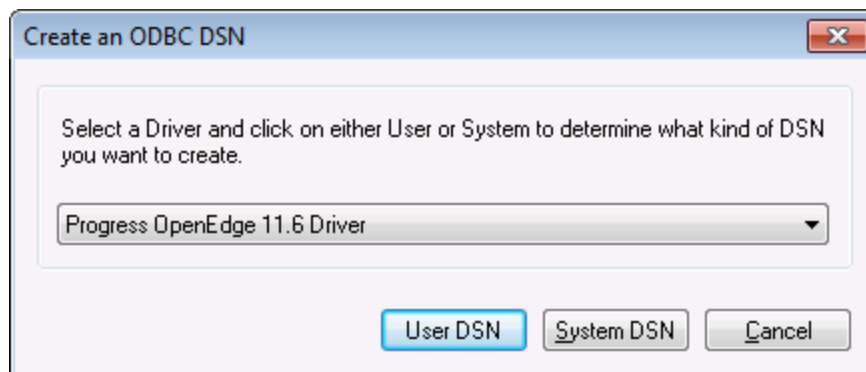

6. Fill in the database connection credentials (Database, Server, Port, User Name, Password), and then click **OK**. To verify connectivity before saving the entered data, click **Test Connect**.

The screenshot shows the 'ODBC Progress OpenEdge Wire Protocol Driver Setup' dialog box. It has a title bar with a question mark and a close button. Below the title bar are five tabs: 'General', 'Advanced', 'Security', 'Failover', and 'About'. The 'General' tab is selected. The dialog contains several input fields and buttons:

- Data Source Name:** my_progress_dsn
- Description:** (empty field)
- Host Name:** localhost
- Port Number:** 8910
- Database Name:** oebpsdev
- User ID:** altova

At the bottom of the dialog, there are four buttons: 'Test Connect', 'OK', 'Cancel', and 'Apply'. The 'OK' button is highlighted in blue.

7. Click OK. The new data source now appears in the list of ODBC data sources.

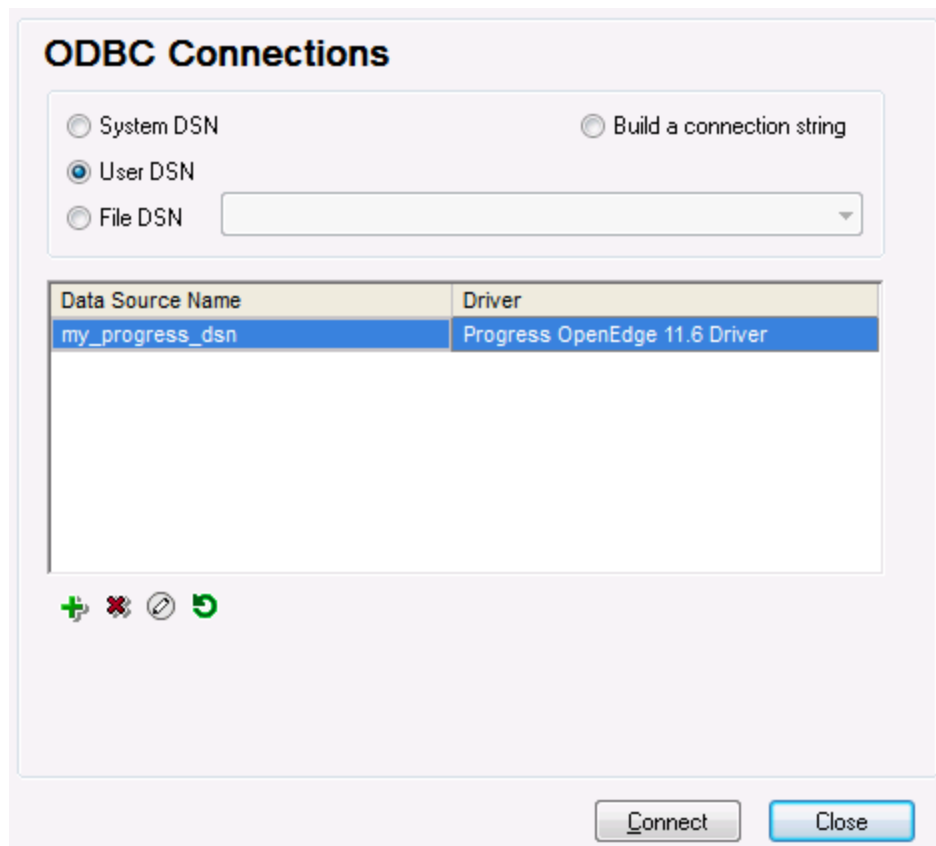

8. Click **Connect**.

17.1.10.19 Sybase (JDBC)

This example illustrates how to connect to a Sybase database server through JDBC.

Prerequisites:

- JRE (Java Runtime Environment) or Java Development Kit (JDK) must be installed. This may be either Oracle JDK or an open source build such as Oracle OpenJDK. XMLSpy will determine the path to the Java Virtual Machine (JVM) from the following locations, in this order: a) The custom JVM path you may have set in application **Options**; b) The JVM path found in the Windows registry; c) The `JAVA_HOME` environment variable.
- Make sure that the platform of XMLSpy (32-bit, 64-bit) matches that of the JRE/JDK.
- Sybase *jConnect* component must be installed on your operating system (in this example, *jConnect 7.0* is used, installed as part of the *Sybase Adaptive Server Enterprise PC Client* installation). For the installation instructions of the database client, refer to Sybase documentation.
- You have the following database connection details: host, port, database name, username, and password.

To connect to Sybase through JDBC:

1. [Start the database connection wizard](#) ⁶¹⁰.
2. Click **JDBC Connections**.
3. Next to "Classpaths", enter the path to the .jar file which provides connectivity to the database. If necessary, you can also enter a semicolon-separated list of .jar file paths. In this example, the required .jar file path is: **C:\sybase\jConnect-7_0\classes\jconn4.jar**. Note that you can leave the "Classpaths" text box empty if you have added the .jar file path(s) to the CLASSPATH environment variable of the operating system (see also [Configuring the CLASSPATH](#) ⁶³⁴).
4. In the "Driver" box, select **com.sybase.jdbc4.jdbc.SybDriver**. Note that this entry is available if a valid .jar file path is found either in the "Classpaths" text box, or in the operating system's CLASSPATH environment variable (see the previous step).

Classpaths: C:\sybase\jConnect-7_0\classes\jconn4.jar;

Driver: com.sybase.jdbc4.jdbc.SybDriver

Username: dbuser

Password: ●●●●●●

Database URL: jdbc:sybase:Tds:SYBASE12:2048/PRODUCTSDB

Connect Close

5. Enter the username and password to the database in the corresponding text boxes.
6. Enter the connection string to the database server in the Database URL text box, by replacing the highlighted values with the ones applicable to your database server.

```
jdbc:sybase:Tds:hostname:port/databaseName
```

7. Click **Connect**.

17.1.10.20 Teradata (JDBC)

This example illustrates how to connect to a Teradata database server through JDBC.

Prerequisites:

- JRE (Java Runtime Environment) or Java Development Kit (JDK) must be installed. This may be either Oracle JDK or an open source build such as Oracle OpenJDK. XMLSpy will determine the path to the Java Virtual Machine (JVM) from the following locations, in this order: a) The custom JVM path you may have set in application **Options**; b) The JVM path found in the Windows registry; c) The `JAVA_HOME` environment variable.
- Make sure that the platform of XMLSpy (32-bit, 64-bit) matches that of the JRE/JDK.
- The JDBC driver (one or more .jar files that provide connectivity to the database) must be available on your operating system. In this example, Teradata JDBC Driver 16.20.00.02 is used. For more information, see <https://downloads.teradata.com/download/connectivity/jdbc-driver>.
- You have the following database connection details: host, database, port, username, and password.

To connect to Teradata through JDBC:

1. [Start the database connection wizard](#)⁶¹⁰.
2. Click **JDBC Connections**.
3. Next to "Classpaths", enter the path to the .jar file which provides connectivity to the database. If necessary, you can also enter a semicolon-separated list of .jar file paths. In this example, the .jar files are located at the following path: **C:\jdbc\teradata**. Note that you can leave the "Classpaths" text box empty if you have added the .jar file path(s) to the CLASSPATH environment variable of the operating system (see also [Configuring the CLASSPATH](#)⁶³⁴).
4. In the "Driver" box, select **com.teradata.jdbc.TeraDriver**. Note that this entry is available if a valid .jar file path is found either in the "Classpath" text box, or in the operating system's CLASSPATH environment variable (see the previous step).

JDBC Connections

Enter a connection string and select (or enter manually) a valid JDBC driver. Click on 'Connect' to proceed.

Classpaths:

Driver:

Username:

Password:

Database URL:

5. Enter the username and password to the database in the corresponding text boxes.
6. Enter the connection string to the database server in the Database URL text box, by replacing the highlighted value with the one applicable to your database server.

```
jdbc:teradata://databaseServerName
```

7. Click **Connect**.

17.1.10.21 Teradata (ODBC)

This example illustrates how to connect to a Teradata database server through ODBC.

Prerequisites:

- The Teradata ODBC driver must be installed (see <https://downloads.teradata.com/download/connectivity/odbc-driver/windows>. This example uses Teradata ODBC Driver for Windows version 16.20.00.
- You have the following database connection details: host, username, and password.

To connect to Teradata through ODBC:

1. Press the **Windows** key, start typing "ODBC", and select **Set up ODBC data sources (32-bit)** from the list of suggestions. If you have a 64-bit ODBC driver, select **Set up ODBC data sources (64-bit)** and use 64-bit XMLSpy in the subsequent steps.

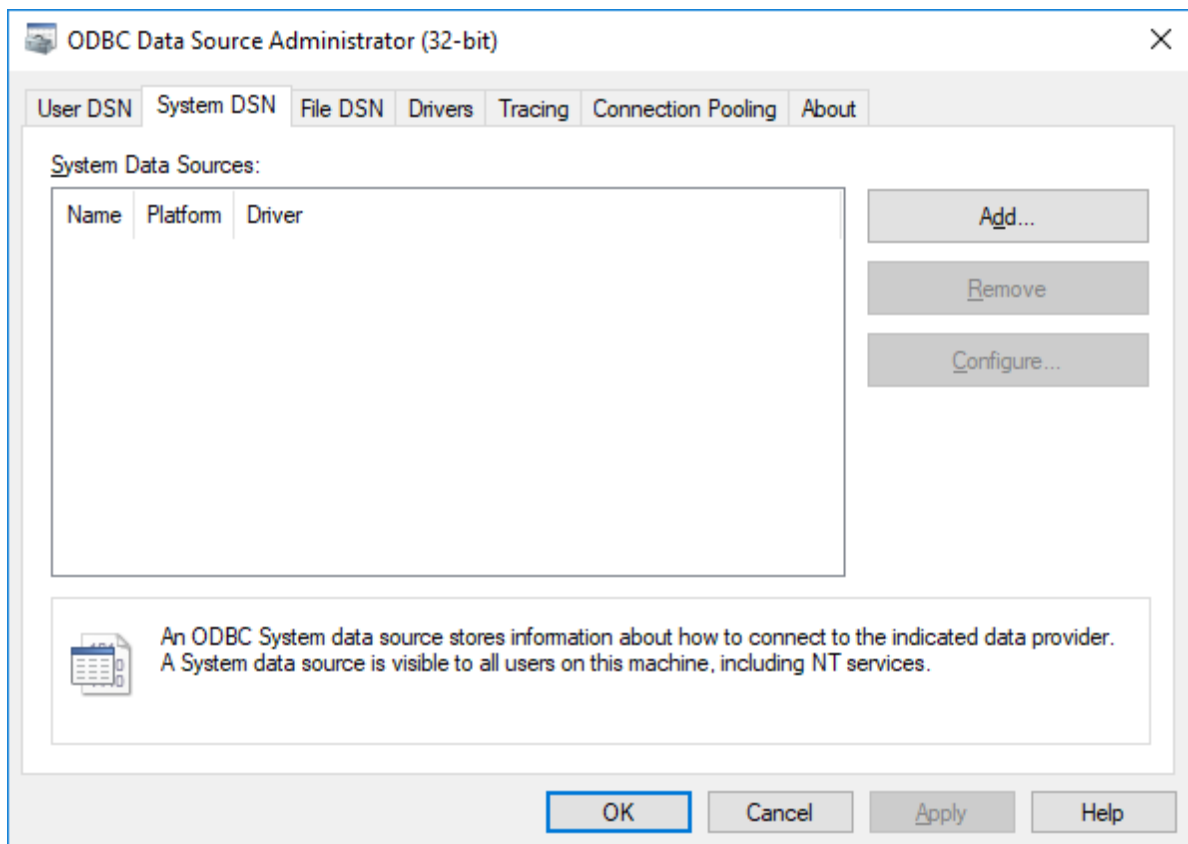

2. Click the **System DSN** tab, and then click **Add**.

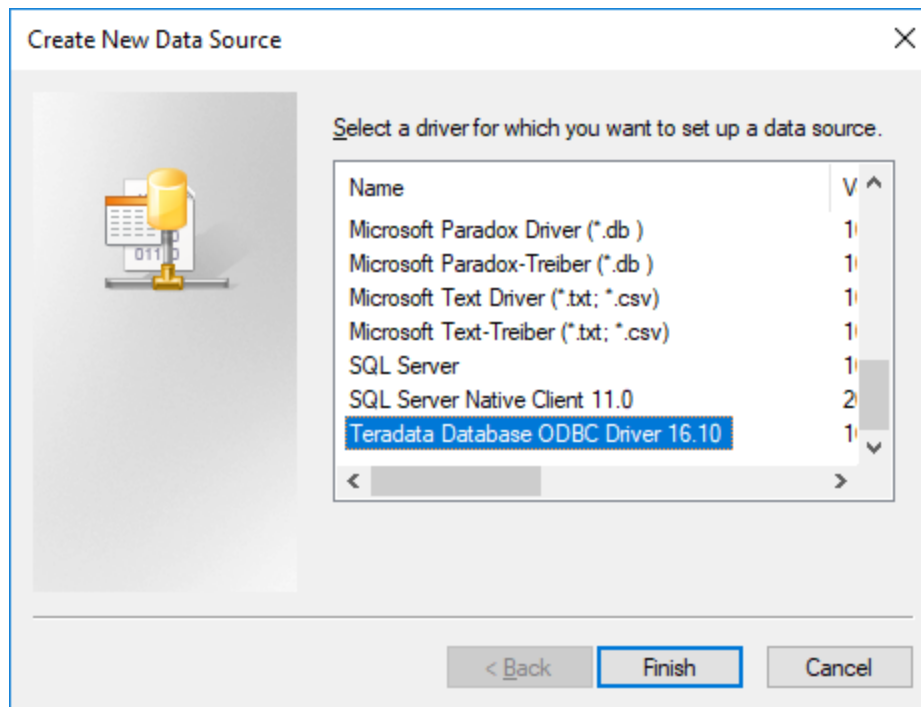

3. Select **Teradata Database ODBC Driver** and click **Finish**.

The screenshot shows the 'ODBC Driver Setup for Teradata Database' dialog box. It is divided into several sections:

- Data Source:** Contains a 'Name' field with the value 'my_teradata_source' and an empty 'Description' field. To the right are 'OK', 'Cancel', and 'Help' buttons.
- Teradata Server Info:** Contains a 'Name or IP address' dropdown menu with 'demoserver' selected.
- Authentication:** Features a 'Use Integrated Security' checkbox (unchecked). Below it is a 'Mechanism' dropdown menu. A 'Parameter' field is followed by a 'Change...' button. The 'Username' field contains 'demouser'. The 'Password' radio button is selected, with a corresponding password field containing ten dots. The 'Teradata Wallet String' radio button is unselected, with an empty text field next to it.
- Optional:** Contains a 'Default Database' field and an 'Account String' field, followed by an 'Options >>' button.
- Session Character Set:** A dropdown menu with 'UTF8' selected.

4. Enter name and, optionally, a description that will help you identify this ODBC data source in future. Also, enter the database connection credentials (Database server, User, Password), and, optionally, select a database.
5. Click **OK**. The data source now appears in the list.

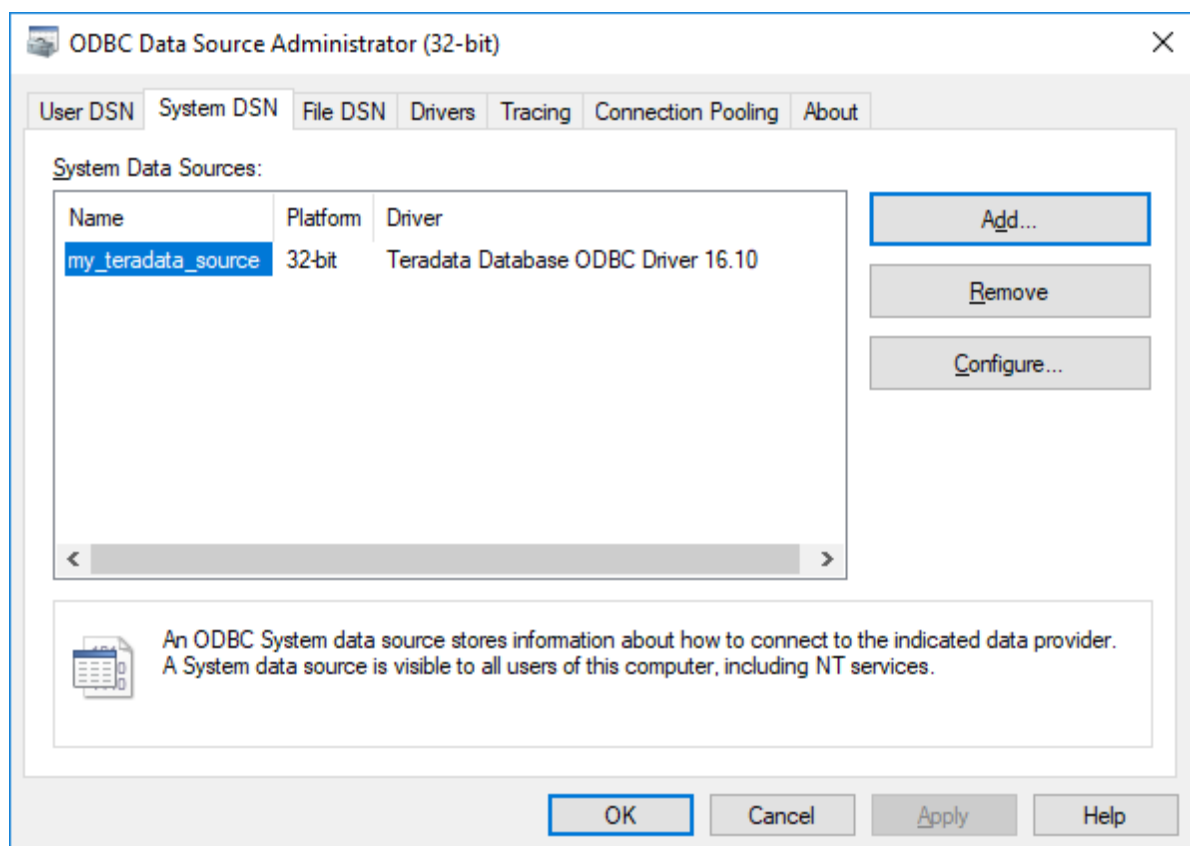

6. Run XMLSpy and [start the database connection wizard](#)⁶¹⁰.
7. Click **ODBC Connections**.

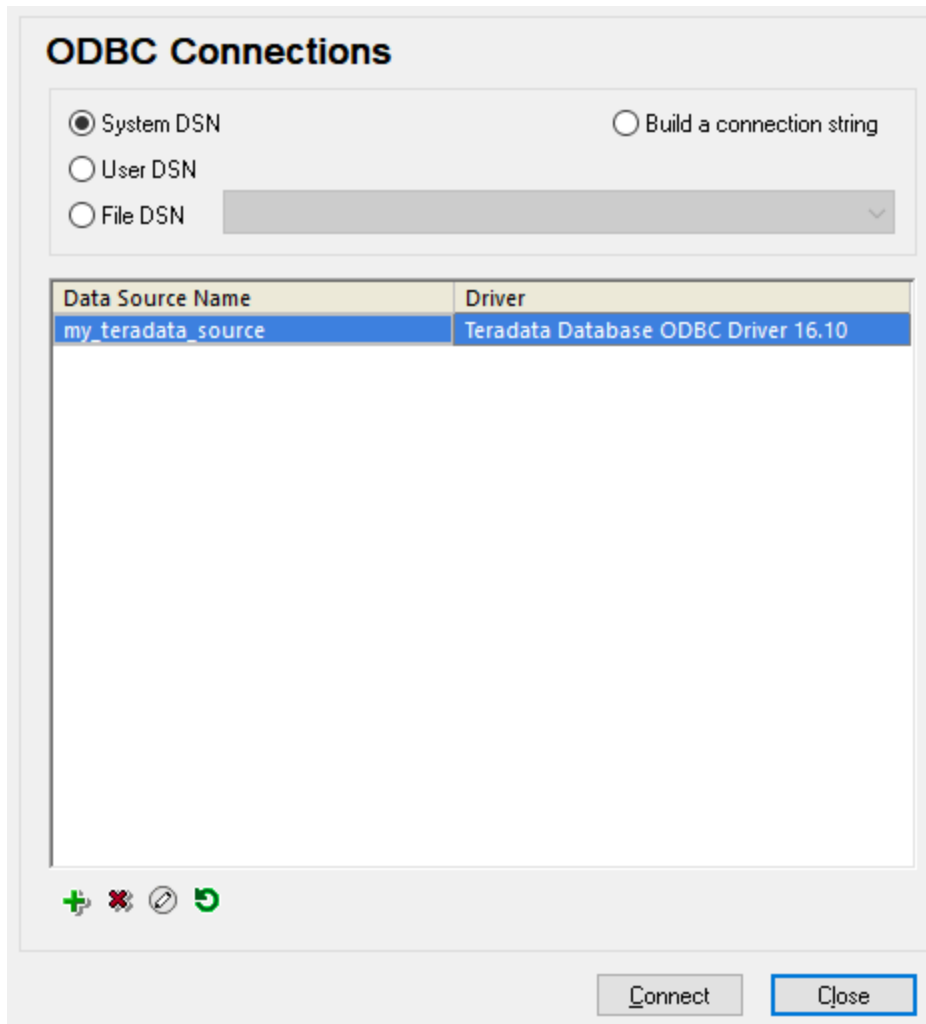

8. Click **System DSN**, select the data source created previously, and then click **Connect**.

Note: If you get the following error: "The driver returned invalid (or failed to return) SQL_DRIVER_ODBC_VER: 03.80", make sure that the path to the ODBC client (for example, **C:\Program Files\Teradata\Client\16.10\bin**, if you installed it to this location) exists in your system's PATH environment variable. If this path is missing, add it manually.

17.2 Supported Databases

The table below lists all the supported databases. If your Altova application is a 64-bit version, ensure that you have access to the 64-bit database drivers needed for the specific database you are connecting to.

| Database | Notes |
|--|---|
| Firebird 2.x, 3.x, 4.x | |
| IBM DB2 8.x, 9.x, 10.x, 11.x | |
| IBM Db2 for i 6.x, 7.4, 7.5 | Logical files are supported and shown as views. |
| IBM Informix 11.70 and later | |
| MariaDB 10 and later | MariaDB supports native connections. No separate drivers are required. |
| Microsoft Access 2003 and later | At the time of writing (early September 2019), there is no Microsoft Access Runtime available for Access 2019. You can connect to an Access 2019 database from Altova products only if Microsoft Access 2016 Runtime is installed and only if the database does not use the "Large Number" data type. |
| Microsoft Azure SQL Database | SQL Server 2016 codebase |
| Microsoft SQL Server 2005 and later
Microsoft SQL Server on Linux | |
| MySQL 5 and later | MySQL 5.7 and later supports native connections. No separate drivers are required. |
| Oracle 9i and later | |
| PostgreSQL 8 and later | PostgreSQL connections are supported both as native connections and driver-based connections through interfaces (drivers) such as ODBC or JDBC. Native connections do not require any drivers. |
| Progress OpenEdge 11.6 | |
| SQLite 3.x | SQLite connections are supported as native, direct connections to the SQLite database file. No separate drivers are required.

In Authentic view, data coming from a SQLite database is not editable. When you attempt to save SQLite data from the Authentic view, a message box will inform you of this known limitation. |
| Sybase ASE 15, 16 | |
| Teradata 16 | |

18 Altova Global Resources

Altova Global Resources is a collection of aliases for file, folder, and database resources. Each alias can have multiple configurations, and each configuration maps to a single resource (see *screenshot below*). Therefore, when a global resource is used as an input, the global resource can be switched among its configurations. This is done easily via controls in the GUI that let you select the active configuration. For example, if an XSLT stylesheet for transforming an XML document is assigned via a global resource (an alias), then we can set up multiple configurations for the global resource, each of which points to a different XSLT file. After setting up the global resource in this way, switching the configuration would switch the XSLT file used for the transformation.

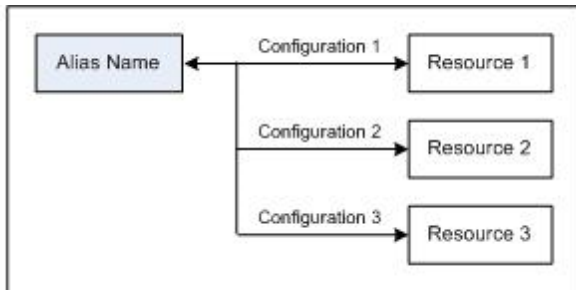

A global resource can not only be used to switch resources within an Altova application, but also to generate and use resources from other Altova applications. So, files can be generated on-the-fly in one Altova application for use in another Altova application. All of this tremendously eases and speeds up development and testing. For example, an XSLT stylesheet in XMLSpy can be used to transform an XML file generated on-the-fly by an Altova MapForce mapping.

Using Altova Global Resources involves two processes:

- [Defining Global Resources](#)⁶⁹⁷: Resources are defined and the definitions are stored in an XML file. These resources can be shared across multiple Altova applications.
- [Using Global Resources](#)⁷⁰⁸: Within XMLSpy, files can be located via a global resource instead of via a file path. The advantage is that the resource can be switched by changing the active configuration in XMLSpy.

Global resources in other Altova products

Currently, global resources can be defined and used in the following individual Altova products: XMLSpy, StyleVision, MapForce, Authentic Desktop, MobileTogether Designer, and DatabaseSpy.

18.1 Defining Global Resources

Altova Global Resources are defined in the Manage Global Resources dialog, which can be accessed in two ways:

- Click the menu command **Tools | Global Resources**.
- Click the **Manage Global Resources** icon in the Global Resources toolbar (*screenshot below*).



The Global Resources Definitions file

Information about global resources is stored in an XML file called the Global Resources Definitions file. This file is created when the first global resource is defined in the Manage Global Resources dialog (*screenshot below*) and saved.

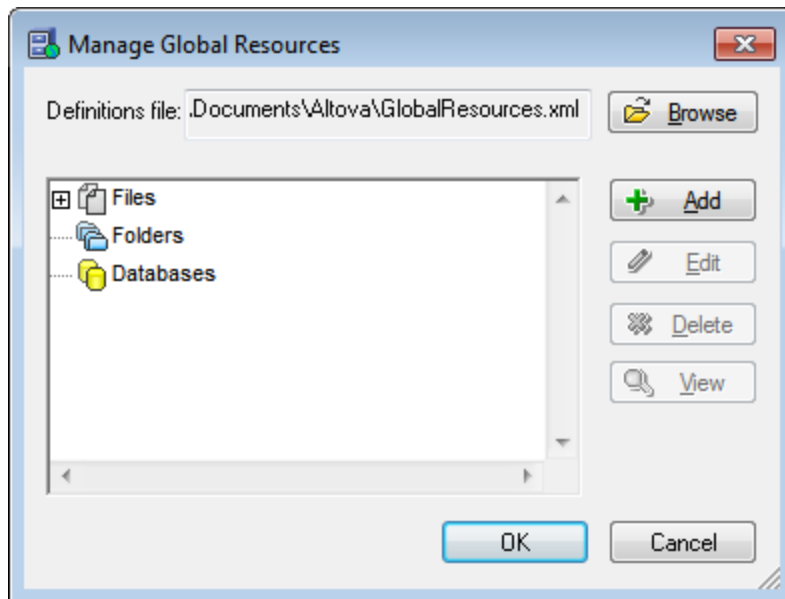

When you open the Manage Global Resources dialog for the first time, the default location and name of the Global Resources Definitions file is specified in the *Definitions File* text box (*see screenshot above*):

```
C:\Users\\My Documents\Altova\GlobalResources.xml
```

This file is set as the default Global Resources Definitions file for all Altova applications. So a global resource can be saved from any Altova application to this file and will be immediately available to all other Altova applications as a global resource. To define and save a global resource to the Global Resources Definitions file, add the global resource in the Manage Global Resources dialog and click **OK** to save.

To select an already existing Global Resources Definitions file to be the active definitions file of a particular Altova application, browse for it via the **Browse** button of the *Definitions File* text box (*see screenshot above*).

Note: You can name the Global Resources Definitions file anything you like and save it to any location accessible to your Altova applications. All you need to do in each application, is specify this file as the Global Resources Definitions file for that application (in the *Definitions File* text box). The resources become global across Altova products when you use a single definitions file across all Altova products.

Note: You can also create multiple Global Resources Definitions files. However, only one of these can be active at any time in a given Altova application, and only the definitions contained in this file will be available to the application. The availability of resources can therefore be restricted or made to overlap across products as required.

Managing global resources: adding, editing, deleting, saving

In the Manage Global Resources dialog (*screenshot above*), you can add a global resource to the selected Global Resources Definitions file, or edit or delete a selected global resource. The Global Resources Definitions file organizes the global resources you add into groups: of files, folders, and databases (*see screenshot above*).

To **add a global resource**, click the **Add** button and define the global resource in the appropriate Global Resource dialog that pops up (*see the descriptions of [files](#)⁶⁹⁹, [folders](#)⁷⁰⁴, and [databases](#)⁶⁹⁷ in the sub-sections of this section*). After you define a global resource and save it (by clicking **OK** in the Manage Global Resources dialog), the global resource is added to the library of global definitions in the selected Global Resources Definitions file. The global resource will be identified by an alias.

To **edit a global resource**, select it and click **Edit**. This pops up the relevant Global Resource dialog, in which you can make the necessary changes (*see the descriptions of [files](#)⁶⁹⁹, [folders](#)⁷⁰⁴, and [databases](#)⁷⁰⁶ in the sub-sections of this section*).

To **delete a global resource**, select it and click **Delete**.

After you finish adding, editing, or deleting, make sure to click **OK** in the Manage Global Resources dialog to **save your modifications** to the Global Resources Definitions file.

Relating global resources to alias names via configurations

Defining a global resource involves mapping an alias name to a resource (file, folder, or database). A single alias name can be mapped to multiple resources. Each mapping is called a configuration. A single alias name can therefore be associated with several resources via different configurations (*screenshot below*).

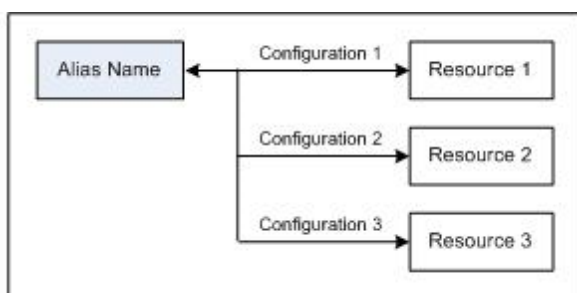

In an Altova application, you can then assign aliases instead of files. For each alias you can switch between the resources mapped to that alias simply by changing the application's active Global Resource configuration (active configuration). For example, in Altova's XMLSpy application, if you wish to run an XSLT transformation on the XML document `MyXML.xml`, you can assign the alias `MyXSLT` to it as the global resource to be used for XSLT transformations. In XMLSpy you can then change the active configuration to use different XSLT files. If `Configuration-1` maps `First.xslt` to `MyXSLT` and `Configuration-1` is selected as the active configuration, then `First.xslt` will be used for the transformation. In this way multiple configurations can be used to access multiple resources via a single alias. This mechanism can be useful when testing and comparing resources. Furthermore, since global resources can be used across Altova products, resources can be tested and compared across multiple Altova products as well.

18.1.1 Files

The Global Resource dialog for Files (*screenshot below*) is accessed via the **Add | File** command in the [Manage Global Resources dialog](#)⁶⁹⁷. In this dialog, you can define configurations of the alias that is named in the *Resource Alias* text box. After specifying the properties of the configurations as explained below, save the alias definition by clicking **OK**.

After saving an alias definition, you can add another alias by repeating the steps given above (starting with the **Add | File** command in the [Manage Global Resources dialog](#)⁶⁹⁷).

Global Resource dialog

An alias is defined in the Global Resource dialog (*screenshot below*).

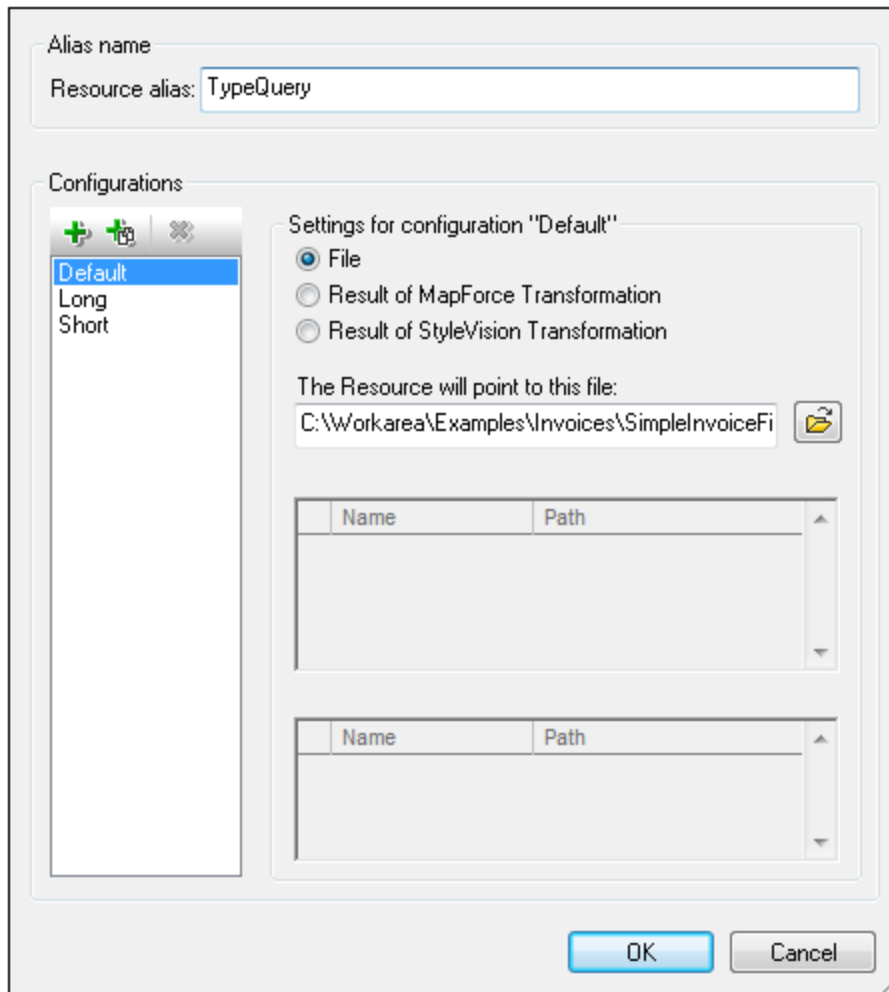

Global Resource dialog icons



Add Configuration: Pops up the Add Configuration dialog in which you enter the name of the configuration to be added.



Add Configuration as Copy: Pops up the Add Configuration dialog in which you can enter the name of the configuration to be created as a copy of the selected configuration.



Delete: Deletes the selected configuration.



Open: Browse for the file to be created as the global resource.

Defining the alias

Define the alias (its name and configurations) as follows:

1. **Give the alias a name:** Enter the alias name in the *Resource Alias* text box.

2. **Add configurations:** The Configurations pane will have, by default, a configuration named `Default` (see screenshot above), which cannot be deleted or renamed. You can add as many additional configurations as you like by: (i) clicking the **Add Configuration** or **Add Configuration as Copy** icons, and (ii) giving the configuration a name in the dialog that pops up. Each added configuration will be shown in the Configurations list. In the screenshot above, two additional configurations, named `Long` and `Short`, have been added to the Configurations list. The Add Configuration as Copy command enables you to copy the selected configuration and then modify it.
3. **Select a resource type for each configuration:** Select a configuration from the Configurations list, and, in the *Settings for Configuration* pane, specify a resource for the configuration: (i) File, (ii) Output of an Altova MapForce transformation, or (iii) Output of an Altova StyleVision transformation. Select the appropriate radio button. If a MapForce or StyleVision transformation option is selected, then a transformation is carried out by MapForce or StyleVision using, respectively, the `.mfd` or `.sps` file and the respective input file. The result of the transformation will be the resource.
4. **Select a file for the resource type:** If the resource is a directly selected file, browse for the file in the *Resource File Selection* text box. If the resource is the result of a transformation, in the *File Selection* text box, browse for the `.mfd` file (for MapForce transformations) or the `.sps` file (for StyleVision transformations). Where multiple inputs or outputs for the transformation are possible, a selection of the options will be presented. For example, the output options of a StyleVision transformation are displayed according to what edition of StyleVision is installed (*the screenshot below shows the outputs for Enterprise Edition*).

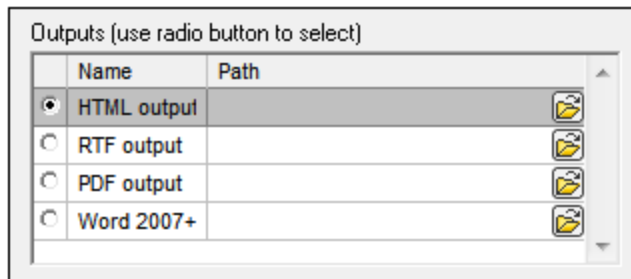

Select the radio button of the desired option (in the screenshot above, 'HTML output' is selected). If the resource is the result of a transformation, then the output can be saved as a file or itself as a global resource. Click the  icon and select, respectively, Global Resource (for saving the output as a global resource) or Browse (for saving the output as a file). If neither of these two saving options is selected, the transformation result will be loaded as a temporary file when the global resource is invoked.

5. **Define multiple configurations if required:** You can add more configurations and specify a resource for each. Do this by repeating Steps 3 and 4 above for each configuration. You can add a new configuration to the alias definition at any time.
6. **Save the alias definition:** Click **OK** to save the alias and all its configurations as a global resource. The global resource will be listed under Files in the [Manage Global Resources dialog](#) ⁶⁹⁷.

Result of MapForce transformation

Altova MapForce maps one or more (existing) input document schemas to one or more (new) output document schemas. This mapping, which is created by a MapForce user, is known as a MapForce Design (MFD). XML files, text files, databases, etc., that correspond to the input schema/s can be used as data sources. MapForce generates output data files that correspond to the output document schema. This output document is the *Result of MapForce Transformation* file that will become a global resource.

If you wish to set a MapForce-generated data file as a global resource, the following must be specified in the Global Resource dialog (see screenshot below):

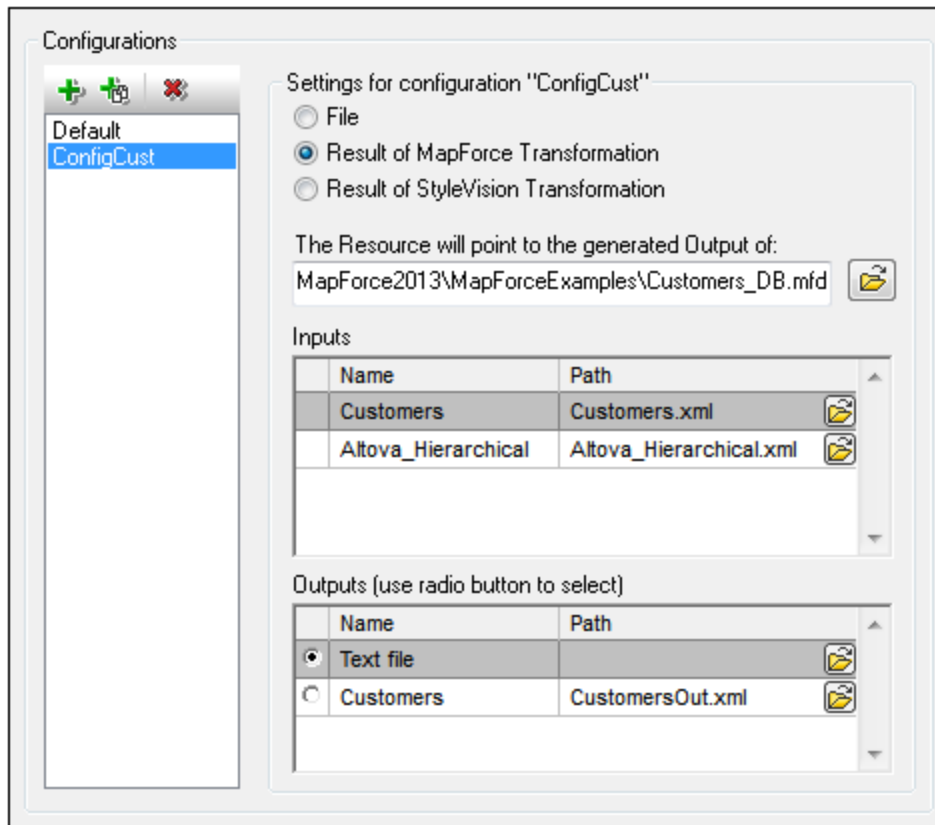

- **A .mfd (MapForce Design) file.** You must specify this file in the *Resource will point to generated output of* text box (see screenshot above).
- **One or more input data files.** After the MFD file has been specified, it is analyzed and, based on the input schema information in it, default data file/s are entered in the *Inputs* pane (see screenshot above). You can modify the default file selection for each input schema by specifying another file.
- **An output file.** If the MFD document has multiple output schemas, all these are listed in the *Outputs* pane (see screenshot above) and you must select one of them. If the output file location of an individual output schema is specified in the MFD document, then this file location is entered for that output schema in the *Outputs* pane. From the screenshot above we can see that the MFD document specifies that the `Customers` output schema has a default XML data file (`CustomersOut.xml`), while the `Text file` output schema does not have a file association in the MFD file. You can use the default file location in the *Outputs* pane or specify one yourself. The result of the MapForce transformation will be saved to the file location of the selected output schema. This is the file that will be used as the global resource

Note: The advantage of this option (Result of MapForce transformation) is that the transformation is carried out at the time the global resource is invoked. This means that the global resource will contain the most up-to-date data (from the input file/s).

Note: Since MapForce is used to run the transformation, you must have Altova MapForce installed for this functionality to work.

Result of StyleVision transformation

Altova StyleVision is used to create StyleVision Power Stylesheet (SPS) files. These SPS files generate XSLT stylesheets that are used to transform XML documents into output documents in various formats (HTML, PDF, RTF, Word 2007+, etc). If you select the option *Result of StyleVision Transformation*, the output document created by StyleVision will be the global resource associated with the selected configuration.

For the *StyleVision Transformation* option in the Global Resource dialog (see screenshot below), the following files must be specified.

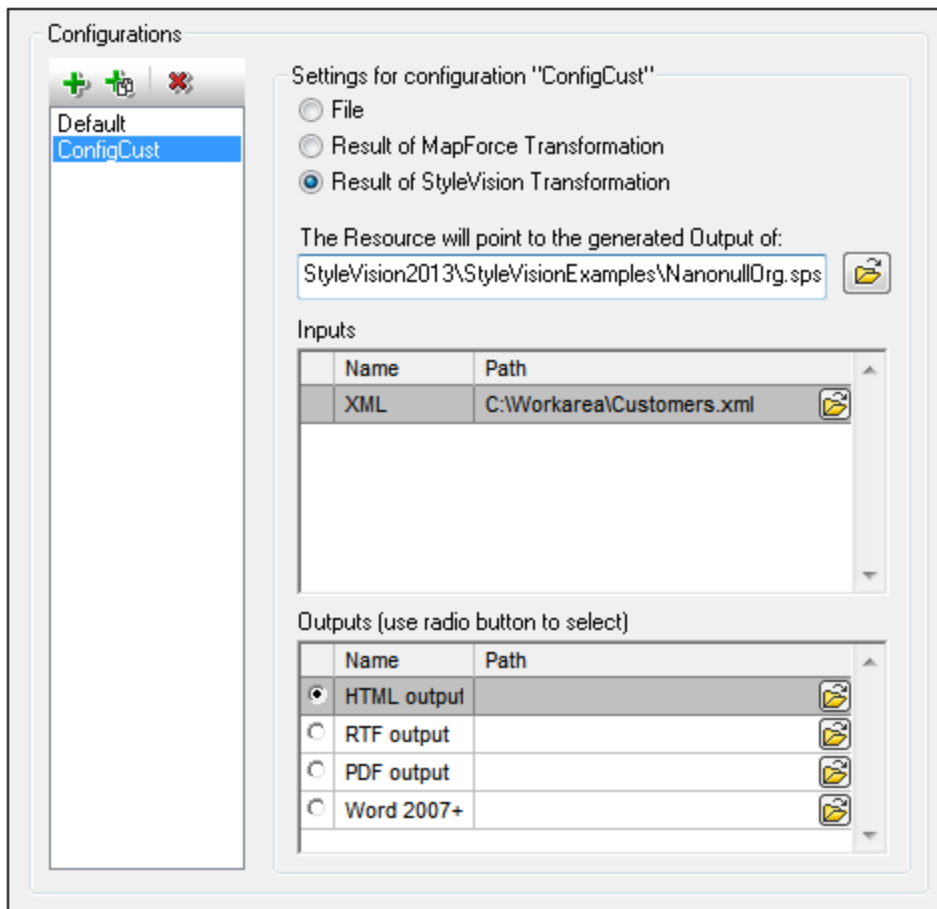

- **A .sps (SPS) file.** You must specify this file in the *Resource will point to generated output of* text box (see screenshot above).
- **Input file/s.** The input file might already be specified in the SPS file. If it is, it will appear automatically in the *Inputs* pane once the SPS file is selected. You can change this entry. If there is no entry, you must add one.
- **Output file/s.** Select the output format in the *Outputs* pane, and specify an output file location for that format.

Note: The advantage of this option (Result of StyleVision transformation) is that the transformation is carried out when the global resource is invoked. This means that the global resource will contain the most up-to-date data (from the input file/s).





Note: Since StyleVision is used to run the transformation, you must have Altova StyleVision installed for this functionality to work.

18.1.2 Folders

In the Global Resource dialog for Folders (*screenshot below*), add a folder resource as described below.



Global Resource dialog icons

-  **Add Configuration:** Pops up the Add Configuration dialog in which you enter the name of the configuration to be added.
-  **Add Configuration as Copy:** Pops up the Add Configuration dialog in which you can enter the name of the configuration to be created as a copy of the selected configuration.
-  **Delete:** Deletes the selected configuration.
-  **Open:** Browse for the folder to be created as the global resource.

Defining the alias

Define the alias (its name and configurations) as follows:

1. *Give the alias a name:* Enter the alias name in the *Resource Alias* text box.

2. *Add configurations:* The Configurations pane will have a configuration named Default (see screenshot above). This Default configuration cannot be deleted nor have its name changed. You can enter as many additional configurations for the selected alias as you like. Add a configuration by clicking the **Add Configuration** or **Add Configuration as Copy** icons. In the dialog which pops up, enter the configuration name. Click **OK**. The new configuration will be listed in the Configurations pane. Repeat for as many configurations as you want.
3. *Select a folder as the resource of a configuration:* Select one of the configurations in the Configurations pane and browse for the folder you wish to create as a global resource. If security credentials are required to access a folder, then specify these in the *Username* and *Password* fields.
4. *Define multiple configurations if required:* Specify a folder resource for each configuration you have created (that is, repeat Step 3 above for the various configurations you have created). You can add a new configuration to the alias definition at any time.
5. *Save the alias definition:* Click **OK** in the Global Resource dialog to save the alias and all its configurations as a global resource. The global resource will be listed under Folders in the [Manage Global Resources dialog](#)⁶⁹⁷.

18.1.3 Databases

In the Global Resource dialog for Databases (*screenshot below*), you can add a database resource as follows:

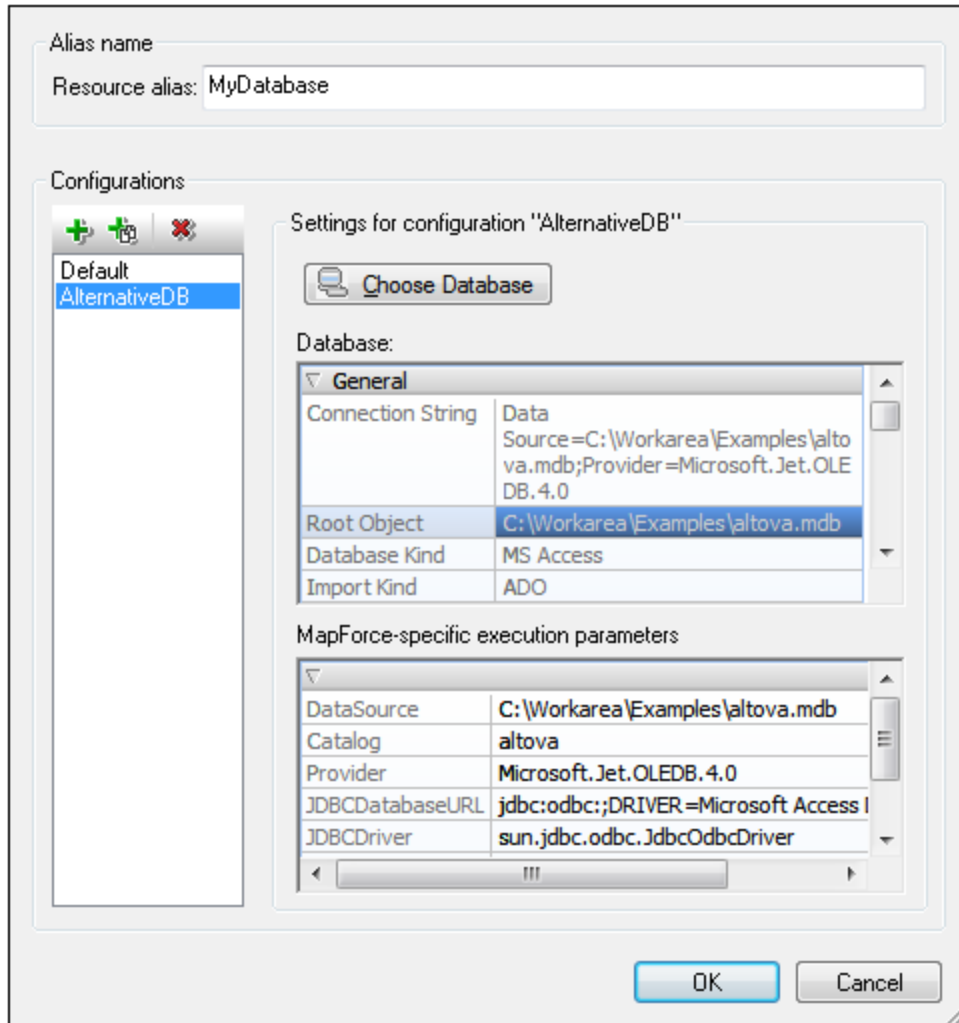

Global Resource dialog icons



Add Configuration: Pops up the Add Configuration dialog in which you enter the name of the configuration to be added.



Add Configuration as Copy: Pops up the Add Configuration dialog in which you can enter the name of the configuration to be created as a copy of the selected configuration.



Delete: Deletes the selected configuration.

Defining the alias

Define the alias (its name and configurations) as follows:

1. *Give the alias a name:* Enter the alias name in the *Resource Alias* text box.
2. *Add configurations:* The Configurations pane will have a configuration named Default (see *screenshot above*). This Default configuration cannot be deleted nor have its name changed. You can enter as many additional configurations for the selected alias as you like. Add a configuration by clicking the **Add Configuration** or **Add Configuration as Copy** icons. In the dialog which pops up, enter the configuration name. Click **OK**. The new configuration will be listed in the Configurations pane. Repeat for as many configurations as you want.
3. *Start selection of a database as the resource of a configuration:* Select one of the configurations in the Configurations pane and click the **Choose Database** icon. This pops up the Create Global Resources Connection dialog.
4. *Connect to the database:* Select whether you wish to create a connection to the database using the Connection Wizard, an existing connection, an ADO Connection, an ODBC Connection, or JDBC Connection. Complete the definition of the connection method as described in the section [Connecting to a Database](#)⁶¹⁰. If a connection has already been made to a database from XMLSpy, you can click the Existing Connections icon and select the DB from the list of connections that is displayed.
5. *Select the root object:* If you connect to a database server where a root object can be selected, you will be prompted, in the Choose Root Object dialog (*screenshot below*), to select a root object on the server. Select the root object and click **Set Root Object**. The root object you select will be the root object that is loaded when this configuration is used.

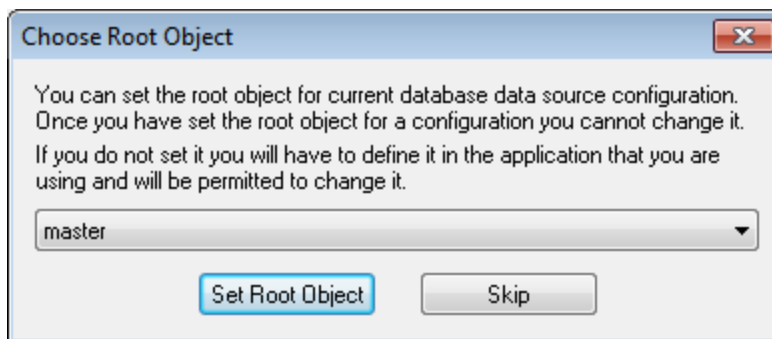

If you choose not to select a root object (by clicking the **Skip** button), then you can select the root object at the time the global resource is loaded.

6. *Define multiple configurations if required:* Specify a database resource for any other configuration you have created (that is, repeat Steps 3 to 5 above for the various configurations you have created). You can add a new configuration to the alias definition at any time.
7. *Save the alias definition:* Click **OK** in the Global Resource dialog to save the alias and all its configurations as a global resource. The global resource will be listed under databases in the Manage Global Resources dialog.

18.2 Using Global Resources

There are several types of global resources (file-type, folder-type, and database-type). Some scenarios in which you can use global resources in XMLSpy are listed here: [Files and Folders](#)⁷⁰⁸ and [Databases](#)⁷¹¹.

Selections that determine which resource is used

There are two application-wide selections that determine what global resources can be used and which global resources are actually used at any given time:

- *The active Global Resources XML File* is selected in the [Global Resource dialog](#)⁶⁹⁷. The global-resource definitions that are present in the active Global Resources XML File are available to all files that are open in the application. Only the definitions in the active Global Resources XML File are available. The active Global Resources XML File can be changed at any time, and the global-resource definitions in the new active file will immediately replace those of the previously active file. The active Global Resources XML File therefore determines: (i) what global resources can be assigned, and (ii) what global resources are available for look-up (for example, if a global resource in one Global Resource XML File is assigned but there is no global resource of that name in the currently active Global Resources XML File, then the assigned global resource (alias) cannot be looked up).
- *The active configuration* is selected via the menu item [Tools | Active Configuration](#)¹⁰¹⁸ or via the Global Resources toolbar. Clicking this command (or drop-down list in the toolbar) pops up a list of configurations across all aliases. Selecting a configuration makes that configuration active application-wide. This means that wherever a global resource (or alias) is used, the resource corresponding to the active configuration of each used alias will be loaded. The active configuration is applied to all used aliases. If an alias does not have a configuration with the name of the active configuration, then the default configuration of that alias will be used. The active configuration is not relevant when assigning resources; it is significant only when the resources are actually used.

18.2.1 Assigning Files and Folders

File-type and folder-type global resources are assigned differently. In any one of the usage scenarios below, clicking the **Global Resources** button displays the Open Global Resource dialog (*screenshot below*).

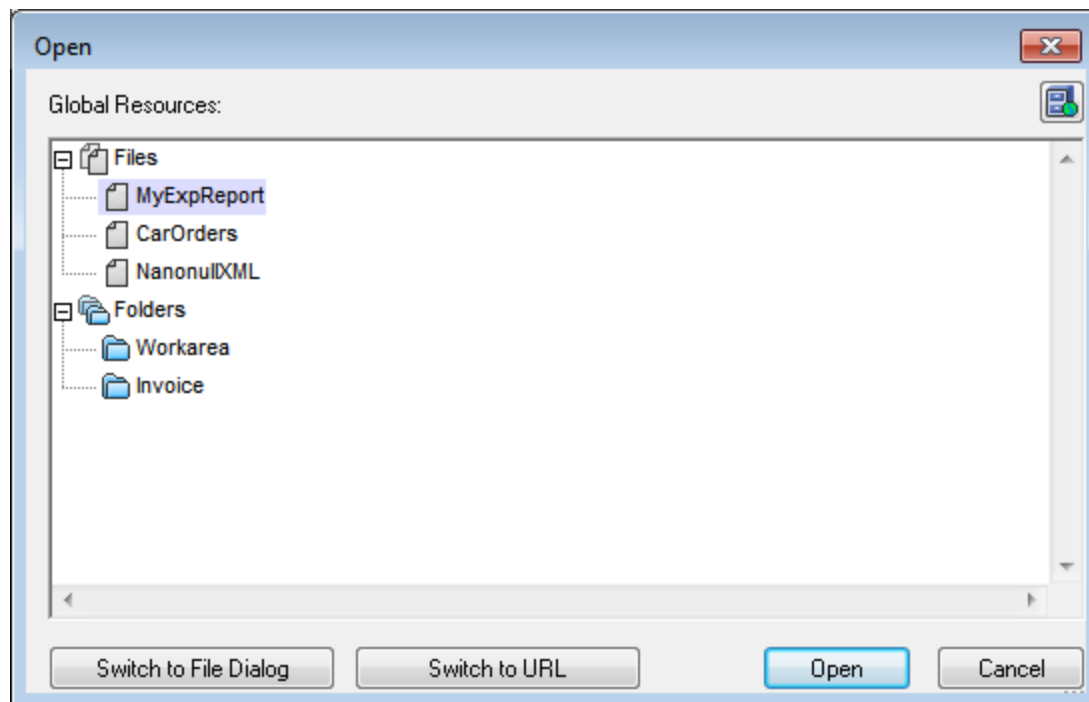

Manage Global Resources: Displays the [Manage Global Resources](#)⁶⁹⁷ dialog.

Selecting a *file-type global resource* assigns the file. Selecting a *folder-type global resource* causes an Open dialog to open, in which you can browse for the required file. The path to the selected file is entered relative to the folder resource. So if a folder-type global resource were to have two configurations, each pointing to different folders, files having the same name but in different folders could be targeted via the two configurations. This could be useful for testing purposes.

You can switch to the file dialog or the URL dialog by clicking the respective button at the bottom of the dialog. The **Manage Global Resources** icon in the top right-hand corner pops up the [Manage Global Resources](#)⁶⁹⁷ dialog.

Usage scenarios

File-type and folder-type global resources can be used in the following scenarios:

- [Opening global resources](#)⁷¹⁰
- [Saving as global resource](#)⁷¹⁰
- [Assigning files for XSLT transformations](#)⁷¹¹
- [XSLT transformation](#)⁷¹¹
- [XQuery executions](#)⁷¹¹
- [Assigning an SPS](#)⁷¹¹

Opening global resources

A global resource can be opened in XMLSpy with the [File | Open \(Switch to Global Resource\)](#)⁷⁸⁷ command and can be edited. In the case of a file-type global resource, the file is opened directly. In the case of a folder-type global resource, an Open dialog pops up with the associated folder selected. You can then browse for the required file in descendant folders. One advantage of addressing files for editing via global resources is that related files can be saved under different configurations of a single global resource and accessed merely by changing configurations. Any editing changes would have to be saved before changing the configuration.

Saving as global resource

A newly created file can be saved as a global resource. Also, an already existing file can be opened and then saved as a global resource. When you click the **File | Save** or **File | Save As** commands, the Save dialog appears. Click the **Global Resource** button to access the available global resources (*screenshot below*), which are the aliases defined in the current Global Resources XML File.

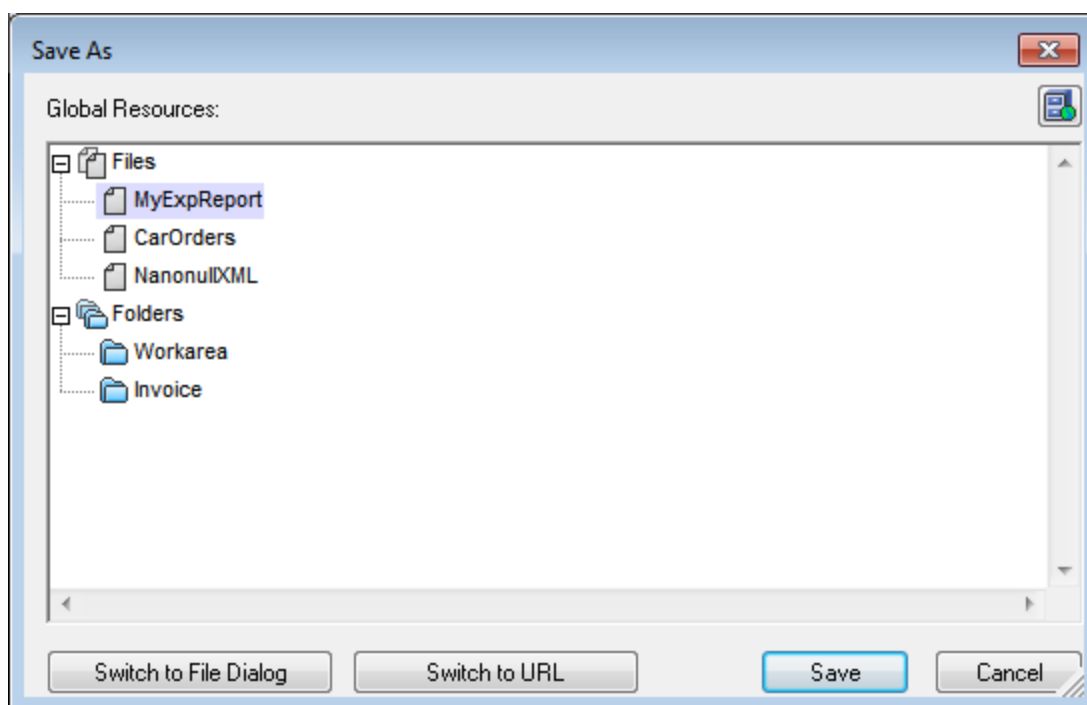

Select an alias and then click **Save**. If the alias is a [file alias](#)⁶⁹⁹, the file will be saved directly. If the alias is a [folder alias](#)⁷⁰⁴, a dialog will appear that prompts for the name of the file under which the file is to be saved. In either case the file will be saved to the location that was defined for the [currently active configuration](#)⁷¹².

Note: Each configuration points to a specific file location, which is specified in the definition of that configuration. If the file you are saving as a global resource does not have the same filetype extension as the file at the current file location of the configuration, then there might be editing and validation errors when this global resource is opened in XMLSpy. This is because XMLSpy will open the file assuming the filetype specified in the definition of the configuration.

Assigning files for XSLT transformations

XSLT files can be assigned to XML documents and XML files to XSLT documents via global resources.. When the commands for assigning XSLT files ([XSL/XQuery | Assign XSL](#)⁹¹³ and [XSL/XQuery | Assign XSL:FO](#)⁹¹⁴) and XML files ([XSL/XQuery | Assign Sample XML](#)⁹¹⁴) are clicked the assignment dialog pops up. Clicking the **Browse** button pops up the Open dialog, in which you can switch to the Open Global Resource dialog and select the required global resource. A major advantage of using a global resource to specify files for XSLT transformations is that the XSLT file (or XML file) can be changed for a transformation merely by changing the active configuration in XMLSpy; no new file assignments have to be made each time a transformation is required with a different file. When an XSLT transformation is started, it will use the file/s associated with the active configuration.

XSLT transformations and XQuery executions

Clicking the command [XSL/XQuery | XSL Transformation](#)⁹⁰⁷ or [XSL/XQuery | XSL:FO Transformation](#)⁹⁰⁸ or [XSL/XQuery | XQuery Update Execution](#)⁹¹³ pops up a dialog in which you can browse for the required XSLT, XQuery, or XML file. Click the **Browse** button and then the **Global Resource** button to pop up the Open Global Resource dialog ([screenshot at top of section](#)⁷⁰⁸). The file that is associated with the currently active configuration of the selected global resource is used for the transformation.

Assigning an SPS

When assigning a StyleVision stylesheet to an XML file ([Authentic | Assign StyleVision Stylesheet](#)), you can select a global resource to locate the stylesheet. Click the **Browse** button and then the **Switch to Global Resource** button to pop up the Open Global Resource dialog ([screenshot at top of section](#)⁷⁰⁸). With a global resource selected as the assignment, the Authentic View of the XML document can be changed merely by changing the active configuration in XMLSpy.

18.2.2 Assigning Databases

When a command is executed that imports data or a data structure (as an XML Schema) from a DB into XMLSpy (for example, with the [Convert | Import Database Data](#) command), you can select the option to use a global resource (*screenshot below*). Other commands where a database-type global resource can be used are database-related commands in the menu.

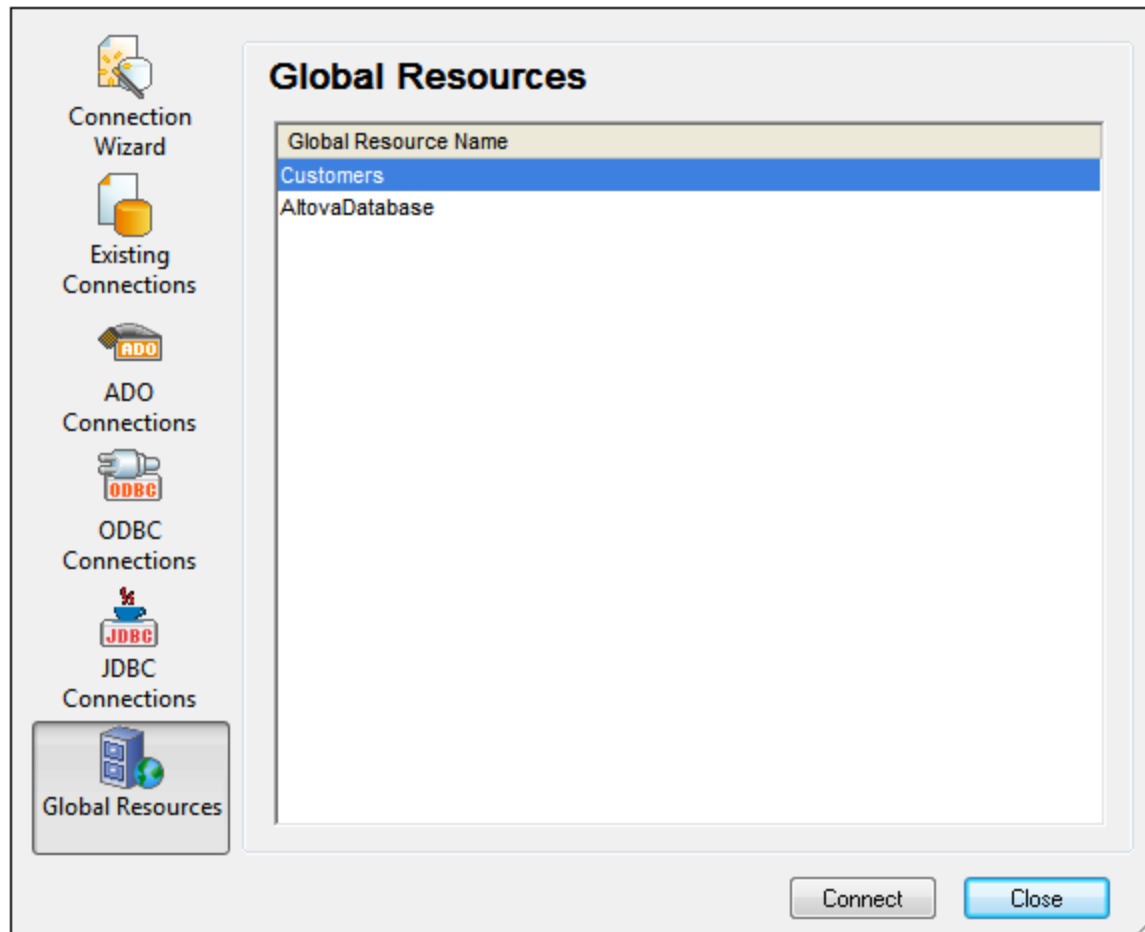

In the Connection dialog (*screenshot above*), all the database-type global resources that have been defined in the currently active [Global Resources XML File](#)⁶⁹⁷ are displayed. Select the required global resource and click **Connect**. If the selected global resource has more than one configuration, then the database resource for the currently active configuration is used (check **Tools | Active Configuration** or the Global Resources toolbar), and the connection is made. You must now select the data structures and data to be used as described in [Creating an XML Schema from a DB](#)⁹⁷⁵ and [Importing DB data](#)⁹⁶⁴.

18.2.3 Changing the Active Configuration

One configuration of a global resource can be active at any time. This configuration is called the active configuration, and it is active application-wide. This means that the active configuration is active for all global resources aliases in all currently open files and data source connections. If an alias does not have a configuration with the name of the active configuration, then the default configuration of that alias will be used. As an example of how to change configurations, consider the case in which a file has been assigned via a global resource with multiple configurations. Each configuration maps to a different file. So, which file is selected depends on which configuration is selected as the application's active configuration.

Switching the active configuration can be done in the following ways:

- Via the menu command **Tools | Active Configuration**. Select the configuration from the command's submenu.
- In the combo box of the Global Resources toolbar (*screenshot below*), select the required configuration.



In this way, by changing the active configuration, you can change source files that are assigned via a global resource.

19 Projects

A project is a collection of files that are related to each other in some way you determine. For example, in the screenshot below, a project named `Examples` collects the files for various examples in separate example folders, each of which can be organized further into sub-folders. Within the `Examples` project, for instance, the `OrgChart` example folder is organized further into sub-folders for XML, XSL, and Schema files.

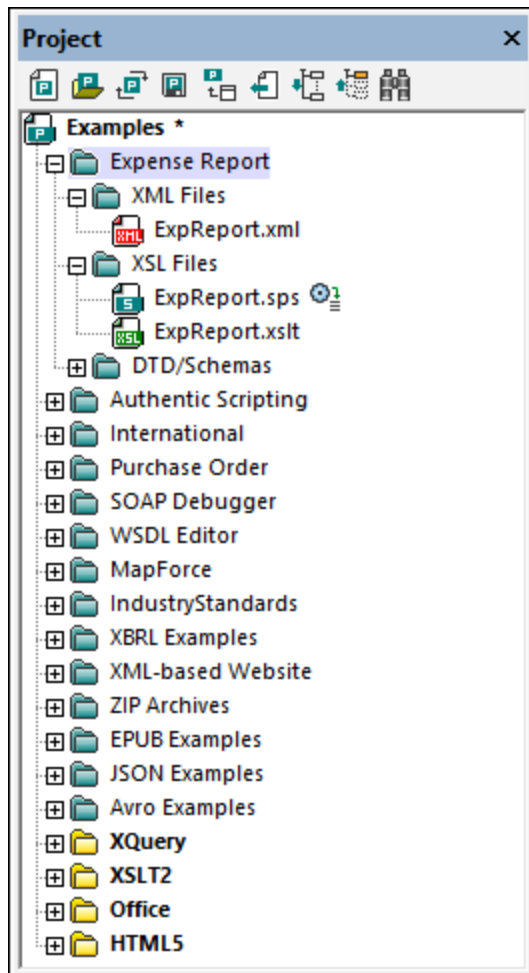

Projects thus enable you to gather together files that are used together and to access them quicker. Additionally, you can define schemas and XSLT files for individual folders, thus enabling the batch processing of files in a folder.

This section describes [how to create and edit projects](#)⁷¹⁵ and [how to use projects](#)⁷¹⁹.

19.1 Creating and Editing Projects

Projects are managed via the [Project Window](#)¹¹⁰ (screenshot below) and the [Project menu](#)⁸²³. One project can be open at a time in the application. The open project is displayed in the [Project Window](#)¹¹⁰.

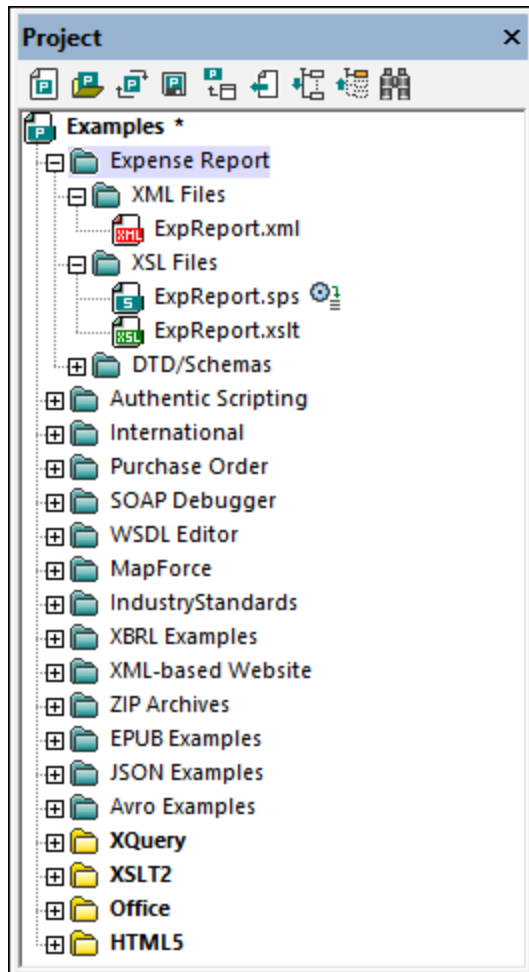

Creating new projects, opening existing projects

A new project is created with the menu command **Project | New Project**. An existing project is opened with the menu command **Project | Open Project**. The newly opened project (whether new or existing) replaces the previously opened project in the Project Window. If the previously opened project contains unsaved changes (indicated by an asterisk next to the folder name; see screenshot below), you are asked whether you wish to save these changes.

Naming and saving projects

A new project is named when you save it. A project is saved with the **Project | Save Project** command and has the `.spp` file extension. After a project has been modified, the project must be saved for the modifications to be stored. Note that a project (indicated by the top-level folder in the Project Window) can only be re-named

by changing its name in Windows File Explorer; the name cannot be changed in the GUI. (The names of sub-folders, however, can be changed in the GUI.)

Project structure

A project has a tree structure of folders and files. Folders and files can be created at any level and to an unlimited depth. Do this by selecting a folder in the Project Window and then using the commands in the **Project** menu or context menu to add folders, files, or resources. Folders, files, and resources that have been added to a project can be deleted or dragged to other locations in the project tree.

When a new project is created, the default project structure organizes the project by file type (XML, XSL, etc) (see screenshot below).

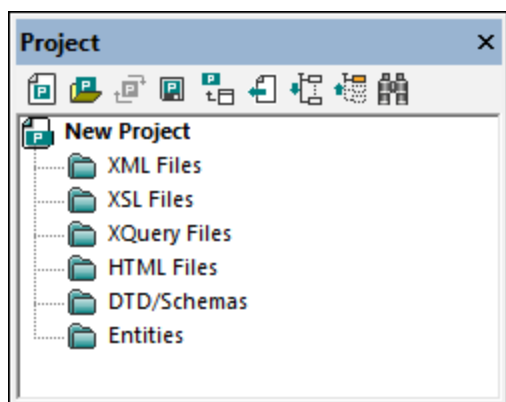

File-type extensions are associated with a folder via the property definitions for that folder. When a file is added to a folder, it is automatically added to the appropriate child folder according to the file-type extension. For each folder, you can define what file-type extensions are to be associated with it.

What can be added to a project

Folder, files, and other resources can be added either to the top-level project folder or to a folder at any level in the project. There are three types of folders: (i) project folders; (ii) external folders; (iii) external web folders.

To add an object, select the relevant folder and then the required command from the **Project** menu or context menu of the selected folder. The following objects are available for addition to a project folder

- *Project folders* (green) are folders that you add to the project in order to structure the project's contents. You can define what file extensions are to be associated with a project folder (in the properties of that folder). When files are added to a folder, they are automatically added to the first child folder that has that file's extension associated with it. Consequently, when multiple files are added to a folder, they will be distributed by file extension among the child folders that have the corresponding file-extension associations.
- *External folders* (yellow) are folders in a file system. When an external folder is added to a folder, the external folder and all its files, sub-folders, and sub-folder files are included in the project. Defining file extensions on an external folder serves to filter the files available in the project.
- *External web folders* are like external folders, except that they are located on a web server and require user authentication to access. Defining file extensions on an external web folder serves to filter the files available in the project.
- *Files* can be added to a folder by selecting the folder and then using one of the three Add-File commands: (i) **Add Files**, to select the file/s via an Open dialog; (ii) **Add Active File**, to add the file

that is active in the Main Window; (iii) **Add Active and Related Files**, additionally adds files related to an active XML file, for example, an XML Schema or DTD. Note that files associated by means of a processing instruction (for example, XSLT files), are not considered to be related files.

- *Global Resources* are aliases for file, folder, and database resources. How they are defined and used is described in the section on [Global Resources](#)⁶⁹⁶.
- *URLs* identify a resource object via a URL.
- *An Altova Scripting Project*, which is a `.asprj` file, can be assigned to an XMLSpy project. This will make macros and other scripts available to the project. How to create a Scripting Project and assign one to an XMLSpy project is described in the section, [Scripting](#)¹⁰⁹².

Project and folder properties

Properties (such as the schema for validation and the XSLT for transformation) can be set not only on the entire project, but also on individual folders. You can then carry out actions, such as validation and transformation, on the entire project or individual folders. To carry out an action, right-click the project or folder, and select the action you want to carry out from the context menu that appears.

The properties of a folder are stored in the Properties dialog of that folder, which is accessed by first selecting the folder and then the menu command **Project | Properties** (or the folder's context menu command Properties). The following properties of a folder can be defined and edited in the Properties dialog:

- *Folder name*: cannot be edited for the top-level project folder (for which, instead of a name, a filepath is displayed).
- *File extensions*: cannot be edited for the top-level project. This is a list of file extensions separated by semi-colons (for example, `xml;svg;wm1`). This list determines what files are added to the folder when files are added to a project. For example, when active and related files are added to a project, then the *File extensions* determine into which folders the added files will be placed.
- *Validation*: specifies the DTD or XML Schema file that should be used to validate XML files in a folder.
- *Transformations*: specifies (i) the XSLT files to be used for transforming XML files in the folder, and (ii) the XML files to be transformed with XSLT files in the folder.
- *Destination files*: for the output of transformations, specifies the file extension and the folder where the files are to be saved.
- *SPS files for Authentic View*: specifies the SPS files to be used so that XML files in a folder can be viewed and edited in Authentic View.

Note the following points:

- A property that is set on a folder overrides the same property that is set on the project.
- If a property is set on the project, it is applied to all folders that do not have the same property set.
- If an action is carried out on a project, it is applied to all applicable file types in all folders of the project. For example, if a validation is carried out on a project, the validation is run on all XML files in all folders of the project. In this case, the schema that has been set for the project is used for all validations, except for XML files that are in folders which have the schema validation property set to some other schema.

See the description of the [Project | Properties](#)⁸⁴⁹ command for more detailed information.

Source control in projects

Source control systems that are compatible with Microsoft Visual Source-Safe are supported in projects. How to use this feature is described in the [User Reference section](#)⁸²⁷ of the manual.

Saving projects

Any changes you make to a project, such as adding or deleting a file, or modifying a project property, must be saved with the **Save Project** command.

Find in project

You can search for project files and folders using their names or a part of their name. If the search is successful, files or folders that are located are highlighted one by one.

To start a search, activate the Project window by clicking it (or in it), then select the command **Edit | Find** (or the shortcut **Ctrl+F**). In the Find dialog that pops up (*screenshot below*) enter the text string you wish to search for and select or deselect the search options (*explained below*) according to your requirements.

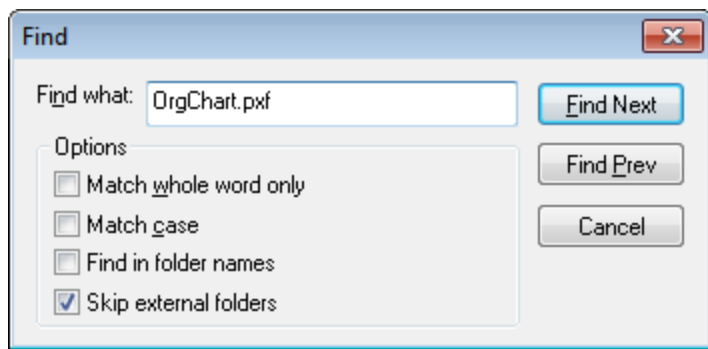

The following search options are available:

- Whole-word matching is more restricted since the entire string must match an entire word in the file or folder name. In file names, the parts before and after the dot (without the dot) are each treated as a word.
- It can be specified that casing in the search string must exactly match the text string in the file or folder name.
- Folder names can be included in the search. Otherwise, only file names are searched.
- [External folders](#)⁸⁴² can be included or excluded from the search. External folders are actual folders on the system or network, as opposed to project folders, which are created within the project and not on the system.

If the search is successful, the first matching item is highlighted in the Project sidebar. You can then browse through all the returned matching items by clicking the **Find Next** and **Find Prev** buttons in the Find dialog.

Refreshing projects

If a change is made to an external folder, this change will not be reflected in the Project Window till the project is refreshed.

19.2 Using Projects

Projects are very useful for organizing your workspace, applying settings to multiple files, and for setting up and executing batch commands. Using projects can therefore greatly help speed up and ease your work. For information about managing projects, see [Creating and Editing Projects](#)⁷¹⁵ and the [description of the Project Window](#)¹¹⁰.

Benefits of using projects

The following list lists the benefits of using projects.

- Files and folders can be grouped into folders by file extension or any other desired criterion.
- Schemas and XSLT files can be assigned to a folder. This can be useful if you wish to quickly validate or transform a single XML file using different schema or XSLT files. Add the XML file to different folders and define different schemas and XSLT files for the different folders.
- Batch processing can be applied to individual folders. The commands available for batch processing are listed below.
- Output folders can be specified for transformations.

Organizing resources for quick access

Folder and file resources can be organized into a tree structure, giving you a clear overview of the various folders and files in your project, and enabling you to quickly access any and all files in a project. Simply double-click a file in the Project window to open it. You can quickly add files and folders to a project as required and delete unwanted files and folders. When you wish to work with another project, close the project currently open in the Project Window and open the required project.

Batch processing

The commands for batch processing of files in a folder, whether the top-level project folder or a folder at any other level, are **available in the context menu of that folder** (obtained by right-clicking the folder). The steps for batch processing are as follows:

1. Define the files to be used for validation or transformation in the Properties dialog of that folder.
2. Specify the folder in which the output of transformations should be saved. If no output folder is specified for a folder, the output folder of the next ancestor folder in the project tree is used.
3. Use the commands in the context menu for batch execution. If you use the corresponding commands in the **XML**, **DTD/Schema**, or **XSL/XQuery** menus, the command will be executed only on the document active in the Main Window, not on any project folder in the Project Window.

The following commands in the context menu of a project folder (top-level or other) are available for batch processing:

- *Well-formed check*: If any error is detected during the batch execution, it is reported in the Messages Window.
- *Validation*: If any error is detected during the batch execution, it is reported in the Messages Window.
- *Transformations*: Transformation outputs are saved to the folder specified as the output folder in the Properties dialog of that folder. If no folder is specified, the output folder of the next ancestor project folder is used. If no ancestor project folder has an output folder defined, a document window is opened and the results of each transformation is displayed successively in this document window. An XSL-FO transformation transforms an XML document or FO document to PDF.

- *Generate DTD / XML Schema*: Before the schemas are generated, you are prompted to specify an output folder. The generated schema files are saved to this folder and displayed in separate windows in the GUI.

Note: To execute batch commands use the context menu of the relevant folder in the Project Window. Do not use the commands in the XML, DTD/Schema, or XSL/XQuery menus. These commands will be executed on the document active in the Main Window.

Validation and XSLT/XQuery with RaptorXML Server

Context menu commands on project folder enable you to use RaptorXML Server for high-performance XML validation and XSLT/XQuery transformations. See the section [RaptorXML Server](#)⁷²¹ for more information.

20 RaptorXML(+XBRL) Server

If Altova RaptorXML(+XBRL) Server (hereafter also called RaptorXML Server, RaptorXML, or Raptor for short) is installed and licensed on your network and if your XMLSpy installation has access to it, then you can use RaptorXML Server to validate XML and XBRL* documents, as well as run [XSLT and XQuery transformations](#)⁷³⁶. You can validate the active document or all the documents in an XMLSpy project folder. The validation results are displayed in the Messages window of the GUI.

In XMLSpy, you can (i) validate documents, (ii) run XSLT/XQuery transformations, or (iii) execute XJLE documents (or document sets) on an XBRL instance. One of the main advantages of using Raptor is that you can configure individual validations or executions by means of a large range of validation options. Furthermore, you can store a set of Raptor options as a "configuration" in XMLSpy, and then select one of your defined configurations for a particular Raptor validation. Using Raptor is also advantageous when large data collections are to be validated.

Note: The actual performance depends on the number of PC processor cores used by RaptorXML Server for the validation: The higher the number of cores used, the faster will be the processing.

***Note:** There are two editions of Raptor: *RaptorXML Server* (for XML validations) and *RaptorXML+XBRL Server* (for XML and XBRL validations). If you wish to validate XBRL documents, you must use RaptorXML+XBRL Server. For more information about RaptorXML(+XBRL) Server, please see the [Altova website](#) and the user manuals: [RaptorXML Server](#) and [RaptorXML+XBRL Server](#).

Note: RaptorXML Server cannot be used with HTTP proxies because these do not support websocket upgrades. If you encounter this problem, add the RaptorXML Server host to the proxy-ignore list.

How to validate or transform using RaptorXML Server

To validate an XML or XBRL document using RaptorXML Server, or to run an XSLT or XQuery transformation, XMLSpy must know which RaptorXML Server to use, how to access this server, and what options to pass to Raptor for the validation. This information is managed in XMLSpy as follows:

1. [By adding a server to the pool of Raptor servers](#)⁷²². In this step, RaptorXML Servers are added to a pool, and the access information of each server is stored in XMLSpy. Each server is identified by a name.
2. [By defining configurations for each server](#)⁷²³. A configuration is a set of Raptor validation options. Each server can have multiple configurations. For a validation, you select one configuration, which becomes the active configuration.
3. [Selecting a server configuration with which to validate](#)⁷²⁶. A server and one of its configurations is selected to be the active configuration. The active configuration is used for all subsequent validations that use Raptor.
4. [Validate](#)⁷²⁶ or [run the XSLT/XQuery transformation](#)⁷³⁶ with Raptor.

20.1 Adding Servers and Server Configurations

In the RaptorXML Server Options dialog (screenshot below, [Tools | Manage Raptor Servers](#)¹⁰¹⁹), you can [add multiple Raptor Servers](#)⁷²² to the pool of available Raptor Servers and then [define multiple configurations](#)⁷²³ for each server. The added servers, together with the configurations you define for each of them, will appear in the [Tools | Raptor Servers and Configurations](#)¹⁰²² submenu. In this submenu, you can select the server configuration you want to use for a Raptor validation.

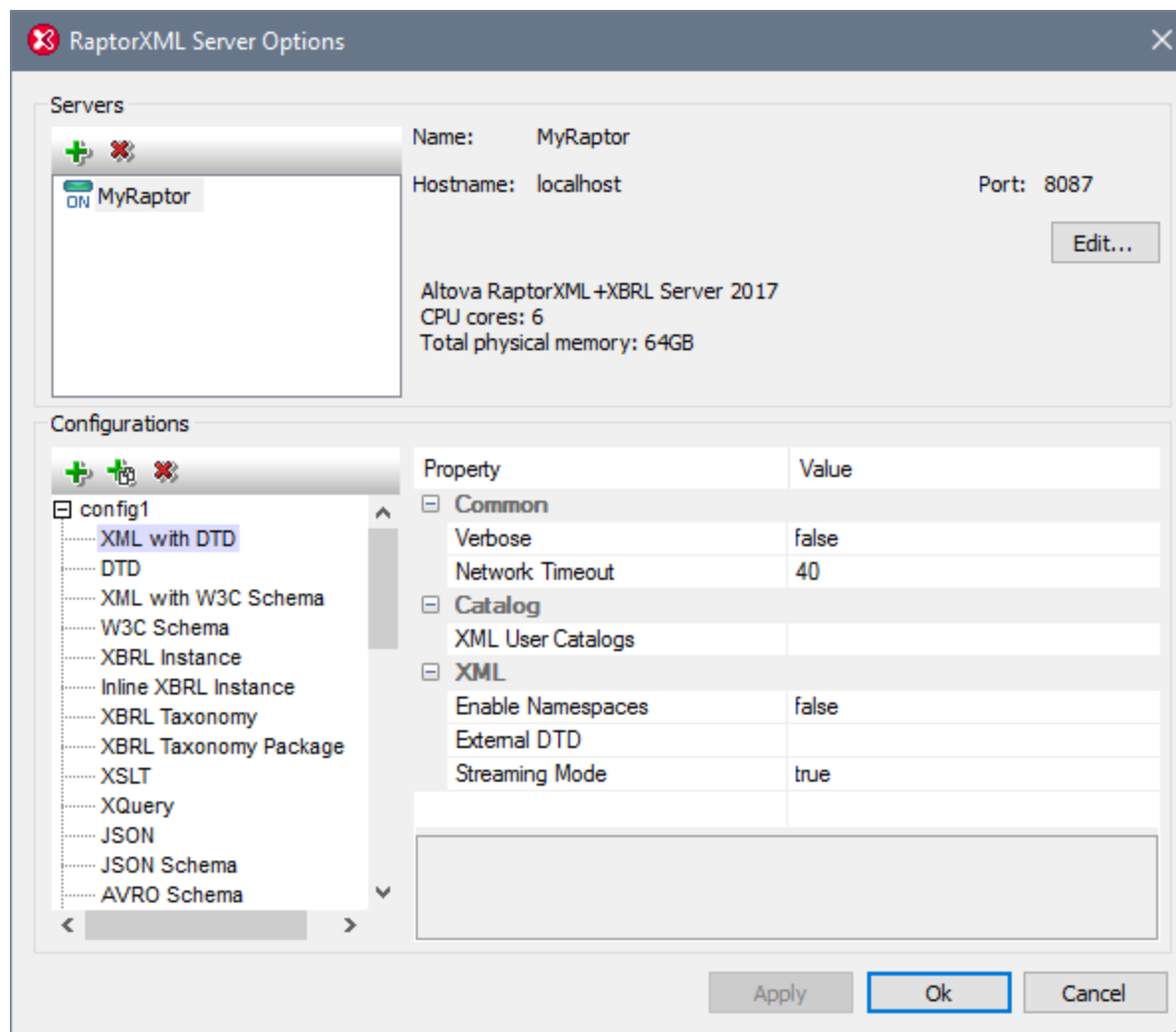

Adding a Raptor Server

In the dialog's *Servers* pane (screenshot below), click the **Add Server** icon, then enter the name by which you wish to identify the Raptor server, the network name of the machine on which Raptor is installed (host name), and the port of the Raptor Server. Click **OK** to save the settings.

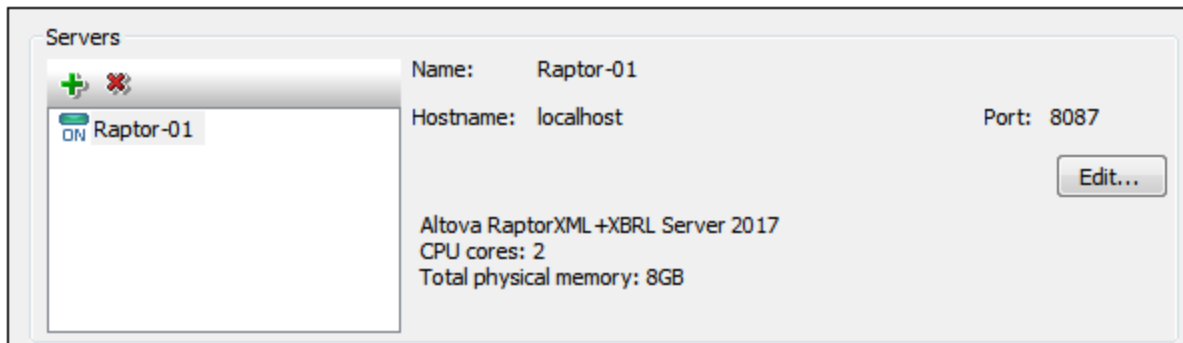

- **Name:** Any string you choose. It is used in XMLSpy to identify a particular RaptorXML Server.
- **Host name:** The name or IP address of the network machine on which the Raptor server is installed. Processing will be faster if you use an IP address rather than a host name. The IP address corresponding to `localhost` (the local machine) is `127.0.0.1`.
- **Port:** The port via which the Raptor server is accessed. This port is specified in Raptor's configuration file (called `server_config.xml`). The port must be fixed and known so that requests can be correctly addressed to the service. For more information about the Raptor configuration file, see the user manuals: [RaptorXML Server](#) and [RaptorXML+XBRL Server](#).

After entering the server information, click **OK**. The server name you entered appears in the server list (in the left of the pane). A green icon appears next to the server's name, indicating that the Raptor server has been started and is running. The details of the server are displayed in the pane (see *screenshot above*). A red icon indicates that the server is offline. If the server cannot be found, an error message is displayed.

Note: The Raptor server must be running when the server is added. This is necessary so that XMLSpy can obtain information about the server and store it. If, after the server has been added, the server is offline or cannot be found, then these situations are indicated, respectively, by a red icon or an error message.

To edit a server's name, host name, or port, select the server in the left-hand pane, click the **Edit** button, and, in the dialog that appears, edit the information you want to change. To remove a server from the pool, select the server and click the **Remove Selected Server** icon.

Server Configurations

A configuration is a set of RaptorXML validation options. When a server is added, it will have a configuration named `default`. This is a set of RaptorXML options set to their default values. You can add new configurations that contain other option values. After you have defined multiple server configurations, you can select one configuration to be the active configuration. This is the configuration that will be used when the **Validate on Server** command is executed.

The *Configurations* pane has two parts: (i) a left-hand pane, which shows the configurations, each containing a list of document-types that can be validated; (ii) a right-hand pane, which displays the validation options for the document-type selected in the left-hand pane; at the bottom of the right-hand pane is a description of the selected option (see *screenshot above*).

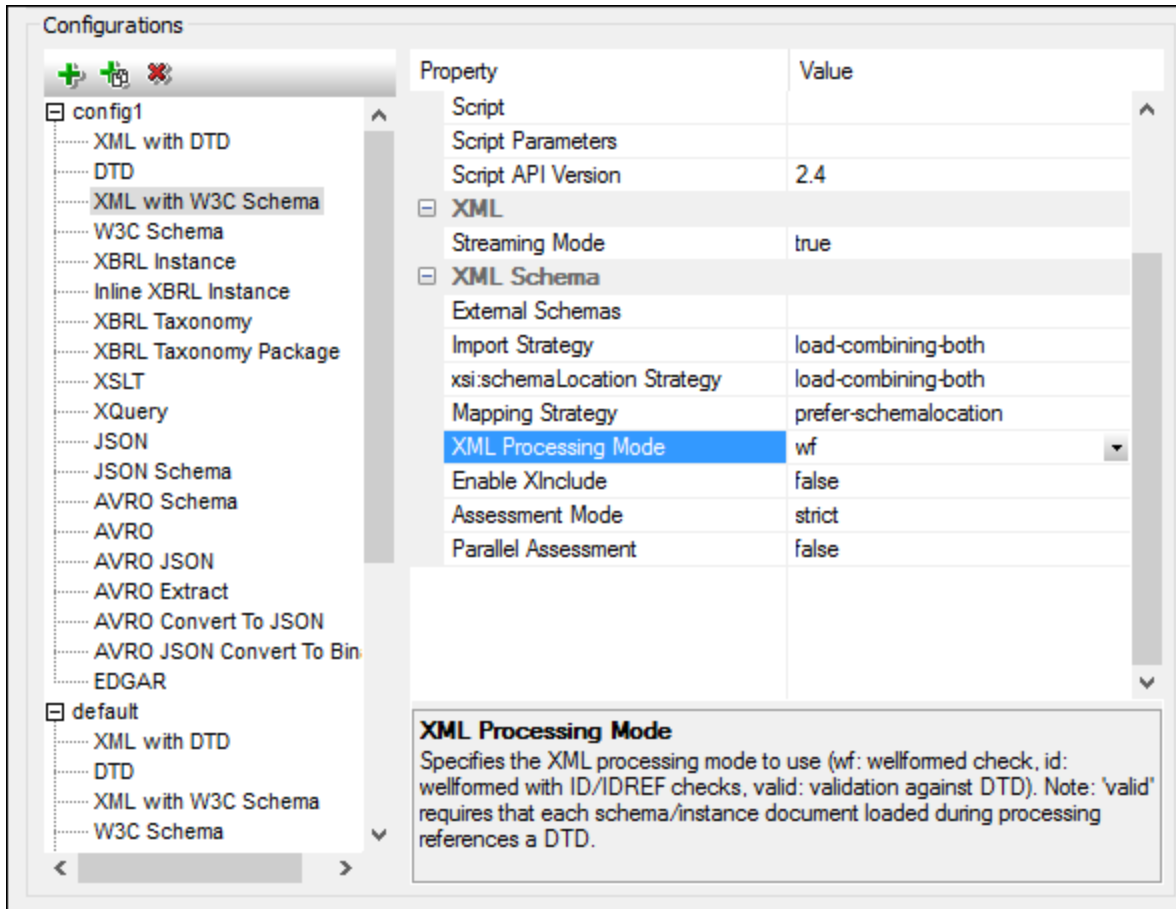

Adding a configuration

In the *Configurations* pane of the RaptorXML Server Options dialog (*screenshot above*), click **Add a Configuration**. A new configuration is added with default option values. You can also create a new configuration by clicking **Copy Selected Configuration**. This creates a new configuration with option values that are the same as that of the copied configuration. New configurations are created with default names of the type `config<X>`; you can edit the name of a configuration by double-clicking it and entering the new name. You can then edit any of the configuration's option values.

Editing a configuration's option values

First, select the document-type in the left-hand pane. This displays the validation options of the selected document-type in the right-hand pane. To edit the value of an option, do one of the following (depending on the type of option value):

- If the value can be one of a set of predefined values, select the value you want from the combo box of that option's value column.
- If the value is not constrained, click in the option's value field and enter the value you want.
- If the value is a file path, in addition to being able to enter the value, you can also browse for the file you want by using the **Browse** button in the option's value column.

If you select an option, its description is displayed in a box at the bottom of the right-hand pane. For more

detailed descriptions of each option, see the command line interface chapters of the [RaptorXML Server](#) and [RaptorXML\(+XBRL\) Server](#) user manuals.

Removing a configuration

In the left-hand pane, select the configuration to be removed and click **Remove Selected Configuration**.

XMLSpy in Visual Studio and Eclipse

When XMLSpy is integrated in [Visual Studio](#)⁷⁶⁷ and [Eclipse](#)⁷⁷², the active configuration in these IDEs will be the one that is currently set as the active configuration in the standalone version of XMLSpy.

20.2 Validating with RaptorXML Server

You can validate XML and XBRL* documents with RaptorXML Server. Validating involves two steps:

- Selecting the server and server configuration to use for the validation
- Running the validation (by using one of the **Validate on Server** commands; see *below*)

***Note:** There are two editions of Raptor: *RaptorXML Server* (for XML validations) and *RaptorXML+XBRL Server* (for XML and XBRL validations). If you wish to validate XBRL documents, you must use RaptorXML+XBRL Server. For more information about RaptorXML(+XBRL) Server, please see the [Altova website](#) and the user manuals: [RaptorXML Server](#) and [RaptorXML+XBRL Server](#).

Selecting the server configuration to use

If you have defined multiple configurations on multiple servers, you can select a server and one of its configurations as the active configuration. The active configuration will be used for subsequent validations. On placing the cursor over the **Tools | Raptor Servers and Configurations** command (see *screenshot below*), a submenu appears that contains all the added servers, together with the configuration of each. Select the server configuration you want to make the active configuration. In the screenshot below, the `xbrl` configuration of the server named `Raptor-01` has been selected as the active configuration (indicated by the green arrow).

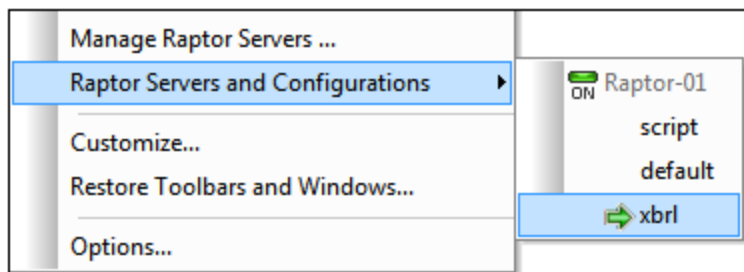

Validating with RaptorXML Server

You can validate XML and XBRL documents by using the validation engines of XMLSpy or by using RaptorXML Server. To validate using RaptorXML Server, do one of the following:

- Click the toolbar icon **Validate on Server**
- Select the command **XML | Validate XML on Server (high-performance) (Ctrl+F8)**
- In the Project entry helper, right-click the project, a folder, or a file, and select **Validate XML on Server (high performance)** to validate XML or XBRL data in the selected object.

Note: Raptor validation is available in Text View, Schema View,, and Grid View.

20.3 Validation Options

This section is organized by the type of document being validated (see the left-hand pane of the screenshot below). For example, *XML with W3C Schema* validates an XML document against a W3C XML Schema. When a validation type is selected in the left-hand pane, the RaptorXML Server validation options available for that kind of validation are displayed in the right-hand pane. These options are organized into groups, such as *Scripting* and *XML Schema* (see *screenshot below*). Note that not all groups shown in the screenshot (such as the XBRL groups) are available in Professional Edition.

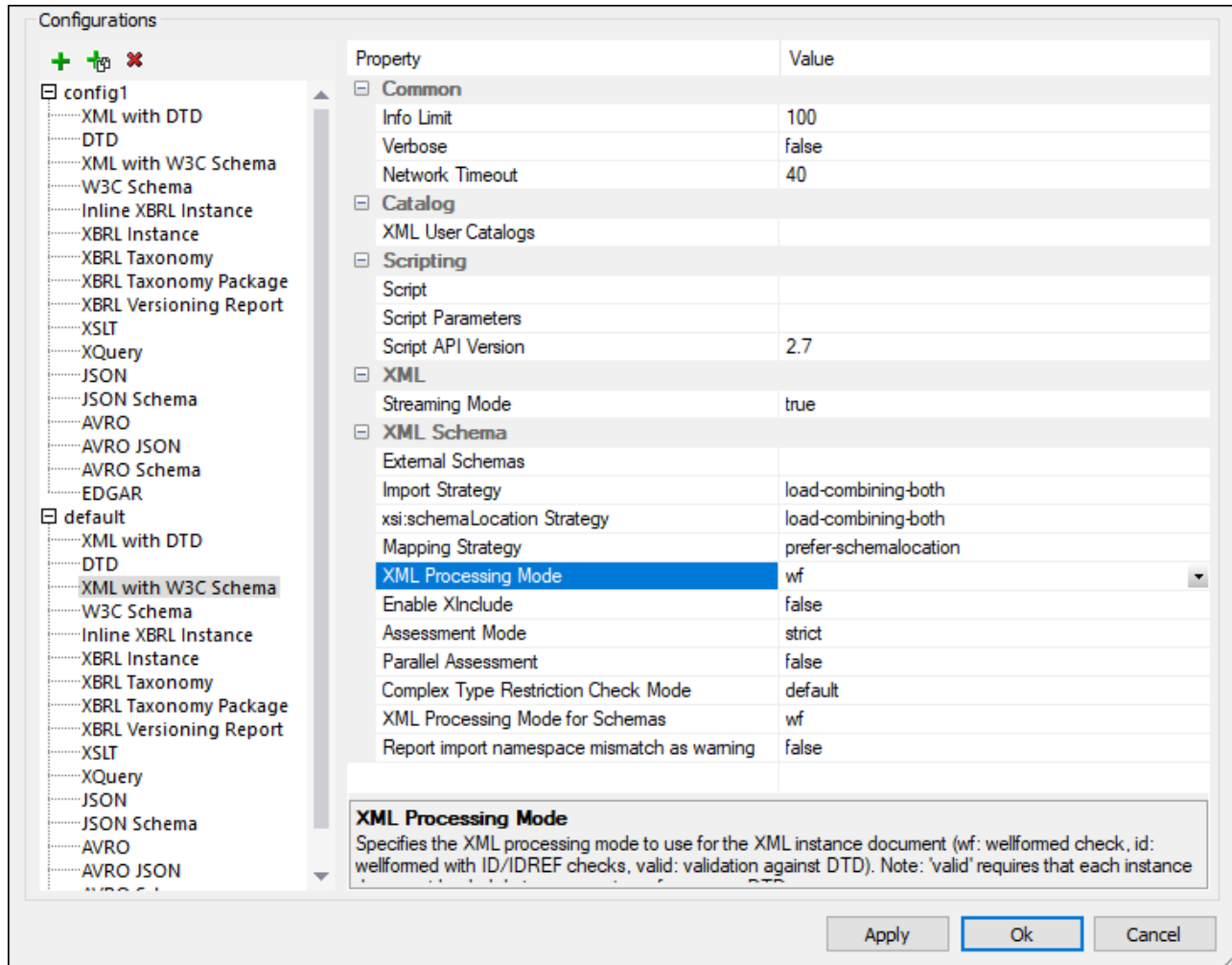

The sub-sections of this section contain links to the descriptions of the respective RaptorXML Server validation options.

20.3.1 Common Options

Options that are common to all types of validation.

- [-] Common
 - [Info Limit](#)
 - [Verbose](#)
 - [Network Timeout](#)

- [-] Catalog
 - [XML User Catalog](#)

20.3.2 XML with DTD

Options for validating XML data against a DTD.

- [-] Common
 - [Info Limit](#)
 - [Verbose](#)
 - [Network Timeout](#)
- [-] Catalog
 - [XML User Catalog](#)
- [-] XML
 - [Enable Namespaces](#)
 - [External DTD](#)
 - [Streaming Mode](#)

20.3.3 DTD

Options for validating DTDs.

- [-] Common
 - [Info Limit](#)
 - [Verbose](#)
 - [Network Timeout](#)
- [-] Catalog
 - [XML User Catalog](#)

- [-] Scripting

- [Script](#)

- [Script Parameters](#)

- [Script API Version](#)

20.3.4 XML with W3C Schema

Options for validating XML data against XML Schema.

- [-] Common

- [Info Limit](#)

- [Verbose](#)

- [Network Timeout](#)

- [-] Catalog

- [XML User Catalog](#)

- [-] Scripting

- [Script](#)

- [Script Parameters](#)

- [Script API Version](#)

- [-] XML

- [Streaming Mode](#)

- [-] XML Schema

- [External Schemas \(xsd\)](#)

- [Import Strategy \(schema-imports\)](#)

- [xsi:schemaLocation Strategy \(schemalocation-hints\)](#)

- [Mapping Strategy \(schema-mapping\)](#)

- [XML Processing Mode \(xml-mode\)](#)

- [Enable Xinclude \(xinclude\)](#)

- [Assessment Mode](#)

- [Parallel Assessment](#)

- [Complex Type Restriction Check Mode](#)

- [XML Processing Mode for Schemas](#)

- [Report Import Namespace Mismatch as Warning](#)

20.3.5 W3C Schema

Options for validating XML Schemas.

☐ Common

[Info Limit](#)

[Verbose](#)

[Network Timeout](#)

☐ Catalog

[XML User Catalog](#)

☐ Scripting

[Script](#)

[Script Parameters](#)

[Script API Version](#)

☐ XML Schema

[Import Strategy \(schema-imports\)](#)

[xsi:schemaLocation Strategy \(schemalocation-hints\)](#)

[Mapping Strategy \(schema-mapping\)](#)

[Enable XInclude \(xinclude\)](#)

[Complex Type Restriction Check Mode](#)

[XML Processing Mode for Schemas](#)

[Report Import Namespace Mismatch as Warning](#)

20.3.6 XSLT

Options for validating XSLT documents.

☐ Common

[Info Limit](#)

[Verbose](#)

[Network Timeout](#)

☐ Catalog

[XML User Catalog](#)

- [-] XML Schema
 - [Import Strategy \(schema-imports\)](#)
 - [xsi:schemaLocation Strategy \(schemalocation-hints\)](#)
 - [Mapping Strategy \(schema-mapping\)](#)
 - [XML Processing Mode \(xml-mode\)](#)
 - [Enable XInclude \(xinclude\)](#)

- [-] Java Extension
 - [Disable Java Extensions \(javaext-disable\)](#)
 - [Barcode Extension Location \(javaext-barcode-location\)](#)

- [-] Chart Extensions
 - [Disable Chart Extensions \(chartext-disable\)](#)

- [-] .NET Extensions
 - [Disable .NET Extensions \(dotnetext-disable\)](#)

- [-] XEngines Common
 - [Load XML with PSVI \(load-xml-with-psvi\)](#)

- [-] XSLT
 - [XSLT Engine Version \(xslt-version\)](#)
 - [Template Mode](#)
 - [Template Entry Point](#)

20.3.7 XQuery

Options for validating XQuery documents.

- [-] Common
 - [Info Limit](#)
 - [Verbose](#)
 - [Network Timeout](#)

- [-] Catalog
 - [XML User Catalog](#)

- [-] XML Schema
 - [Import Strategy \(schema-imports\)](#)
 - [xsi:schemaLocation Strategy \(schemalocation-hints\)](#)
 - [Mapping Strategy \(schema-mapping\)](#)
 - [XML Processing Mode \(xml-mode\)](#)
 - [Enable XInclude \(xinclude\)](#)

- [-] Java Extension
 - [Disable Java Extensions \(javaext-disable\)](#)
 - [Barcode Extension Location \(javaext-barcode-location\)](#)

- [-] Chart Extensions
 - [Disable Chart Extensions \(chartext-disable\)](#)

- [-] .NET Extensions
 - [Disable .NET Extensions \(dotnetext-disable\)](#)

- [-] XEngines Common
 - [Load XML with PSVI \(load-xml-with-psvi\)](#)

- [-] XQuery
 - [XQuery Engine Version \(xquery-version\)](#)
 - [Omit XML Declaration](#)

20.3.8 JSON

Options for validating JSON (instance) documents.

- [-] Common
 - [Info Limit](#)
 - [Verbose](#)
 - [Network Timeout](#)

- [-] Catalog
 - [XML User Catalog](#)

- ☐ JSON validation

- [Disable Format Checks](#)

- [JSON Lines](#)

- [JSON with Comments](#)

20.3.9 JSON Schema

Options for validating JSON Schema documents.

- ☐ Common

- [Info Limit](#)

- [Verbose](#)

- [Network Timeout](#)

- ☐ Catalog

- [XML User Catalog](#)

- ☐ JSON validation

- [Disable Format Checks](#)

20.3.10 EDGAR

EDGAR (Electronic Data Gathering, Analysis, and Retrieval) is a system that performs automated collection, validation, and indexing of financial statements filed by companies to the United States SEC (Securities and Exchange Commission). When you validate via EDGAR, Raptor validates the XBRL instance document using an internal EDGAR script. You can set the following additional options.

- ☐ EDGAR Script Parameters

The EDGAR script performs extra checks as prescribed in the [EDGAR Filing Manual Volume II: EDGAR Filing](#). The script allows the following script parameters to be additionally specified:

| | |
|--------------------|---|
| CIK | The CIK of the registrant |
| submissionType | The EDGAR submission type, for example: '10-K' |
| cikList | A list of CIKs, each separated by a comma: ', ' |
| cikNameList | A list of official registrant names for each CIK in <code>cikList</code> , separated by '
Edgar ' |
| forceUtrValidation | Set to <code>true</code> to force-enable UTR validation |

| | |
|----------------------|--|
| edbody-url | The path to the edbody.dtd that is used to validate embedded HTML fragments |
| edgar-taxonomies-url | The path to the edgartaxonomies.xml, which contains a list of taxonomy files that are allowed to be referenced from the company extension taxonomy |

[-] Common

[Info Limit](#)

[Verbose](#)

[Network Timeout](#)

[-] Catalog

[XML User Catalog](#)

[-] XML Schema

[Import Strategy \(schema-imports\)](#)

[xsi:schemaLocation Strategy \(schemalocation-hints\)](#)

[Mapping Strategy \(schema-mapping\)](#)

[Enable XInclude \(xinclude\)](#)

[Parallel Assessment](#)

[Complex Type Restriction Check Mode](#)

[Report Import Namespace Mismatch as Warning](#)

[-] XBRL

[Enable Dimensions Extension \(dimensions\)](#)

[Enable Extensible Enumerations Extension \(extensible-enumerations\)](#)

[Preload XBRL Spec Schemas \(preload-xbrl-schemas\)](#)

[Taxonomy Packages](#)

[Taxonomy Packages Config File](#)

[Treat XBRL Inconsistencies as Errors \(treat-inconsistencies-as-errors\)](#)

[UTR File](#)

[Supported UTR Status](#)

[Additional DTS Entry Point](#)

[URI Transformation Strategy \(in Output Documents\)](#)

[Report Summation-Item Inconsistencies](#)

[Report Essence-Alias Inconsistencies](#)

[Report Requires-Element Inconsistencies](#)

[Enable Generic Preferred Label Extension](#)

[Enable Generic Links Extension](#)

[De-duplicate](#)

[Report Duplicates](#)

[Report Duplicates Severity](#)

[-] XBRL Formula

- [Enable Formula Extension \(formula\)](#)
- [Enable Assertion Severity Extension \(assertion-severity\)](#)
- [Preload Formula Spec Schemas \(preload-formula-schemas\)](#)
- [Report Unsatisfied Assertion Evaluations](#)
- [Validation Message Language \(message-lang\)](#)
- [Validation Message Role \(message-role\)](#)
- [Formulas-to-Ignore File](#)
- [Formulas-to-Process File](#)
- [Assertions-to-Ignore File](#)
- [Assertions-to-Process File](#)
- [Formulas-to-Ignore](#)
- [Assertions-to-Ignore](#)
- [Validate Formula Output](#)
- [Enable Formula Optimizations](#)

☐ XBRL Table

- [Enable Table Extension \(table\)](#)
- [Preload Table Spec Schemas \(preload-table-schemas\)](#)
- [Table Linkbase Namespace](#)
- [Table AspectNode Order](#)

☐ XBRL XULE

- [XULE](#)
- [XULE Stack Size](#)
- [XULE Instance Namespace Bindings](#)
- [XULE Rules to Process](#)
- [Report XULE Rule Evaluations](#)
- [XULE Output File](#)

20.4 XSLT and XQuery with RaptorXML Server

You can use RaptorXML Server to run (i) XSLT transformations, (ii) and XQuery updates or executions on XML documents. These actions are available only via [Projects](#)⁷¹⁴, and involve three steps:

- Selecting the server and server configuration to use for the job.
- Setting up the [project folder](#)⁷¹⁵, and specifying the XSLT/XQuery files to use (in the [Project Properties dialog](#)⁷¹⁵). The XSLT/XQuery files that are assigned in the [Project Properties dialog](#)⁷¹⁵ of a folder are the files that will be used for XSLT and XQuery transformations of all XML files in that project folder. You cannot assign XSLT/XQuery files for individual XML files in a project folder; XSLT/XQuery files can only be assigned for an entire folder.
- Running the XSLT transformation or XQuery update/execution.

Note: If the XSLT or XQuery document uses Java extension functions or .NET extension functions, then file paths are used to locate JAR files (Java) or external (unregistered) assembly files (.NET). This means that, if the same XSLT/XQuery document is used for transformations/executions via XMLSpy as well as RaptorXML Server, then file paths in it to JAR files and/or assembly files must correctly locate these files.

Note: If RaptorXML Server is on the same machine as XMLSpy, you should, for best performance, specify that the server setting `server.unrestricted-filesystem-access` has a value of `true`. For more information, see the [documentation of the RaptorXML Server configuration file](#).

Selecting the server configuration to use

If you have defined multiple configurations on multiple servers, you can select a server and one of its configurations as the active configuration. The active configuration will be used for subsequent validations. On placing the cursor over the **Tools | Raptor Servers and Configurations** command (see *screenshot below*), a submenu appears that contains all the added servers, together with the configuration of each. Select the server configuration you want to make the active configuration. In the screenshot below, the `xbrl` configuration of the server named `Raptor-01` has been selected as the active configuration (indicated by the green arrow).

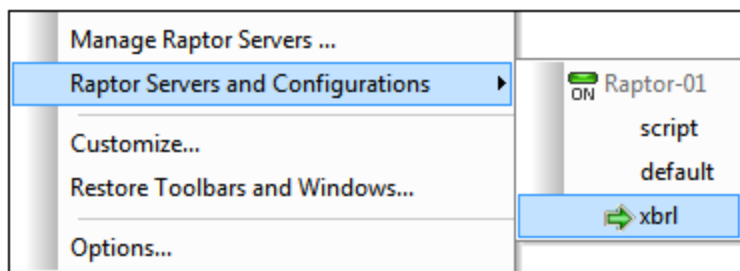

Running an XSLT transformation

You can carry out an XSLT transformation by using the XSLT engines of XMLSpy or by using RaptorXML Server. To run XSLT transformations using RaptorXML Server, do the following:

- Right-click the project folder where the XML files to transform are located. This folder can be the entire project folder or an individual folder anywhere in the project hierarchy

- In the menu that appears, select the command **XSL Transformation on Server (high-performance)**

Note: You cannot assign XSLT/XQuery files for individual XML files in a project folder; XSLT/XQuery files can only be assigned for an entire folder. See [start of section 736](#).

For more related information, see the sections [XSLT 362](#) and [XSLT Transformation 907](#).

Running an XQuery update/execution

You can carry out an XQuery update/transformation by using the XQuery engines of XMLSpy or by using RaptorXML Server. To run XQuery updates/transformation using RaptorXML Server, do the following:

- Right-click the project folder where the XQuery or XML files to, respectively, update or execute are located. This folder can be the entire project folder or an individual folder anywhere in the project hierarchy
- In the menu that appears, select the command **XQuery/Update Execution on Server (high-performance)**

Note: You cannot assign XSLT/XQuery files for individual XML files in a project folder; XSLT/XQuery files can only be assigned for an entire folder. See [start of section 736](#).

For more related information, see the sections [XQuery 374](#) and [XQuery/Update Execution 913](#).

21 File/Directory Comparisons

XMLSpy provides a File Comparison feature and a Directory Comparison feature that are linked to each other. File Comparisons and Directory Comparisons are started with the **Compare Open File With** and **Compare Directories** commands in the **Tools** menu, respectively. Comparison options for file comparisons can be defined in the Settings dialog, which is accessed by clicking the **Compare Options** command in the **Tools** menu.

Each of these commands is described in detail in the [User Reference](#)¹⁰⁰⁸ section. In the sub-sections of this section we provide an overview of the [File Comparisons](#)⁷³⁹ and [Directory Comparisons](#)⁷⁴⁰ mechanisms.

21.1 File Comparisons

The [File Comparisons feature](#)¹⁰⁰⁸ enables you to compare the active file with another file, which is selected via an Open File dialog or via a [global resource](#)⁶⁹⁶. The following points provide an overview of the mechanism. For details, see the [User Reference](#)¹⁰⁰⁸ section.

- The settings current in the [Compare Options](#)¹⁰¹⁵ dialog when a File Compare session is started are the settings that will be active for that session.
- You can choose to compare the files as XML files (where document structure is also evaluated) or as Text files. This choice is made by selecting, in the [Settings dialog](#)¹⁰¹⁵, either (i) Grid View or Text View (Textual Comparison Only unchecked) for XML comparisons, or (ii) Text View (Textual Comparison Only checked) for text comparisons.
- The two files appear in adjacent panes in the selected view (Grid View or Text View) and the differences are highlighted in both files (*screenshot below*).

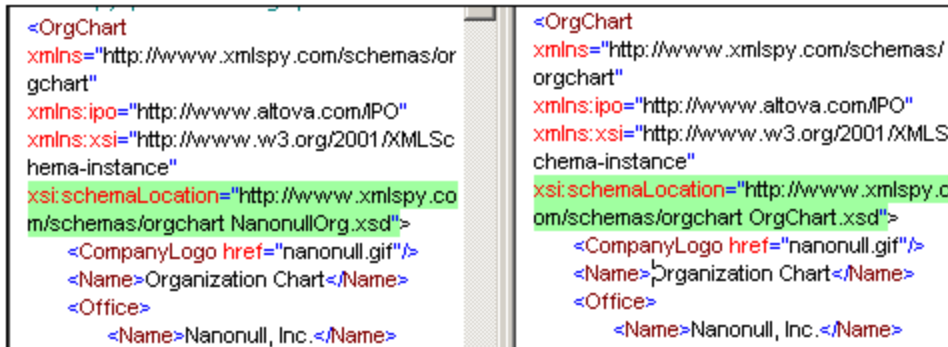

```
<OrgChart
xmlns="http://www.xmlspy.com/schemas/orgchart"
xmlns:ipo="http://www.altova.com/IPO"
xmlns:xsi="http://www.w3.org/2001/XMLSchema-instance"
xsi:schemaLocation="http://www.xmlspy.com/schemas/orgchart NanonullOrg.xsd">
  <CompanyLogo href="nanonull.gif"/>
  <Name>Organization Chart</Name>
  <Office>
    <Name>Nanonull, Inc.</Name>
  </Office>
</OrgChart>
```

```
<OrgChart
xmlns="http://www.xmlspy.com/schemas/orgchart"
xmlns:ipo="http://www.altova.com/IPO"
xmlns:xsi="http://www.w3.org/2001/XMLSchema-instance"
xsi:schemaLocation="http://www.xmlspy.com/schemas/orgchart OrgChart.xsd">
  <CompanyLogo href="nanonull.gif"/>
  <Name>Organization Chart</Name>
  <Office>
    <Name>Nanonull, Inc.</Name>
  </Office>
</OrgChart>
```

A Compare Files control window also pops up which enables you to navigate through the differences and to merge them.

The [Settings dialog](#)¹⁰¹⁵ offers several options for specifying what aspects of the XML documents should be considered for the comparison, and what aspects ignored. For more details, see the [Compare Options](#)¹⁰¹⁵ section in the [User Reference](#)¹⁰⁰⁸.

21.2 Directory Comparisons

The [Directory Comparisons feature](#)⁽¹⁰¹²⁾ enables you to compare directories, each of which you select via separate Browse for Folder dialogs. You can also select whether sub-directories are to be compared or not, and what file types should be considered for the directory comparison.

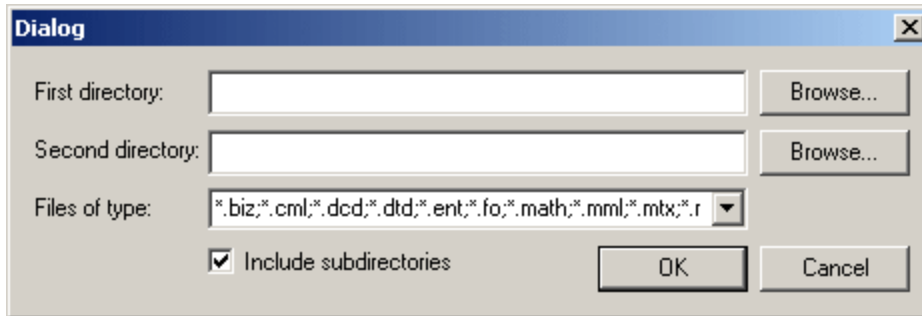

Directories are compared to indicate missing files and whether files of the same name are different or not. The comparisons between files are based on the settings in the [Settings dialog](#)⁽¹⁰¹⁵⁾. The results of the directory comparison are displayed in a separate window (*screenshot below*).

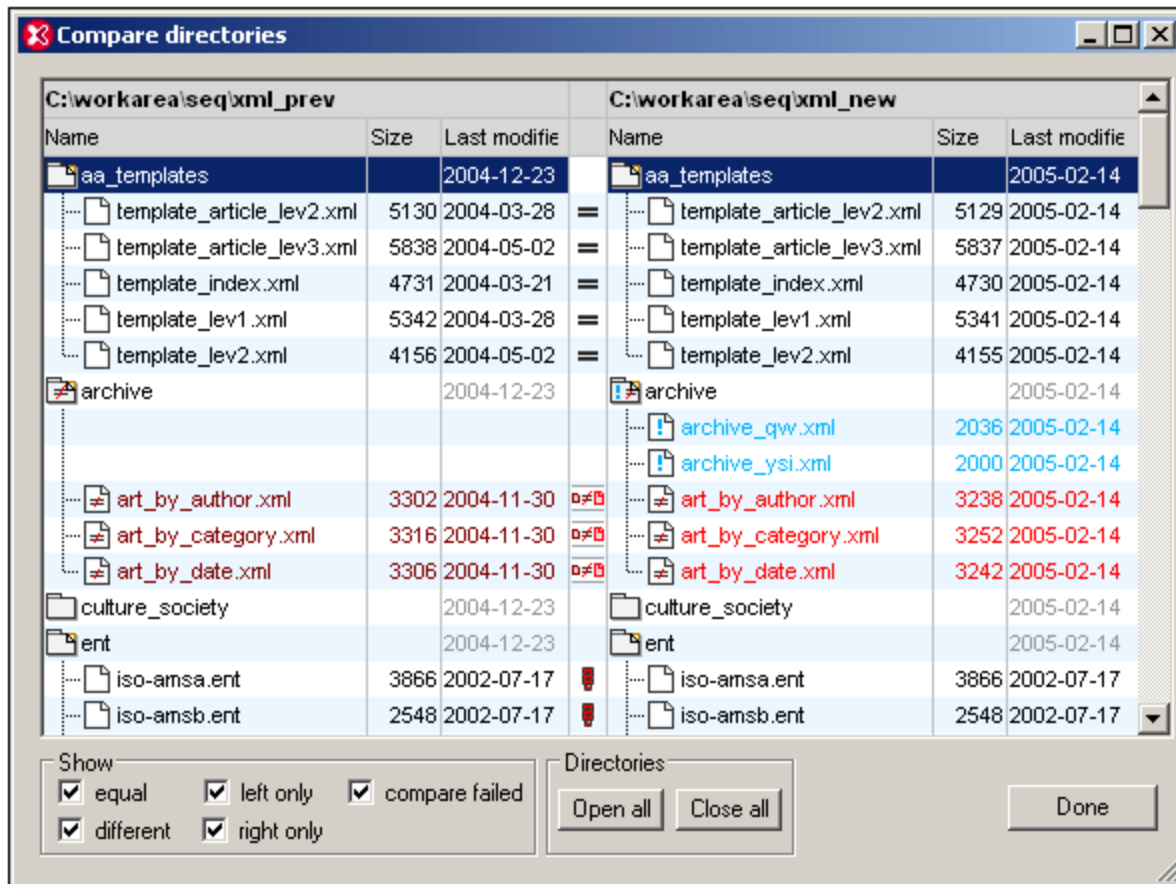

For details about how to read the symbols and manage the view in the Compare Directories window, see the description of the **Compare Directories** command in the [User Reference](#)¹⁰⁰⁸. You can then double-click a file row to directly start a file comparison.

22 Source Control

The source control support in XMLSpy is available through the Microsoft Source Control Plug-in API (formerly known as the MSSCCI API), versions 1.1, 1.2 and 1.3. This enables you to run source control commands such as "Check in" or "Check out" directly from XMLSpy to virtually any source control system that lets native or third-party clients connect to it through the Microsoft Source Control Plug-in API.

You can use as your source control provider any commercial or non-commercial plug-in that supports the Microsoft Source Control Plug-in API, and can connect to a compatible version control system. For the list of source control systems and plug-ins tested by Altova, see [Supported Source Control Systems](#)⁷⁴⁵.

Installing and configuring the source control provider

To view the source control providers available on your system, do the following:

1. On the **Tools** menu, click **Options**.
2. Click the **Source Control** tab.

Any source control plug-ins compatible with the Microsoft Source Code Control Plug-in API are displayed in the **Current source control plug-in** drop-down list.

Current source control plug-in:
 Microsoft Visual SourceSafe [Advanced...]

Logon ID (SourceSafe):
 MYFAVID

Perform background status updates every 500 ms

Display output messages from plug-in

Get everything when opening a project

Check in everything when closing a project

Don't show Check Out dialog box when checking out items

Don't show Check In dialog box when checking in items

Keep items checked out when checking in or adding items

If dialogs were hidden using Don't show this again, click Reset to view them again. [Reset]

If a compatible plug-in cannot be found on your system, the following message is displayed:

"Registration of installed source control providers could not be found or is incomplete."

Some source control systems might not install the source control plug-in automatically, in which case you will need to install it separately. For further instructions, refer to the documentation of the respective source control system. A plug-in (provider) compatible with the Microsoft Source Code Control Plug-in API is expected to be registered under the following registry entry on your operating system:

HKEY_LOCAL_MACHINE\SOFTWARE\SourceCodeControlProvider\InstalledSCCProviders

Upon correct installation, the plug-in becomes available automatically in the list of plug-ins available to XMLSpy.

Accessing the source control commands

The commands related to source control are available in the **Project | Source Control** menu.

Resource / Speed issues

Very large source control databases might be introducing a speed/resource penalty when automatically performing background status updates.

You might be able to speed up your system by disabling (or increasing the interval of) the **Perform background status updates every ... seconds** option in the **Source Control** tab accessed through **Tools | Options**.

Note: The **64-bit** version of your Altova application automatically supports any of the supported 32-bit source control programs listed in this documentation. When using a 64-bit Altova application with a 32-bit source control program, the **Perform background status updates every ... seconds** option is automatically grayed-out and cannot be selected.

Differencing with Altova DiffDog

You can configure many source control systems (including Git and TortoiseSVN) so that they use Altova DiffDog as their differencing tool. For more information about DiffDog, see <https://www.altova.com/diffdog>. For DiffDog documentation, see <https://www.altova.com/documentation.html>.

22.1 Setting Up Source Control

The mechanism for setting up source control and placing files in a XMLSpy project under source control is as follows:

1. If this hasn't been done already, install the source control system (see [Supported Source Control Systems](#)⁷⁴⁵) and set up the source control database (repository) to which you wish to save your work.
2. Create a local workspace folder that will contain the working files that you wish to place under source control. The folder that contains all your workspace folders and files is called the local folder, and the path to the local folder is referred to as the local path. This local folder will be bound to a particular folder in the repository.
3. In your Altova application, create an application project folder to which you must add the files you wish to place under source control. This organization of files in an application project is abstract. The files in a project reference physical files saved locally, preferably in one folder (with sub-folders if required) for each project.
4. In the source control system's database (also referred to as source control or repository), a folder is created that is bound to the local folder. This folder (called the bound folder) will replicate the structure of the local folder so that all files to be placed under source control are correctly located hierarchically within the bound folder. The bound folder is usually created when you add a file or an application project to source control for the first time. See the section, [Application Project](#)⁷⁴⁸, for information about the repository's folder structure.
5. Project files are added to source control using the command **Project | Source Control | Add to Source Control**. When you add a project or a file in a project for the first time to source control, the correct bindings and folder structure will be created in the repository.
6. Source control actions, such as the checking in and out of files, and the removing of files from source control, can be carried out via commands in the **Project | Source Control** submenu. These commands are described in the [Project menu section](#)⁸²⁷ of the Menu Reference.

Note: If you wish to change the current source control provider, this can be done in one of two ways: (i) via the Source Control options ([Tools | Options | Source Control](#)¹⁰⁷⁴), or (ii) in the Change Source Control dialog (**Project | Source Control | Change Source Control**).

22.2 Supported Source Control Systems

The list below shows the Source Control Servers (SCSs) supported by XMLSpy, together with their respective Source Control Clients (SCCs). The list is organized alphabetically by SCS. Note the following:

- Altova has implemented the Microsoft Source Control Plug-in API (versions 1.1, 1.2, and 1.3) in XMLSpy, and has tested support for the listed drivers and revision control systems. It is expected that XMLSpy will continue to support these products if, and when, they are updated.
- Source Code Control clients not listed below, but which implement the Microsoft Source Control Plug-in API, should also work with XMLSpy.

| Source Control System | Source Code Control Clients |
|---|--|
| AccuRev 4.7.0 Windows | AccuBridge for Microsoft SCC 2008.2 |
| Bazaar 1.9 Windows | Aigenta Unified SCC 1.0.6 |
| Borland StarTeam 2008 | Borland StarTeam Cross-Platform Client 2008 R2 |
| Codice Software Plastic SCM Professional 2.7.127.10 (Server) | Codice Software Plastic SCM Professional 2.7.127.10 (SCC Plugin) |
| Collabnet Subversion 1.5.4 | <ul style="list-style-type: none"> • Aigenta Unified SCC 1.0.6 • PushOK SVN SCC 1.5.1.1 • PushOK SVN SCC x64 version 1.6.3.1 • TamTam SVN SCC 1.2.24 |
| ComponentSoftware CS-RCS (PRO) 5.1 | ComponentSoftware CS-RCS (PRO) 5.1 |
| Dynamsoft SourceAnywhere for VSS 5.3.2 Standard/Professional Server | Dynamsoft SourceAnywhere for VSS 5.3.2 Client |
| Dynamsoft SourceAnywhere Hosted | Dynamsoft SourceAnywhere Hosted Client (22252) |
| Dynamsoft SourceAnywhere Standalone 2.2 Server | Dynamsoft SourceAnywhere Standalone 2.2 Client |
| Git | PushOK GIT SCC plug-in (see Source Control with Git ⁷⁶²) |
| IBM Rational ClearCase 7.0.1 (LT) | IBM Rational ClearCase 7.0.1 (LT) |
| March-Hare CVSNT 2.5 (2.5.03.2382) | Aigenta Unified SCC 1.0.6 |
| March-Hare CVS Suite 2008 | <ul style="list-style-type: none"> • Jalindi Igloo 1.0.3 • March-Hare CVS Suite Client 2008 (3321) • PushOK CVS SCC NT 2.1.2.5 • PushOK CVS SCC x64 version 2.2.0.4 • TamTam CVS SCC 1.2.40 |
| Mercurial 1.0.2 for Windows | Sergey Antonov HgSCC 1.0.1 |
| Microsoft SourceSafe 2005 with CTP | Microsoft SourceSafe 2005 with CTP |

| Source Control System | Source Code Control Clients |
|--|--|
| Microsoft Visual Studio Team System 2008/2010 Team Foundation Server | Microsoft Team Foundation Server 2008/2010 MSSCCI Provider |
| Perforce 2008 P4S 2008.1 | Perforce P4V 2008.1 |
| PureCM Server 2008/3a | PureCM Client 2008/3a |
| QSC Team Coherence Server 7.2.1.35 | QSC Team Coherence Client 7.2.1.35 |
| Reliable Software Code Co-Op 5.1a | Reliable Software Code Co-Op 5.1a |
| Seapine Surround SCM Client/Server for Windows 2009.0.0 | Seapine Surround SCM Client 2009.0.0 |
| Serena Dimensions Express/CM 10.1.3 for Win32 Server | Serena Dimensions 10.1.3 for Win32 Client |
| Softimage Alienbrain Server 8.1.0.7300 | Softimage Alienbrain Essentials/Advanced Client 8.1.0.7300 |
| SourceGear Fortress 1.1.4 Server | SourceGear Fortress 1.1.4 Client |
| SourceGear SourceOffsite Server 4.2.0 | SourceGear SourceOffsite Client 4.2.0 (Windows) |
| SourceGear Vault 4.1.4 Server | SourceGear Vault 4.1.4 Client |
| VisualSVN Server 1.6 | <ul style="list-style-type: none"> • Aigenta Unified SCC 1.0.6 • PushOK SVN SCC 1.5.1.1 • PushOK SVN SCC x64 version 1.6.3.1 • TamTam SVN SCC 1.2.24 |

22.3 Local Workspace Folder

The files you will be working with should be saved in a hierarchy inside a local workspace folder (see *diagram below*).

Local Workspace Folder

```
|
|-- MyProject.spp
|-- QuickStart
|   |-- QuickStart.css
|   |-- QuickStart.xml
|   |-- QuickStart.xsd
|-- Grouping
|   |-- Persons
|       |-- Persons.xml
```

The application project file (`.spp` file) typically will be located directly inside the local workspace folder (see *diagram above*).

When one or more files in this (workspace) folder are placed under source control, the local workspace folder's structure is partly or wholly reproduced in the repository. For example, if the file `Persons.xml` from the local folder shown above is placed under source control, then the path to it in the repository will be:

```
[RepositoryFolder]/MyProject/Grouping/Persons/Persons.xml
```

The `MyProject` folder in the repository folder is bound to the local folder. Typically it would be the name of the project, but you could give it any name.

If the entire application project is placed under source control (by selecting the project name in the Projects window and placing it under source control), then the entire local folder structure is recreated in the repository.

Note: Files from outside the local workspace folder can be added to the application project. But whether you can place such a file under source control depends upon the source control system you are using. Some source control systems could have a problem placing a file from outside the local folder into the repository. We therefore recommend that all project files you wish to place under source control be located in the local workspace folder.

22.4 Application Project

Create or load the Altova application project you wish to place under source control. If you wish to place a single file under source control, this file must be included in a project—since source control can only be accessed via a project.

For example, consider a project in Altova's XMLSpy application. The project's properties are saved in a `.spp` file. In the application, the project is displayed in the application's Project window (see *screenshot below*). The project in the screenshot below is named `MyProject` and the project's properties are saved in the file `MyProject.spp`.

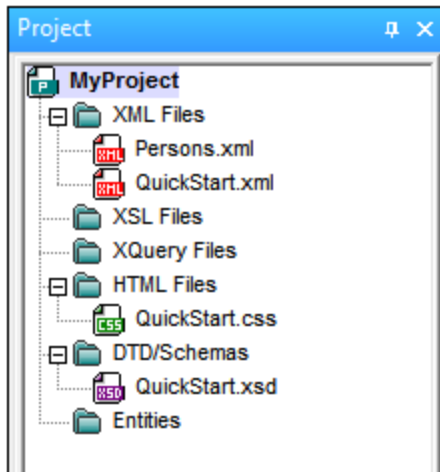

You can place the entire project (all files in the project) or only some project files under source control. **Only files that are in the project can be placed under source control.** So you will need to add files to the project before you can place them under source control. The project file (`.spp` file) will automatically be placed under source control as soon as a file from within the project is placed under source control.

The entire project, or one or more project files, is placed under source control via the command **Project | Source Control | Add to Source Control** (see *next section below*).

Note, however, that the folder structure of the repository corresponds not to the project's folder structure (*screenshot above*) but to the structure of the [local workspace folder](#)⁷⁴⁷ (see *folder diagram below*). In the diagram below, notice that the `MyProject` folder in the repository has a folder structure corresponding to that of the local workspace folder. Note that the bound folder occurs within the repository folder.

Local Workspace Folder

```
|
|-- MyProject.spp
|-- QuickStart
|   |-- QuickStart.css
|   |-- QuickStart.xml
|   |-- QuickStart.xsd
|-- Grouping
|   |-- Persons
```

Repository

```
|
|-- MyProject (bound to Local Workspace)
|   |-- MyProject.spp
|   |-- QuickStart
|       |-- QuickStart.css
|       |-- QuickStart.xml
|       |-- QuickStart.xsd
|   |-- Grouping
```



```
| | |-- Persons.xml          || |-- Persons
                             || | |-- Persons.xml
```

Note: An application project can contain project folders (green) and external folders (yellow). Only files in (green) project folders can be placed under source control. Files in (yellow) external folders cannot be placed under source control.

Note: Files from outside the local workspace folder can be added to the application project. But whether you can place such a file under source control depends upon the source control system you are using. Some source control systems could have a problem placing a file from outside the local folder into the repository. We therefore recommend that all project files you wish to place under source control be located in the local workspace folder.

22.5 Add to Source Control

Adding the project to source control will automatically create the correct bindings and repository structure before adding the project file (.spp file) or individual files to source control. Add the project to source control as follows.

Select the project in the Project window (MyProject in the screenshot below) so that it is highlighted (as in the screenshot below). Alternatively select a single file, or select multiple files by clicking them with the **Ctrl** key pressed. Adding a single file to source control will automatically add the project file (.spp file) to source control as well.

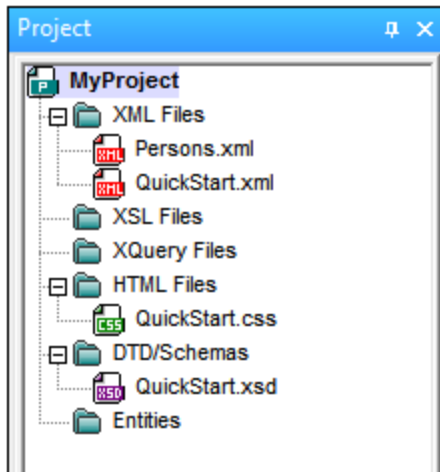

Next, select the menu command **Project | Source Control | Add to Source Control**. This pops up the connection and configuration dialogs of the currently selected source control system. (You can change the source control system via the Change Source Control dialog (**Project | Source Control | Change Source Control**)).

Follow the source control system's instructions to make the connection and configuration. After this has been completed, all the files selected for addition plus the project file (.spp file) are displayed in an Add to Source Control dialog (screenshot below). Select the files you wish to add and click **OK**.

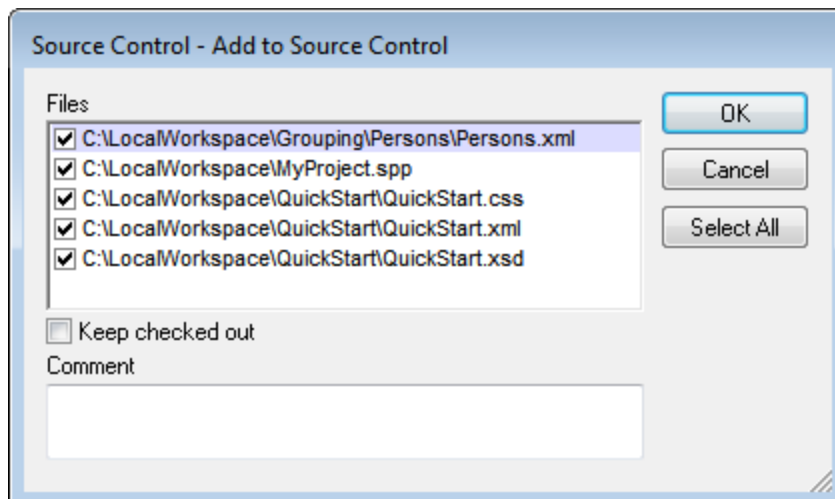

The files will be added to the repository and be either [checked in or checked out](#)⁷⁵³ depending on whether the *Keep Checked Out* check box has been checked or not.

Configuration notes

You might be prompted to create a folder in the repository for the project if it has not already been created. If you are, go ahead and create it. The [local workspace folder](#)⁷⁴⁷ will be bound to this folder created in the repository (see *diagrams below*).

| <u>Local Workspace Folder</u> | <u>Repository</u> |
|-------------------------------|--|
| | |
| -- MyProject.spp | -- <u>MyProject (bound to Local Workspace)</u> |
| -- QuickStart | -- MyProject.spp |
| -- QuickStart.css | -- QuickStart |
| -- QuickStart.xml | -- QuickStart.css |
| -- QuickStart.xsd | -- QuickStart.xml |
| -- Grouping | -- QuickStart.xsd |
| -- Persons | -- Grouping |
| -- Persons.xml | -- Persons |
| | -- Persons.xml |

The configuration dialog of Jalindi Igloo is show below. The CVSROOT field is the path to the repository folder.

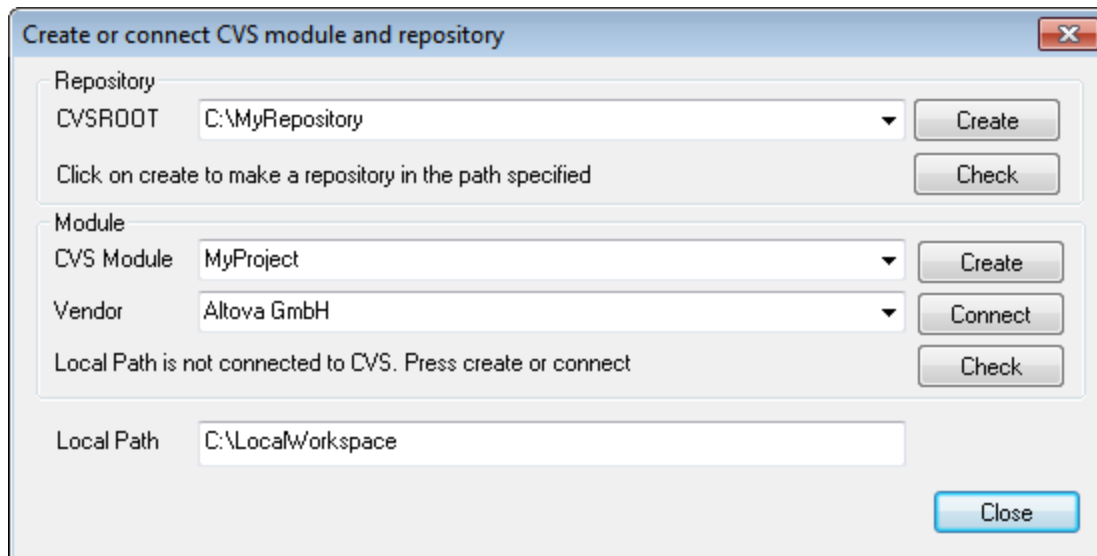

In the screenshot above, the local path locates the local workspace folder, which corresponds to the CVS module, `MyProject`, and is bound to it.

22.6 Working with Source Control

To work with source control, select the project, a project folder, or a project file in the Project window (*screenshot below*) and then select the command you want in the **Project | Source Control** menu. The **Check In** and **Check Out** commands are available as context menu commands of Project window items.

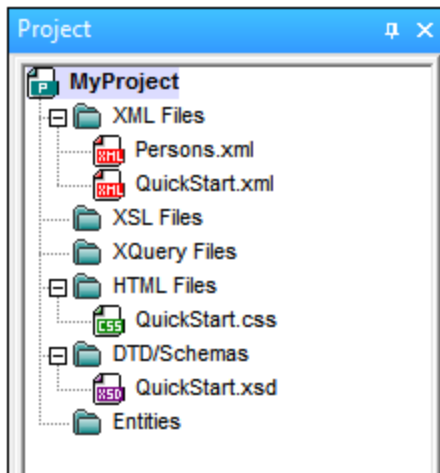

In this section, we describe the main source control features in detail:

- [Add to, Remove from Source Control](#) ⁷⁵²
- [Check Out, Check In](#) ⁷⁵³
- [Getting Files as Read-Only](#) ⁷⁵⁵
- [Copying and Sharing from Source Control](#) ⁷⁵⁷
- [Changing Source Control](#) ⁷⁶⁰

Additional commands in the **Project | Source Control** menu are described in the [Menu Reference section](#) ⁸²⁷ of the manual. For information specific to a particular source control system, please see the user documentation of that system.

22.6.1 Add to, Remove from Source Control

Adding

After a project has been added to source control, you can place files either singly or in groups under source control. This is also known as adding the files to source control. Select the file in the Project window and then click the command **Project | Source Control | Add to Source Control**. To select multiple files, keep the **Ctrl** key pressed while clicking on the files you wish to add. Running the command on a (green) project folder (*see screenshot below*) adds all files in the folder and its sub-folders to source control.

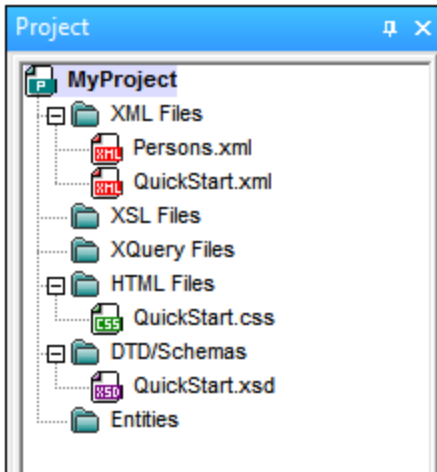



When files are added to source control, the [local folder hierarchy is replicated in the repository](#)⁷⁴⁸ (it is not the project folder hierarchy that is replicated). So, if a file is in a sub-folder X levels deep in the local folder, then the file's parent folder and all other ancestor folders are automatically created in the repository.

When the first file from a project is added to source control, the correct bindings are created in the repository and the project file (.spp file) is added automatically. For more details, see the section [Add to Source Control](#)⁷⁵⁰.

Source control symbols

Files and the project folder display certain symbols, the meanings of which are given below.

| | |
|---|---|
|  | Checked in. Available for check-out. |
|  | Checked out by another user. Not available for check-out. |
|  | Checked out locally. Can be edited and checked-in. |

Removing

To remove a file from source control, select the file and click the command **Project | Source Control | Remove from Source Control**. You can also remove: (i) files in a project folder by executing the command on the folder, and (ii) the entire project by executing the command on the project.



22.6.2 Check Out, Check In

After a project file has been placed under source control, it can be checked out or checked in by selecting the file (in the Project window) and clicking the respective command in the **Project | Source Control** menu: **Check Out** and **Check In**.

When a file is checked out, a copy from the repository is placed in the local folder. A file that is checked out can be edited. If a file that is under source control is not checked out, it cannot be edited. After a file has been edited, the changes can be saved to the repository by checking in the file. Even if the file is not saved in the

application, checking it in will save the changes to the repository. Whether a file is checked out or not is indicated with a tick or lock symbol in its Project window icon.

Files and the project folder display certain symbols, the meanings of which are given below.

| | |
|---|---|
|  | Checked in. Available for check-out. |
|  | Checked out by another user. Not available for check-out. |
|  | Checked out locally. Can be edited and checked-in. |

Selecting the project or a folder within the project selects all files in the selected object. To select multiple objects (files and folders), press the **Ctrl** key while clicking the objects. The screenshot below shows a project that has been checked out. The file `QuickStart.css` has subsequently been checked in.

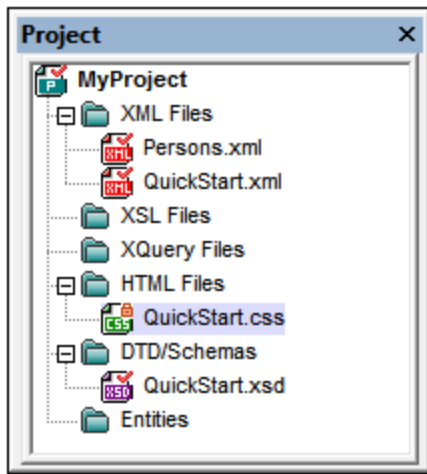

[Getting Files as Read-Only](#) ⁷⁵⁵

Saving and rejecting editing changes

Note that, when checking in a file, you can choose to leave the file checked out. What this does is save editing changes to the repository while continuing to keep the file checked out, which is useful if you wish to periodically save editing changes to the repository and then continue editing.

If you have checked out a file and made editing changes, and then wish to reject these changes, you can revert to the document version saved in the repository by selecting the command **Project | Source Control | Undo Check Out**.

Checking out

The Check Out dialog (*screenshot below*) allows you: (i) to select the files to check out, and (ii) to select whether the repository version or the local version should be checked out.

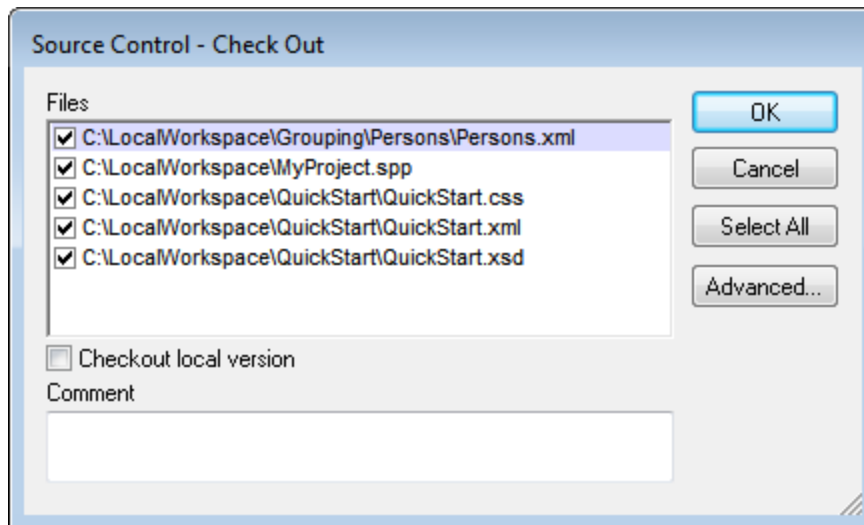

Checking in

The Check In dialog (*screenshot below*) allows you: (i) to select the files to check in, and (ii) if you wish, to keep the file checked out.

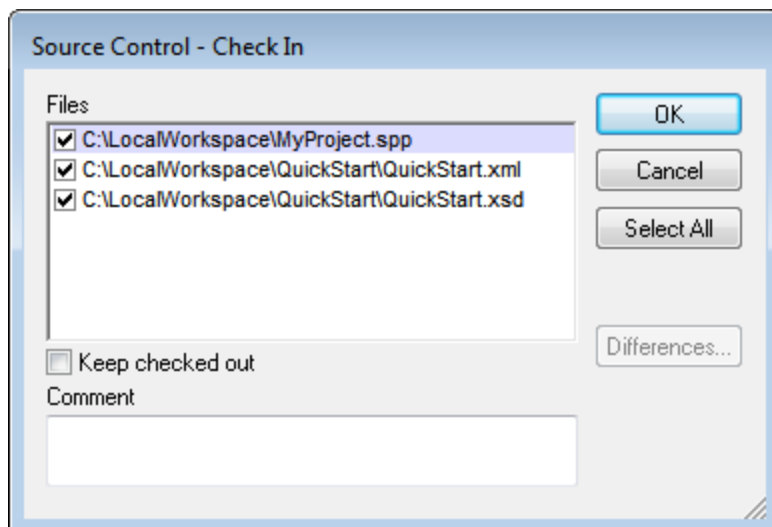

Note: In both dialogs (Check Out and Check In), multiple files appear if the selected object (project or project folder/s) contain multiple files.

22.6.3 Getting Files as Read-Only

The **Get** command (in the **Project | Source Control** menu) retrieves files from the repository as read-only files. (To be able to edit a file, you must [check it out](#)⁷⁵³.) The Get dialog lists the files in the object (project or folder) on which the **Get** command was executed (*see screenshot below*). You can select the files to retrieve by checking them in the Get dialog list.

Note: The **Get Folders** command allows you to select individual sub-folders in the repository if this is allowed by your source control system, .

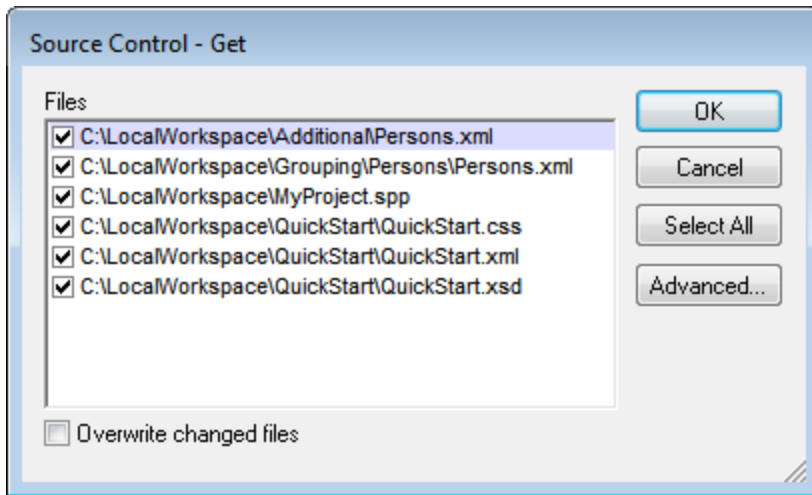

You can choose to overwrite changed checked-out files by checking this option at the bottom of the Get dialog. On clicking **OK**, the files will be overwritten. If any of the overwritten files is currently open, a dialog pops up (*screenshot below*) asking whether you wish to reload the file/s (**Reload** button), close the file/s (**Close**), or retain the current view of the file (**Cancel**).

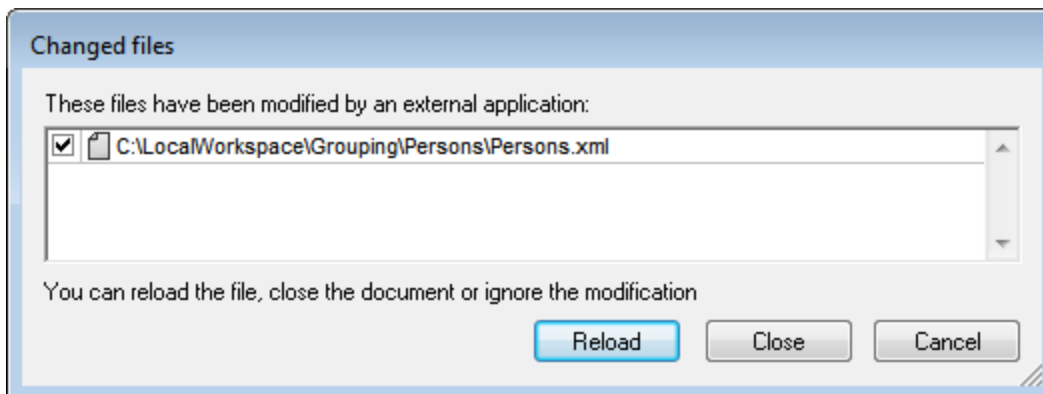

Advanced Get Options

The Advanced Get Options dialog (*screenshot below*) is accessed via the **Advanced** button in the Get dialog (see first screenshot in this section).

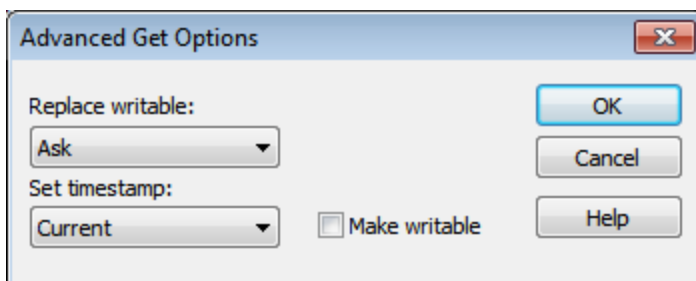

Here you can set options for (i) replacing writable files that are checked out, (ii) the timestamp, and (iii) whether the read-only property of the retrieved file should be changed so that it will be writable.

Get latest version

The **Get Latest Version** command (in the **Project | Source Control** menu) retrieves and places the latest source control version of the selected file(s) in the working directory. The files are retrieved as read-only and are not checked out. This command works like the **Get** command (see *above*), but does not display the Get dialog.

If the selected files are currently checked out, then the action taken will depend on how your source control system handles such a situation. Typically, the source control system will ask whether you wish to replace, merge with, or leave the checked-out file as it is.

Note: This command is recursive when performed on a folder, that is, it affects all files below the current one in the folder hierarchy.

22.6.4 Copying and Sharing from Source Control

The **Open from Source Control** command creates a new application project from a project under source control.

Create the new project as follows:

1. Depending on the source control system used, it might be necessary, before you create a new project from source control, to make sure that no file from the source-controlled project is checked out.
2. No project need be open in the application, but can be.
3. Select the command **Project | Source Control | Open from Source Control**.
4. The source control system that is currently set will pop up its verification and connection dialogs. Make the connection to the [bound folder in the repository](#)⁷⁴⁸ that you want to copy.
5. In the dialog that pops up (*screenshot below*), browse for the local folder to which the contents of the bound folder in the repository (that you have just connected to) must be copied. In the screenshot below the bound folder is called `MyProject` and is represented by the \$ sign; the local folder is `C:\M20130326`.

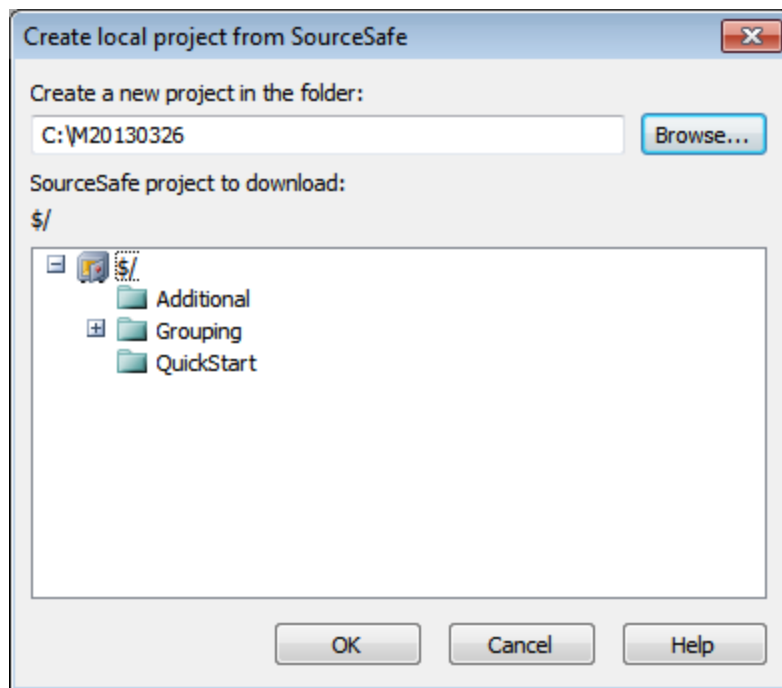

6. Click **OK**. The contents of the bound folder (`MyProject`) will be copied to the local folder `C:\M20130326.`, and a dialog pops up asking you to select the project file (`.spp` file) that is to be created as the new project.
7. Select the `.spp` file that will have been copied to the local folder. In our example, this will be `MyProject.spp` located in the `C:\M20130326` folder. A new project named `MyProject` will be created in the application and will be displayed in the Project window. The project's files will be in the folder `C:\M20130326.`

Sharing from source control

The **Share from Source Control** command is supported when the source control system being used supports shares. You can share a file, so that it is available at multiple local locations. A change made to one of these local files will be reflected in all the other "shared" versions.

In the application's Project window first select the project (*highlighted in the screenshot below*). Then click the **Share from Source Control**.

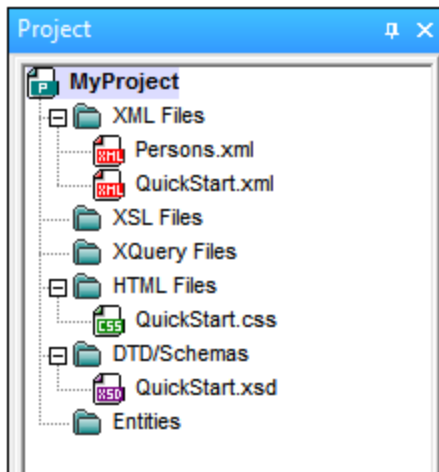

The Share To [Folder] dialog (*screenshot below*) pops up.

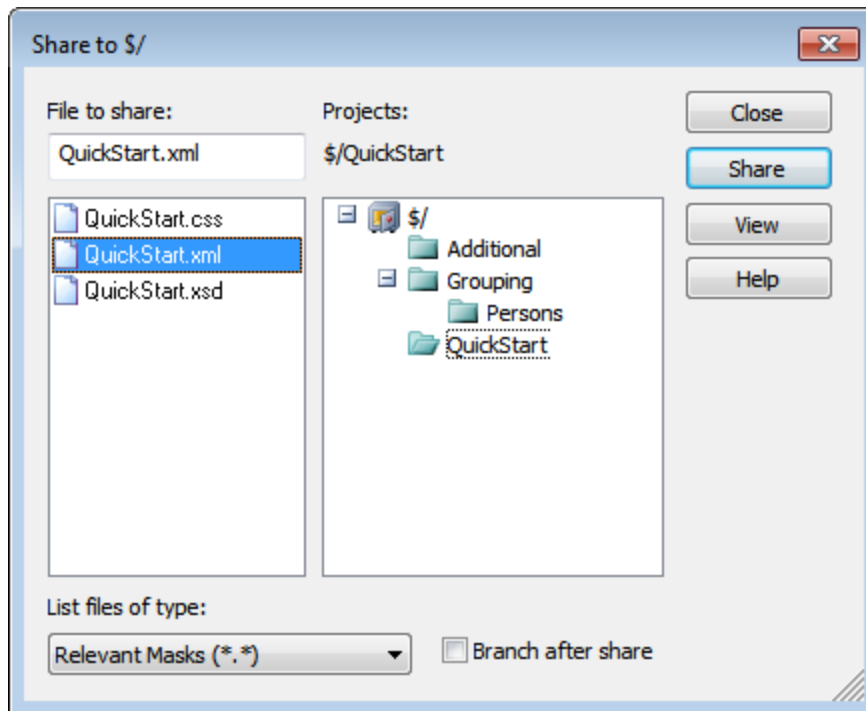

To select the files to share, first choose, in the project tree in the right-hand pane of the dialog (*see screenshot above*), the folder in which the files are. The files in the chosen folder are displayed in the left-hand pane. Select the file you wish to share (multiple files by pressing the **Ctrl** key and clicking the files you want to share). The selected file/s will be displayed in the *Files to Share* text box (*at top left*). The files disappear from the left hand pane. Click **Share** and then **Close** to copy the selected file/s to the local share folder. When you click **Close**, the files to share will be copied to the selected local location.

The share folder is noted in the name of the Share to [Folder] dialog. In the screenshot above it is the local folder (since the $\$$ sign is the folder in the repository to which the local folder is bound). You can see and set the share folder in the Change Source Control dialog (*screenshot below*, **Change Source Control**) by changing the local path and server binding.

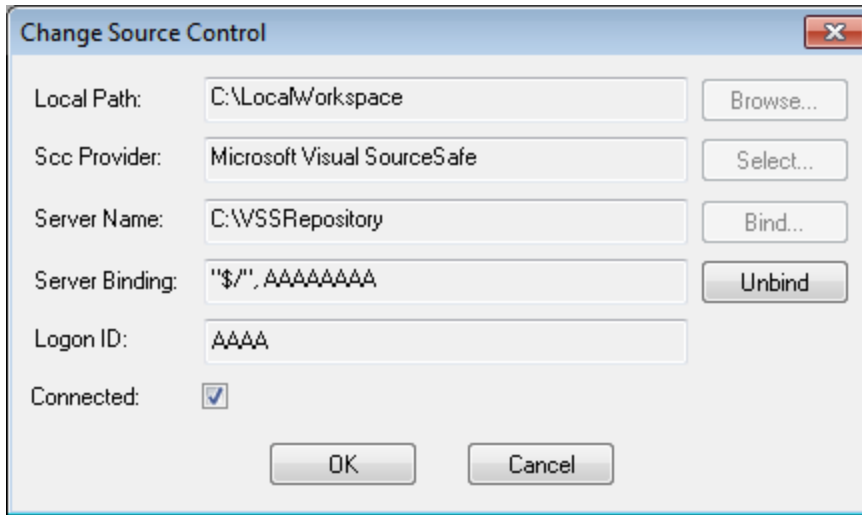

For more details about sharing using your source control system, see the source control system's user documentation.

22.6.5 Changing Source Control

Source control settings can be changed via two commands in the **Project | Source Control** menu:

- **Source Control Manager**, which opens the source control system application and allows you to set up databases and configure bindings.
- **Change Source Control**, which pops up the Change Source Control dialog, in which you can change the source control system being used by the Altova application and the current binding. This dialog is described below.

The current binding is what the active application project will use to connect to the source control database. The current binding is correct when the application project file (.spp file) is in the local folder and the bound folder in the repository is where this project's files are stored. Typically the bound folder and its sub-structure will correspond with the local workspace folder and its sub-structure.

In the Change Source Control dialog (*screenshot below*), you can change the source control system (SCC *Provider*), the local folder (*Local Path*), and the repository binding (*Server Name* and *Server Binding*).

Only after undoing the current binding can the settings be changed. Undo the current binding with the **Unbind** button. All the settings are now editable.

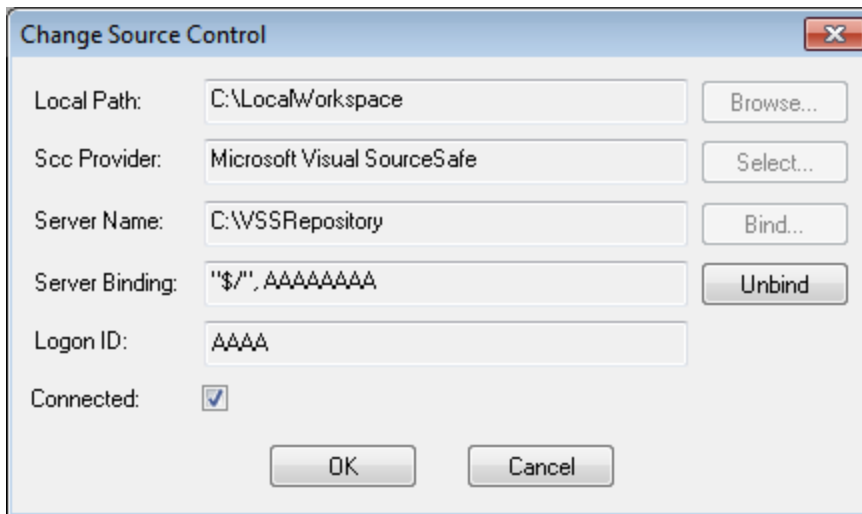

Change source control settings as follows:

1. Use the **Browse** button to browse for the local folder and the **Select** button to select from among the installed source control systems.
2. After doing this you can bind the local folder to a repository database. Click the **Bind** button to do this. This pops up the connection dialog of your source control system.
3. If you have entered a *Logon ID*, this will be passed to the source control system; otherwise you might have to enter your logon details in the connection dialog.
4. Select the database in the repository that you wish to bind to this local folder. This setting might be spread over more than one dialog.
5. After the setting has been created, click **OK** in the Change Source Control dialog.

22.7 Source Control with Git

Support for Git as a source control system in XMLSpy is available through a third-party plug-in called **GIT SCC plug-in** (<http://www.pushok.com/software/git.html>).

At the time when this documentation is written, the **GIT SCC plug-in** is available for experimental use. Registration with the plug-in publisher is required in order to use the plug-in.

The GIT SCC plug-in enables you to work with a Git repository using the commands available in the **Project | Source Control** menu of XMLSpy. Note that the commands in the **Project | Source Control** menu of XMLSpy are provided by the Microsoft Source Control Plug-in API (MSSCCI API), which uses a design philosophy different from Git. As a result, the plug-in essentially mediates between "Visual Source Safe"-like functionality and Git functionality. On one hand, this means that a command such as **Get latest version** may not be applicable with Git. On the other hand, there are new Git-specific actions, which are available in the "Source Control Manager" dialog box provided by the plug-in (under the **Project | Source Control | Source Control Manager** menu of XMLSpy).

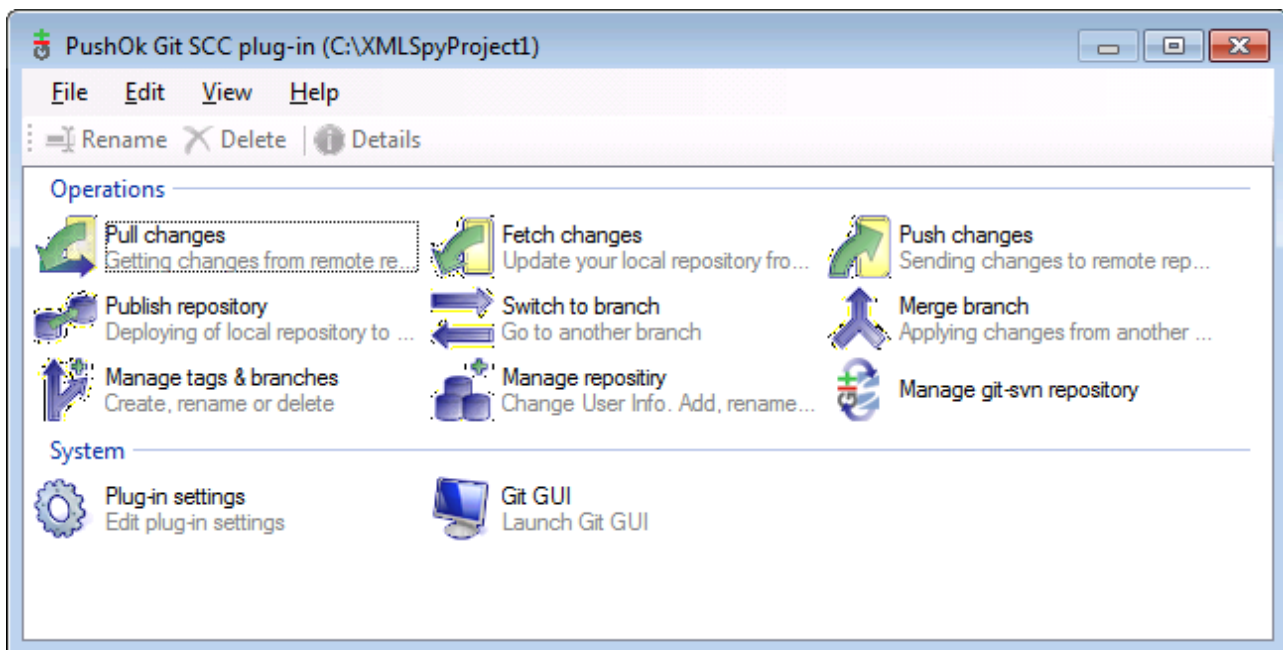

The Source Control Manager dialog box

Other commands that you will likely need to use frequently are available directly under the **Project | Source Control** menu.

The following sections describe the initial configuration of the plug-in, as well as the basic workflow:

- [Enabling Git Source Control with GIT SCC Plug-in](#) ⁷⁶³
- [Adding a Project to Git Source Control](#) ⁷⁶³
- [Cloning a Project from Git Source Control](#) ⁷⁶⁵

22.7.1 Enabling Git Source Control with GIT SCC Plug-in

To enable Git source control with XMLSpy, the third-party **PushOK GIT SCC plug-in** must be installed, registered, and selected as source control provider, as follows:

1. Download the plug-in installation file from the publisher's website (<http://www.pushok.com>), run it, and follow the installation steps.
2. On the **Project** menu of XMLSpy, click **Change Source Control**, and make sure **PushOk GITSCC** is selected as source control provider. If you do not see **Push Ok GITSCC** in the list of providers, it is likely that the installation of the plug-in was not successful. In this case, check the publisher's documentation for a solution.

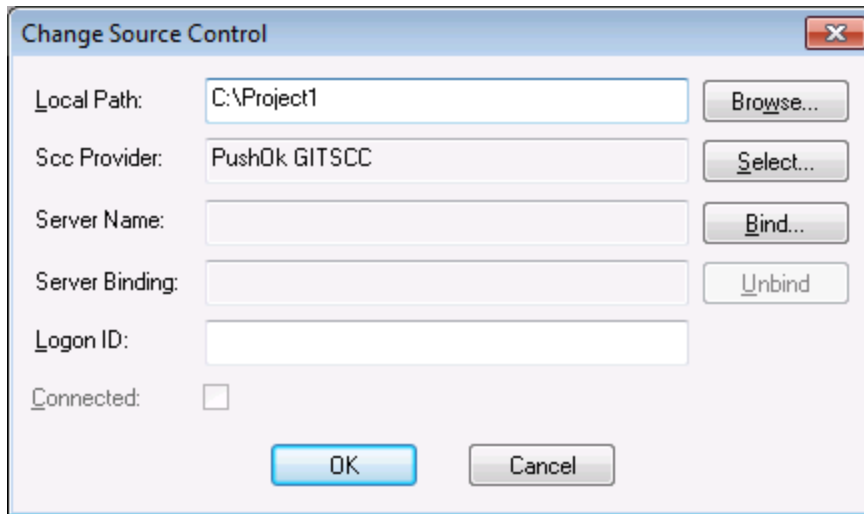

3. When a dialog box prompts you to register the plug-in, click **Registration** and follow the wizard steps to complete the registration process.

22.7.2 Adding a Project to Git Source Control

You can save XMLSpy projects as Git repositories. The structure of files or folders that you add to the project would then correspond to the structure of the Git repository.

To add a project to Git source control:

1. Make sure that **PushOK GIT SCC Plug-in** is set as source control provider (see [Enabling Git Source Control with GIT SCC Plug-in](#)⁷⁶³).
2. Create a new project using the menu command **Project | Create Project**.
3. Save the project to a local folder, for example `C:\MyRepo\Project.spp`
4. On the **Project** menu, under **Source Control**, click **Add to Source Control**.

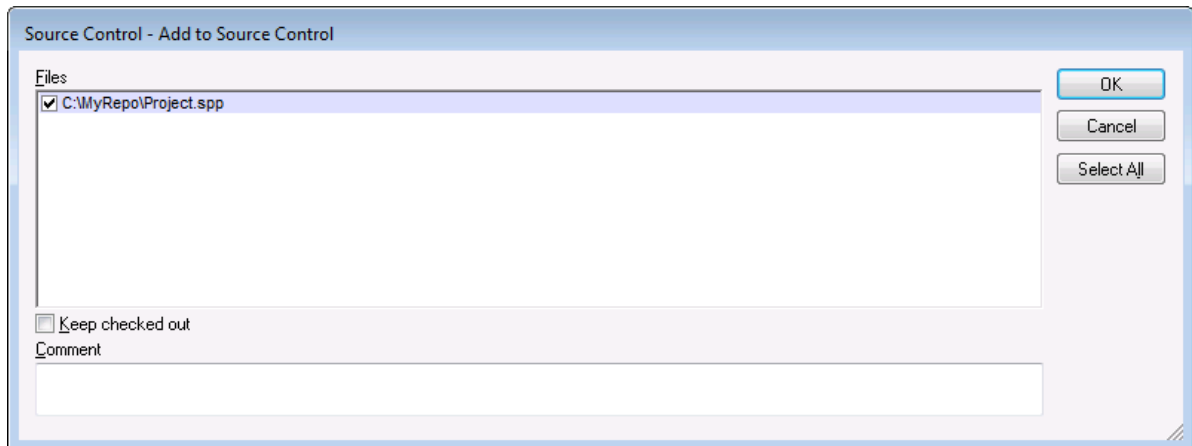

5. Click **OK**.

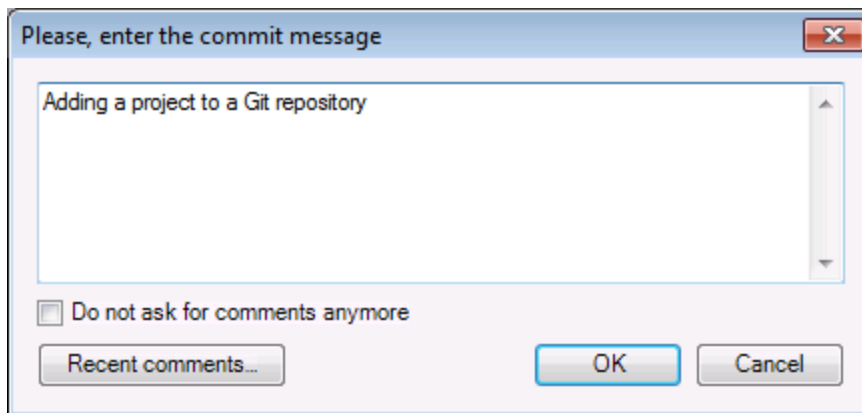

6. Enter the text of your commit message, and click **OK**.

You can now start adding files and folders to your project. Note that all project files and folders must be under the root folder of the project. For example, if the project was created in the `C:\MyRepo` folder, then only files under `C:\MyRepo` should be added to the project. Otherwise, if you attempt to add to your project files that are outside the project root folder, a warning message is displayed:

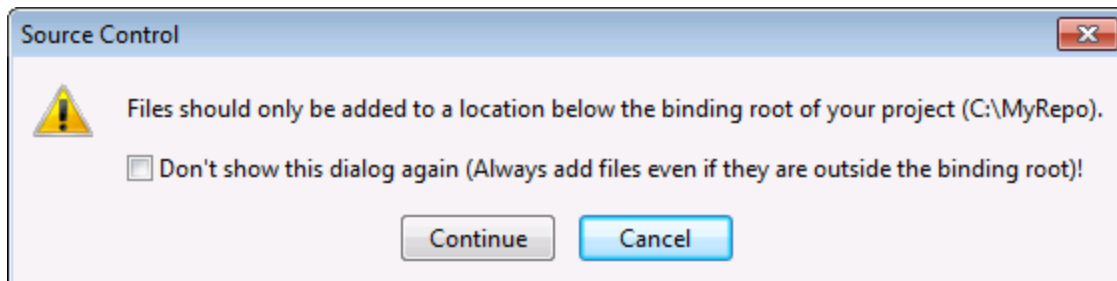

22.7.3 Cloning a Project from Git Source Control

Projects that have been previously added to Git source control (see [Adding a Project to Git Source Control](#)⁷⁶³) can be opened from the Git repository as follows:

1. Make sure that **PushOK GIT SCC Plug-in** is set as source control provider (see [Enabling Git Source Control with GIT SCC Plug-in](#)⁷⁶³).
2. On the **Project** menu, click **Source Control | Open from Source Control**.
3. Enter the path or the URL of the source repository. Click **Check** to verify the validity of the path or URL.

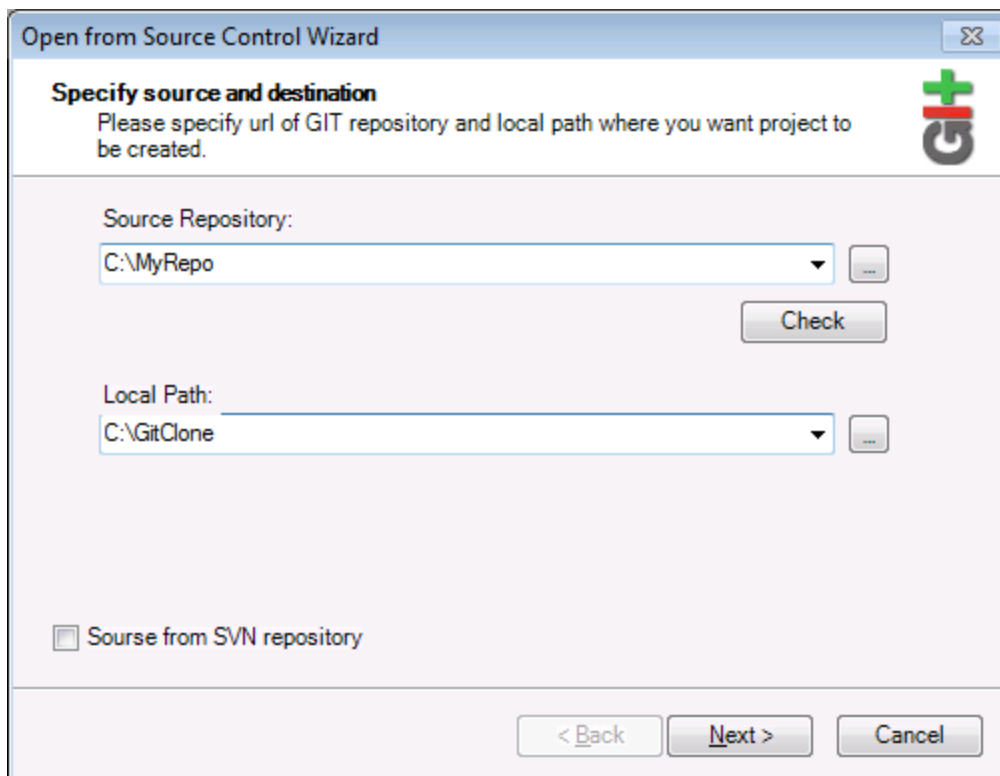

4. Under **Local Path**, enter the path to local folder where you want the project to be created, and click **Next**. If the local folder exists (even if it is empty), the following dialog box opens:

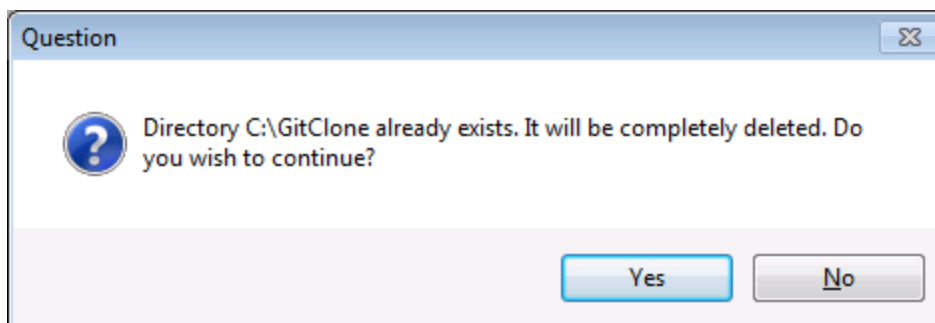

5. Click **Yes** to confirm, and then click **Next**.

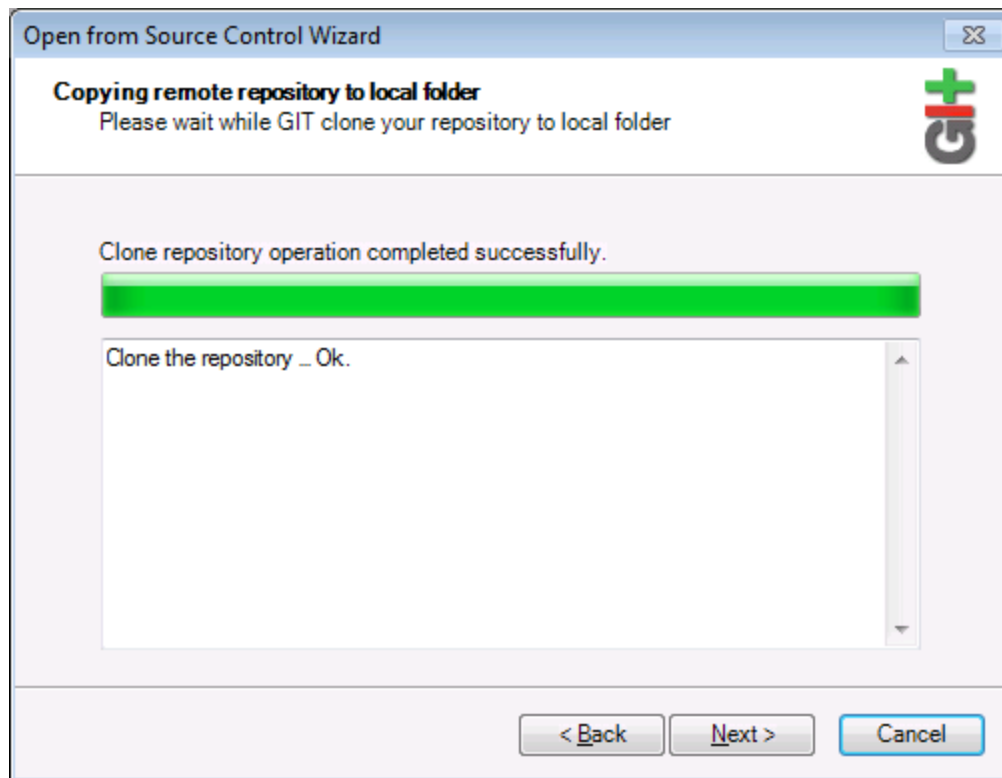

6. Follow the remaining wizard steps, as required by your specific case.
7. When the wizard completes, a Browse dialog box appears, asking you to open the XMLSpy Project (*.spp) file. Select the project file to load the project contents into XMLSpy.

23 XMLSpy in Visual Studio

XMLSpy can be integrated into the Microsoft Visual Studio IDE versions 2012/2013/2015/2017/2019/2022. This unifies the best of both worlds, integrating advanced XML editing capabilities with the advanced development environment of Visual Studio.

In this section, we describe:

- The [broad installation process](#)⁷⁶⁸ and the integration of the XMLSpy plugin in Visual Studio.
- [Differences](#)⁷⁶⁹ between the Visual Studio version and the standalone version.
- [XMLSpy's Debuggers](#)⁷⁷¹ in Visual Studio.

23.1 Installing the XMLSpy Plugin

To install the XMLSpy Plug-in for Visual Studio, take the steps below:

1. Install Microsoft Visual Studio 2012/2013/2015/2017/2019/2022. Note that from Visual Studio 2022 onwards, Visual Studio is being made available only as a 64-bit application.
2. Install XMLSpy (Enterprise or Professional Edition). If you have installed Visual Studio 2022+, then you must install the 64-bit version of XMLSpy.
3. Download and run the XMLSpy integration package for Microsoft Visual Studio. This package is available on the XMLSpy (Enterprise and Professional Editions) download page at www.altova.com.

Once the integration package has been installed, you will be able to use XMLSpy in the Visual Studio environment.

Important

You must use the integration package corresponding to your XMLSpy version (current version is 2024). The integration package is not edition-specific and can therefore be used for both Enterprise and Professional editions.

23.2 Differences with XMLSpy Standalone

This section lists the ways in which the Visual Studio versions differ from the standalone versions of XMLSpy. The listing starts with features that are unsupported in the Visual Studio version, and continues with a listing of other ways in which the Visual Studio version differs from the standalone version.

- [Unsupported features in Visual Studio](#) ⁷⁶⁹
- [Additional XMLSpy menus in Visual Studio](#) ⁷⁶⁹
- [Entry helpers in Visual Studio](#) ⁷⁶⁹
- [Same functionality, different command](#) ⁷⁶⁹
- [XMLSpy commands as Visual Studio commands](#) ⁷⁷⁰

Unsupported features in Visual Studio

The following XMLSpy features are not available in Visual Studio:

- The Scripting environment (**Tools | XMLSpy Options | Scripting**) is currently not supported. Toolbar icons that were created to execute scripts will therefore not be displayed.
- The text state icons of [Authentic View](#) ⁴⁴⁴ are not supported.
- Separate browser window (an option in the **Tools | Options | View** section) is not supported. This means the the Text View and Browser View are always in the same window.
- All Source Control functionality.
- All comparison functionality (available in the **Tools** menu of the standalone version).

Additional XMLSpy menus in Visual Studio

The following commands are specific to XMLSpy in Visual Studio:

- **View | XMLSpy Tool Windows**
- **View | XMLSpy View**
- **XMLSpy** (includes Global Resources menu items, and the possibility to switch XMLSpy themes)
- **Tools | XMLSPY Options**

Note: In Visual Studio 2019 and later, XMLSpy functionality can be accessed in the **Extensions** menu of Visual Studio. In earlier versions of Visual Studio, XMLSpy features are available in top-level menus of Visual Studio.

Entry helpers (Tool windows in Visual Studio)

The entry helpers of XMLSpy are available as Tool windows in Visual Studio. The following points about them should be noted. (For a description of entry helpers and the XMLSpy GUI, see the section, [GUI and Environment](#) ¹⁰⁷.)

- You can drag entry helper windows to any position in the development environment.
- Right-clicking an entry helper tab allows you to further customize your interface. Entry helper configuration options are: dockable, hide, floating, and auto-hide.

Same functionality, different command

Some functionality of XMLSpy is available in Visual Studio under differently named commands. These are:

| XMLSpy | Visual Studio | Functionality |
|-----------------------------|--------------------------------|---------------------|
| File Open Switch to URL | File Open Website | Opens file from URL |
| Switch to URL Save | File Save XMLSpy File to URL | Saves file to URL |

XMLSpy commands as Visual Studio commands

Some XMLSpy commands are present as Visual Studio commands in the Visual Studio GUI. These are:

- **Undo, Redo:** These Visual Studio commands affect all actions in the Visual Studio development environment.
- **Projects:** XMLSpy projects are handled as Visual Studio projects.
- **Customize Toolbars, Customize Commands:** The Toolbars and Commands tabs (*screenshot below*) in the Customize dialog (**Tools | Customize**) contain both Visual Studio commands as well as XMLSpy commands.

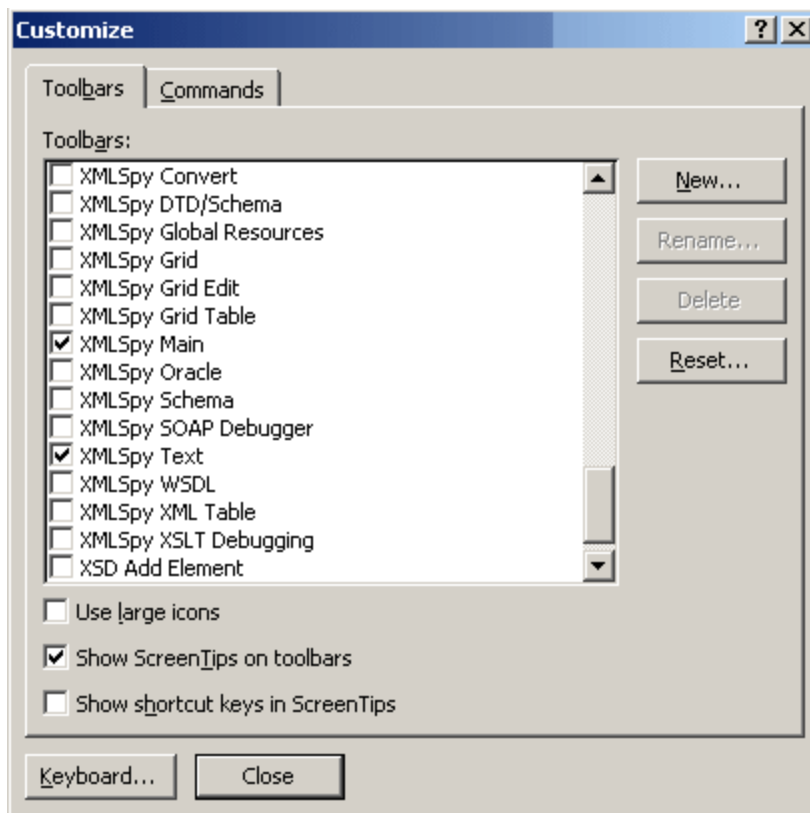

- **Views:** In the **View** menu, the two commands, **XMLSpy Tool Windows** and **XMLSpy View**, contain options to toggle on entry helper windows and other sidebars, switch between the editing views, and toggle certain editing guides on and off.
- **XMLSpy Help:** This XMLSpy menu appears as a submenu in Visual Studio's **Help** menu.

23.3 XMLSpy's Debuggers in Visual Studio

XMLSpy contains an XSLT/XQuery Debugger (*Enterprise and Professional editions*) and a SOAP Debugger (*Enterprise edition*). A debugger process involves the display of more than one file (for example, XML, XSLT, and XSLT output files), all of which are displayed in Visual Studio as a single tabbed group. To make the debugging easier to follow, you can create one or more additional tab groups in Visual Studio. Do this as follows:

1. Click the tab you wish to separate from the single tabbed group, then drag and drop it somewhere in the currently active tab. This opens a pop-up menu which allows you to define the type of tab you want to create.

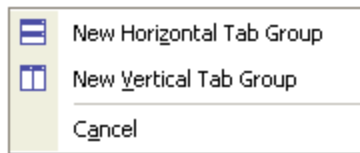

2. Select **New Vertical Tab Group**. This creates a new tab containing just the selected tab (*screenshot below*).

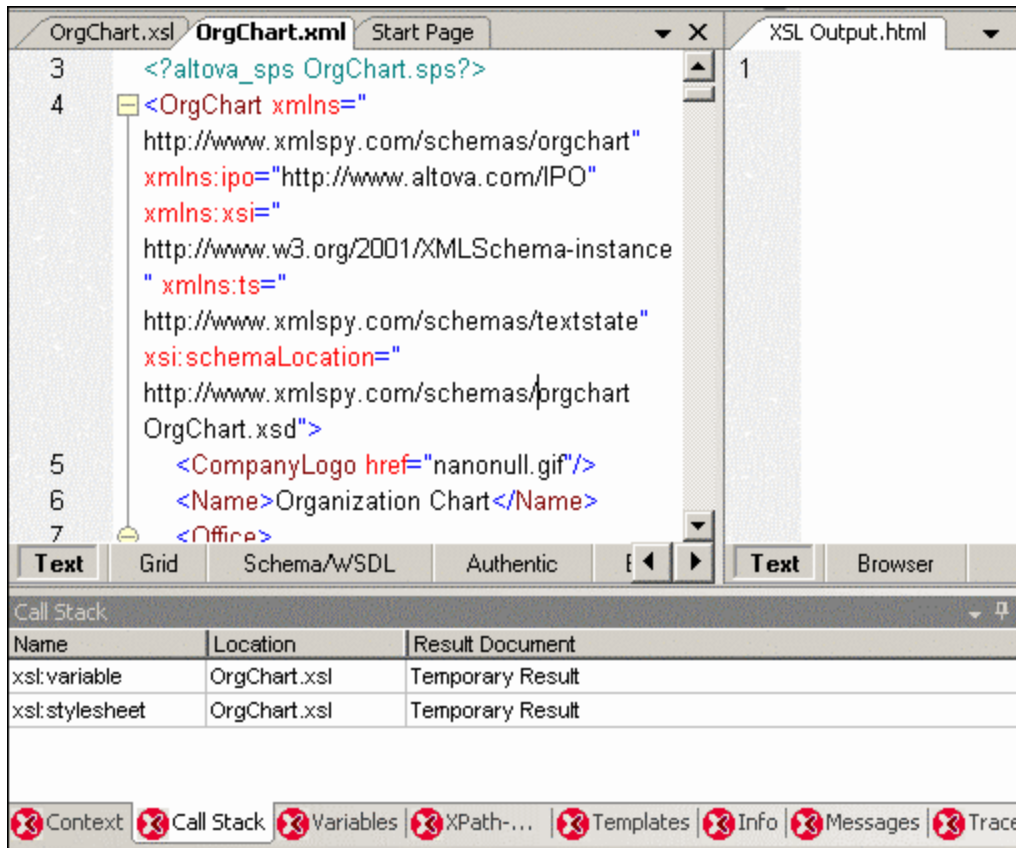

24 XMLSpy in Eclipse

Eclipse is an open source framework that integrates different types of applications delivered in the form of plugins. The XMLSpy Integration Package for Eclipse enables you to integrate and access the functionality of XMLSpy in the Eclipse Platform for Windows. Supported Eclipse versions are: 2024-03 (4.31), 2023-12 (4.30), 2023-09 (4.29), 2023-06 (4.28).

In this section, we describe the following:

- [How to install the XMLSpy Integration Package for Eclipse and integrate XMLSpy in Eclipse](#) ⁷⁷³
- [The XMLSpy Perspective in Eclipse](#) ⁷⁷⁵
- [Other XMLSpy Entry Points in Eclipse](#) ⁷⁷⁸
- [XMLSpy Debugger perspectives](#) ⁷⁸⁰

Note: Source Control functionality, which is available in the standalone version of XMLSpy, is not supported in the Eclipse version.

24.1 Install the Integration Package for Eclipse

Prerequisites

- Eclipse 2024-03 (4.31), 2023-12 (4.30), 2023-09 (4.29), 2023-06 (4.28) (<http://www.eclipse.org>), 64-bit.
- A Java Runtime Environment (JRE) or Java Development Kit (JDK) for the 64-bit platform.
- XMLSpy Enterprise or Professional Edition 64-bit.

Note: All the prerequisites listed above must have the 64-bit platform. Integration with older Eclipse 32-bit platforms is no longer supported, although it may still work.

After the prerequisites listed above are in place, you can install the XMLSpy Integration Package (64-bit) to integrate XMLSpy in Eclipse. The integration can be carried out either during the installation of the Integration Package or manually from Eclipse after the Integration Package has been installed. The XMLSpy Integration Package is available for download at <https://www.altova.com/components/download>.

Note: Eclipse must be closed while you install or uninstall the XMLSpy Integration Package.

Integrate XMLSpy during installation of the Integration Package

You can integrate XMLSpy in Eclipse during the installation of the XMLSpy Integration Package. Do this as follows:

1. Run the XMLSpy Integration Package to start the installation wizard.
2. Go through the initial steps of the installation with the wizard.
3. In the Integration step, select *Let this wizard integrate Altova XMLSpy plug-in into Eclipse*, and browse for the directory where the Eclipse executable (`eclipse.exe`) is located.
4. Click **Next** and complete the installation.

The XMLSpy perspective and menus will be available in Eclipse the next time you start it.

Integrate XMLSpy in Eclipse manually

After you have installed the XMLSpy Integration Package, you can manually integrate XMLSpy in Eclipse as follows:

1. In Eclipse, select the menu command **Help | Install New Software**.
2. In the Install dialog box, click **Add**.

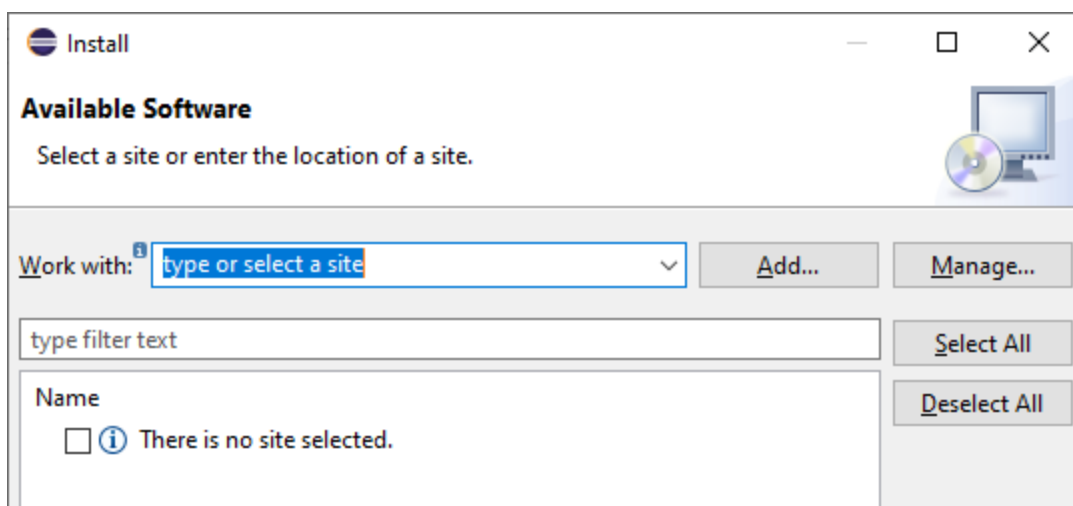

3. In the Add Repository dialog box, click **Local**. Browse for the folder `C:\Program Files\Altova\XMLSpy\2024\ eclipse\UpdateSite`, and select it. Provide a name for the site (such as "Altova").

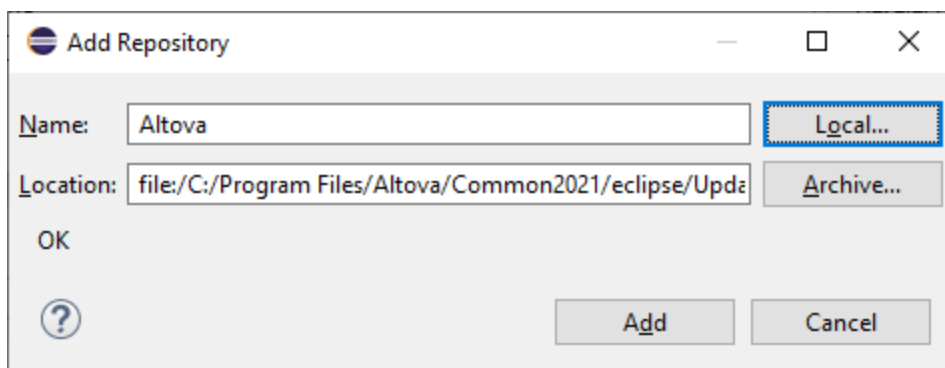

4. Repeat the steps 2-3 above, this time selecting the folder `C:\Program Files\Altova\XMLSpy\2024\ eclipse\UpdateSite` and providing a name such as "Altova XMLSpy".
5. On the Install dialog box, select *Only Local Sites*. Next, select the "Altova category" folder and click **Next**.
6. Review the items to be installed and click **Next** to proceed.
7. To accept the license agreement, select the respective check box.
8. Click **Finish** to complete the installation.

Note: If there are problems with the plug-in (missing icons, for example), start Eclipse from the command line with the `-clean` flag.

24.2 XMLSpy Perspective in Eclipse

In Eclipse, a perspective is a GUI view that is configured with the functionality of a specific application. After XMLSpy has been integrated in Eclipse, a new perspective, named XMLSpy, becomes available in Eclipse. This perspective is a GUI that resembles the XMLSpy GUI and includes a number of its components.

When a file having a filetype associated with XMLSpy is opened (.xml, for example), this file can be edited in the XMLSpy perspective. Similarly, a file of another filetype can be opened in another perspective in Eclipse. Additionally, for any active file, you can switch the perspective (*see below*), thus allowing you to edit or process that file in another environment.

There are therefore two main advantage of perspectives:

1. Being able to quickly change the working environment of the active file, and
2. Being able to switch between files without having to open a new development environment (the associated environment is available in a perspective)

Working with the XMLSpy perspective involves the following key procedures, which are described further below:

- Switching to the XMLSpy perspective.
- Setting preferences for the XMLSpy perspective.
- Customizing the XMLSpy perspective.

Switch to the XMLSpy perspective

In Eclipse, select the command **Window | Perspective | Open Perspective | Other**. In the dialog that appears (*screenshot below*), select **XMLSpy**, and click **Open**.

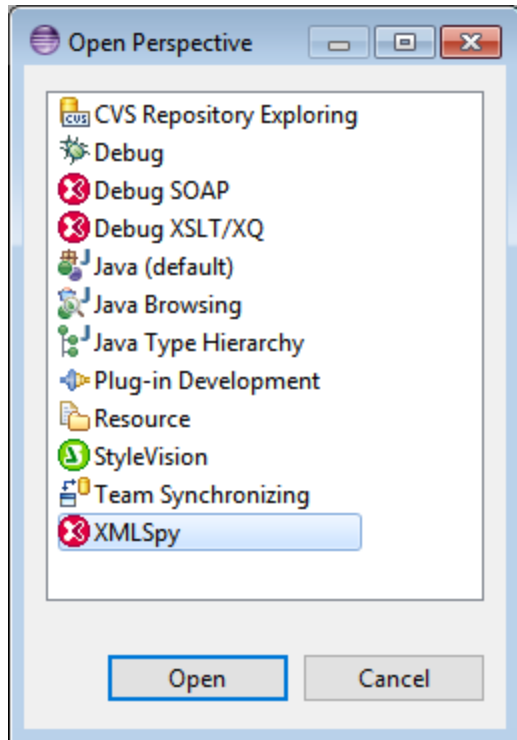

The empty window or the active document will now have the XMLSpy perspective. This is how the user switches the perspective via the menu. To access a perspective faster from another perspective, you can set the required perspective to be listed in the **Open Perspective** submenu, above the **Other** item. This setting is in the customization dialog (see further below).

Perspectives can also be switched when a file is opened or made active. The perspective of the application associated with a file's filetype will be automatically opened when that file is opened for the first time. Before the perspective is switched, a dialog appears asking whether you wish to have the default perspective automatically associated with this filetype. Check the *Do Not Ask Again* option if you wish to associate the perspective with the filetype without having to be prompted each time a file of this filetype is opened and then click **OK**.

Preferences for the XMLSpy perspective

To access the Preferences of a perspective, select the command **Window | Preferences**. In the list of perspectives in the left pane, select XMLSpy, then select the required preferences. Finish by clicking **OK**.

The preferences of a perspective include:

- To automatically switch to the XMLSpy perspective when a file of an associated filetype is opened (see above)
- Options for including or excluding individual XMLSpy toolbars
- Access to XMLSpy options.

Customize the XMLSpy perspective

The customization options enable you to determine what shortcuts and commands are included in the

perspective. To access the Customize Perspective dialog of a perspective, make that perspective the active perspective and select the command **Window | Perspective | Customize Perspective**.

- In the *Toolbar Visibility* and *Menu Visibility* tabs, you can specify which toolbars and menus are to be displayed.
- In the *Action Set Availability* tab, you can add action sets to their parent menus and to the toolbar. If you wish to enable an action group, check its check box.
- In the *Shortcuts* tab of the Customize Perspective dialog, you can set shortcuts for submenus. Select the required submenu in the Submenus combo box. Then select a shortcut category, and check the shortcuts you wish to include for the perspective.

Click **Apply and Close** to complete the customization and for the changes to take effect.

24.3 Other XMLSpy Entry Points in Eclipse

In addition to the XMLSpy perspective, two other entry points in Eclipse can be used to access XMLSpy functionality:

- XMLSpy menu
- XMLSpy toolbar

XMLSpy menu in Eclipse

The **XMLSpy** menu of Eclipse contains XMLSpy commands that provide key XMLSpy functionality. These commands occur in various menus of the standalone version of XMLSpy.

At the bottom of this menu are commands to set the theme of the XMLSpy perspective in Eclipse.

XMLSpy toolbar in Eclipse

The XMLSpy toolbar in Eclipse (*screenshot below*) contains two buttons.



These buttons do the following:

- Open the XMLSpy Help
- Provide access to XMLSpy commands (as an alternative to accessing them from the **XMLSpy** menu, *see above*).

Note: Toolbar commands are not supported. If you have set up a toolbar command in XMLSpy that runs a command or script, then this toolbar command will not be available in the plug-in.

XMLSpy file formats and behavior of Eclipse views

When certain file types recognized by XMLSpy are active (in focus) in Eclipse, the *Elements*, *Attributes*, and *Entities* views appear with a name that is meaningful for that format. For example, when a `.css` file is active, the Elements view has the name *CSS Outline*. The following table illustrates how view names change based on the active file:

| This file format active | Elements view becomes... | Attributes view becomes... | Properties view becomes... |
|---|--------------------------|----------------------------|----------------------------|
| <code>.css</code> | CSS Outline | CSS Properties | HTML Elements |
| <code>.xquery</code> , <code>.xq</code> | XQuery Keywords | XQuery Variables | XQuery Functions |
| <code>.xsd</code> | Components | Details | Facets |

If you close any of these views, you can restore them later using the menu command **Window | Show View**. Note, however, that views are displayed in this menu with their generic name (that is, *Elements*, *Attributes*, and *Entities*). So, for example, in order to restore the view *CSS Outline*, you would select **Show View | Elements**.

As an alternative, reset the XMLSpy perspective to its default values by clicking **Window | Reset Perspective**.

24.4 XMLSpy's Debugger Perspectives

There are two debuggers in the Enterprise edition of XMLSpy (XSLT/XQuery and SOAP), and one debugger in the Professional edition of XMLSpy (XSLT/XQuery). Perspectives for these debuggers are available in Eclipse according to the XMLSpy edition that is currently installed.

To switch to a debugger perspective, select the command **Window | Open Perspective | Other**. In the dialog that pops up (*screenshot below*), select the debugger (for example, Debug XSLT/XQ), and click **OK**.

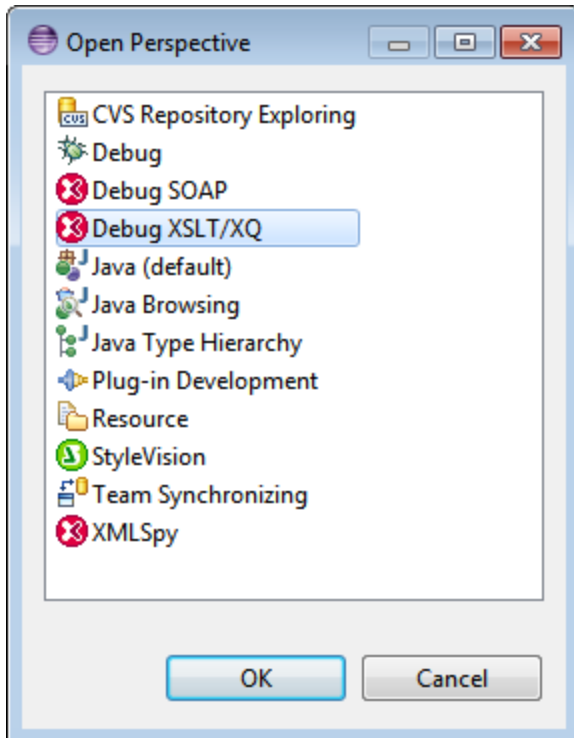

The empty window or the active document will now have the perspective of the selected debugger. This is how the user switches the perspective via the menu. To access a perspective faster from another perspective, the required perspective can be listed in the **Open Perspective** submenu, above the **Other** item; this setting is in the customization dialog.

For a description of how to use the debuggers, see the respective sections in this documentation: XSLT and XQuery, and WSDL and SOAP.

25 Menu Commands

This section contains a complete description of all XMLSpy menu commands. In addition to the general description of a command, we have attempted to explain relevant background where this has been thought to be necessary or of use. If, however, you have a question that is not answered in this documentation, please look up the [FAQs](#) and [Discussion Forums](#) on the [Altova website](#). If you are not able to find a suitable answer at these locations, do not hesitate to contact the [Altova Support Center](#)¹⁰⁸⁸.

Standard Windows commands, such as (**Open**, **Save**, **Cut**, **Copy** and **Paste**) are in the [File](#)⁷⁸² and [Edit](#)⁸⁰³ menus. These menus additionally contain XML- and Internet-related commands.

25.1 File Menu

The **File** menu contains commands for file operations, ordered as in most Windows applications. In addition to the standard [New](#)⁷⁸², [Open](#)⁷⁸⁷, [Save](#)⁷⁹³, [Print](#)⁷⁹⁹, [Print Setup](#)⁸⁰⁰, and [Exit](#)⁸⁰¹ commands, XMLSpy also offers XML-specific and application-specific commands.

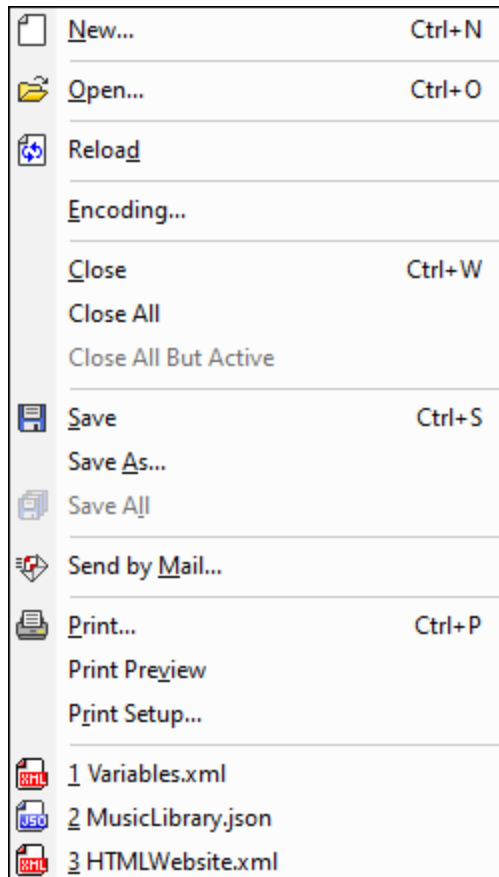

25.1.1 New

This section:

- [Icon and shortcut](#)⁷⁸³
- [Description](#)⁷⁸³
- [Templates for new documents](#)⁷⁸³
- [Assigning a DTD or XML Schema to a new XML document](#)⁷⁸⁴
- [Specifying the root element of a new XML document](#)⁷⁸⁵
- [Assigning an SPS to a new XML document](#)⁷⁸⁶

Icon and shortcut

| | |
|-----------|---|
| Icon: |  |
| Shortcut: | Ctrl+N |

Description

The **New** command is used to create a new document. Clicking **New** opens the Create New Document dialog (*screenshot below*), in which you can select the type of document you wish to create (from among 80+ types by file extension). If the document type you wish to create is not listed in the dialog, select XML and change the file extension when you save the file. Note that you can add new document types to this dialog list using the [Tools | Options | File Types section](#) ¹⁰⁴³.

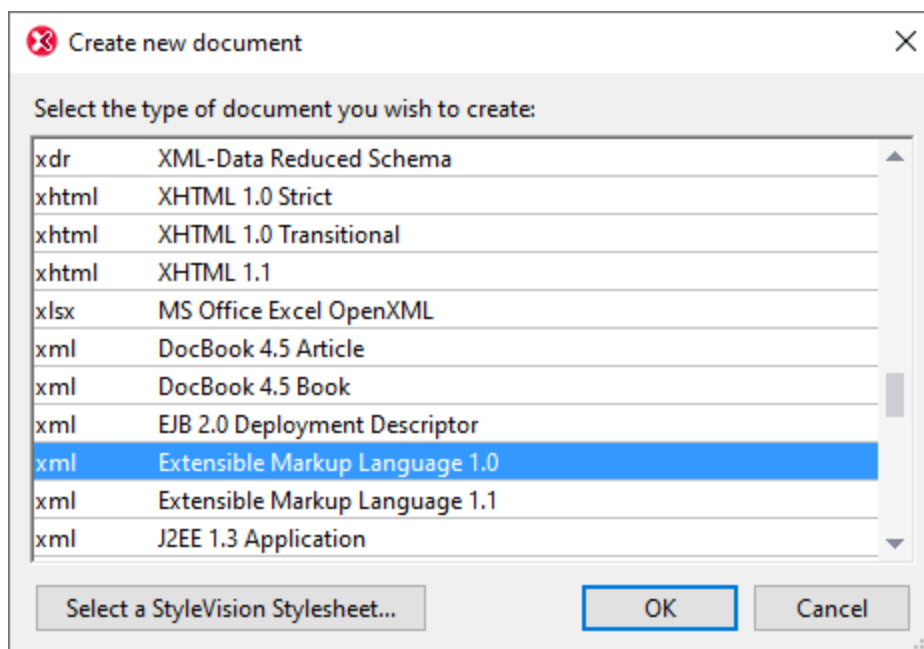

Templates for new documents

The document-type list of the Create New Document dialog can also contain entries for user-defined document templates of any document type. These templates can be opened directly from the Create New Document dialog and edited. To create your own document template so that it appears in the list of document types in the Create New Document dialog, first create the template document and then save it to document templates folder: the `Template` folder of the [application folder](#) ²⁸.

Create a document template as follows:

1. Open the `Template` folder of the [application folder](#) ²⁸ using Windows Explorer or your preferred navigation tool, and select a rudimentary template file from among the files named `new.xxx` (where `.xxx` is a file extension, such as `.xml` or `.xslt`).
2. Open the file in XMLSpy, and modify the file as required. This file will be the template file.

3. After you have finished, select **File | Save as** to save the file back to the `Template` folder with a suitable name, say `MyXMLTemplate.xml`. You now have a document template called `MyXMLTemplate`, which will appear in the list of document types in the Create New Document dialog.

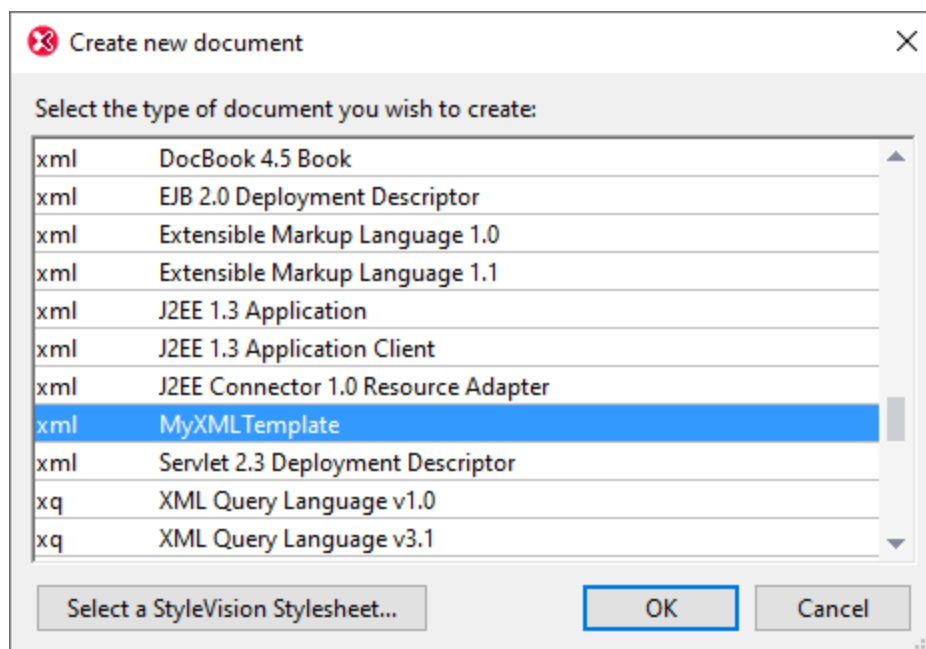

4. To open the template, select **File | New**, and then the template (`my-xml`, in this case).

To delete a document template from the list of document types, delete (or move) the template file from the template folder.

Assigning a DTD or XML Schema to a new XML document

When you create a new document of a certain type (say `.xsd`), then the new document will be created with the necessary schema assignments (DTD or XML Schema)—if these have been defined in the document type's specification. For example, an XHTML 1.0 Strict document will be assigned the DTD <http://www.w3.org/TR/xhtml1/DTD/xhtml1-strict.dtd> since this is the assignment defined in the XHTML specification for XHTML 1.0 Strict documents.

However, not every document type is associated with a specific schema—or can be associated with a schema at all. For example, a text file does not have a schema association. And an XML file can be assigned any schema by which it should be valid. If you are creating a new document for which the schema may be freely chosen (for example, a new XML document), then you are prompted to assign a schema (DTD or XML Schema) to the new document (*screenshot below*). This assignment will be written into the document and the chosen schema will be used from this point onwards for validating the document. Subsequently, you can use the menu command [DTD/Schema | Assign DTD](#)⁸⁶⁸ or [DTD/Schema | Assign Schema](#)⁸⁶⁹ to change the assigned schema.

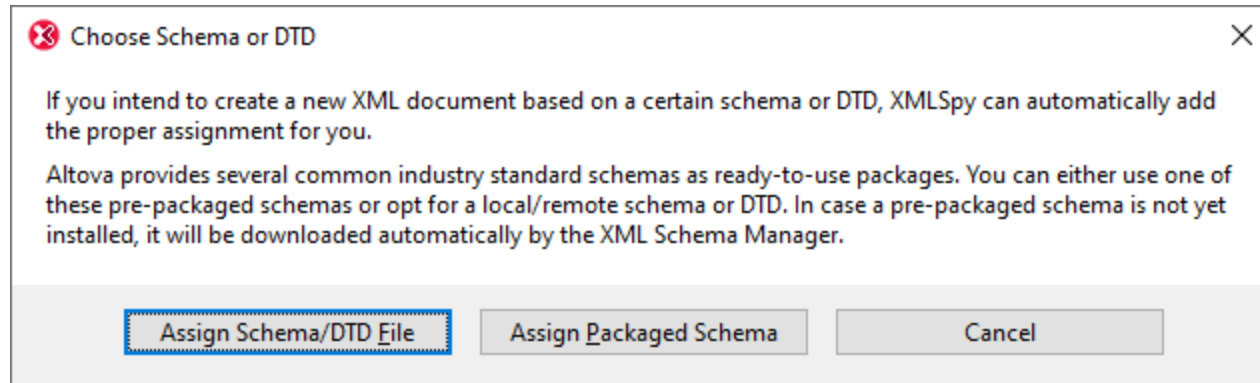

The following options are available:

- *Assign Schema/DTD File*: Browse for the XML Schema or DTD file you want to assign. Note that you can make the assignment in the document a relative or absolute path.
- *Assign Packaged Schema*: Some schemas are each actually a package of schema files rather than a single schema file. The *Assign Packaged Schema* option opens a dialog that lists the schema packages supported by Altova's [Schema Manager](#)³⁰⁷. In this dialog, schemas listed in black have already been installed on your machine, those in blue have not been installed and can be installed by [Schema Manager](#)³⁰⁷. When you select a schema package or one of its schema entry points and click **OK**, the following happens: The schema package will be installed if it has not already been installed. The selected schema package (previously installed or newly installed) will be assigned to the document and will be used from this point onwards for document validation.
- *Cancel*: If a new file is being created, then it is created with no XML Schema or DTD assignment. If the schema assignment is for an already existing document, then the dialog is exited.

Specifying the root element of a new XML document

If an XML Schema is selected as the associated schema of an XML document and if this schema has more than one global element, each of these is a potential root element. In this case, the Select a Root Element dialog (*screenshot below*) pops up, in which you can select which global element is to be the root element of the XML document. In the screenshot below, the `OrgChart` global element is selected.

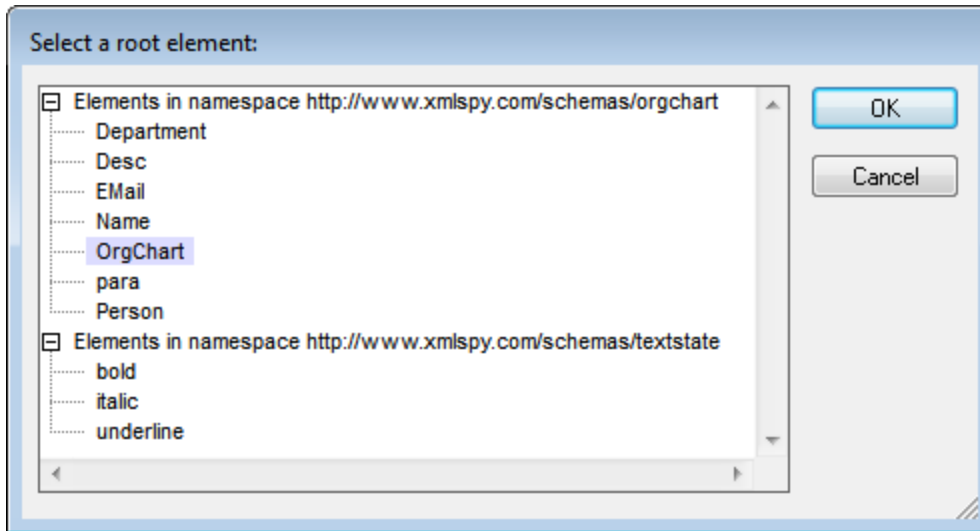

Clicking **OK** now will create a new XML document with this element (`OrgChart`) as its root element.

Assigning an SPS to a new XML document

When a new XML document is created, you can associate a StyleVision Power Stylesheet (`.sps` file) to view the document in Authentic View. In the Create New Document dialog (see *first screenshot in this section*), when you click the **Select StyleVision Stylesheet**, the Create New Document dialog (shown below) appears.

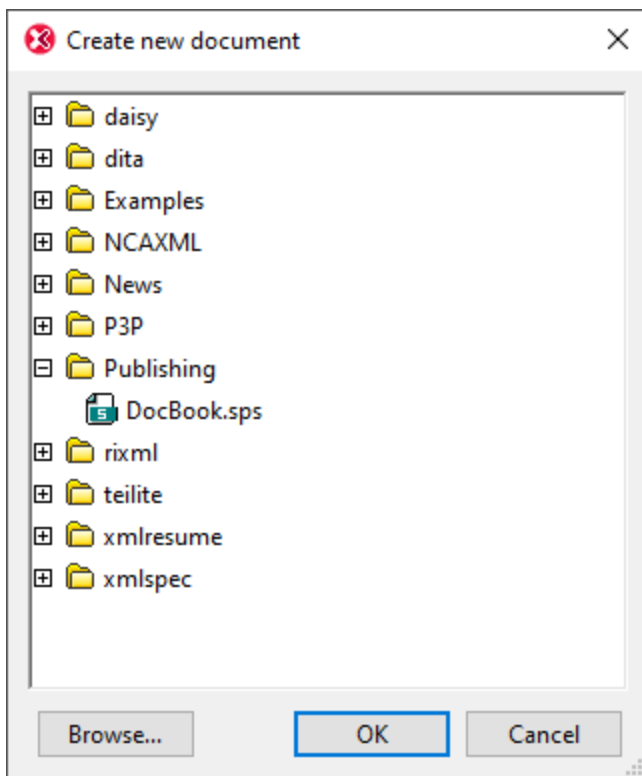

You can browse for the required SPS in the folder tabs, or you can click the **Browse** button to navigate for and select the SPS.

25.1.2 Open

Icon and shortcut

| | |
|------------------|---|
| <i>Icon:</i> |  |
| <i>Shortcut:</i> | Ctrl+O |

Description

The **Open** command pops up the familiar Windows Open dialog, and allows you to open any XML-related document or text document. In the Open dialog, you can select more than one file to open. Use the Files of Type combo box to restrict the kind of files displayed in the dialog box. (The list of available file types can be configured in the File Types section of the Options dialog ([Tools | Options](#)¹⁰⁴³)).) When an XML file is opened, it is checked for well-formedness. If the file is not well-formed, you will get a file-not-well-formed error. Fix the error and select the menu command [XML | Check Well-Formedness \(F7\)](#)⁸⁵⁶ to recheck. If you have opted for automatic [validation upon opening](#)¹⁰⁴¹ and the file is invalid, you will get an error message. Fix the error and select the menu command [XML | Validate XML \(F8\)](#)⁸⁶³ to revalidate.

▼ Selecting and saving files via URLs and Global Resources

In several File Open and File Save dialogs, you can choose to select the required file or save a file via a URL or a global resource (see *screenshot below*). Click **Switch to URL** or **Global Resource** to go to one of these selection processes.

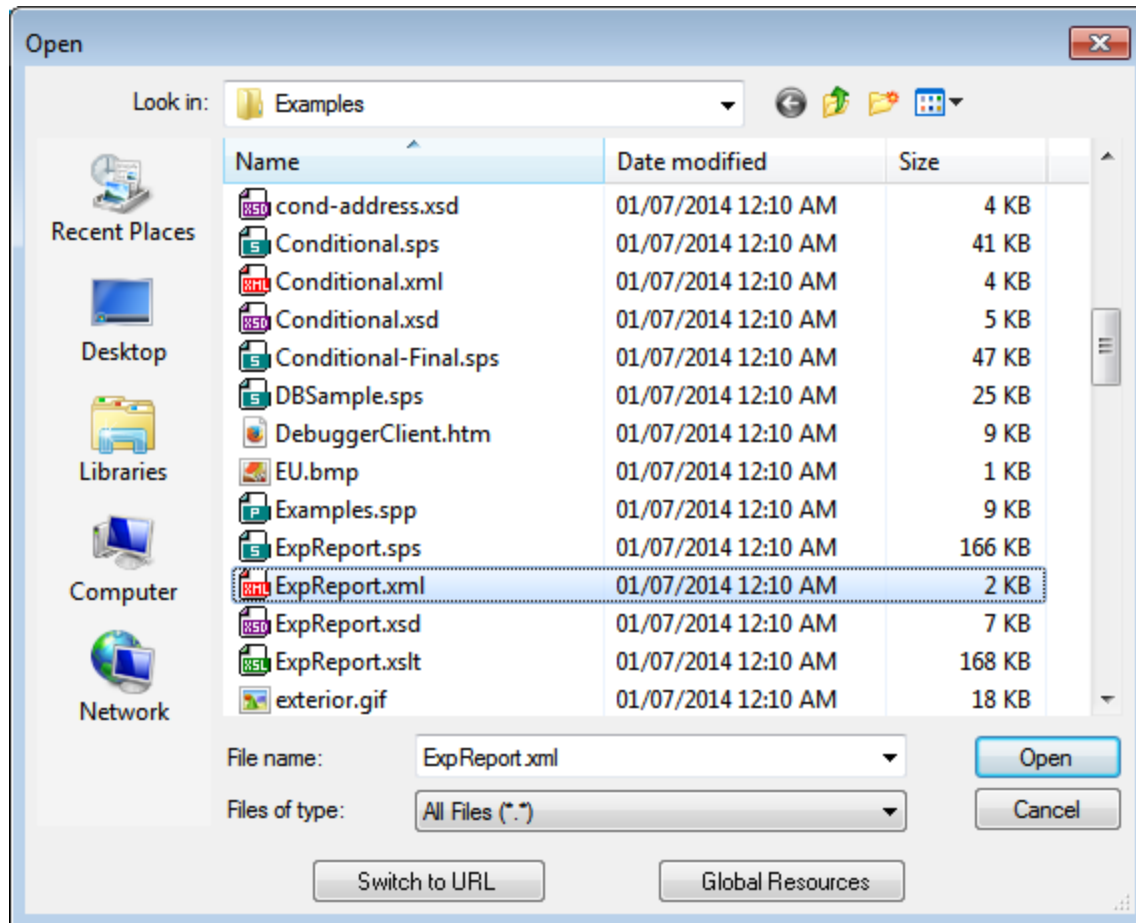

Selecting files via URLs

To select a file via a URL (either for opening or saving), do the following:

1. Click the **Switch to URL** command. This switches to the URL mode of the Open or Save dialog (the screenshot below shows the Open dialog).

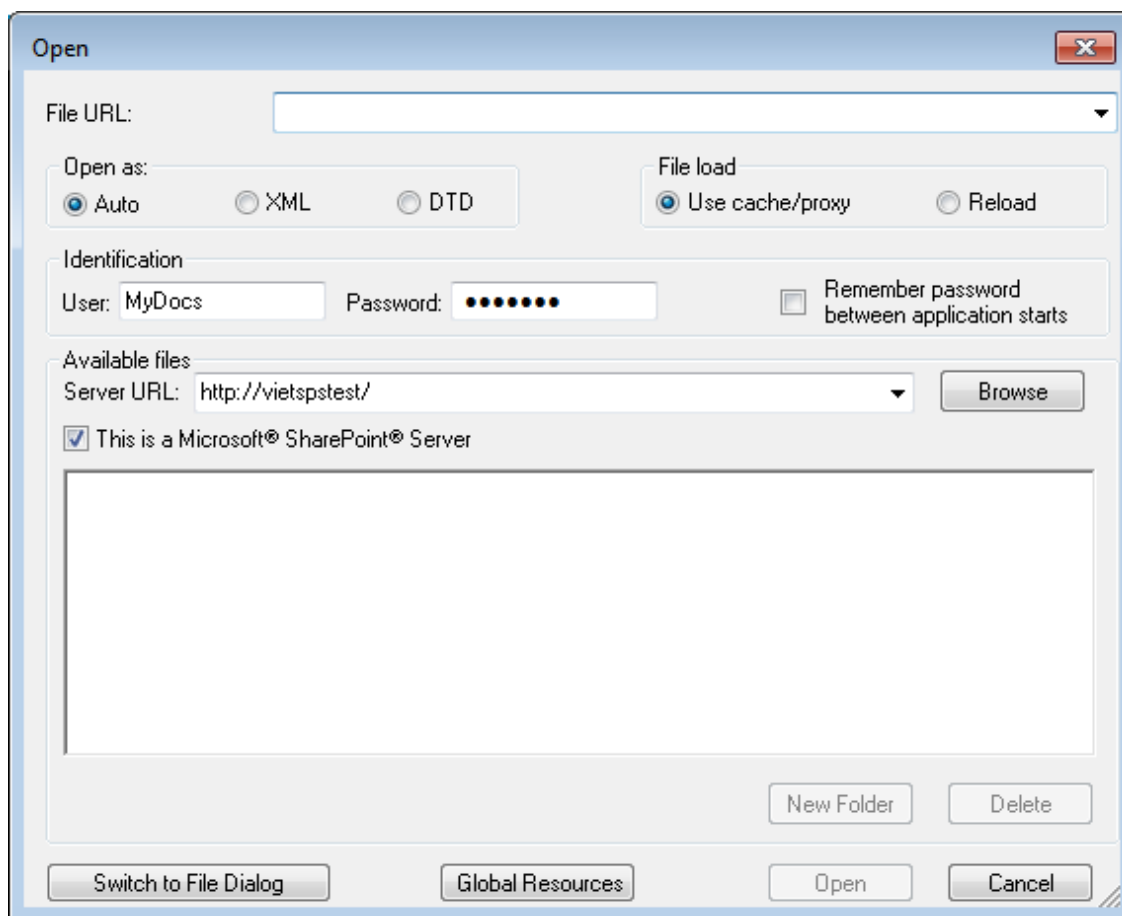

2. Enter the URL you want to access in the *Server URL* field (*screenshot above*). If the server is a Microsoft® SharePoint® Server, check the *Microsoft® SharePoint® Server* check box. See the Microsoft® SharePoint® Server Notes below for further information about working with files on this type of server.
3. If the server is password protected, enter your User-ID and password in the *User* and *Password* fields.
4. Click **Browse** to view and navigate the directory structure of the server.
5. In the folder tree, browse for the file you want to load and click it.

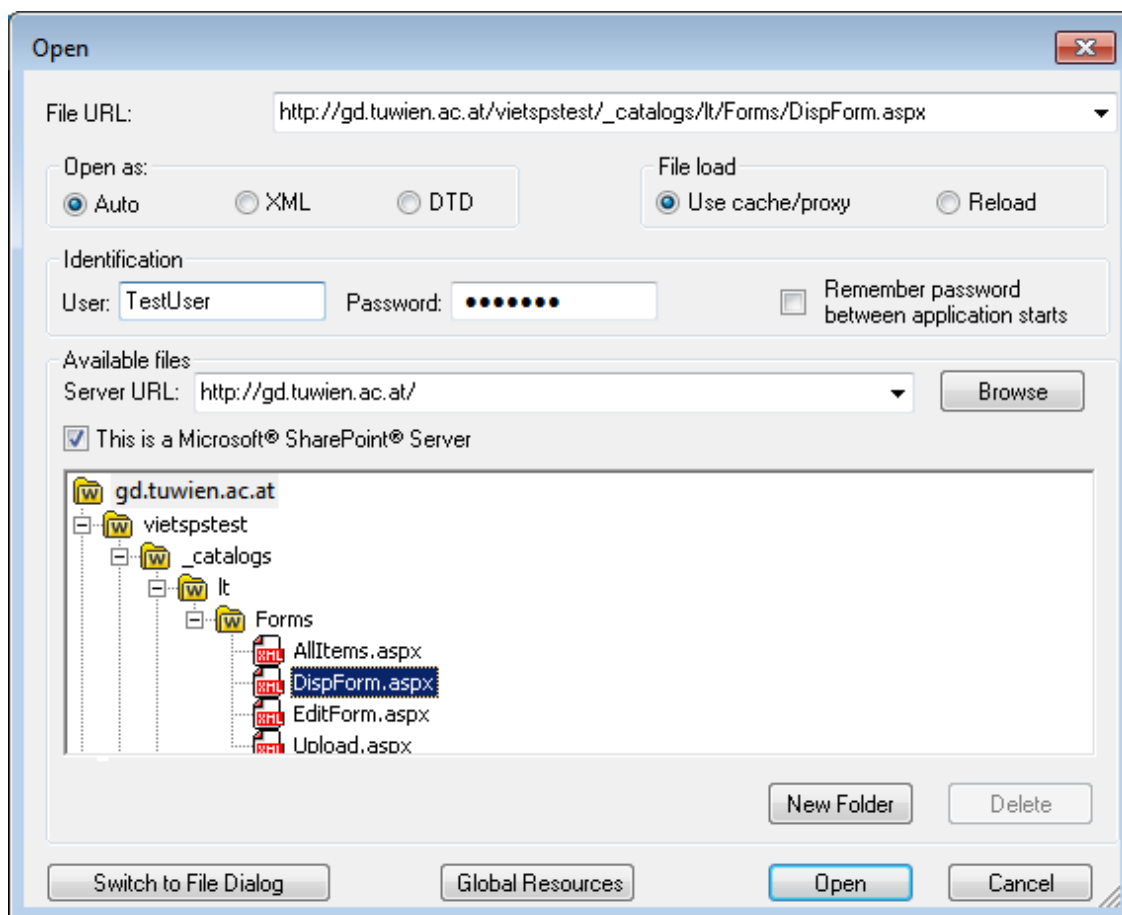

The file URL appears in the File URL field (see screenshot above). The **Open** or **Save** button only becomes active at this point.

6. Click **Open** to load the file or **Save** to save it.

Note the following:

- The Browse function is only available on servers which support WebDAV and on Microsoft SharePoint Servers. The supported protocols are FTP, HTTP, and HTTPS.
- To give you more control over the loading process when opening a file, you can choose to load the file through the local cache or a proxy server (which considerably speeds up the process if the file has been loaded before). Alternatively, you may want to reload the file if you are working, say, with an electronic publishing or database system; select the **Reload** option in this case.

▼ Microsoft® SharePoint® Server Notes

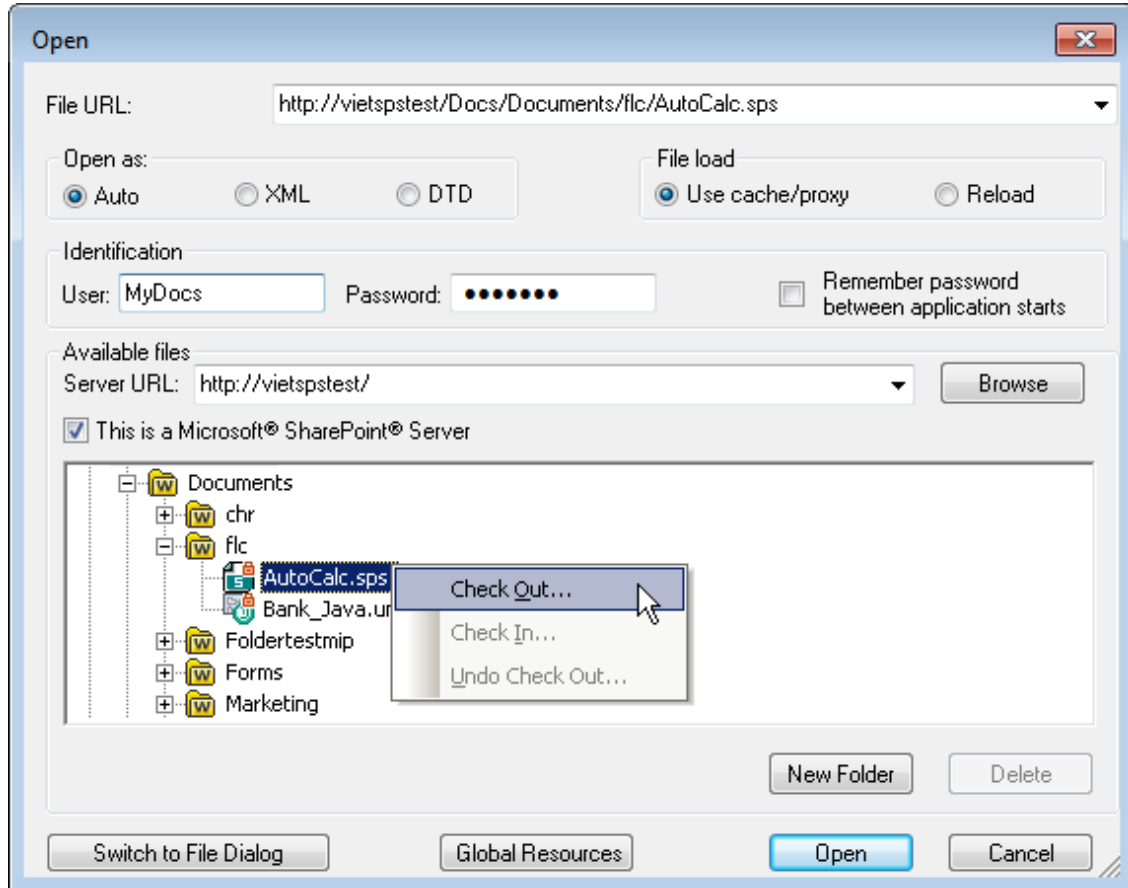

Note the following points about files on Microsoft® SharePoint® Servers:

- In the directory structure that appears in the Available Files pane (screenshot below), file icons have symbols that indicate the check-in/check-out status of files.



Right-clicking a file pops up a context menu containing commands available for that file (screenshot above).

- The various file icons are shown below:

| | |
|---|---|
|  | Checked in. Available for check-out. |
|  | Checked out by another user. Not available for check-out. |
|  | Checked out locally. Can be edited and checked-in. |

- After you check out a file, you can edit it in your Altova application and save it using **File | Save (Ctrl+S)**.
- You can check-in the edited file via the context menu in the Open URL dialog (see screenshot above), or via the context menu that pops up when you right-click the file tab in the Main Window of your application (screenshot below).



- When a file is checked out by another user, it is not available for check out.
- When a file is checked out locally by you, you can undo the check-out with the Undo Check-Out

- command in the context menu. This has the effect of returning the file unchanged to the server.
- If you check out a file in one Altova application, you cannot check it out in another Altova application. The file is considered to be already checked out to you. The available commands at this point in any Altova application supporting Microsoft® SharePoint® Server will be: **Check In** and **Undo Check Out**.

▼ Opening and saving files via Global Resources

To open or save a file via a global resources, click **Global Resource**. This pops up a dialog in which you can select the global resource. These dialogs are described in the section, [Using Global Resources](#)⁷⁰⁸. For a general description of Global Resources, see the [Global Resources](#)⁶⁹⁶ section in this documentation.

25.1.3 Reload

Icon

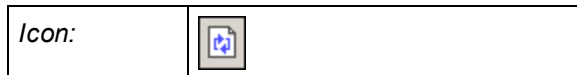

Description

Reloads any open documents that have modified outside XMLSpy. If one or more documents is modified outside XMLSpy, a prompt appears asking whether you wish to reload the modified document/s. If you choose to reload, then any changes you may have made to the file since the last time it was saved will be lost.

25.1.4 Encoding

The **Encoding** command lets you: (i) view the current encoding of the active document (XML or non-XML), and (ii) select a different encoding with which the active document will be saved the next time.

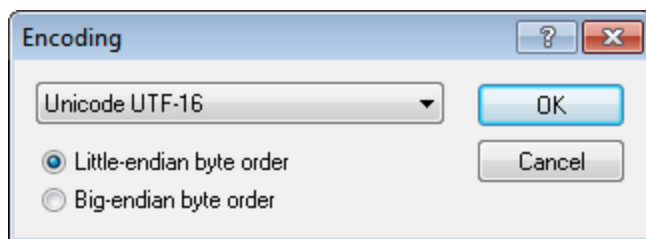

In XML documents, if you select a different encoding than the one currently in use, the encoding attribute in the XML declaration will be modified accordingly. For two-byte and four-byte character encodings (UTF-16, UCS-2, and UCS-4) you can also specify the byte-order to be used for the file. Another way to change the encoding of

an XML document is to directly edit the encoding attribute of the document's XML declaration. Default encodings for existing and new XML and non-XML documents can be set in the [Encoding section of the Options dialog](#)¹⁰⁴⁶.

Note: When saving a document, XMLSpy automatically checks the encoding specification and enables you to select the required encoding via the Encoding dialog. If your document contains characters that cannot be represented in the selected encoding and you attempt to save the file, you will get a warning message to this effect.

25.1.5 Close, Close All, Close All But Active

Close

The **Close** command closes the active document window. If the file was modified (indicated by an asterisk * after the file name in the title bar), you will be asked if you wish to save the file first.

Close All



The **Close All** command closes all open document windows. If any document has been modified (indicated by an asterisk * after the file name in the title bar), you will be asked if you wish to save the file first.

Close All But Active

The **Close All But Active** command closes all open document windows except the active document window. If any document has been modified (indicated by an asterisk * after the file name in the title bar), you will be asked if you wish to save the file first.

25.1.6 Save, Save As, Save All

Icons and shortcuts

| Command | Icon | Shortcut |
|----------|---|----------|
| Save |  | Ctrl+S |
| Save All |  | |

Save

The **Save** command (**Ctrl+S**) saves the contents of the active document to the file from which it has been opened. When saving a document, the file is automatically [checked for well-formedness](#)⁸⁵⁶. The file will also be validated automatically if this option has been set in the File section of the Options dialog (**Tools | Options**¹⁰⁴¹). The XML declaration is also checked for the [encoding](#)¹⁰⁴⁶ specification, and this encoding is applied to the document when the file is saved.

Save As

The **Save As** command pops up the familiar Windows Save As dialog box, in which you enter the name and location of the file you wish to save the active file as. The same checks and validations occur as for the **Save** command.

Save All

The **Save All** command saves all modifications that have been made to any open documents. The command is useful if you edit multiple documents simultaneously. If a document has not been saved before (for example, after being newly created), the Save As dialog box is presented for that document.

▼ Selecting and saving files via URLs and Global Resources

In several File Open and File Save dialogs, you can choose to select the required file or save a file via a URL or a global resource (see *screenshot below*). Click **Switch to URL** or **Global Resource** to go to one of these selection processes.

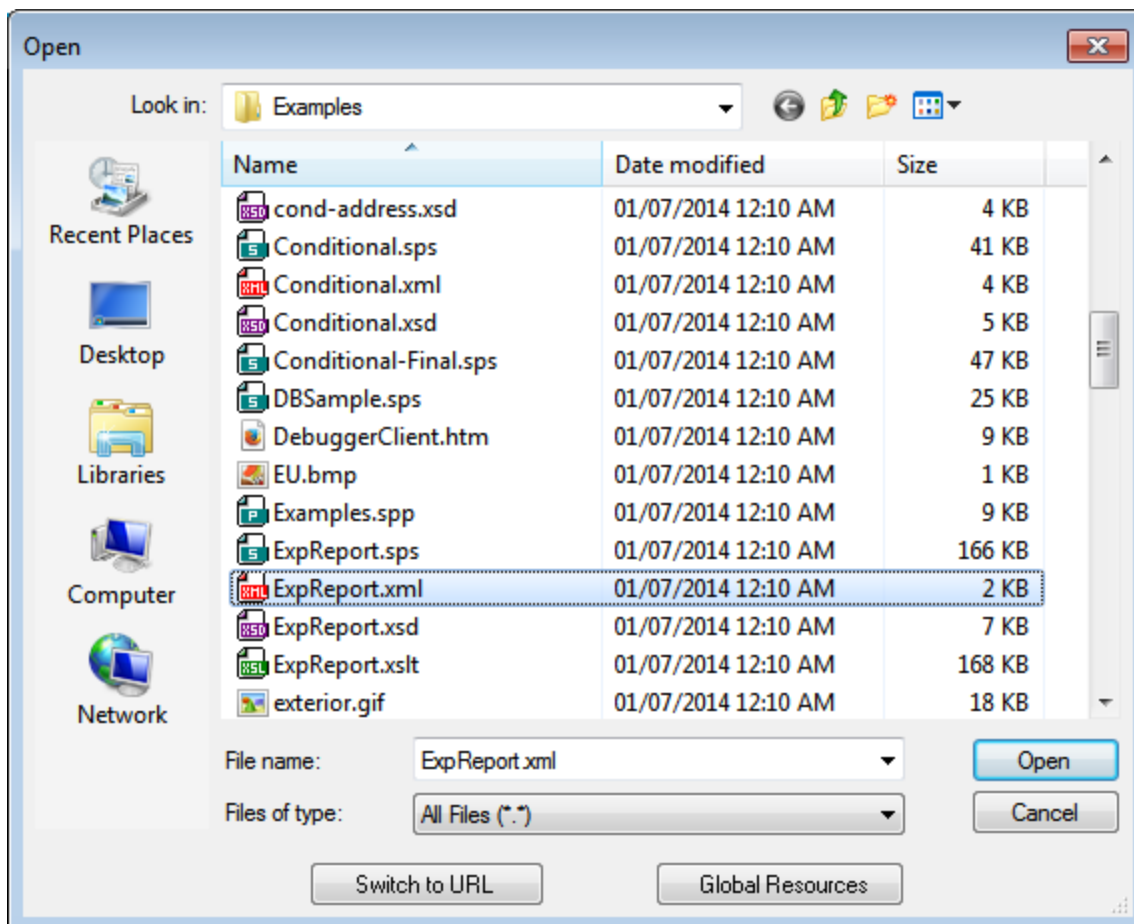

Selecting files via URLs

To select a file via a URL (either for opening or saving), do the following:

1. Click the **Switch to URL** command. This switches to the URL mode of the Open or Save dialog (*the screenshot below shows the Open dialog*).

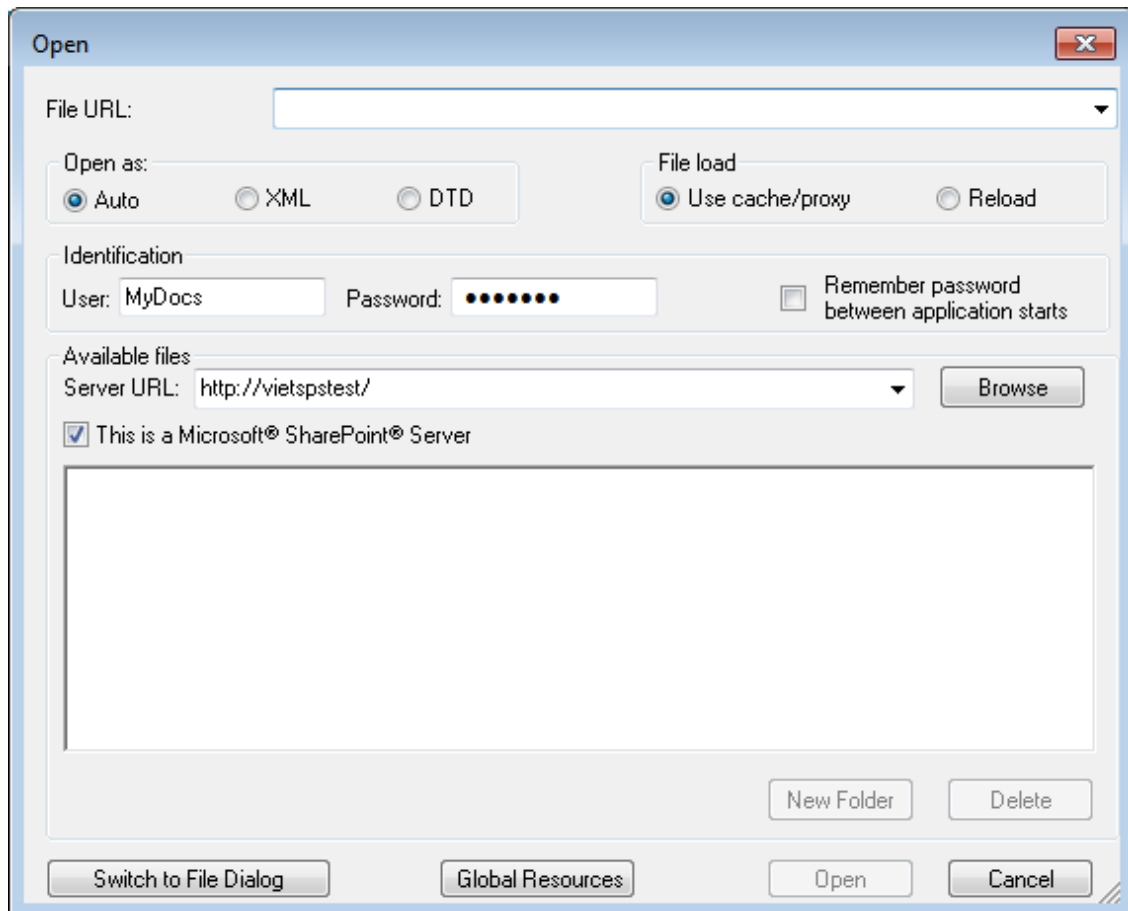

2. Enter the URL you want to access in the *Server URL* field (*screenshot above*). If the server is a Microsoft® SharePoint® Server, check the *Microsoft® SharePoint® Server* check box. See the Microsoft® SharePoint® Server Notes below for further information about working with files on this type of server.
3. If the server is password protected, enter your User-ID and password in the *User* and *Password* fields.
4. Click **Browse** to view and navigate the directory structure of the server.
5. In the folder tree, browse for the file you want to load and click it.

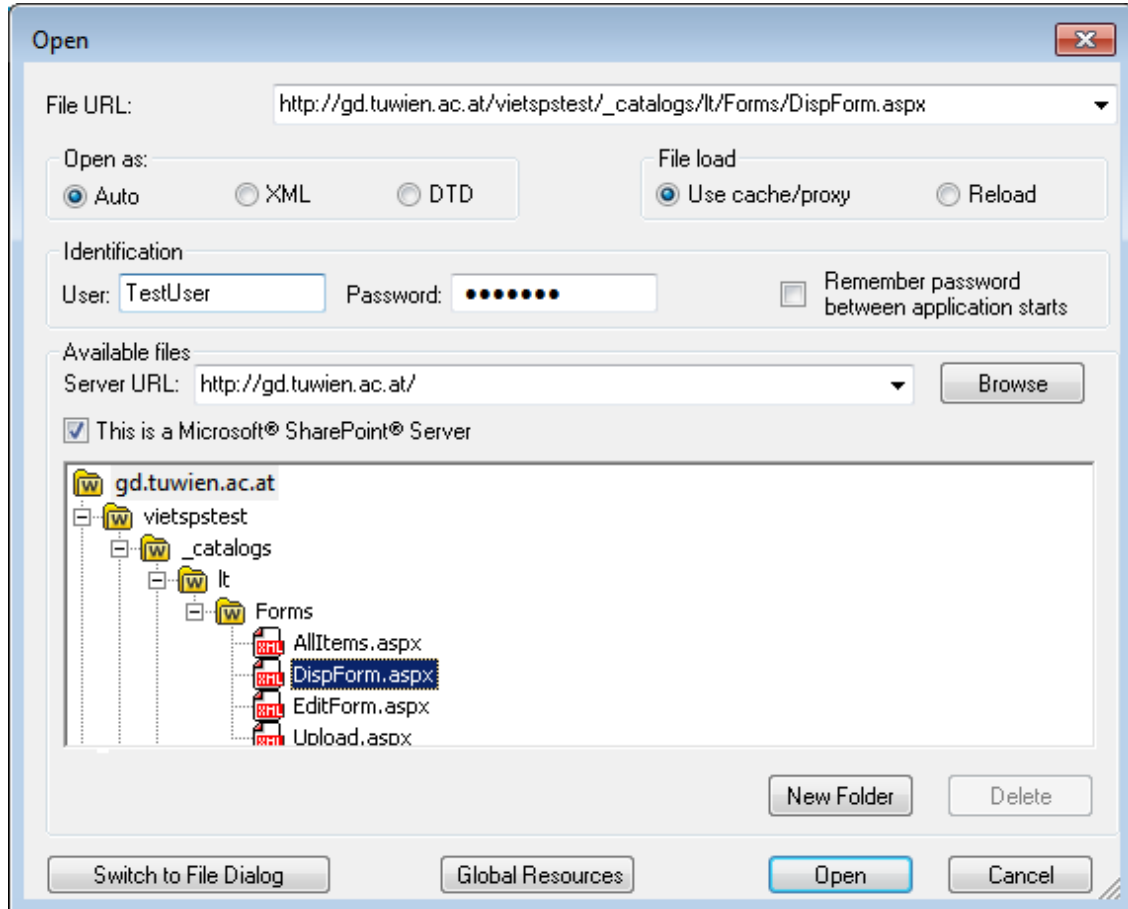

The file URL appears in the File URL field (see screenshot above). The **Open** or **Save** button only becomes active at this point.

6. Click **Open** to load the file or **Save** to save it.

Note the following:

- The Browse function is only available on servers which support WebDAV and on Microsoft SharePoint Servers. The supported protocols are FTP, HTTP, and HTTPS.
- To give you more control over the loading process when opening a file, you can choose to load the file through the local cache or a proxy server (which considerably speeds up the process if the file has been loaded before). Alternatively, you may want to reload the file if you are working, say, with an electronic publishing or database system; select the **Reload** option in this case.

▼ Microsoft® SharePoint® Server Notes

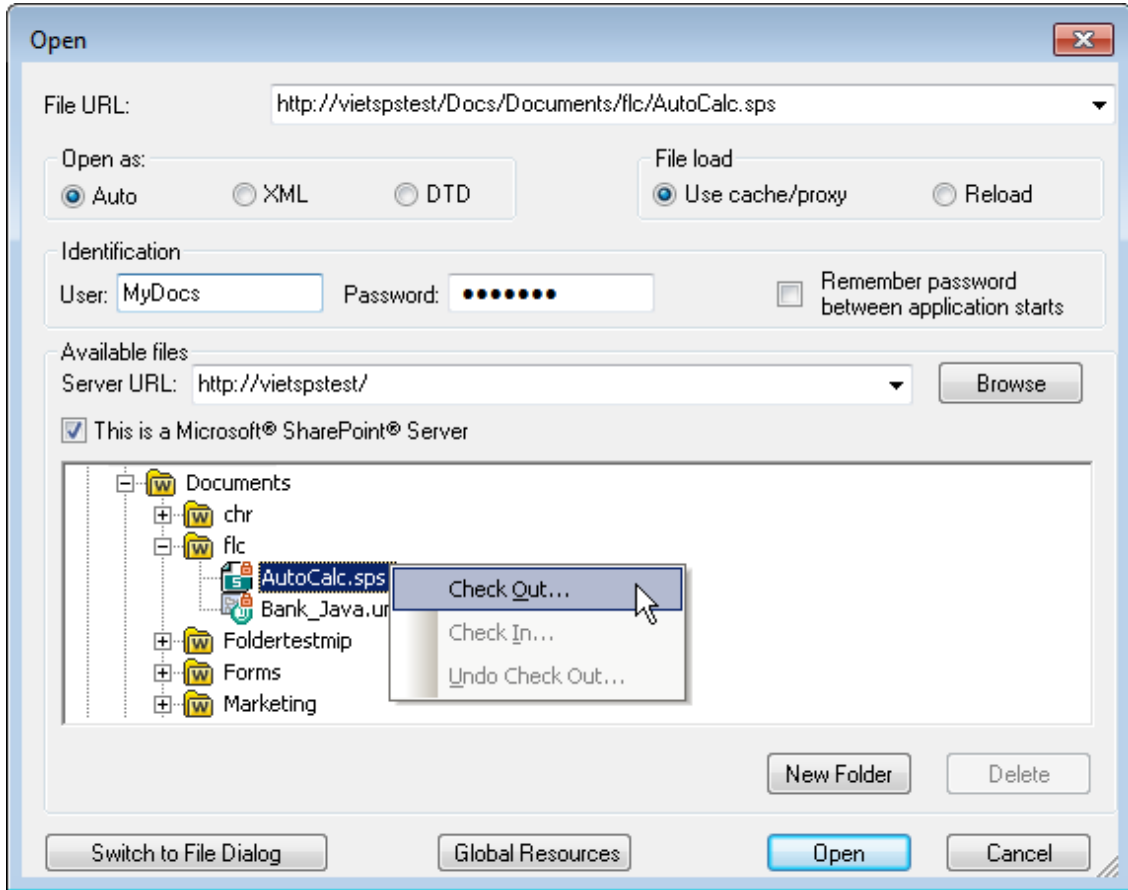

Note the following points about files on Microsoft® SharePoint® Servers:

- In the directory structure that appears in the Available Files pane (screenshot below), file icons have symbols that indicate the check-in/check-out status of files.



Right-clicking a file pops up a context menu containing commands available for that file (screenshot above).

- The various file icons are shown below:

| | |
|---|---|
|  | Checked in. Available for check-out. |
|  | Checked out by another user. Not available for check-out. |
|  | Checked out locally. Can be edited and checked-in. |

- After you check out a file, you can edit it in your Altova application and save it using **File | Save (Ctrl+S)**.
- You can check-in the edited file via the context menu in the Open URL dialog (see screenshot above), or via the context menu that pops up when you right-click the file tab in the Main Window of your application (screenshot below).

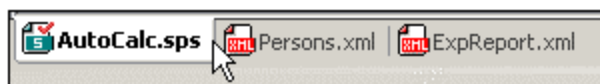

- When a file is checked out by another user, it is not available for check out.
- When a file is checked out locally by you, you can undo the check-out with the Undo Check-Out

- command in the context menu. This has the effect of returning the file unchanged to the server.
- If you check out a file in one Altova application, you cannot check it out in another Altova application. The file is considered to be already checked out to you. The available commands at this point in any Altova application supporting Microsoft® SharePoint® Server will be: **Check In** and **Undo Check Out**.

▼ Opening and saving files via Global Resources

To open or save a file via a global resources, click **Global Resource**. This pops up a dialog in which you can select the global resource. These dialogs are described in the section, [Using Global Resources](#)⁷⁰⁸. For a general description of Global Resources, see the [Global Resources](#)⁶⁹⁶ section in this documentation.

25.1.7 Send by Mail

Icon



Description

The **Send by Mail** command lets you send XML document/s or selections from an XML document by e-mail. Depending on what kind it is, a document or selection can be sent as an attachment, content, or as a link. See the table below for details.

| What can be sent | How it can be sent |
|-------------------------------------|--|
| Active XML document | As e-mail attachment |
| Selection in active XML document | As e-mail attachment or e-mail content |
| One or more files in Project window | As e-mail attachment |
| One or more URLs in Project window | As e-mail attachment or link |

When the **Send by Mail** command is invoked on a selection in the active XML document, the Send by Mail dialog (*screenshot below*) pops up and offers the sending options shown in the screenshot. If the **Send by Mail** command is invoked with no text selected in the active file, then the *Whole File* radio button (*refer to screenshot above*) is the only option that is enabled; the other options are disabled.

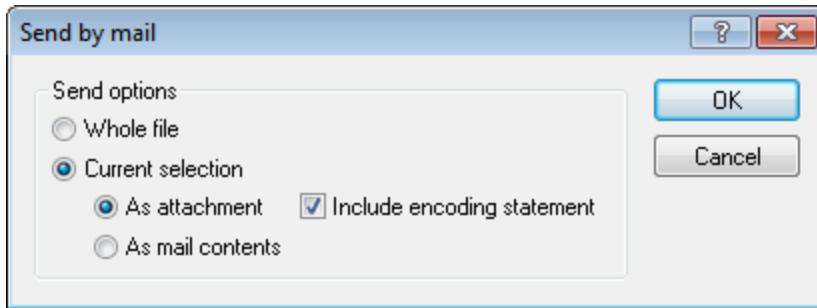

Since files sent from the Project window are always sent as e-mail attachments only, the Send by Email dialog is skipped and an e-mail is opened that has the selected file/s as attachments. URLs in the project window can be sent as an attachment or as a link (*see screenshot below*). Select how the URL is to be sent and click **OK**.

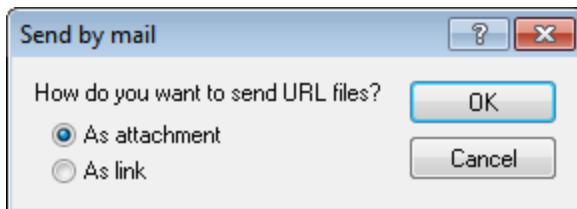

25.1.8 Print

Icon and shortcut

| | |
|------------------|---|
| <i>Icon:</i> |  |
| <i>Shortcut:</i> | Ctrl+P |

Description

The **Print** command opens the printer's dialog for selecting print options.

In Grid View, the command opens a Print options dialog (*screenshot below*). Clicking **Print** in this dialog takes you to the printer's dialog for selecting print options (see the [Print Setup](#)⁸⁰⁰ command).

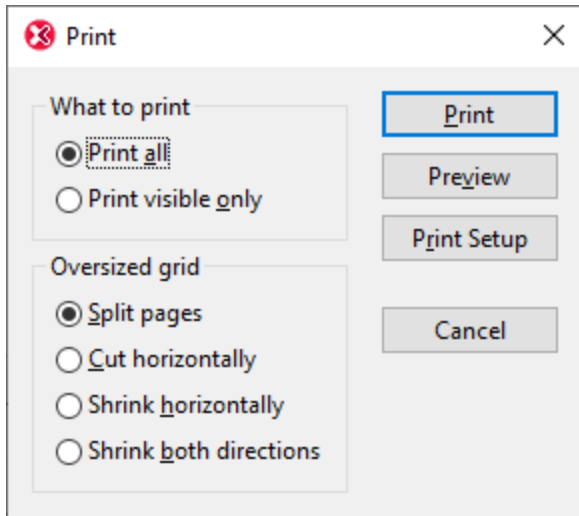

The available options for Grid View printing are described below:

- *What to print*: Whether the current selection or the entire document is to be printed.
- *Oversized grid*: Here you can select what to do if contents are wider than the page: (i) *Split pages* prints the entire document at normal size, splitting contents over pages both horizontally and vertically. The pages could then be glued together to form a poster. (ii) *Cut horizontally* prints only the first, left-hand page of the print area. The area that overflows horizontally is not printed. This option is useful if most of the important information in your Grid View of the document is contained on the left side. (iii) *Shrink horizontally* reduces the size of the output (proportionally) until it fits horizontally on the page; the document may run on for several pages. (iv) *Shrink both directions* option shrinks the document in both directions until it fits exactly on one sheet.
- The **Print** button takes you to the printer's dialog for selecting print options.
- The **Preview** button opens a print preview window that lets you view the final output before committing it to paper.
- The **Print Setup** button opens the Print Setup dialog box and allows you to adjust the paper format, orientation, and other printer options for this print job only. Also see the [Print Setup](#)⁸⁰⁰ command.

Note: You can change column widths in Grid View to optimize the print output.

Program logo

If you have a purchased license, you can turn off the program logo, copyright notice, and registration details when printing a document from XMLSpy. This option is available in the [View section of the Options dialog](#)¹⁰⁵⁵.

25.1.9 Print Preview, Print Setup

Print Preview

The **Print Preview** command clicked in Text View, Authentic View, and Browser View opens a print preview of the currently active document. From Grid View and Schema View, it opens the Print dialog box, in which you can select print options and then click the **Preview** button to get the print preview.

In Print Preview mode, the Print Preview toolbar at top left of the preview window provides print- and preview-related options. The preview can be magnified or miniaturized using the the **Zoom In** and **Zoom Out** buttons. When the page magnification is such that an entire page length fits in a preview window, then the **One Page / Two Page** button toggles the preview to one or two pages at a time. The **Next Page** and **Previous Page** buttons can be used to navigate among the pages. The toolbar also contains buttons to print all pages and to close the preview window.

Note: To enable background colors and images in Print Preview, do the following: (i) In the **Tools** menu of Internet Explorer, click **Internet Options**, and then click the Advanced tab; (ii) In the Settings box, under Printing, select the *Print background colors and images* check box, and (iii) Then click **OK**.

Print Setup

The **Print Setup** command, displays the printer-specific Print Setup dialog box, in which you specify such printer settings as paper format and page orientation. These settings are applied to all subsequent print jobs.

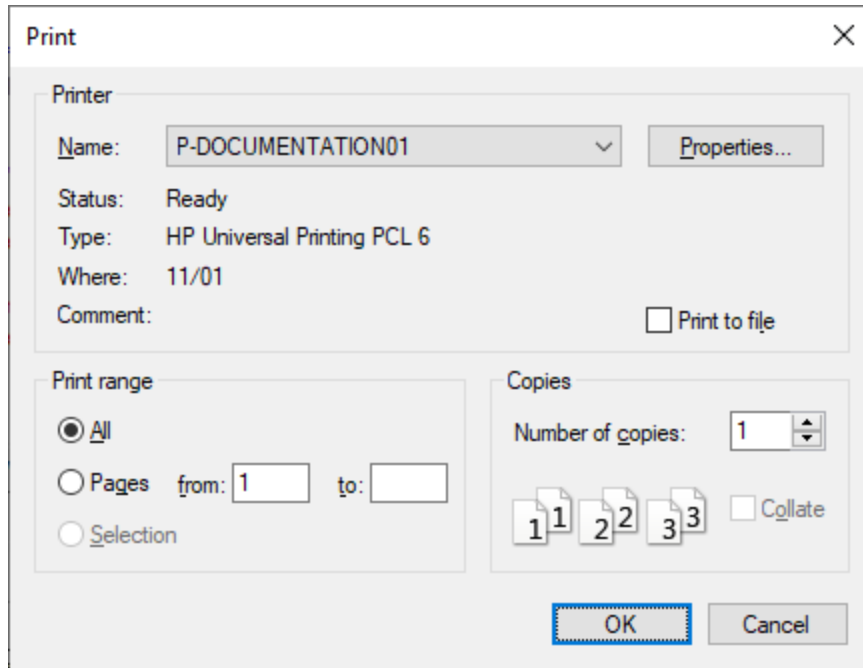

25.1.10 Recent Files, Exit

Recent Files

At the bottom of the **File** menu is a list of the nine most recently used files, with the most recently opened file shown at the top of the list. You can open any of these files by clicking its name. To open a file in the list using the keyboard, press **Alt+F** to open the **File** menu, and then press the number of the file you want to open.

Exit

Quits XMLSpy. If you have any open files with unsaved changes, you are prompted to save these changes. XMLSpy also saves modifications to program settings and information about the most recently used files.

25.2 Edit Menu

The **Edit** menu contains commands for editing documents in XMLSpy. These include the familiar [Undo](#)⁸⁰⁴, [Redo](#)⁸⁰⁴, [Cut](#)⁸⁰⁴, [Copy](#)⁸⁰⁴, [Paste](#)⁸⁰⁴, [Delete](#)⁸⁰⁴, [Select All](#)⁸¹², [Find](#)⁸¹², [Find Next](#)⁸¹² and [Replace](#)⁸¹⁸ commands.

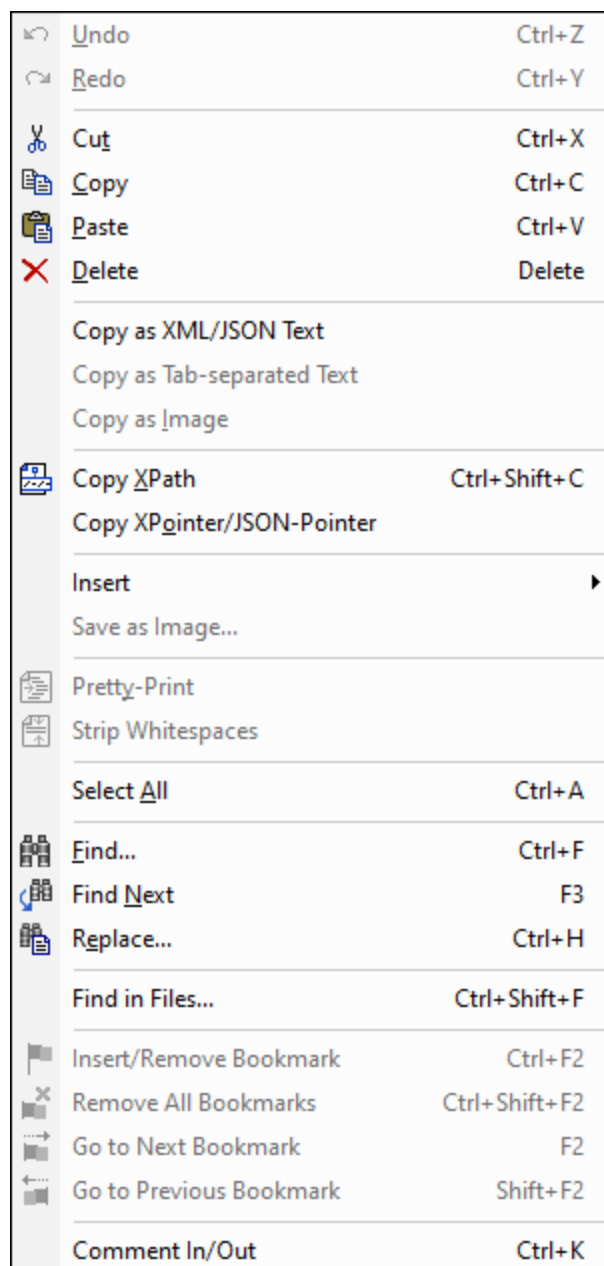



XMLSpy also offers special commands to:

- [copy a selection to the clipboard as XML text](#)⁸⁰⁵,
- [copy as tab/separated text](#)⁸⁰⁶

- [copy an XPath selector to the selected item](#)⁸⁰⁷ to the clipboard.
- insert and remove bookmarks, and to navigate to bookmarks.

25.2.1 Undo, Redo

Icons and shortcuts

| Command | Icon | Shortcut |
|---------|---|----------|
| Undo |  | Ctrl+Z |
| Redo |  | Ctrl+Y |

Undo





The **Undo** command contains support for unlimited levels of Undo. Every action can be undone and it is possible to undo one command after another. The Undo history is retained after using the **Save** command, enabling you go back to the state the document was in before you saved your changes. You can step backwards and forwards through this history using the **Undo** and **Redo** commands (see *Redo command below*).

Redo

The **Redo** command allows you to redo previously undone commands, thereby giving you a complete history of work completed. You can step backwards and forwards through this history using the **Undo** and **Redo** commands.

25.2.2 Cut, Copy, Paste, Delete

Icons and shortcuts

| Command | Icon | Shortcut |
|---------|---|---------------------|
| Cut |  | Ctrl+X or Shift+Del |
| Copy |  | Ctrl+C |
| Paste |  | Ctrl+V |
| Delete |  | Del |

Cut

The **Cut** command copies the selected text or items to the clipboard and deletes them from their present location.

Copy

The **Copy** command copies the selected text or items to the clipboard. This can be used to duplicate data within XMLSpy or to move data to another application.

Note: When copying from Grid View, the selection is copied using one of two methods: [Copy as XML Text](#)⁸⁰⁵ and [Copy as Tab-Separated Text](#)⁸⁰⁶. The former copies the selection as XML text; the latter copies the selection as a table. Which of these two methods is used when the **Copy** command is invoked is specified in the [Editing section of the Tools | Options dialog](#)¹⁰⁴⁷.

Paste

The **Paste** command inserts the contents of the clipboard at the current cursor position.

Delete

The **Delete** command deletes the currently selected text or items without placing them in the clipboard.

25.2.3 Copy as XML/JSON Text

The **Copy as XML/JSON Text** command copies XML or JSON data from Grid View as XML text (*shown in the listing below*) or JSON text. The text will be copied to the clipboard with its markup, and can be pasted to other document locations. Note that this command is available in Grid View only.

```
<row>
  <para align="left">
    <bold>Check the FAQ</bold>
  </para>
  <para>
    <link mode="internal">
      <link_section>support</link_section>
      <link_subsection>faq2020</link_subsection>
      <link_text>XMLSPY 2020 FAQ</link_text>
    </link>
    <link mode="internal">
      <link_section>support</link_section>
      <link_subsection>faq2021</link_subsection>
      <link_text>XMLSPY 2021 FAQ</link_text>
    </link>
  </para>
</row>
```

The formatting of the text follows the currently active pretty-printing settings, which are specified in the [Options dialog](#)¹⁰⁴⁸ (**Tools | Options**). The same effect can be obtained by switching to Text View and copying an XML text fragment with **Ctrl+C** (**Edit | Copy**).

25.2.4 Copy as Tab-Separated Text

The **Copy as Tab-separated Text** command is enabled only when the selection is a range of cells in the Table Display of [XML Grid View](#)¹⁶³ and [JSON Grid View](#)¹⁶⁷. It can be used to copy table-like data in tabular form and to spreadsheet applications.

The screenshots below show how two rows in Table Display are copied as tab-separated text.

| <> expense-item (4) | = type | = expto | <> Date | <> expense |
|---------------------|---------|-------------|------------|------------|
| 1 | Lodging | Sales | 2003-01-01 | 122.11 |
| 2 | Lodging | Development | 2003-01-02 | 122.12 |

The next two screenshots below show the data pasted as tab-separated text into a Microsoft Excel document and a Notepad document, respectively

| | A | B | C | D | E |
|---|---------|-------------|----------|--------|---|
| 1 | Lodging | Sales | 1/1/2003 | 122.11 | |
| 2 | Lodging | Development | 1/2/2003 | 122.12 | |
| 3 | | | | | |

Notice that while Excel (*screenshot above*) automatically formats each cell on the basis of the text's lexical form, Notepad (*screenshot below*) pastes all cell text as strings.

| *Untitled - Notepad | | | | |
|---------------------|-------------|--------|------------|--------|
| File | Edit | Format | View | Help |
| Lodging | Sales | | 2003-01-01 | 122.11 |
| Lodging | Development | | 2003-01-02 | 122.12 |

For more information, see the sections [Table Display \(XML\)](#)¹⁶³ and [Table Display \(JSON\)](#)¹⁶⁷.

25.2.5 Copy as Image

The **Copy as Image** command is enabled only when the selected cell in the Table Display of [XML Grid View](#)¹⁶³ and [JSON Grid View](#)¹⁶⁷ contains an image. The command copies the Base64-encoded string of the selected image. If the string is pasted to a document where the Base64-encoded string can be rendered as an image (for example to another table cell in Table Display), then it will be rendered. Otherwise, it will be pasted as a string.

For more information, see the sections [Context Menu in Grid View](#)¹⁸⁹.

25.2.6 Copy XPath

The **Copy XPath** command is available in Text View and Grid View, and creates an XPath expression that locates the currently selected node/s in the document, and copies the XPath expression to the clipboard. This enables you to paste the XPath expression into a document (for example, in an XSLT document). All expressions start from the document root. For example, if an element called `LastName` of the third `Person` element of the second `Company` element is selected, the XPath expression that is copied would be: `/Companies/Company[2]/Person[3]/LastName`

Note: In Grid View the **Copy XPath** command can also be accessed via the context menu.

25.2.7 Copy XPointer/JSON-Pointer

The **Copy XPointer/JSON-Pointer** command is available in Grid View of XML and JSON documents and the Text View of XML documents. It copies to the clipboard an XPointer/JSON-Pointer expression that locates the selected node.

- *XML documents:* The command creates an `element()` scheme XPointer to the currently selected node/s of the XML document and copies the XPointer to the clipboard. For example, the XPointer `element(/1/3)` selects the third child of the document element (or root element).
- *JSON documents:* The command creates a JSON-Pointer to the currently selected node/s of the JSON document and copies the JSON-Pointer to the clipboard. For example, the JSON-Pointer `/Artists/1/Albums/2/Tracks/3/Title` selects a JSON node as follows: Lookup the first object of the top-level `Artists` array; in which, lookup the second object of the `Albums` array; in which, lookup the third object of the `Tracks` array; in which select the `Title` object.

Note the following points:

- XML attributes cannot be represented using the `element()` scheme. If an attribute is selected, the XPointer of the attribute's parent element is generated.
- If multiple XML elements are selected, then the XPointer of the first of these is generated.
- If a JSON value is selected, the JSON-Pointer of the value's key is generated.
- If multiple JSON nodes are selected, then the JSON-Pointer of the first of these is generated.

Note: The **Copy XPointer/JSON-Pointer** command can also be accessed via the context menu.

25.2.8 Insert

Mousing over or selecting the **Insert** command rolls out a submenu with three commands (described below):

- [Insert File Path](#)⁸⁰⁸
- [Insert XInclude](#)⁸⁰⁸
- [Insert Encoded External File](#)⁸¹¹

Insert File Path

The **File Path** command is enabled in the Text View and Grid View of documents of any file type. Using it, you can insert the path to a file at the cursor selection point. Clicking the command pops up a dialog (*screenshot below*) in which you select the required file.

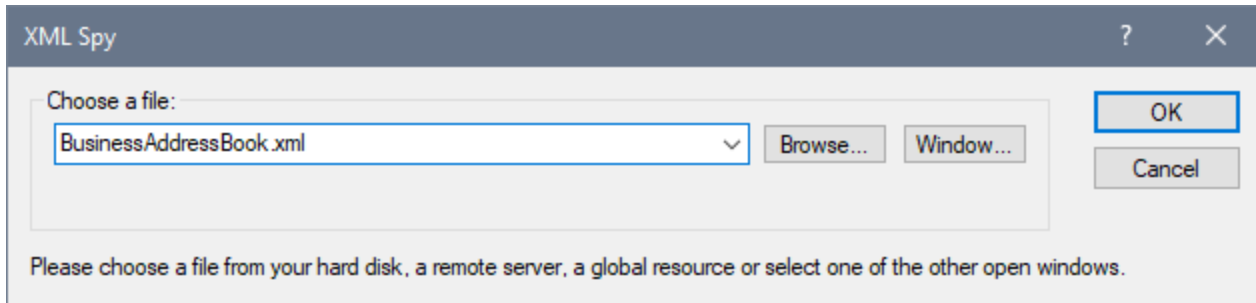

The required file can be selected in one of the following ways: (i) by browsing for the file, URL, or global resource (use the **Browse** ⁷⁸⁷ button); (ii) by selecting the window in which the file is open (the **Window** button). When done, click **OK**. The path to the selected file will be inserted in the active document at the cursor selection point.

Insert XInclude

The **XInclude** command is available in Text View and Grid View, and enables you to insert a new XInclude element at the cursor selection point in Text View, or before the selected item in both Text View and Grid View. If in Grid View the current selection is an attribute, the XInclude element is inserted after the attribute and before the first child element of the attribute's parent element. Selecting this command pops up the XInclude dialog (*screenshot below*).

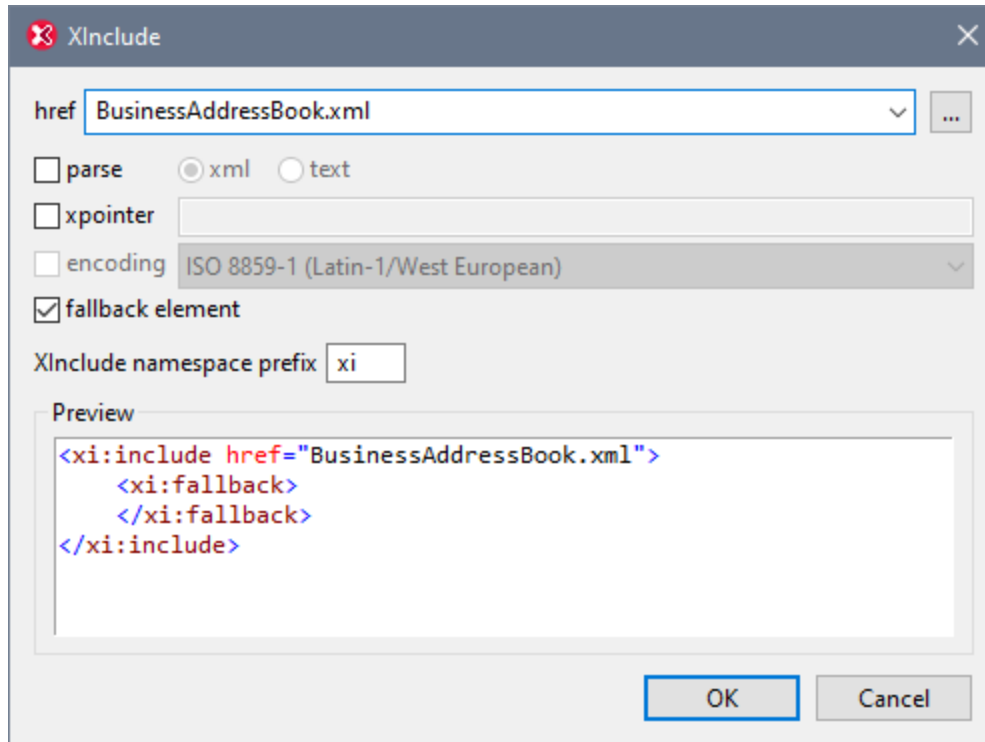

The XML file to be included is entered in the `href` text box (alternatively, you can browse for the file by clicking the **Browse (...)** button to the right of the text box). The filename will be entered in the XML document as the value of the `href` attribute. The `parse`, `xpointer`, and `encoding` attributes of the XInclude element (`xi:include`), and the `fallback` child element of `xi:include` can also be inserted via the dialog. Do this by first checking the appropriate check box and then selecting/entering the required values. In the case of the `fallback` element, checking its check box only inserts the empty element. The content of the `fallback` element must be added subsequently in one of the editing views.

The `parse` attribute determines whether the included document is to be parsed as XML or text. (XML is the default value and therefore need not be specified.) The `xpointer` attribute identifies a specific fragment of the document located with the `href` attribute; it is this fragment that will be included. The `encoding` attribute specifies the encoding of the included document so that XMLSpy can transcode this document (or the part of it to be included) into the encoding of the including document. The contents of the `fallback` child element replace the `xi:include` element if the document to be included cannot be located.

Here is an example of an XML document that uses XInclude to include two XML documents:

```
<?xml version="1.0" encoding="UTF-16"?>
<AddressBook xsi:schemaLocation="http://www.altova.com/sv/myaddresses AddressBook.xsd"
  xmlns="http://www.altova.com/stylevision/tutorials/myaddresses"
  xmlns:xsi="http://www.w3.org/2001/XMLSchema-instance"
  xmlns:xi="http://www.w3.org/2001/XInclude">
  <xi:include href="BusinessAddressBook.xml"/>
  <xi:include href="PersonalAddressBook.xml"/>
</AddressBook>
```

When this XML document is parsed, it will replace the two XInclude elements with the files specified in the

respective `href` attributes.

xml:base

When the XML validator of XMLSpy reads an XML document and encounters the `include` element in the `XInclude` namespace (hereafter `xi:include`), it replaces this element (`xi:include`) with the XML document named in the `href` attribute of the `xi:include` element. The document element (root element) of the included XML document (or the element identified by an XPointer) will be included with an attribute of `xml:base` in order to preserve the base URIs of the included element. If the resulting XML document (containing the included XML document/s or tree fragment/s) must be valid according to a schema, then the document element of the included document (or the top-level element of the tree fragment) must be created with a content model that allows an attribute of `xml:base`. If, according to the schema, the `xml:base` attribute is not allowed on this element, then the resulting document will be invalid. How to define an `xml:base` attribute in an element's content model using XMLSpy's Schema View is described in the [xml:Prefixed Attributes](#)²⁷² section of the Schema View section of the documentation.

XPointers

XMLSpy supports XPointers in `XInclude`. The relevant W3C recommendations are the [XPointer Framework](#) and [XPointer element\(\) Scheme](#) recommendations. The use of an XPointer in an `XInclude` element enables a specific part of the XML document to be included, instead of the entire XML document. XPointers are used within an `XInclude` element as follows:

```
<xi:include href="PersonalAddressBook.xml" xpointer="element(usa)"/>
<xi:include href="BusinessAddressBook.xml" xpointer="element(/1/1)"/>
<xi:include href="BobsAddressBook.xml" xpointer="element(usa/3/1)"/>
<xi:include href="PatsAddressBook.xml" xpointer="element(usa)element(/1/1)"/>
```

In the `element()` scheme of XPointer, an NCName or a child sequence directed by integers may be used.

- In the first `xi:include` element listed above, the `xpointer` attribute uses the element scheme with an NCName of `usa`. According to the XPointer Framework, this NCName identifies the element that has an ID of `usa`.
- In the second `xi:include` listed above, the `xpointer` attribute with a value of `element(/1/1)` identifies, in the first step, the first child element of the document root (which, if the document is well-formed, will be its document (or root) element). In the second step, the first child element of the element located in the previous step is located; in our example, this would be the first child element of the document element.
- The `xpointer` attribute of the third `xi:include` listed above uses a combination of NCName and child sequence. This XPointer locates the first child element of the third child element of the element having an ID of `usa`.
- If you are not sure whether your first XPointer will work, you can back it up with a second one as shown in the fourth `xi:include` listed above: `xpointer="element(usa)element(/1/1)"`. Here, if there is no element with an ID of `usa`, the back-up XPointer specifies that the first child element of the document element is to be selected. Additional backups are also allowed. Individual XPointers may not be separated, or they may be separated by whitespace: for example, `xpointer="element(usa) element(addresses/1) element(/1/1)"`.

Note: The namespace binding context is not used in the `element()` scheme because the `element()` scheme does not support qualified names.

Insert Encoded External File

The **Encoded External File** command is available in Text View and Grid View. It enables an external file to be included as encoded Base-16 or Base-64 text at any location in the XML document. This feature enables external files to be embedded in the XML document.

Clicking the **Insert | Encoded External File** command pops up the Insert Encoded External File dialog (screenshot below).

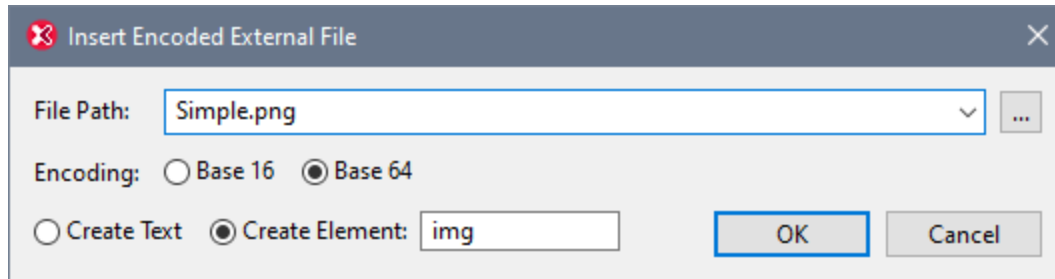

You can browse for or enter the name of the external file to be encoded and embedded. Either a Base-16 or Base-64 encoding must be specified. If you wish to enclose the encoded text in an element, then select *Create Element* and specify the name of the desired element (see screenshot above). Alternatively, select *Create Text* to insert the encoded text directly at the cursor location.

On clicking **OK**, the encoded text of the selected file is inserted at the cursor location—with an enclosing element if this has been specified.

```
<img ext="png" encoding="xs:base64Binary">
  iVBORw0KGgoAAAANSUgAAABAAAAQAQMAAAALPW0iAAAAAB1BMVEUAAAD/
  //+12Z/dAAAAM01EQVR4nGP4/5/h/1+G/58ZDrAz3D/McH8yw83NDDeNGe4U
  g9C9zwz3gVLMdA/A6P9/AFGGFyjOXZtQAAAAE1FTkSuQmCC
</img>
```

The listing above shows the encoded text of a PNG image file. An `img` element was created around the encoded text.

25.2.9 Save as Image

This command is enabled when a Base64-encoded image is selected in Text View or Grid View. It converts the selected Base64-encoded string to its image format. (Note that it is the Base64 string of the image that is displayed in Text View, but it is the image generated from this string that is displayed in Grid View.) On selecting the command, a Save As dialog appears. In it, select the location where you want to save the image and enter a name for the image file. The extension of the image file (`.png`, `.gif`, `.svg`, etc) will be auto-detected from the Base64 encoding and will appear in the Save dialog.

For more information, see the descriptions of Text View and Grid View in the sections about [XML](#)²⁸² and [JSON](#)⁸⁶⁴ documents.

25.2.10 Pretty-Print

Icon

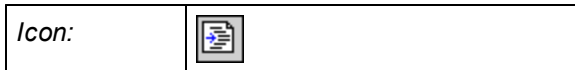

Description

The **Pretty-Print** command re-formats the text formatting of your XML or JSON document. The formatting properties are specified in the [Pretty Printing](#)¹⁰⁴⁸ settings of the Options dialog (**Tools | Options**). The indentation of text is specified in the [Text View Settings](#)⁹⁹⁵ dialog (**View | Text View Settings**).

Note the following points

- The XML document must be well-formed for this command to work.
- Pretty-printing adds spaces or tabs to the document when the document is saved.
- To remove all whitespace (new lines and indentation) created with the Pretty-Print command, use the [Strip Whitespaces](#)⁸¹² command.

25.2.11 Strip Whitespaces

Icon

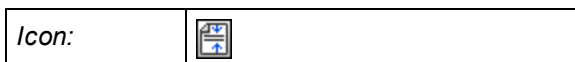

Description

The **Strip Whitespaces** command strips all whitespace from the document. This can help reduce file size. This command can be useful if you wish to remove whitespace generated by the [Pretty-Print](#)⁸¹² command.



25.2.12 Select All

The **Select All** command (**Ctrl+A**) selects the contents of the entire document.

25.2.13 Find, Find Next

Icons and shortcuts

| Command | Icon | Shortcut |
|---------|------|----------|
|---------|------|----------|

| | | |
|------------------|---|---------------|
| Find |  | Ctrl+F |
| Find Next |  | F3 |

Find

The **Find** command displays the Find/Replace dialog (see *screenshot below*), in which you can specify the string you want to find and other options for the search. To find text, enter the text in the Find field or use the combo box to select from one of the last 10 search criteria, and then specify the options for the search.

The **Find** command can also be used to find file and folder names when a project is selected in the [Project window](#)¹¹⁰.

Find Next

The **Find Next** command repeats the last Find command. It searches for the next occurrence of the input text.

The **Find Next** command can also be used to find file and folder names when a project is selected in the [Project window](#)¹¹⁰.

Find/Replace dialog

The Find/Replace dialog described below appears in [Text View](#)¹³⁰ and [Grid View](#)¹⁴⁶. The Find options can be specified via buttons located below the search term field (see *screenshot below*). When an option is toggled on, its button color changes to blue (see *the first (casing) option in the screenshot below*).

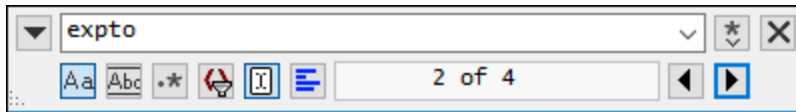

You can select from the following options:

- **Match case:** Case-sensitive search when toggled on (`Address` is not the same as `address`).
- **Match whole word:** Only the exact words in the text will be matched. For example, for the input string `fit`, with **Match whole word** toggled on, only the word `fit` will match the search string; the `fit` in `fitness`, for example, will not be matched.
- **Regular expression:** If toggled on, the search term will be read as a regular expression. See *Regular expressions* below for a description of how regular expressions are used.
- **Filter results:** Select one or more document components where the search is to be carried out.
- **Find anchor:** Found items are indexed in document order and the index of the currently selected item is given in the Find dialog. For example, from the information in the screenshot above, we can tell that the second found item from four is currently selected. Clicking **Find Next** (highlighted at bottom right in the screenshot) takes you to the next found item in index order. However, if the **Find Anchor** option is selected, **Find Next** takes you to the next found item *relative to the current cursor position*. So, if the currently selected item is the first (say, 1 of 4) and you were to place the cursor after item 3, then **Find Next** would take you to item 4—and not to item 2 (as would have happened if **Find Anchor** was toggled off).
- **Find in selection:** When toggled on, locks the current text selection and restricts the search to the selection. Otherwise, the entire document is searched. Before selecting a new range of text, unlock the current selection by toggling off the **Find in Selection** option.

Regular expressions

You can use regular expressions (regex) to find a text string. To do this, first, switch the *Regular expression* option on (see *Find options* above). This specifies that the text in the search term field is to be evaluated as a regular expression. Next, enter the regular expression in the search term field. For help with building a regular expression, click the **Regular Expression Builder** button, which is located to the right of the search term field (see *screenshot below*). Click an item in the Builder to enter the corresponding regex metacharacter/s in the search term field. The screenshot below shows a simple regular expression to find email addresses. For a brief description of metacharacters, see the section *Regular expression metacharacters* below.

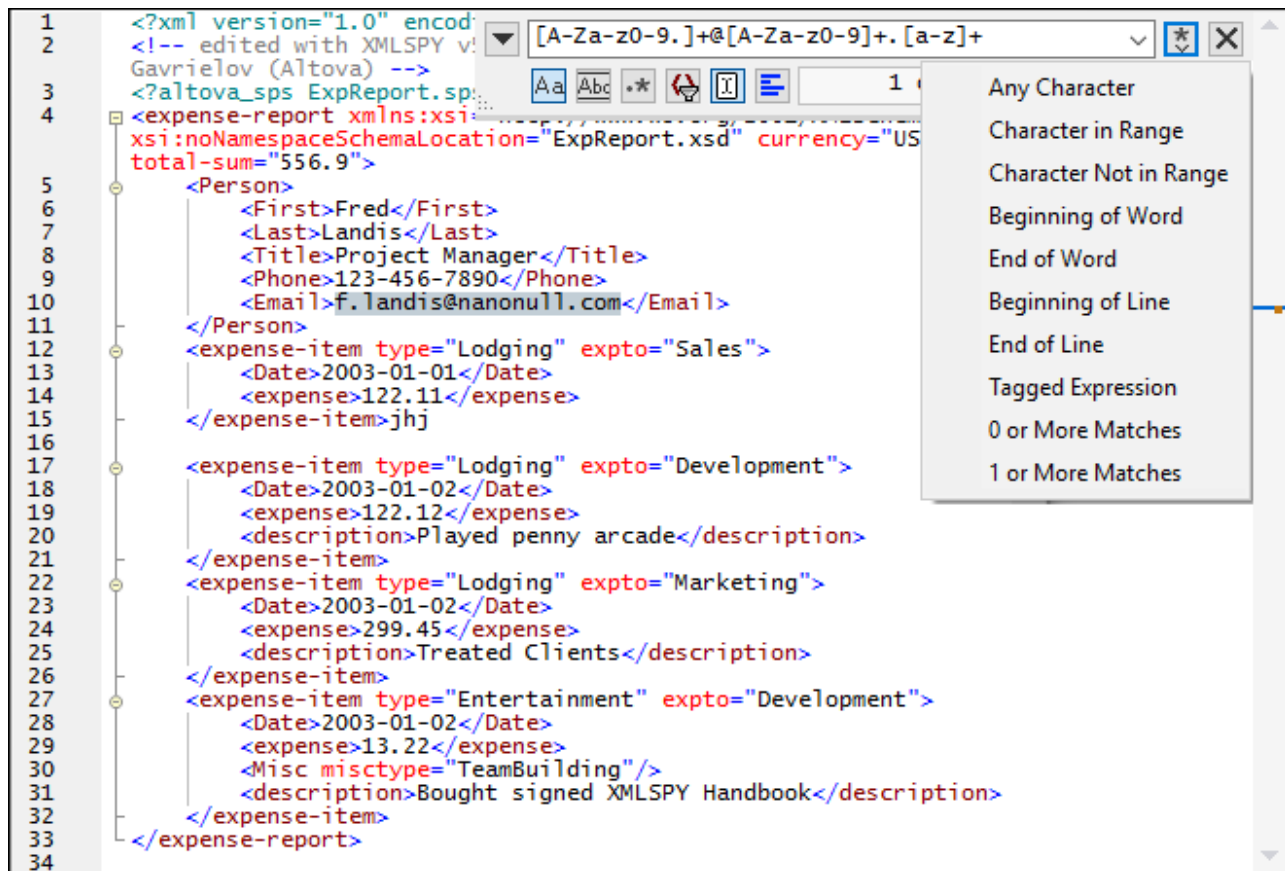

Regular expression metacharacters

Given below is a list of regular expression metacharacters.

| | |
|-------|--|
| . | Matches any character. This is a placeholder for a single character. |
| (| Marks the start of a tagged expression. |
|) | Marks the end of a tagged expression. |
| (abc) | The (and) metacharacters mark the start and end of a tagged expression. Tagged expressions may be useful when you need to tag ("remember") a matched region for the purpose of referring to it later (back-reference). Up to nine expressions can be tagged (and then back-referenced later, either in the Find or Replace field). |

| | |
|---------------------|---|
| | For example, <code>(the) \1</code> matches the string <code>the the</code> . This expression can be literally explained as follows: match the string "the" (and remember it as a tagged region), followed by a space character, followed by a back-reference to the tagged region matched previously. |
| <code>\n</code> | Where <code>n</code> is a variable that can take integer values from 1 through 9. The expression refers to the first through ninth tagged region when replacing. For example, if the find string is <code>Fred([1-9])XXX</code> and the replace string is <code>Sam\1YYY</code> , this means that in the find string there is one tagged expression that is (implicitly) indexed with the number 1; in the replace string, the tagged expression is referenced with <code>\1</code> . If the find-replace command is applied to <code>Fred2XXX</code> , it would generate <code>Sam2YYY</code> . |
| <code>\<</code> | Matches the start of a word. |
| <code>\></code> | Matches the end of a word. |
| <code>\x</code> | Allows you to use a character <code>x</code> , which would otherwise have a special meaning. For example, <code>\[</code> would be interpreted as <code>[</code> and not as the start of a character set. |
| <code>[...]</code> | Indicates a <i>set of characters</i> . For example, <code>[abc]</code> means any of the characters <code>a</code> , <code>b</code> or <code>c</code> . You can also use ranges: for example <code>[a-z]</code> for any lower case character. |
| <code>[^...]</code> | The complement of the characters in the set. For example, <code>[^A-Za-z]</code> means any character except an alphabetic character. |
| <code>^</code> | Matches the start of a line (unless used inside a set, <i>see above</i>). |
| <code>\$</code> | Matches the end of a line. Example: <code>A+\$</code> to find one or more <code>A</code> 's at end of line. |
| <code>*</code> | Matches 0 or more times. For example, <code>Sa*m</code> matches <code>Sm</code> , <code>Sam</code> , <code>Saam</code> , <code>Saaam</code> and so on. |
| <code>+</code> | Matches 1 or more times. For example, <code>Sa+m</code> matches <code>Sam</code> , <code>Saam</code> , <code>Saaam</code> and so on. |

Representation of special characters

Note the following expressions.

| | |
|-----------------|--|
| <code>\r</code> | Carriage Return (CR). You can use either CR (<code>\r</code>) or LF (<code>\n</code>) to find or create a new line |
| <code>\n</code> | Line Feed (LF). You can use either CR (<code>\r</code>) or LF (<code>\n</code>) to find or create a new line |
| <code>\t</code> | Tab character |
| <code>\\</code> | Use this to escape characters that appear in regex expression, for example: <code>\\n</code> |

Regular expression examples

This example illustrates how to find and replace text using regular expressions. In many cases, finding and replacing text is straightforward and does not require regular expressions at all. However, there may be instances where you need to manipulate text in a way that cannot be done with a standard find and replace operation. Consider, for example, that you have an XML file of several thousand lines where you need to rename certain elements in one operation, without affecting the content enclosed within them. Another example: you need to change the order of multiple attributes of an element. This is where regular expressions can help you, by eliminating a lot of work which would otherwise need to be done manually.

Example 1: Renaming elements

The sample XML code listing below contains a list of books. Let's suppose your goal is to replace the <Category> element of each book to <Genre>. One of the ways to achieve this goal is by using regular expressions.

```
<?xml version="1.0" encoding="UTF-8"?>
<books xmlns:xsi="http://www.w3.org/2001/XMLSchema-instance"
xsi:noNamespaceSchemaLocation="books.xsd">
  <book id="1">
    <author>Mark Twain</author>
    <title>The Adventures of Tom Sawyer</title>
    <category>Fiction</category>
    <year>1876</year>
  </book>
  <book id="2">
    <author>Franz Kafka</author>
    <title>The Metamorphosis</title>
    <category>Fiction</category>
    <year>1912</year>
  </book>
  <book id="3">
    <author>Herman Melville</author>
    <title>Moby Dick</title>
    <category>Fiction</category>
    <year>1851</year>
  </book>
</books>
```

To solve the requirement, follow the steps below:

1. Press **Ctrl+H** to open the Find and Replace dialog box.
2. Click **Use regular expressions** .
3. In the Find field, enter the following text: `<category>(.*?)</category>`. This regular expression matches all `category` elements, and they become highlighted.

```

1  <?xml version="1.0" encoding="UTF-8"?>
2  <books xmlns:xsi="http://www.w3.org/2001/XMLSchema"
   books.xsd">
3  <book id="1">
4  <author>Mark Twain</author>
5  <title>The Adventures of Tom Sawyer</title>
6  <category>Fiction</category>
7  <year>1876</year>
8  </book>
9  <book id="2">
10 <author>Franz Kafka</author>
11 <title>The Metamorphosis</title>
12 <category>Fiction</category>
13 <year>1912</year>
14 </book>
15 <book id="3">
16 <author>Herman Melville</author>
17 <title>Moby Dick</title>
18 <category>Fiction</category>
19 <year>1851</year>
20 </book>
21 </books>

```

To match the inner text of each element (which is not known in advance), we used the tagged expression `(.+)`. The tagged expression `(.+)` means "match one or more occurrences of any character, that is `.`, and remember this match". As shown in the next step, we will need the reference to the tagged expression later.

- In the Replace field, enter the following text: `<genre>\1</genre>`. This regular expression defines the replacement text. Notice it uses a back-reference `\1` to the previously tagged expression from the Find field. In other words, `\1` in this context means "the inner text of the currently matched `<category>` element".
- Click **Replace All** and observe the results. All `category` elements have now been renamed to `genre`, which was the intended goal.

Example 2: Changing the order of attributes

The sample XML code listing below contains a list of products. Each product element has two attributes: `id` and a `size`. Let's suppose your goal is to change the order of `id` and `size` attributes in each `product` element (in other words, the `size` attribute should come before `id`). One of the ways to solve this requirement is by using regular expressions.

```

<?xml version="1.0" encoding="UTF-8"?>
<products xmlns:xsi="http://www.w3.org/2001/XMLSchema-instance"
xsi:noNamespaceSchemaLocation="products.xsd">
  <product id="1" size="10"/>
  <product id="2" size="20"/>
  <product id="3" size="30"/>
  <product id="4" size="40"/>
  <product id="5" size="50"/>
  <product id="6" size="60"/>
</products>

```

To solve the requirement, follow the steps below:

- Press **Ctrl+H** to open the Find and Replace dialog box.

2. Click **Use regular expressions** .
3. In the Find field, enter the following: `<product id="(.)" size="(.)"/>`. This regular expression matches a product element in the XML document. Notice that, in order to match the value of each attribute (which is not known in advance), a tagged expression `(.)` is used twice. The tagged expression `(.)` matches the value of each attribute (assumed to be one or more occurrences of any character, that is `.+`).
4. In the Replace field, enter the following: `<product size="\2" id="\1"/>`. This regular expression contains the replacement text for each matched product element. Notice that it uses two references `\1` and `\2`. These correspond to the tagged expressions from the Find field. In other words, `\1` means "the value of attribute `id`" and `\2` means "the value of attribute `size`".

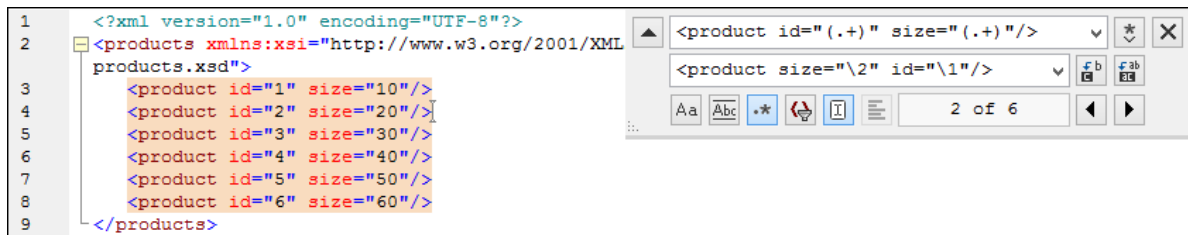

6. Click **Replace All**  and observe the results. All `product` elements have now been updated so that attribute `size` comes before attribute `id`.

25.2.14 Replace

Icons and shortcuts

| Command | Icon | Shortcut |
|----------------|---|---------------|
| Replace |  | Ctrl+H |

Description

The **Replace** command in [Text View](#)¹³⁰ and [Grid View](#)¹⁴⁶ causes the Find/Replace dialog (*screenshot below*) to appear. In this dialog, you can specify that one string be found and replaced with another string. For a description of the options for the Find string, see the [Find](#)⁸¹² command. You can replace each item individually, or you can use the **Replace All** button to perform a global find-and-replace operation.

To replace a text string, do the following:

1. Press **Ctrl+H** (or select the menu command **Edit | Replace**) to open the Find/Replace dialog (*screenshot below*). (Alternatively, you can switch to Replace mode of the Find/Replace dialog by clicking the down-arrow button at the top left of the dialog.)

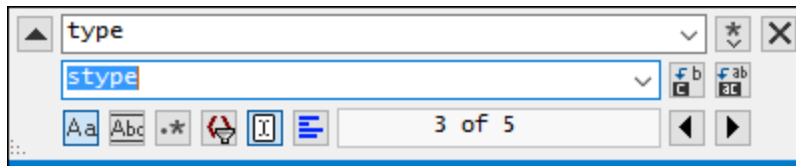

2. Enter the string to be replaced in the Find field, and enter the new string in the Replace field. The number of text matches to replace and the index of the currently selected match is displayed below the Replace field. Also, the locations of matches are indicated in the scroll bar by beige markers (see *Searching for text in a document above for more information*). For example, the screenshot above shows that there are five text matches for the string `type`, and that the third of these matches is currently selected.
3. The **Replace Next** and **Replace All** buttons are located to the right of the Replace field. If you click **Replace Next**, one of the following happens: (i) If the cursor is located adjacent to a match or inside a match, then the match is replaced; (ii) if the cursor is located outside a match, it jumps to the next match; click **Replace Next** to replace this match. Click **Replace All** to replace all matches.

Note the following points:

- To replace text within a selection—rather than the entire document—do the following: (i) Mark the selection; (ii) Toggle on the *Find in Selection* option to lock the selection; (iii) Enter the Find and Replace text strings; (iii) Click **Replace Next** or **Replace All** as required. To replace text within another selection, unlock the current selection by toggling off the *Find in Selection* option, then make the new selection and toggle on the *Find in Selection* option to lock the new selection.
- To undo a replace action, press **Ctrl+Z** or select **Edit | Undo**.

Note: When using the **Replace All** command, each replacement is recorded as a single operation, so **Replace All** can be undone step-by-step.

25.2.15 Find in Files

The **Find in Files** command is a powerful way to find and replace text quickly among a large number of files. Clicking the command pops up the Find in Files dialog (*screenshot below*). The **Find in Files** command is different from the **Find** command in that it searches all the specified locations for the Find string at once and executes replace actions immediately. A report is then displayed in the [Find in Files window](#)¹¹⁷. In the case of the **Find** command, however, the user enters the search string and goes through the (single) active document one found item at a time.

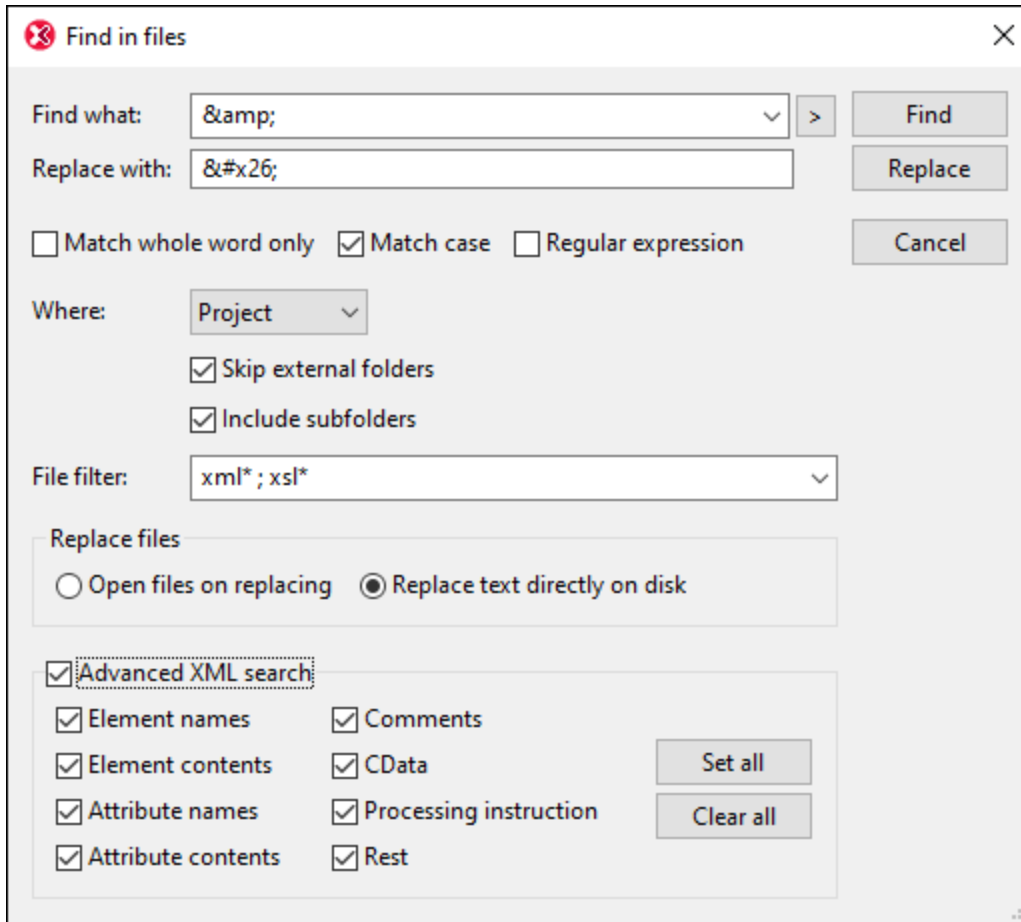

Find criteria

There are two broad find criteria: (i) what to find, and (ii) where to look? For a description of how to set the text that is to be searched (what to find), see the description of the [Find](#)⁸¹² command. If the text entered in the Find What text box is a regular expression, then the Regular Expression check box must be checked. An entry helper for regular expressions can be accessed by clicking the **Unfold** button to the right of the *Find What* input box (the button marked >) button. The use of regular expressions for searching is explained in the section about the [Find](#)⁸¹⁴ command.

To specify what node types and parts of an XML document should be searched, check the Advanced XML Search check box and then select the required node types.

You can specify where to search: (i) in a Project; (ii) in the files currently open in XMLSpy; (iii) in a project; or (iv) in a folder. When a project folder is selected, external folders added to the project can be skipped. The files to be searched can be filtered by file extension and a star (xml* or xsl*, for example). The separator between two file extensions can be a comma or a semi-colon (xml*;xsl*, for example). The star character can also be used as a wildcard.

The instances of the Find string at all the search locations are listed in the [Find in Files window](#)¹¹⁷. Clicking on one of the listed items opens that file in Text View and highlights the item.





Replace

The most important thing to note is that clicking the **Replace** button replaces all the instances of the Find string with the Replace string. If *Open Files On Replacing* was checked in the Find in Files dialog, then the file will be opened in Text View; otherwise the replacement is done silently. All the replaced strings are listed in the [Find in Files window](#)¹¹⁷. Clicking on one of the listed items opens that file in Text View and highlights the item.

Note: Regular expressions are not supported in the Replace field.

25.2.16 Bookmark Commands

Icons and shortcuts

| Command | Icon | Shortcut |
|------------------------|---|---------------|
| Insert/Remove Bookmark |  | Ctrl+F2 |
| Remove All Bookmarks |  | Ctrl+Shift+F2 |
| Goto Next Bookmark |  | F2 |
| Goto Previous Bookmark |  | Shift+F2 |

Insert/Remove Bookmark

The **Insert/Remove Bookmark** command inserts a bookmark at the current cursor position, or removes the bookmark if the cursor is in a line that has been bookmarked previously. This command is only available in Text View.

Bookmarked lines are displayed in one of the following ways:

- If the bookmarks margin has been enabled, then a solid blue ellipse appears to the left of the text in the bookmark margin.
- If the bookmarks margin has not been enabled, then the entire line containing the cursor is highlighted.

The **F2** key cycles through all the bookmarks in the document.

Remove All Bookmarks

The **Remove All Bookmarks** command removes all the currently defined bookmarks. This command is only available in Text View. Note that the **Undo** command does not undo the effects of **Remove All Bookmarks**.

Goto Next Bookmark

The **Goto Next Bookmark** command places the text cursor at the beginning of the next bookmarked line. This command is only available in Text View.

Goto Previous Bookmark

The **Goto Previous Bookmark** command places the text cursor at the beginning of the previous bookmarked line. This command is only available in Text View.

25.2.17 Comment In/Out

The **Comment In/Out** command is available in Text View and is used to comment and uncomment XML text fragments. Text in an XML document can be commented out using the XML start-comment and end-comment delimiters, respectively `<!--` and `-->`. In XMLSpy, these comment delimiters can be inserted around a text selection by using the **Comment In/Out** menu command.

To comment out a block of text, select the text to be commented out and then select the command **Comment In/Out**, either from the **Edit** menu or the context menu you get on right-clicking the selected text. The commented text will be grayed out (see *screenshot below*).

```
<Department>
  <Name>Administration</Name>
  <Person>
  <Person>
  <Person>
  <!--<Person>
    <First
    <Last></Last>
    <PhoneExt></PhoneExt>
    <EMail></EMail>
    <LeaveTotal></LeaveTotal>
    <LeaveUsed></LeaveUsed>
    <LeaveLeft></LeaveLeft>
  </Person>-->
</Department>
```

To uncomment a commented block of text, place the cursor in the commented block and select the command **Comment In/Out**, either from the **Edit** menu or the context menu you get on right-clicking within the commented-out text. The comment delimiters will be removed and the text will no longer be grayed out.

25.3 Project Menu

XMLSpy uses the familiar tree view to manage multiple files or URLs in XML projects. [Files](#)⁸⁴⁰ and [URLs](#)⁸⁴¹ can be grouped into [folders](#)⁸⁴² by common extension or any arbitrary criteria, allowing for easy structuring and batch manipulation.

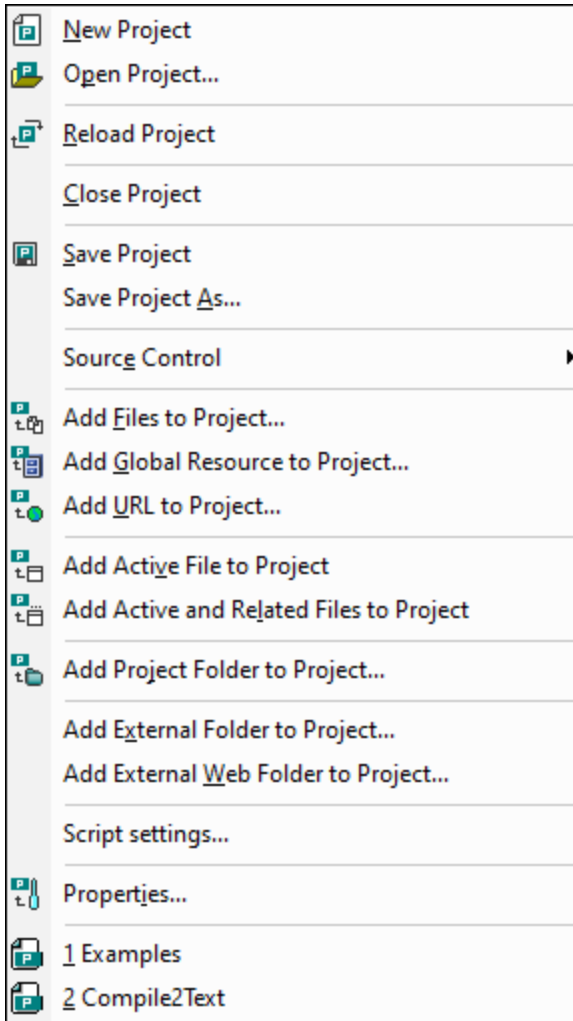

Please note: Most project-related commands are also available in the context menu, which appears when you right-click any item in the project window.

Absolute and relative paths

Each project is saved as a project file, and has the `.spp` extension. These files are actually XML documents that you can edit like any regular XML File. In the project file, absolute paths are used for files/folders on the same level or higher, and relative paths for files/folders in the current folder or in sub-folders. For example, if your directory structure looks like this:

```
| -Folder1
|   |
```

```
| |-Folder2
|   |
|   |-Folder3
|       |
|       |-Folder4
```

If your `.spp` file is located in `Folder3`, then references to files in `Folder1` and `Folder2` will look something like this:

```
c:\Folder1\NameOfFile.ext
c:\Folder1\Folder2\NameOfFile.ext
```

References to files in `Folder3` and `Folder4` will look something like this:

```
.\NameOfFile.ext
.\Folder4\NameOfFile.ext
```

If you wish to ensure that all paths will be relative, save the `.spp` files in the root directory of your working disk.

Drag-and-drop

In the Project window, a folder can be dragged to another folder or to another location within the same folder. A file can be dragged to another folder, but cannot be moved within the same folder (within which files are arranged alphabetically). Additionally, files and folders can be dragged from Windows File Explorer to the Project window.

Find in project

You can search for project files and folders using their names or a part of their name. If the search is successful, files or folders that are located are highlighted one by one.

To start a search, select the project folder in the Project sidebar that you wish to search, then select the command **Edit | Find** (or the shortcut **Ctrl+F**). In the Find dialog that pops up (*screenshot below*) enter the text string you wish to search for and select or deselect the search options (*explained below*) according to your requirements.

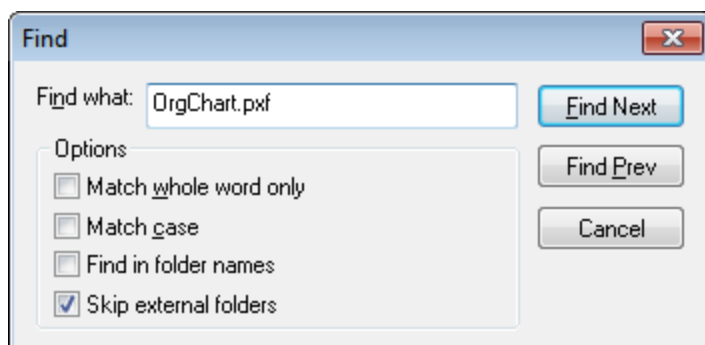

The following search options are available:

- Whole-word matching is more restricted since the entire string must match an entire word in the file or folder name. In file names, the parts before and after the dot (without the dot) are each treated as a word.

- It can be specified that casing in the search string must exactly match the text string in the file or folder name.
- Folder names can be included in the search. Otherwise, only file names are searched.
- [External folders](#)⁸⁴² can be included or excluded from the search. External folders are actual folders on the system or network, as opposed to project folders, which are created within the project and not on the system.

If the search is successful, the first matching item is highlighted in the Project sidebar. You can then browse through all the returned matching items by clicking the **Find Next** and **Find Prev** buttons in the Find dialog.

Refreshing projects

If a change is made to an external folder, this change will not be reflected in the Project Window till the project is refreshed.

Global resources in the context menu

When you right-click a folder in the Project window, in the context menu that appears, you can select the **Add Global Resource** menu item to add a [global resource](#)⁶⁹⁶. The menu command itself pops up the Choose Global Resource dialog, which lists all the file-type and folder-type global resources in the currently active Global Resources XML File. Select the required global resource, and it will be added to the selected project folder.

Projects and source control providers

If you intend to add an XMLSpy project to a source control repository, please ensure that the project file's position in the hierarchical file system structure is one which enables you to add files only from below it (taking the root directory to be the top of the directory tree).

In other words, the directory where the **project file** is located, essentially represents the **root directory** of the project within the source control repository. Files added from above it (the project root directory) will be added to the XMLSpy project, but their location in the repository may be an unexpected one—if they are allowed to be placed there at all.

For example, given the directory structure shown above, if a project file is saved in `Folder3` and placed under source control:

- Files added to Folder1 may not be placed under source control,
- Files added to Folder2 are added to the root directory of the repository, instead of to the project folder, but are still under source control,
- Files located in Folder3 and Folder4 work as expected, and are placed under source control.

25.3.1 New Project



The **New Project** command creates a **new** project in XMLSpy. If you are currently working with another project, a prompt appears asking if you want to close all documents belonging to the current project. The project's name is assigned when you save the project as a `.spp` file.

25.3.2 Open Project



The **Open Project** command opens an existing project in XMLSpy. If you are currently working with another project, the previous project is closed first.

25.3.3 Reload Project



The **Reload Project** command reloads the current project from disk. If you are working in a multi-user environment, it can sometimes become necessary to reload the project from disk, because other users might have made changes to the project.

Please note: Project files (`.spp` files) are actually XML documents that you can edit like any regular XML File.

25.3.4 Close Project

The **Close Project** command **closes** the active project. If the project has been modified, you will be asked whether you want to save the project first. When a project is modified in any way, an asterisk is added to the project name in the Project Window.

25.3.5 Save Project, Save Project As



The **Save Project** command **saves** the current project. You can also save a project by making the project window active and clicking the  icon.

The **Save Project As** command **saves** the current project with a new name that you can enter when prompted for one.

25.3.6 Source Control

Your Altova application supports Microsoft SourceSafe and other compatible repositories. A list of supported systems is given in the section, [Supported Source Control Systems](#)⁷⁴⁵. This section describes the commands in the **Project | Source Control** submenu, which are used to work with the source control system from within your Altova application.

Overview of the Source Control feature

The mechanism for placing files in an application project under source control is as follows:

1. In XMLSpy, an application project folder containing the files to be placed under source control is created. Typically, the application project folder will correspond to a local folder in which the project files are located. The path to the local folder is referred to as the local path.
2. In the source control system's database (also referred to as source control or repository), a folder is created that will contain the files to be placed under source control.
3. Application project files are added to source control using the command [Project | Source Control | Add to Source Control](#)⁸³³.
4. Source control actions, such as checking in to, checking out from, and removing files from source control, can be carried out by using the commands in the [Project | Source Control](#)⁸²⁷ submenu⁸²⁷. The commands in this submenu are listed in the sub-sections of this section.

Note: If you wish to change the current source control provider, this can be done in any of two ways: (i) via the Source Control options ([Tools | Options | Source Control](#)¹⁰⁷⁴), or (ii) in the Change Source Control dialog ([Project | Source Control | Change Source Control](#)⁸³⁹).

Note: Note that a source control project is not the same as an application project. Source control projects are directory-dependent, while XMLSpy projects are logical constructions without direct directory dependence.

For additional information, see the section, [Source Control](#)⁷⁴².

25.3.6.1 Open from Source Control

The **Open from Source Control** command creates a new application project from a project under source control.

Create the new project as follows:

1. Depending on the source control system used, it might be necessary, before you create a new project from source control, to make sure that no file from the project is checked out.
2. No project need be open in the application, but can be.
3. Select the command **Project | Source Control | Open from Source Control**.
4. The source control system that is currently set will pop up its verification and connection dialogs. Make the connection to the repository you want, that is, to the bound folder in the repository that corresponds to the local folder.
5. In the dialog that pops up (*screenshot below*), browse for the local folder to which the contents of the bound folder in the repository (that you have just connected to) must be copied. In the screenshot

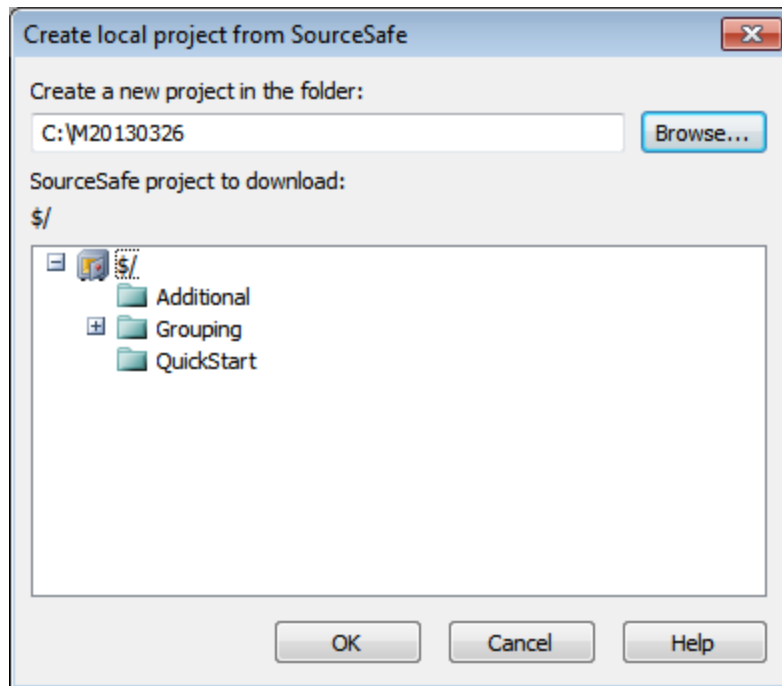

below the bound folder is called `MyProject` and is represented by the `$` sign; the local folder is `C:\M20130326`.



6. Click **OK**. The contents of the bound folder (`MyProject`) will be copied to the local folder `C:\M20130326`., and a dialog pops up asking you to select the project file (`.spp` file) that is to be created as the new project.
7. Select the `.spp` file that will have been copied to the local folder. In our example, this will be `MyProject.spp` located in the `C:\M20130326` folder. A new project named `MyProject` will be created in the application and will be displayed in the Project window. The project's files will be in the folder `C:\M20130326`.



Source control symbols

Files and the project folder display certain symbols, the meanings of which are given below.

| | |
|---|---|
|  | Checked in. Available for check-out. |
|  | Checked out by another user. Not available for check-out. |
|  | Checked out locally. Can be edited and checked-in. |

25.3.6.2 Enable Source Control

The **Enable Source Control** command allows you to enable or disable source control for an application project. Selecting this option on any file or folder, enables/disables source control for the whole project. After source control is enabled, the check in/out status of the various files are retrieved and displayed in the Project window.

| | |
|---|---|
|  | Checked in. Available for check-out. |
|  | Checked out by another user. Not available for check-out. |
|  | Checked out locally. Can be edited and checked-in. |

25.3.6.3 Get Latest Version

The **Get Latest Version** command (in the **Project | Source Control** menu) retrieves and places the latest source control version of the selected file(s) in the working directory. The files are retrieved as read-only and are not checked out. This command works like the [Get command](#)⁸²⁹, but does not display the Get dialog. If the selected files are currently checked out, then the action taken will depend on how your source control system handles such a situation. Typically, the source control system will ask whether you wish to replace, merge with, or leave the checked-out file as it is.

Note: This command is recursive when performed on a folder, that is, it affects all files below the current one in the folder hierarchy.

25.3.6.4 Get, Get Folders

The **Get** command (in the **Project | Source Control** menu) retrieves files from the repository as read-only files. (To be able to edit a file, you must check it out.) The Get dialog lists the files in the object (project or folder) on which the **Get** command was executed (see *screenshot below*). You can select the files to retrieve by checking them.

Note: The **Get Folders** command allows you to select individual sub-folders in the repository if this is allowed by your source control system, .

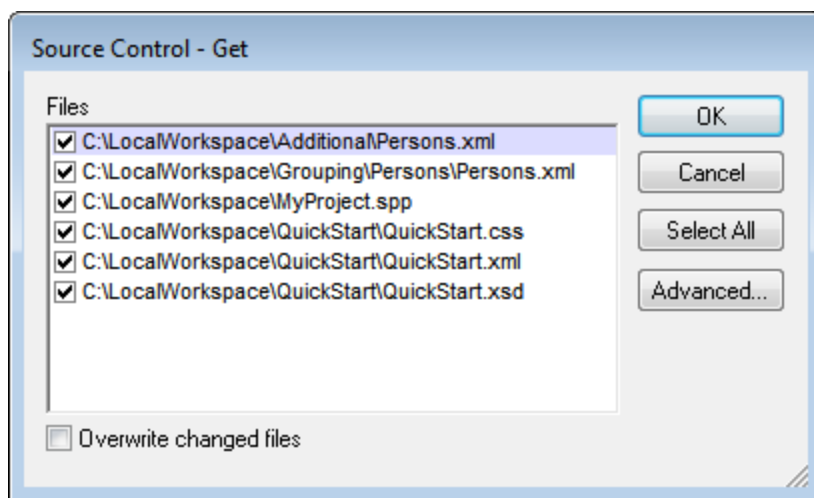

You can choose to overwrite changed checked-out files by checking this option at the bottom of the Get dialog. On clicking **OK**, the files will be overwritten. If any of the overwritten files is currently open, a dialog pops up

(*screenshot below*) asking whether you wish to reload the file/s (**Reload** button), close the file/s (**Close**), or retain the current view of the file (**Cancel**).

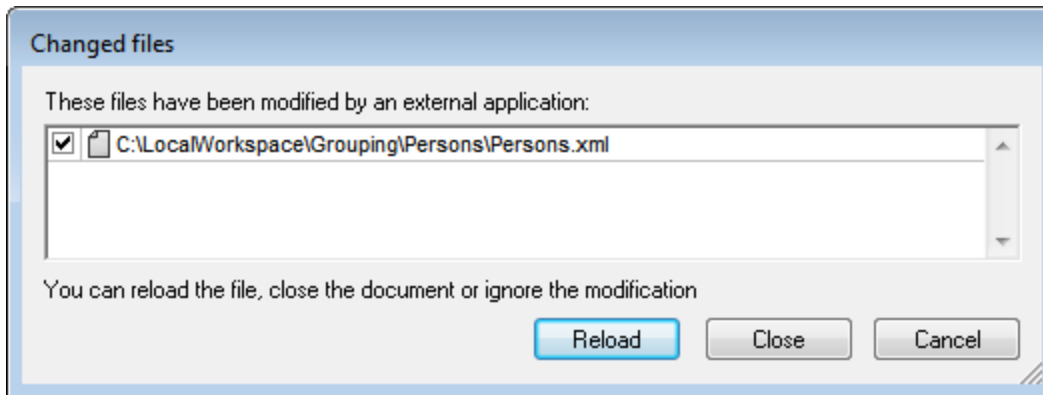

Advanced Get Options

The Advanced Get Options dialog (*screenshot below*) is accessed via the **Advanced** button in the Get dialog (see *first screenshot in this section*).

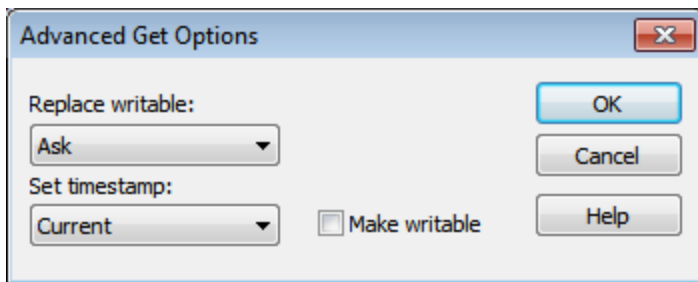



Here you can set options for (i) replacing writable files that are checked out, (ii) the timestamp, and (iii) whether the read-only property of the retrieved file should be changed so that it will be writable.

25.3.6.5 Check Out, Check In

After a project file has been placed under source control, it can be checked out or checked in by selecting the file (in the Project window) and clicking the respective command in the **Project | Source Control** menu: **Check Out** and **Check In**.

When a file is checked out, a copy from the repository is placed in the local folder. A file that is checked out can be edited. If a file that is under source control is not checked out, it cannot be edited. After a file has been edited, the changes can be saved to the repository by checking in the file. Even if the file is not saved, checking it in will save the changes to the repository. Whether a file is checked out or not is indicated with a tick or lock symbol in its icon.

Files and the project folder display certain symbols, the meanings of which are given below.

| | |
|---|---|
|  | Checked in. Available for check-out. |
|  | Checked out by another user. Not available for check-out. |
|  | Checked out locally. Can be edited and checked-in. |

Selecting the project or a folder within the project, selects all files in the selected object. To select multiple objects (files and folders), press the Ctrl key while clicking the objects. The screenshot below shows a project that has been checked out. The file `QuickStart.css` has subsequently been checked in.

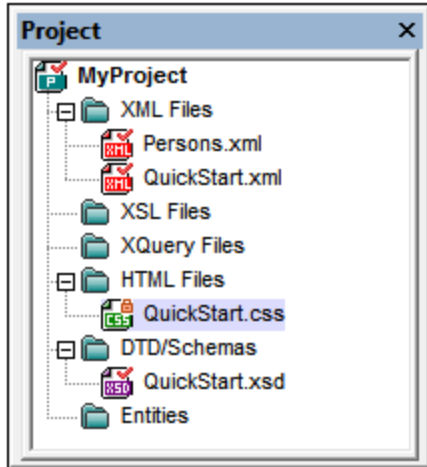

Saving and rejecting editing changes

Note that, when checking in a file, you can choose to leave the file checked out. What this does is save editing changes to the repository while continuing to keep the file checked out, which is useful if you wish to periodically save editing changes to the repository and then continue editing.

If you have checked out a file and made editing changes, and then wish to reject these changes, you can revert to the document version saved in the repository by selecting the command **Project | Source Control | Undo Check Out**.

Checking out

The Check Out dialog (*screenshot below*) allows you: (i) to select the files to check out, and (ii) to select whether the repository version or the local version should be checked out.

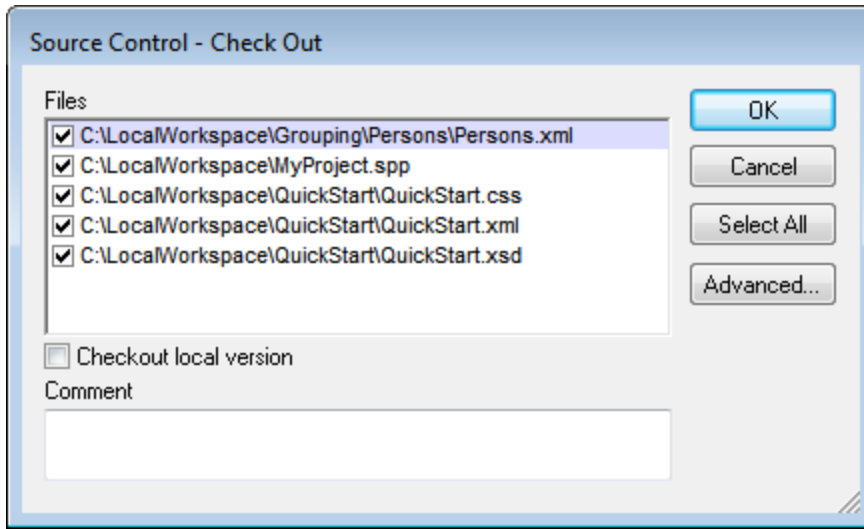

Checking in

The Check In dialog (*screenshot below*) allows you: (i) to select the files to check in, and (ii) if you wish, to keep the file checked out.

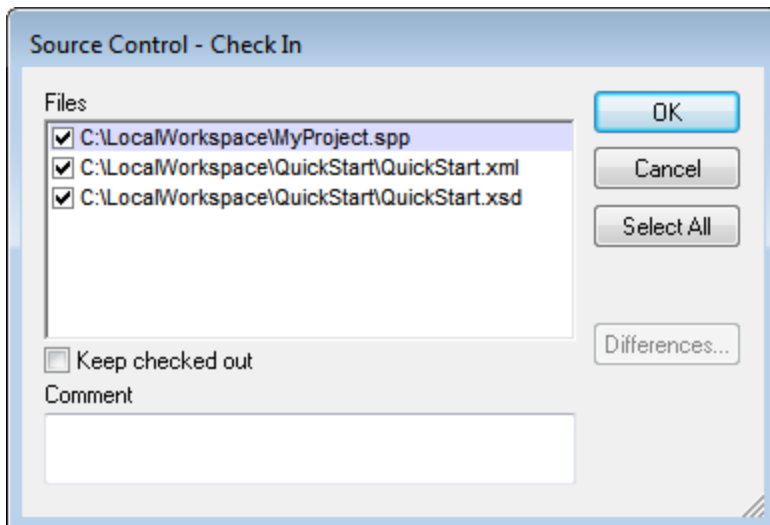



Note: In both dialogs (Check Out and Check In), multiple files appear if the selected object (project or project folder/s) contain multiple files.

25.3.6.6 Undo Check Out

If you have checked out a file and made editing changes, and then wish to reject these changes, you can revert to the document version saved in the repository by selecting the command **Project | Source Control | Undo Check Out**.

Files and the project folder display certain symbols, the meanings of which are given below.

| | |
|---|---|
|  | Checked in. Available for check-out. |
|  | Checked out by another user. Not available for check-out. |
|  | Checked out locally. Can be edited and checked-in. |

25.3.6.7 Add to Source Control

After a project has been added to source control, you can add files either singly or in groups to source control. Select the file in the Project window and then click the command **Project | Source Control | Add to Source Control**. To select multiple files, keep the **Ctrl** key pressed while clicking on the files you wish to add. Running the command on a (green) project folder (see *screenshot below*) adds all files in the folder and its sub-folders to source control.

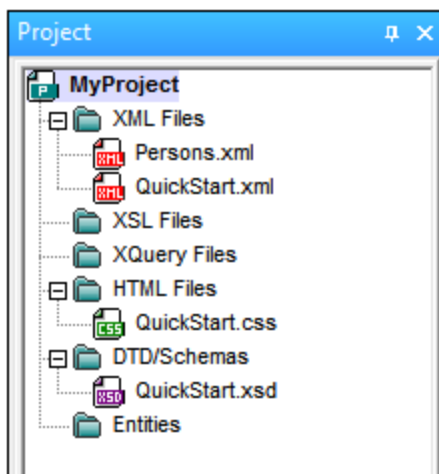



When files are added to source control, the local folder hierarchy is replicated in the repository (not the project folder hierarchy). So, if a file is in a sub-folder X levels deep in the local folder, then the file's parent folder and all other ancestor folders are automatically created in the repository.

When the first file from a project is added to source control, the correct bindings are created in the repository and the project file (.spp file) is added automatically. For more details, see the section [Add to Source Control](#)⁽⁷⁵⁰⁾.

Source control symbols

Files and the project folder display certain symbols, the meanings of which are given below.

| | |
|---|---|
|  | Checked in. Available for check-out. |
|  | Checked out by another user. Not available for check-out. |
|  | Checked out locally. Can be edited and checked-in. |

25.3.6.8 Remove from Source Control

To remove a file from source control, select the file and click the command **Project | Source Control | Remove from Source Control**. You can also remove: (i) files in a project folder by executing the command on the folder, (ii) multiple files that you select while keeping the **Ctrl** key pressed, and (iii) the entire project by executing the command on the project.

25.3.6.9 Share from Source Control

The **Share from Source Control** command is supported when the source control system being used supports shares. You can share a file, so that it is available at multiple local locations. A change made to one of these local files will be reflected in all the other "shared" versions.

In the application's Project window first select the project (*highlighted in the screenshot below*). Then click the **Share from Source Control**.

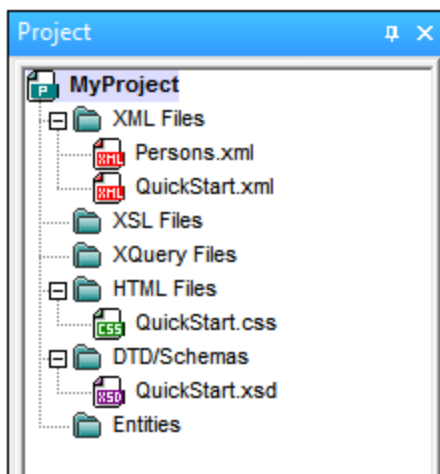

The Share To [Folder] dialog (*screenshot below*) pops up.

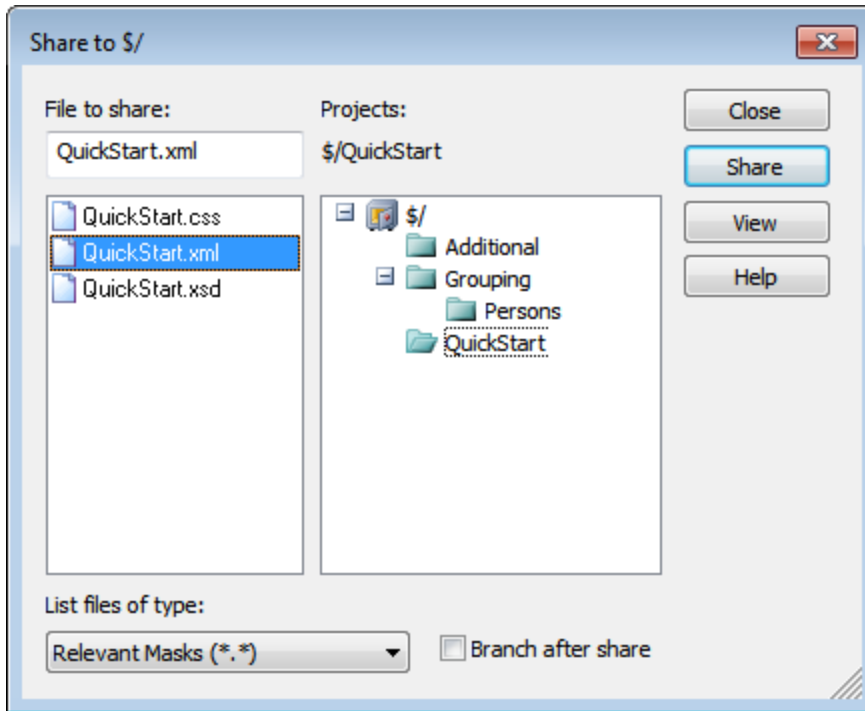

To select the files to share, first choose, in the project tree in the right hand pane, the folder in which the files are. The files in the chosen folder are displayed in the left hand pane. Select the file you wish to share (multiple files by pressing the **Ctrl** key and clicking the files you want to share). The selected file/s will be displayed in the *Files to Share* text box (*at top left*). Click **Share** and then **Close** to copy the selected file/s to the local share folder.

The share folder is noted in the name of the Share to [Folder] dialog. In the screenshot above it is the local folder (since the $\$$ sign is the folder in the repository to which the local folder is bound). You can see and set the share folder in the Change Source Control dialog (*screenshot below*, **Change Source Control**) by changing the local path and server binding.

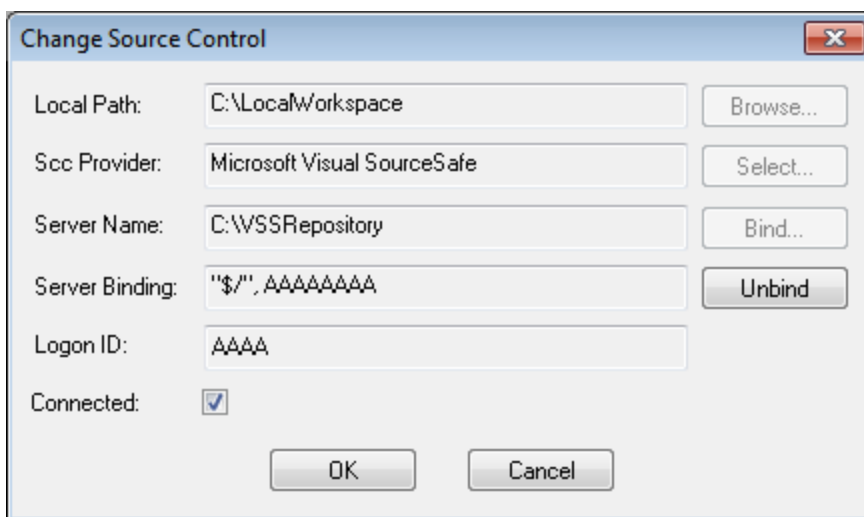

For more details about sharing using your source control system, see the source control system's user documentation.

25.3.6.10 Show History

The **Show History** command activates the Show History feature of the active source control system. It displays the history of the file selected in the Project window. Select the project title to display the history of the project file (.spp file). You can view information about previous versions of a file and differences, as well as retrieve previous versions of the file.

The screenshot below shows the History dialog of the Visual SourceSafe source control system. It lists the various versions of the `MyProject.spp` file.

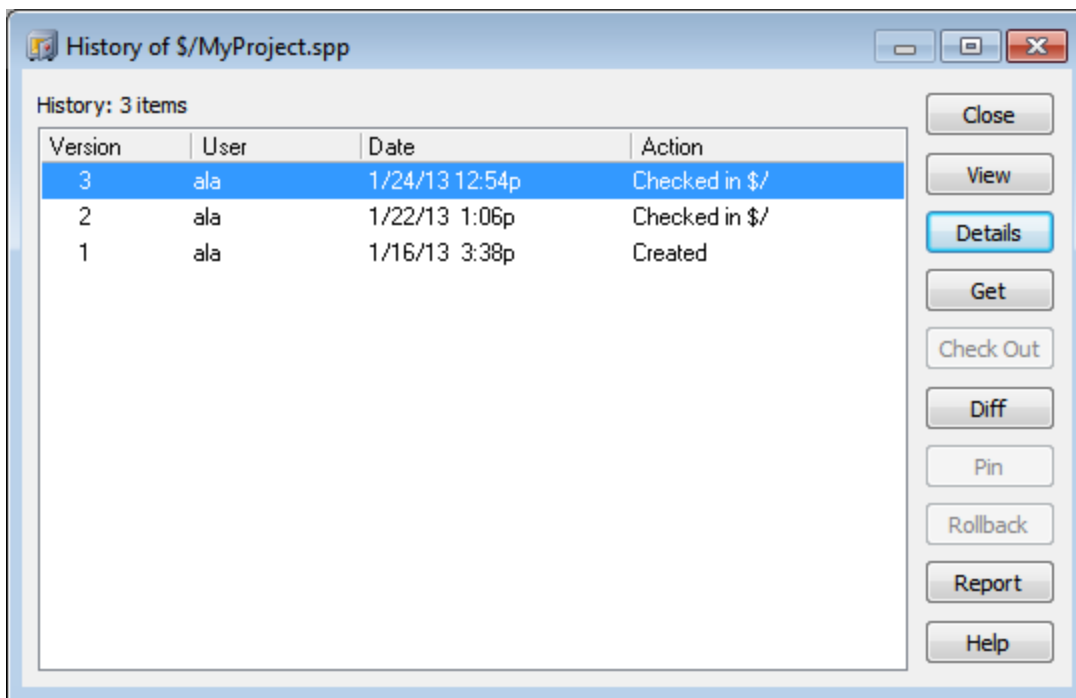

This History dialog provides various ways of comparing and getting specific versions of the file in question. Double-clicking an entry in the list opens the History Details dialog box for that file. The buttons in the History dialog provide the following functionality:

- *Close*: Closes this dialog box.
- *View*: Opens a dialog box in which you can select the type of file viewer.
- *Details*: Opens a dialog box in which you can see the [properties](#)⁸³⁸ of the currently active file.
- *Get*: Retrieves a previous file version and places it in the working directory.
- *Check Out*: Allows you to check out a previous version of the file.
- *Diff*: Opens the [Difference options](#)⁸³⁷ dialog box for differencing options between two file versions. Use **Ctrl+Click** to mark two file versions in this window, then click Diff to view the differences between them.

- *Pin*: Pins or unpins a version of the file, allowing you to define the specific file version to use when differencing two files.
- *Rollback*: Rolls back to the selected version of the file.
- *Report*: Generates a history report that you can send to a printer, file, or clipboard.
- *Help*: Opens the online help of the source control provider plugin.

25.3.6.11 Show Differences

The **Show Differences** command is enabled when a file in the Project window is selected. To select the project file (.spp file), select the project title in the Project window. The **Show Differences** command starts the source control system's differencing tool so that differences between files can be directly checked from your Altova application.

The screenshot below shows the differencing tool of the Visual SourceSafe source control system.

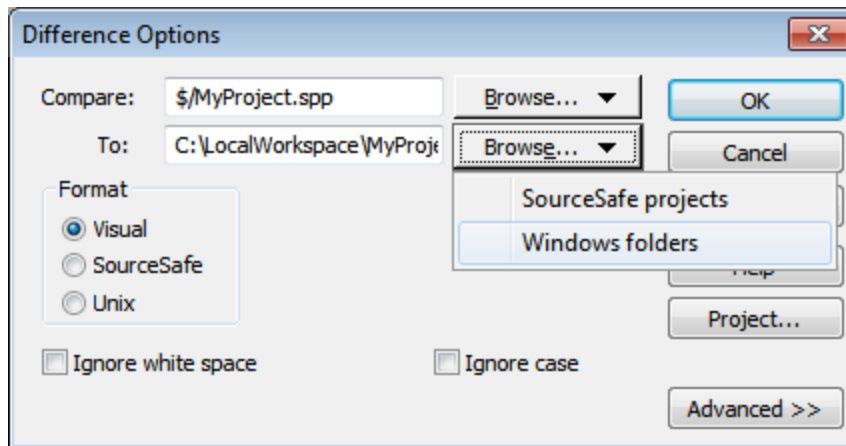

The repository and local versions are shown by default in the *Compare* and *To* text fields respectively. You can browse for other files as follows:

1. From the **Browse** button dropdown list, select SourceSafe projects (for browsing repository files) or Windows folders (for browsing local folders).
2. Browse for the files you want and select them.

Select the options you want and click **OK** to run the check. The differencing results are displayed in a separate window. The screenshots below show the results of a check in two formats.

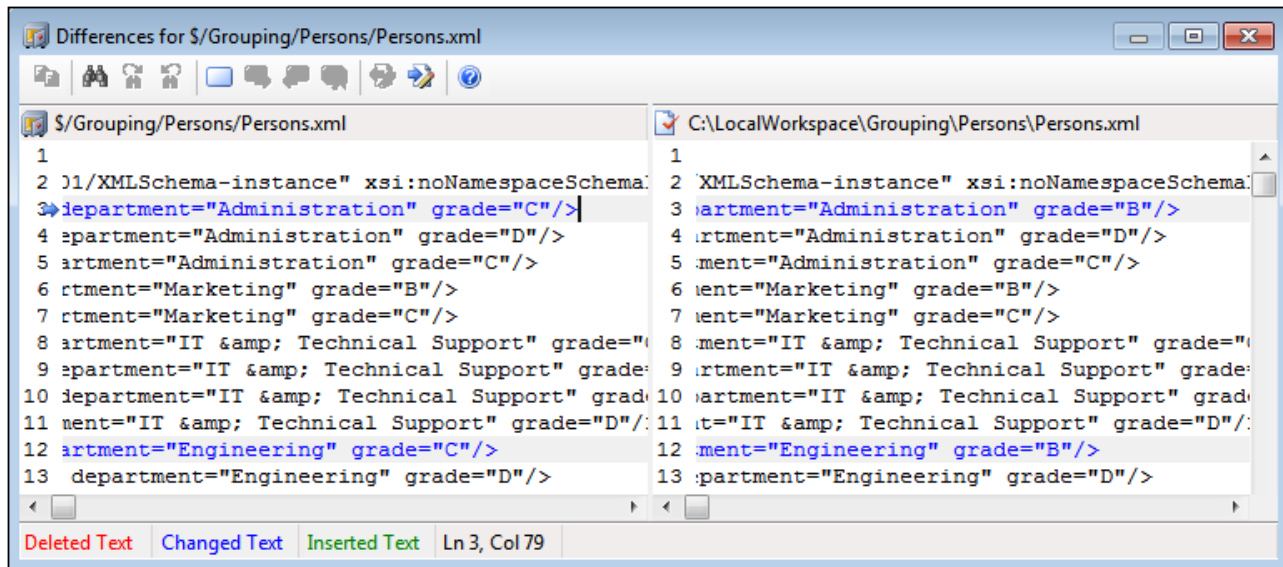

The screenshot above shows the Visual SourceSafe differencing result in Visual format (see *Options dialog* above), while the screenshot below shows the result in Unix format. In both, there are two differences, each of which is a change of the grade from C to B.

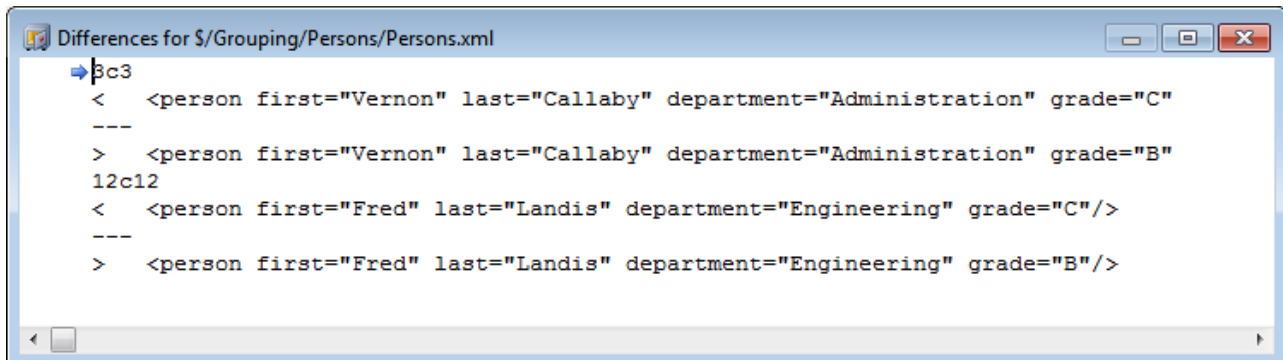

For a detailed description of how your source control system handles differencing, see the product's user documentation.

25.3.6.12 Show Properties

The **Show Properties** command displays the properties of the currently selected file (*screenshot below*). What properties are displayed depends on the source control system you are using. The screenshot below shows properties when Visual SourceSafe is the active source control system.

Note that this command is enabled only for single files.

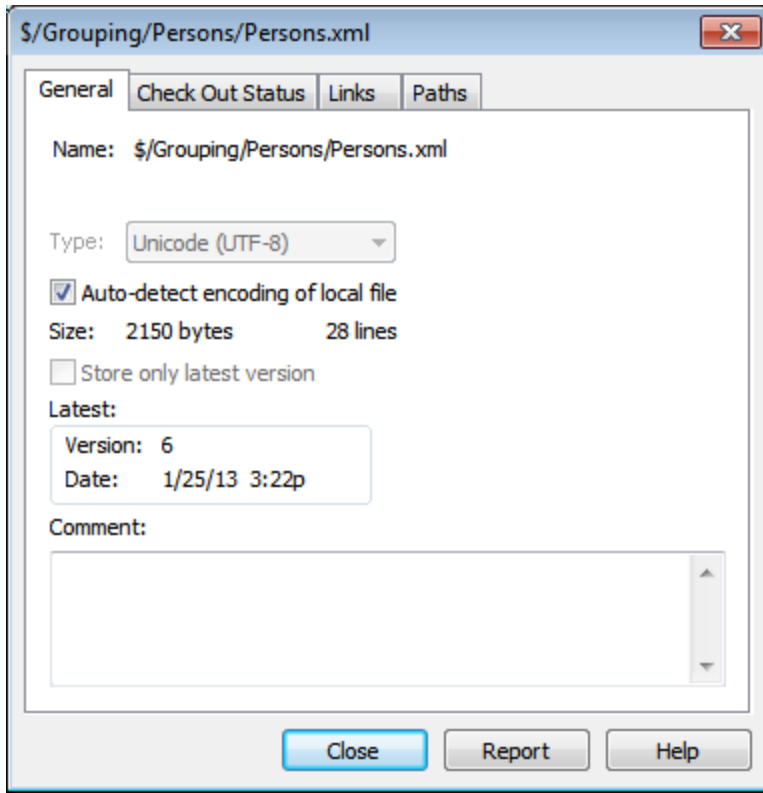

For details, see the source control system's user documentation.

25.3.6.13 Refresh Status

The **Refresh Status** command refreshes the status of all project files independent of their current status.

25.3.6.14 Source Control Manager

The **Source Control Manager** command starts your source control software with its native user interface.

25.3.6.15 Change Source Control

The current binding is what the active application project will use to connect to the source control database, so the current binding must be correct. By this is meant that the application project file (`.spp` file) must be in the local path folder and the bound folder on the repository must be the database where this project's files are stored. Typically the bound folder and its sub-structure will correspond with the local workspace folder and its sub-structure.

In the Change Source Control dialog (*screenshot below*), you can change the source control system (*SCC Provider*), the local folder (*Local Path*), and the repository binding (*Server Name* and *Server Binding*).

Only after unbinding the current binding can the settings be changed. Unbind the current binding with the **Unbind** button. All the settings are now editable.

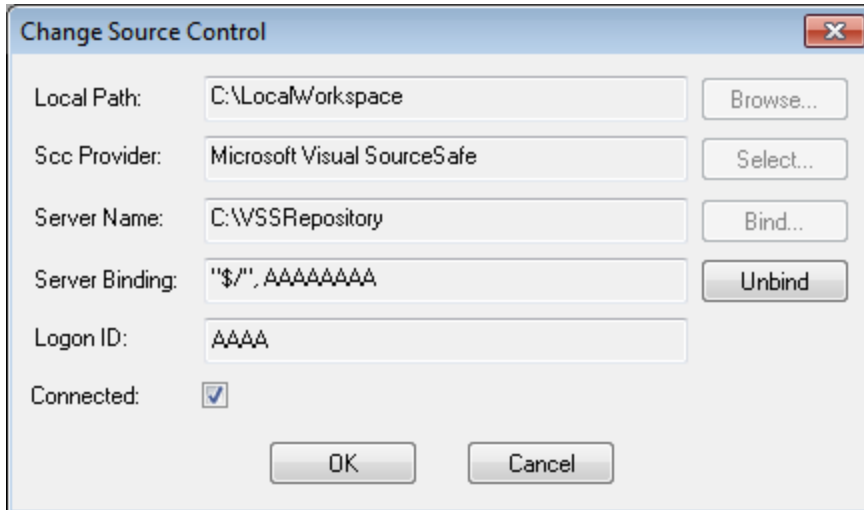

Change source control settings as follows:

1. Use the **Browse** button to browse for the local folder and the **Select** button to select from among the installed source control systems.
2. After doing this you can bind the local folder to a repository database. Click the **Bind** button to do this. This pops up the connection dialog of your source control system.
3. If you have entered a *Logon ID*, this will be passed to the source control system; otherwise you might have to enter your logon details in the connection dialog.
4. Select the database in the repository that you wish to bind to this local folder. This setting might be spread over more than one dialog.
5. After the setting has been created, click **OK** in the Change Source Control dialog.

25.3.7 Add Files to Project



The **Project | Add Files to Project** command adds files to the current project. Use this command to add files to any folder in your project. You can either select a single file or any group of files (using **Ctrl+ click**) in the Open dialog box. If you are adding files to the project, they will be distributed among the respective folders based on the File Type Extensions defined in the [Project Properties](#) ⁸⁴⁹ dialog box.

25.3.8 Add Global Resource to Project

The **Project | Add Global Resource to Project** command pops up the Choose Global Resource dialog, in which you can select a global resource of file or folder type to add to the project. If a file-type global resource is selected, then the file is added to the appropriate folder based on the File Type Extensions defined in the [Project Properties](#)⁸⁴⁹ dialog box. If a folder-type global resource is selected, that folder will be opened in a file-open dialog and you will be prompted to select a file; the selected file is added to the appropriate folder based on the File Type Extensions defined in the [Project Properties](#)⁸⁴⁹ dialog box. For a description of global resources, see the Global Resources section in this documentation.

25.3.9 Add URL to Project



The **Project | Add URL to Project** command adds a URL to the current project. URLs in a project cause the target object of the URL to be included in the project. Whenever a batch operation is performed on a URL or on a folder that contains a URL object, XMLSpy retrieves the document from the URL, and performs the requested operation.

25.3.10 Add Active File to Project



The **Project | Add Active File to Project** command adds the active file to the current project. If you have just opened a file from your hard disk or through an URL, you can add the file to the current project using this command.

25.3.11 Add Active And Related Files to Project



The **Project | Add Active and Related Files to Project** command adds the currently active XML document and all related files to the project. When working on an XML document that is based on a DTD or Schema, this command adds not only the XML document but also all related files (for example, the DTD and all external parsed entities to which the DTD refers) to the current project.

Please note: Files referenced by processing instructions (such as XSLT files) are not considered to be related files.

25.3.12 Add Project Folder to Project



The **Project | Add Project Folder to Project** command adds a new folder to the current project. Use this command to add a new folder to the current project or a sub-folder to a project folder. You can also access this command from the context-menu when you right-click on a folder in the project window.

Note: A project folder can be dragged and dropped into another project folder or to any other location in the project. Also, a folder can be dragged from Windows (File) Explorer and dropped into any project folder.

Note: Project folders are green, while [external folders](#)⁸⁴² are yellow.

25.3.13 Add External Folder to Project

The **Project | Add External Folder to Project** command adds a new external folder to the current project. Use this command to add a local or network folder to the current project. You can also access this command from the context-menu when you right-click a folder in the project window.

Note: External folders are yellow, while [project folders](#)⁸⁴² are green.

Note: Files contained in external folders cannot be placed under source control.

Adding external folders to projects

To add an external folder to the project:

1. Select the menu command **Project | Add External Folder to Project**.
2. Select the folder you want to include and click **OK** to confirm. The selected folder now appears in the Project window.

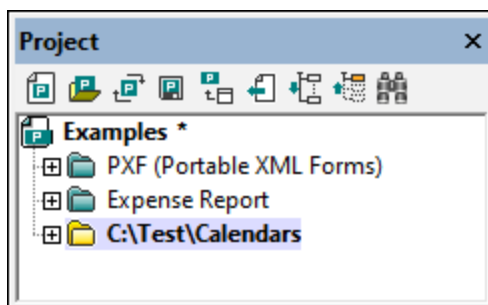

3. Click the plus icon to view the folder contents.

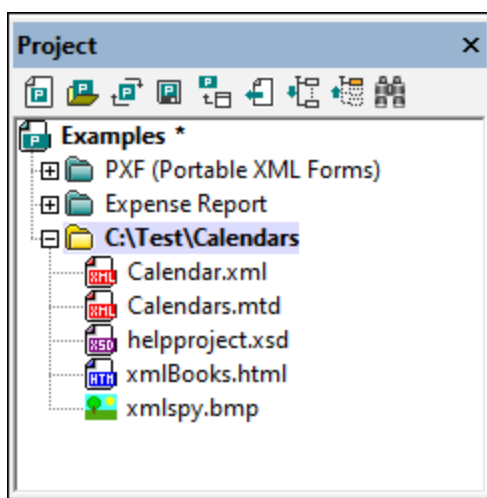

Filtering contents of folders

To filter the contents of the folder:

1. Right-click the external folder that you added, and select **Properties**. This opens the Properties dialog box.

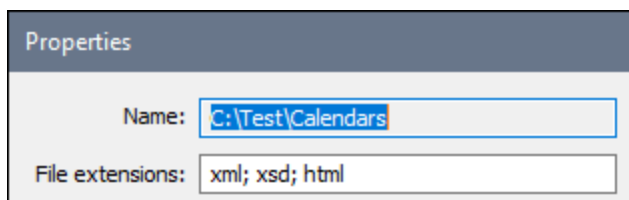

2. Click in the *File extensions* field and enter the file extensions of the file types you want to see, separating file types with a semicolon (see screenshot above).
3. Click **OK** to confirm.

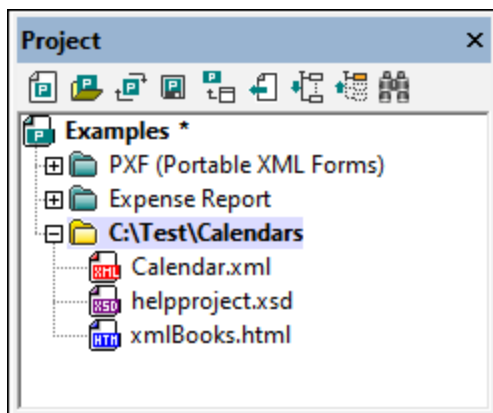

The Project window now only shows the selected file types.

Validating external folders

To validate and check an external folder for well-formedness:

1. Select the file types you want to see or check from the external folder.
2. Select the folder and click the menu command **XML | Check well-formedness** or **Validate XML** (hotkey **F7** or **F8**, respectively). All the files visible under the folder are checked. If a file is malformed or invalid, then this file is opened in the Main Window, allowing you to edit it.
3. Correct the error and run the validation process once more to recheck.

Updating a project folder

You might add or delete files in the local or network directory at any time. To update the folder view, right-click the external folder, and select the popup menu option **Refresh**.

Deleting external folders and files in them

Select an external folder and press the **Delete** key to delete the folder from the Project window. Alternatively, right-click the external folder and select the **Delete** command. Each of these actions only deletes the external folder from the Project window. The external folder is not deleted from the hard disk or network.

To delete a file in an external folder, you have to delete it physically from the hard disk or network. To see the change in the project, refresh the external folder contents (right-click the external folder and select **Refresh**).

Note: An external folder can be dragged and dropped into a project folder or to any other location in the project (but not into another external folder). Also, an external folder can be dragged from Windows (File) Explorer and dropped into any location in the project window except into another external folder.

25.3.14 Add External Web Folder to Project

This command adds a new external web folder to the current project. You can also access this command from the context-menu when you right-click a folder in the project window. Note that files contained in external folders cannot be placed under source control.

Adding an external web folder to the project

To add an external web folder to the project, do the following:

1. Select the menu option **Project | Add External Web Folder to Project**. This opens the Add Web Folder to Project dialog box (*screenshot below*).

The screenshot shows a dialog box titled "Add Web Folder to Project". It features a "File URL" dropdown menu. Below this is an "Identification" section with "User" (MyDocs) and "Password" (masked with dots) fields, and a checked "Remember password between application starts" checkbox. The "Available files" section includes a "Server URL" dropdown (http://vietsptest/) and a "Browse" button. There is an unchecked checkbox for "This is a Microsoft SharePoint Server". At the bottom, there are "New Folder", "Delete", "Open", and "Cancel" buttons.

2. Click in the Server URL field and enter the URL of the server URL. If the server is a Microsoft® SharePoint® Server, check this option. See the *Folders on a Microsoft® SharePoint® Server* section below for further information about working with files on this type of server.
3. If the server is password-protected, enter your User ID and password in the *User* and *Password* fields.
4. Click **Browse** to connect to the server and view the available folders.

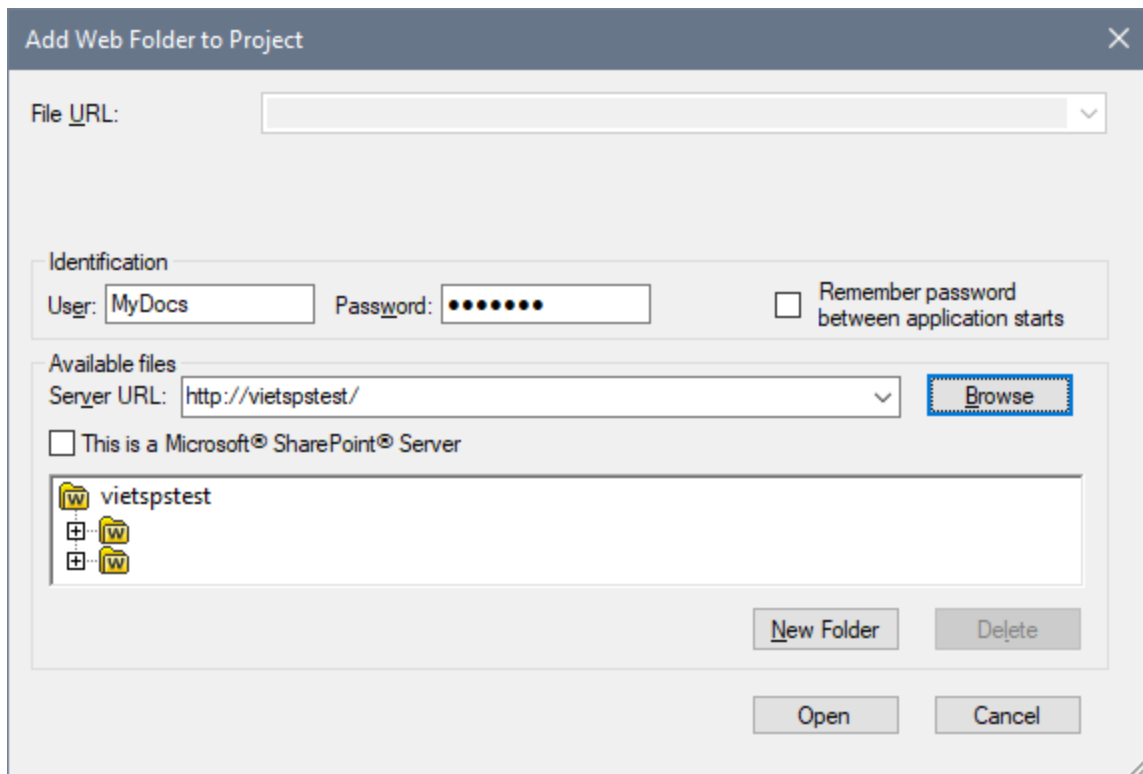

5. Click the folder you want to add to the project view. The **Open** button only becomes active once you do this. The URL of the folder now appears in the File URL field.
6. Click **Open** to add the folder to the project.

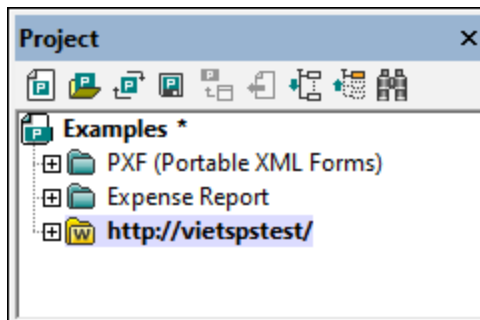

7. Click the plus icon to view the folder contents.

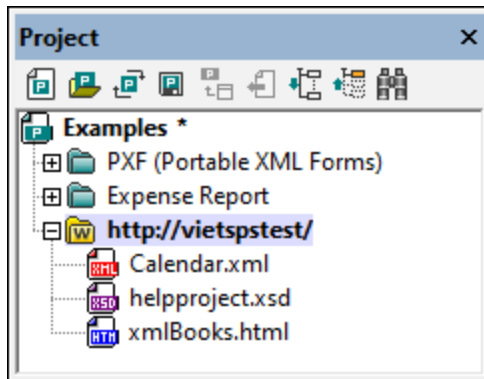

Filtering folder contents

To filter the contents of a folder, right-click the folder and select **Properties** from the context menu. In the Properties dialog that pops up, click in the *File Extensions* field and enter the file extensions of the file types you want to see (for example, XML and XSD files). Separate each file type with a semicolon (for example: `xml; xsd; sps`). The Project window will now show that folder only with files having the specified extension.

Validating and checking a folder for well-formedness

To check the files in a folder for well-formedness or to validate them, select the folder and then click the menu command **XML | Check well-formedness** or **XML | Validate XML** icon (hotkey **F7** or **F8**, respectively). All the files that are visible in the folder are checked. If a file is malformed or invalid, then this file is opened in the main window, allowing you to edit it. Correct the error and restart the process to recheck the rest of the folder. Note that you can select discontinuous files in the folder by holding **Ctrl** and clicking the files singly. Only these files are then checked when you press **F7** or **F8**.

Updating the contents of the project folder

Files may be added or deleted from the web folder at any time. To update the folder view, right-click the external folder and select the context menu option **Refresh**.

Deleting folders and files

Since it is the Web folder that has been added to the project, it is only the Web folder (and not files within it) that can be deleted from the project. You can delete a Web folder from a project, by either (i) right-clicking the folder and selecting **Delete**, or (ii) selecting the folder and pressing the **Delete** key. This only deletes the folder from the Project view; it does not delete anything on the web server.

Note: Right-clicking a single file and pressing the **Delete** key does not delete a file from the Project window. You have to delete it physically on the server and then refresh the contents of the external folder.

Folders on a Microsoft® SharePoint® Server

When a folder on a Microsoft® SharePoint® Server has been added to a project, files in the folder can be checked out and checked in via commands in the context menu of the file listing in the Project window (see *screenshot below*). To access these commands, right-click the file you wish to work with and select the command you want (**Check Out**, **Check In**, **Undo Check Out**).

The User ID and password can be saved in the [properties of individual folders in the project](#)⁸⁴⁹, thereby enabling you to skip the verification process each time the server is accessed.

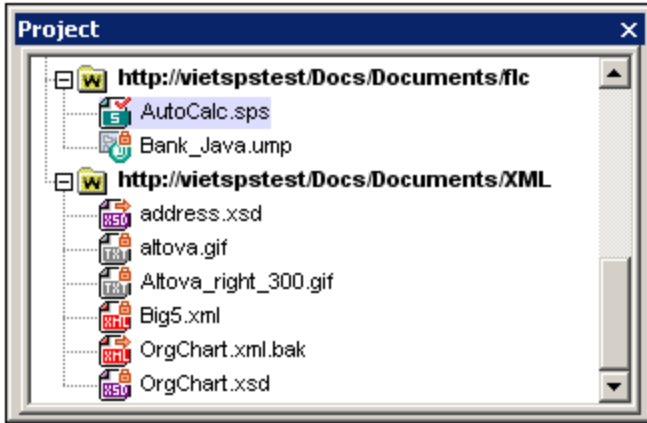

In the Project window (*screenshot below*), file icons have symbols that indicate the check-in/check-out status of files. The various file icons are shown below:

| | |
|--|---|
| | Checked in. Available for check-out. |
| | Checked out by another user. Not available for check-out. |
| | Checked out locally. Can be edited and checked-in. |

The following points should be noted:

- After you check out a file, you can edit it in your Altova application and save it using **File | Save (Ctrl+S)**.
- You can check-in the edited file via the context menu in the Project window (*see screenshot above*), or via the context menu that pops up when you right-click the file tab in the Main Window of your application (*screenshot below*).

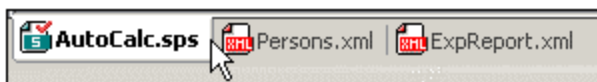

- When a file is checked out by another user, it is not available for check out.
- When a file is checked out locally by you, you can undo the check-out with the Undo Check-Out command in the context menu. This has the effect of returning the file unchanged to the server.
- If you check out a file in one Altova application, you cannot check it out in another Altova application. The file is considered to be already checked out to you. The available commands at this point in any Altova application supporting Microsoft® SharePoint® Server will be: **Check In** and **Undo Check Out**.

25.3.15 Script Settings

A scripting project is assigned to an XMLSpy project as follows:

1. In the XMLSpy GUI, open the required application project.
2. Select the menu command **Project | Script Settings**. The Scripting dialog (*screenshot below*) opens.

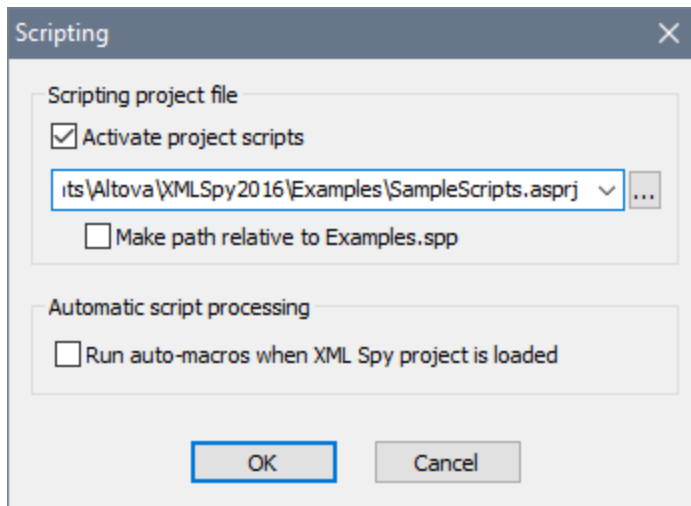

3. Check the *Activate Project Scripts* check box and select the required scripting project (`.asprj` file). If you wish to run Auto-Macros when the XMLSpy project is loaded, check the *Run Auto-Macros* check box.
4. Click **OK** to finish.

Note: To deactivate (that is, unassign) the scripting project of an XMLSpy project, uncheck the *Activate Project Scripts* check box.

25.3.16 Properties



The **Project | Project Properties** command opens the Properties dialog (*screenshot below*) of the active project. If you right-click a folder in the Project window (as opposed to the project folder itself) and select **Properties**, the Properties dialog of that folder is opened. The dialog settings are described below.

Note: If your project file is under source control, a prompt appears asking if you want to check out the project (`.spp`) file. Click **OK** if you want to edit settings and be able to save them.

Properties

Name:

File

Validation

Validate with:

XSL transformation of XML files

Use this XSL:

XSL:FO transformation of XML files

Use this XSL:

XQuery/Update transformation of XML files

Use this XQuery:

Input XML for XSL/XQuery/Update transformation

Use this XML:

Output files for XSL/XQuery/Update transformation

Save in folder:

File extension:

XULE execution

Use this XBRL:

Authentic view

Use config.:

JSON conformant files

Treat as:

Settings

File extensions

The *File Extensions* setting is enabled for individual folders, and not for the project folder. When a file is added to a project, it will be added to the folder on which its file extension has been defined. For example, say a file named `MyReport.xml` is added to the project. If `.xml` file extensions have been set on the `Invoices-EU` folder (as shown in the screenshot above), then `MyReport.xml` will be added to the `Invoices-EU` folder. If there is more than one folder to which you wish to add XML files, then you should add individual XML files directly to the folder (instead of to the project).

User ID and password for external folders

On external folders (including external Web folders), you can save the user ID and password that might be required for accessing the server.

Validation

The DTD, XML Schema, or [JSON schema](#)⁵⁶¹ that should be used to [validate](#)⁸⁵⁷ the files in the current folder (or entire project if the properties are those of the project).

XSL transformation of XML files

The XSLT stylesheet to be used for [XSLT transformation](#)⁹⁰⁷ of XML files in the folder.

XSL-FO transformation of XML files

The XSLT stylesheet to transform XML files in the folder to XSL-FO.

XQuery/Update transformation of XML files

The XQuery or XQuery Update file to be used for XQuery executions or XQuery Update executions of XML files in the folder.

Input XML for XSL/XQuery/Update transformation of XML files

The XML file to use as input for XSLT transformations or XQuery/XQuery Update executions with the respective XSLT, XQuery, or XQuery Update files in the folder.

Output files for XSL/XQuery/Update transformation

The destination directory of transformations, and, optionally, the file extension of the result document.

XULE execution

The XBRL instance file to process with the XULE document that is active in the XMLSpy application window.

Authentic View

The *Use config* specifies the StyleVision Power Stylesheet (SPS file) to use for the Authentic View display of XML files in the folder. Note that the XML file must be valid against the same schema used for the SPS.

JSON conformant files

This property specifies whether a project folder contains JSON Schema files or JSON instance files. It can be very useful to help identify JSON Schema files if the files are not clearly identified as a JSON Schema file by the `$schema` keyword and the files reference each other. You can set it to *JSON Instance*, *JSON Schema*, or *Auto detect*. The default setting of *Auto-detect* would cause XMLSpy to check the structure and content of JSON files to determine its type.

Notes about project properties

Note the following points about precedence:

- When validations or XSLT/XQuery transformations are carried out via project folder context menus, then the validation or transformation files specified in this dialog take precedence over any assignment in the XML file. Also, settings specified for individual project folders take precedence over settings specified for ancestor folders.
- If one file is present in multiple folders of the project and has been assigned different validation or transformation files in the different folders, then you can set which assignment to use when the file is processed outside the project. Specify this as follows: Locate the file in the project folder whose assignment/s you wish to use. Right-click the file in that project folder, and select **Properties**. In the dialog that appears (*screenshot below*), select *Use settings in current folder as default*. (The current folder is the project folder in which the file is located.) If the option is disabled, it means that the settings of the current folder are already selected as the default settings to use. If you select a file instance that is in a project folder that is not the default, then the option is enabled, and you can switch the default settings to be this folder's settings. Note that, if the file has a local assignment (that is, an assignment within the file itself), then the local assignment will be used, and the default folder settings will be ignored.

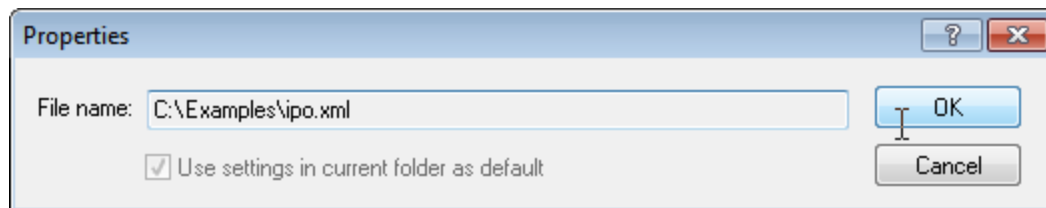

25.3.17 Most Recently Used Projects

This command displays the file name and path for the nine most recently used projects, allowing quick access to these files.

Also note, that XMLSpy can automatically open the [last project](#)¹⁰⁴¹ that you used, whenever you start XMLSpy. (**Tools | Options | File** section, **Project | Open last project on program start**).

25.4 XML Menu

The **XML** menu contains commands that are commonly used when working with XML documents. You will find commands to insert or append elements, modify the element hierarchy, set a namespace prefix, as well as to evaluate XPath expressions in the context of individual XML documents.

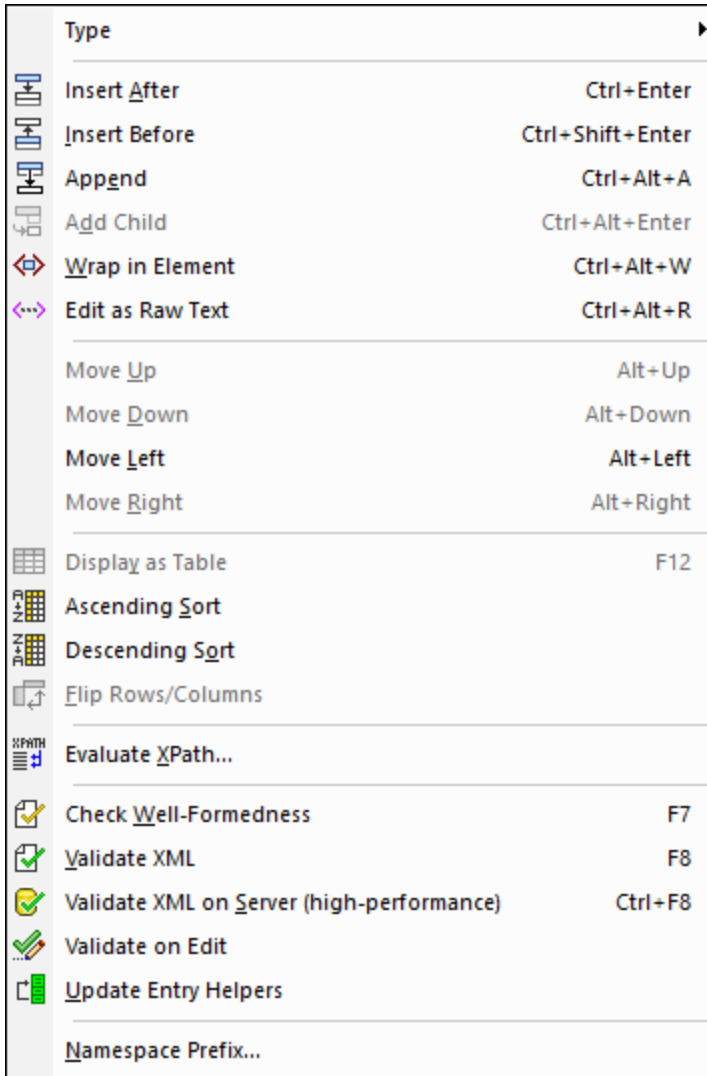

Among the most frequently used XML tasks are checks for the [well-formedness](#)⁸⁵⁶ of documents and [validity](#)⁸⁵⁷ of XML documents. Commands for these tasks are in this menu.

25.4.1 Type

The **Type** command has a submenu that contains a list of XML node types. You can change the type of the node currently selected in Grid View to a new type from this list. The node types in the submenu become enabled in Grid View only, and only those node types are enabled to which the currently selected node can be changed.

See the topic [XML | Document Content](#)¹⁵⁶ for more information.

25.4.2 Insert After/Before

The **Insert After** and **Insert Before** commands are enabled when a node in Grid View is selected. They add an element node at the same level, respectively, after and before the selected item. Change the name of the newly added element by double-clicking in its name cell and editing. Change the node type by clicking the element's icon (to the left of its name) and selecting the node type you want, or by using the command [XML | Type](#)⁸⁵³.

See the topic [XML | Document Structure](#)¹⁵⁵ for more information.

25.4.3 Append, Add Child

The **Append** and **Add Child** commands are enabled when a node in Grid View is selected. The **Append** command adds a new element node as the last sibling of the selected item. The **Add Child** command appends a new element node as a child. Change the name of the newly added element by double-clicking in its name cell and editing. Change the node type by clicking the element's icon (to the left of its name) and selecting the node type you want, or by using the command [XML | Type](#)⁸⁵³.

See the topic [XML | Document Structure](#)¹⁵⁵ for more information.

25.4.4 Wrap in Element

The **Wrap in Element** command is enabled when a node in Grid View is selected. The selected node is given a parent element with a default name. Change the name of the newly added parent element by double-clicking in its name cell and editing.

See the topic [XML | Document Structure](#)¹⁵⁵ for more information.

25.4.5 Edit as Raw Text

The **Edit as Raw Text** command is enabled when a node in Grid View is selected. It enables you to edit text content of the selected item as raw text. This is useful, for instance, if you are editing complex content such as HTML code.

For more information, see the section [XML in Grid View](#)²⁹⁰.

25.4.6 Move Up/Down/Left/Right

These **Move** commands are enabled when a node in Grid View is selected. If it is possible to move the node up, down, left or right from its current location in the grid, then the corresponding command/s are enabled. Select the respective command to carry out the move.

25.4.7 Display as Table

The **Display as Table** command is enabled when a repeating element in Grid View is selected. It is a toggle command that switches the display of the set of repeating elements between standard [Grid View](#)¹⁴⁶ and [Table Display](#)¹⁶³. Table Display enables you to view repeated elements as a table in which the rows represent the occurrences while the columns represent child nodes.

See the topic [Table Display \(XML\)](#)¹⁶³ for more information.

25.4.8 Ascending/Descending Sort

The **Ascending Sort** and **Descending Sort** commands are enabled in [Table Display](#)¹⁶³ when a column or cell is selected. They sort the selected column in either alphabetic or numeric ascending/descending order, depending to the datatype of the column.

See the topic [Table Display \(XML\)](#)¹⁶³ for more information.

25.4.9 Flip Rows/Columns

The **Flip Rows/Columns** command is enabled in [Table Display](#)¹⁶³ when the top left cell of a table is selected (marked in red in screenshot below). The command switches rows to columns and vice versa.



| | = type | = expto | <> Date | <> expense |
|---|---------------|-------------|------------|------------|
| 1 | Lodging | Sales | 2003-01-01 | 122.11 |
| 2 | Lodging | Development | 2003-01-02 | 122.12 |
| 3 | Lodging | Marketing | 2003-01-02 | 299.45 |
| 4 | Entertainment | Development | 2003-01-02 | 13.22 |

See the topic [Table Display \(XML\)](#)¹⁶³ for more information.

25.4.10 Evaluate XPath



The **XML | Evaluate XPath** command opens the Output Windows if these are not open and activates the [XPath Window in the Output Windows](#)¹¹⁵. In the XPath tab, you can evaluate an XPath expression on the active document and see the results in the Output Window.

25.4.11 Check Well-Formedness



F7

The **XML | Check well-formedness (F7)** command checks the active document for well-formedness by the definitions of the XML 1.0 specification. Every XML document **must** be well-formed. XMLSpy checks for well-formedness whenever a document is opened or saved, or when the view is changed from Text View to any other view. You can also check for well-formedness at any time while editing by using this command.

If the well-formedness check succeeds, a message is displayed in the Messages window (*screenshot below*).

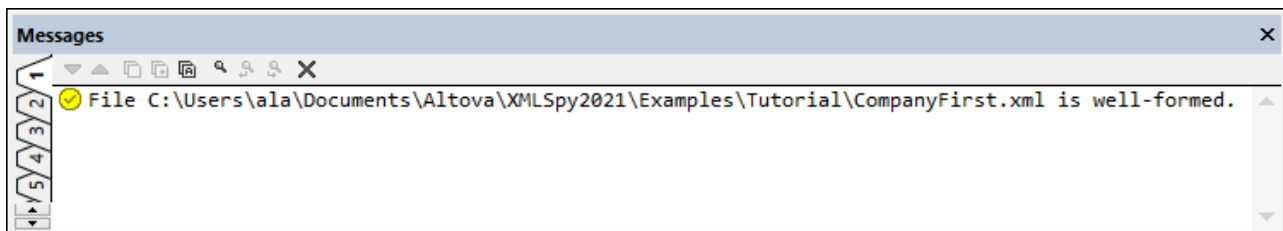

If an error is encountered during the well-formedness check, a corresponding error message is displayed (*screenshot below*).

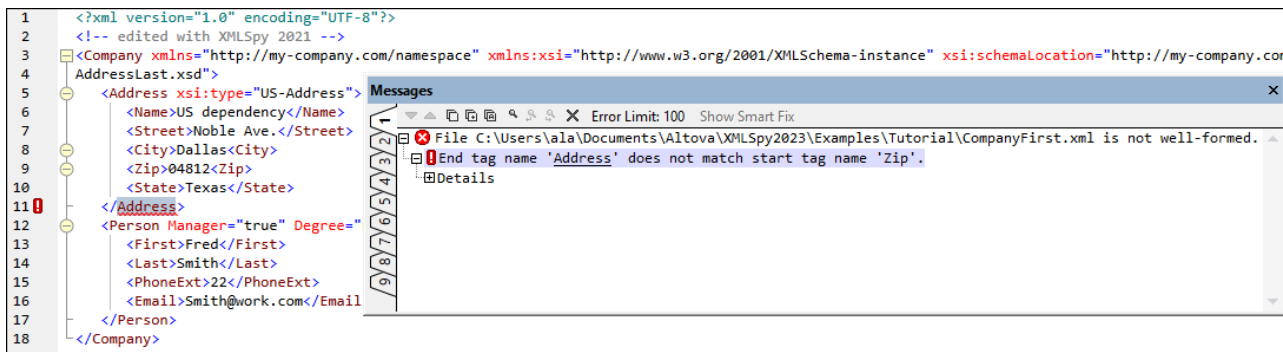

Note that errors in the Messages window are displayed one error at a time.

Note: The Messages window has nine tabs. The validation result is always displayed in the active tab. So you can validate one XML document in Tab-1 and retain the result in that tab. To validate a second document, switch to Tab-2 (or Tab-3 if you like) before running the check. If you do not switch tabs, Tab-1 (or the active tab) will be overwritten with the results of the latest validation.

Validating from the Project window

The **Validate** command can also be applied to a file, folder, or group of files in the active project. Select the required file or folder in the Project Window (by clicking on it). Then click [XML | Validate XML](#)⁸⁵⁷. You can also use the [Validate XML on Server \(high-performance\)](#)⁸⁶¹ command. Invalid files in a project will be opened and made active in the Main Window, and the *File is not valid* error message will be displayed.

Note: The Messages window has nine tabs. The result of the well-formed check is always displayed in the active tab. So you can check the well-formedness of one XML document in Tab-1 and retain the result in that tab. To check the well-formedness of a second document, switch to Tab-2 (or Tab-3 if you like) before running the check. If you do not switch tabs, Tab-1 (or the active tab) will be overwritten with the results of the latest check.

It is generally not permitted to save a malformed XML document, but XMLSpy gives you a Save Anyway option. This is useful when you want to suspend your work temporarily (in a not well-formed condition) and resume it later.

Note: You can also use the **Check well-formedness** command on any file, folder, or group of files in the active [project window](#)¹¹⁰. Click on the respective item, and then on the Check Well-Formedness icon.

25.4.12 Validate XML



F8

The **XML | Validate (F8)** command enables you to validate XML documents against DTDs, XML Schemas, and other schemas. Validation is automatically carried out when you switch from Text View to any other view. You can specify that a document be automatically validated when a file is opened or saved (**Tools | Options | File**). The **Validate** command also carries out a well-formedness check before checking validity, so there is no need to use the [Check Well-Formedness](#)⁸⁵⁶ command before using the **Validate** command.

Note: You can also toggle on the [Validate on Edit](#)⁸⁶³ command to validate as you edit data.-

If a document is valid, a successful validation message is displayed in the Messages window.

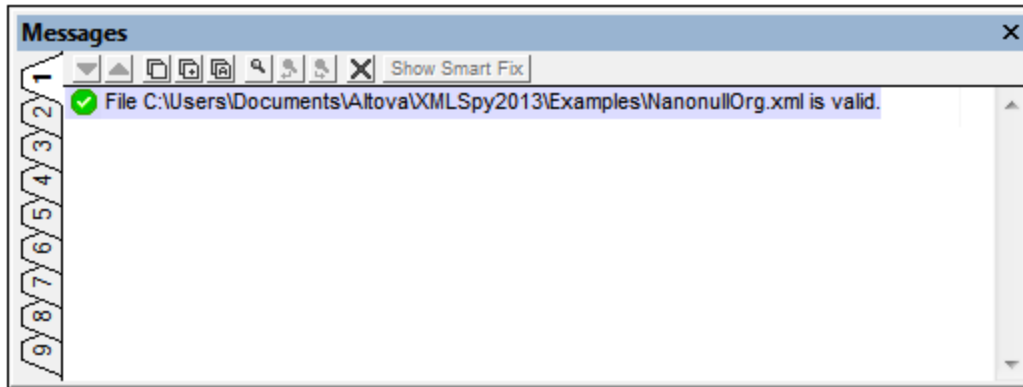

Otherwise, a message that describes the error is displayed. You can click on the links in the error message to jump to the node in the XML document where the error was found. See the next section below for a description of the error message and how to fix validation errors with the smart fixes of XMLSpy.

Validation errors and their fixes

When a validation error is displayed in the Messages window, the causes of the error are displayed in the left-hand pane (see screenshot below). If a cause is selected in the left-hand pane, then smart fixes for it, if available, are displayed in the right-hand pane. Smart fix suggestions are available in **Text View** and **Grid View**, and are based on information in the associated schema. To view smart fixes, click the **Show Smart Fix** button. Click **Hide Smart Fix** if you do not want these suggestions to be displayed. Note that errors of well-formedness (such as mismatched start and end tags), if such exist, are displayed prior to validation errors being displayed. So the **Show/Hide Smart Fix** button will be enabled only when a validation error is reached (that is, after all well-formedness errors have been corrected).

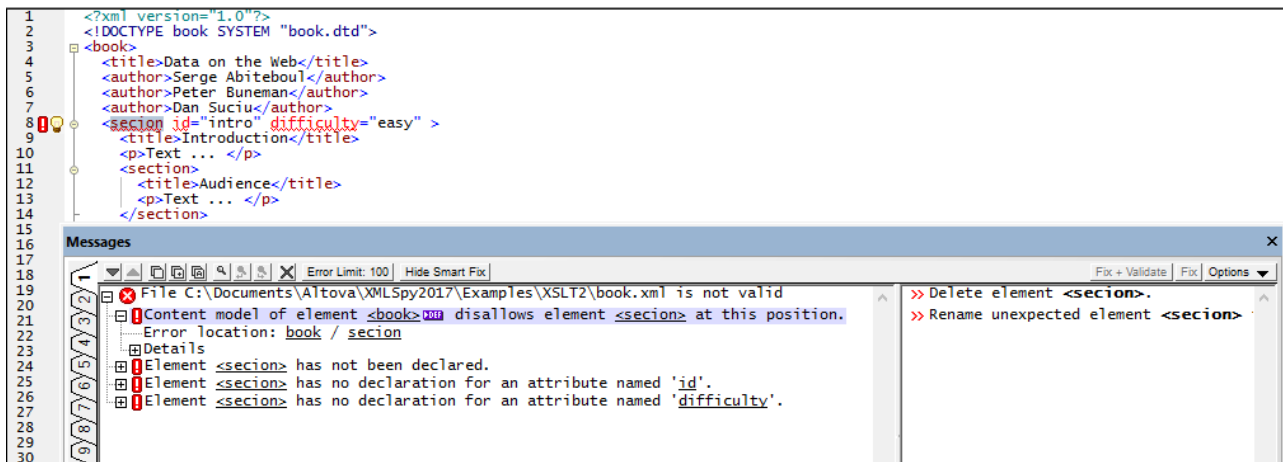

To apply a smart fix, either (i) double-click it, or (ii) select it and click either the **Fix** or **Fix + Validate** options (see screenshot below). The **Fix + Validate** command will validate beyond the fixed error and pick up the next error, if there is any.

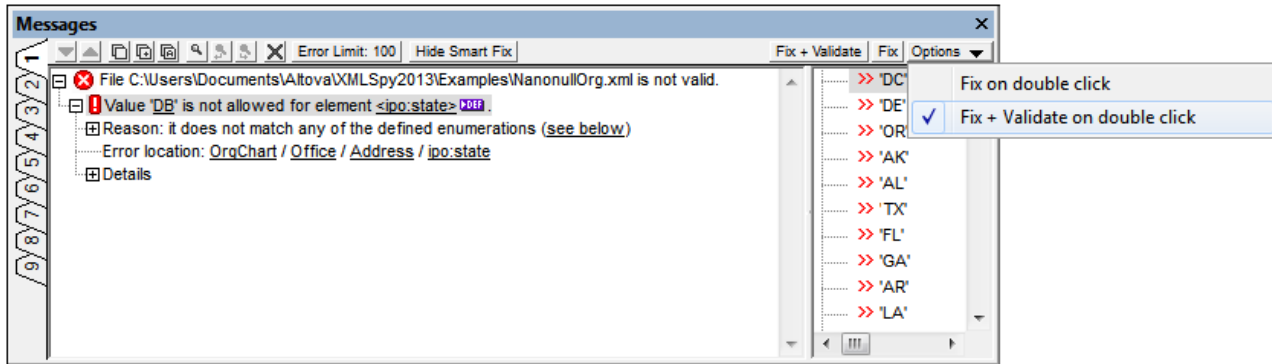

In Text View, there are two additional indicators of a validation error (see screenshot below): (i) a red exclamation-mark icon in the line-numbering margin, and (ii) a red marker-square in the scroll bar (on the right of the window).

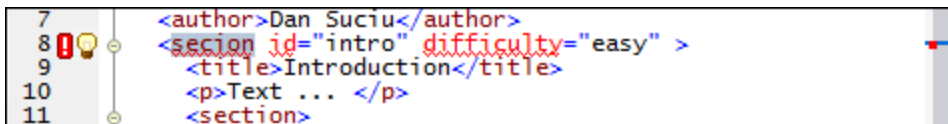

The light-bulb icon next to the exclamation-mark icon (see screenshot above) is the smart-fix icon. If you hover over it, all smart fixes across all causes of the error are displayed (see screenshot below). Select a smart fix to apply it.

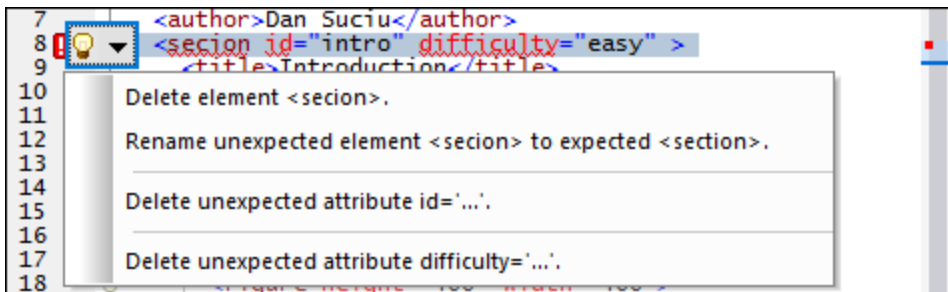

Note: The validation error indicators and smart fixes described above are refreshed only when the **XML | Validate (F8)** command is executed; they are not updated in the background. So, after correcting an error, you must run the **Validate (F8)** command again to make sure that the error has indeed been fixed.

Note: The Messages window has nine tabs. The validation result is always displayed in the active tab. So you can validate one XML document in Tab-1 and retain the result in that tab. To validate a second document, switch to Tab-2 (or Tab-3 if you like) before running the check. If you do not switch tabs, Tab-1 (or the active tab) will be overwritten with the results of the latest validation.

Validating from the Project window

The **Validate** command can also be applied to a file, folder, or group of files in the active project. Select the required file or folder in the Project Window (by clicking on it). Then click **XML | Validate** or **F8**. Invalid files in a

project will be opened and made active in the Main Window, and the *File is not valid* error message will be displayed..

Validating XML documents

To validate an XML file, make the XML document active in the Main Window, and click **XML | Validate** or **F8**. The XML document is validated against the schema referenced in the XML file. If no reference exists, an error message is displayed in the Messages window. As long as the XML document is open, the schema is kept in memory (see [Flush Memory Cache](#)⁸⁸³ in the DTD/Schema menu).

Validating schema documents (DTDs and XML Schema)

XMLSpy supports major schema dialects, including DTD and XML Schema. To validate a schema document, make the document active in the Main Window, and click **XML | Validate** or **F8**.

Validation messages

There are two kinds of messages:

- If the schema (DTD or XML Schema) is valid, a successful validation message is displayed in the Messages window.
- If the schema is not valid, an error message is displayed in the Messages window (*screenshot below*).

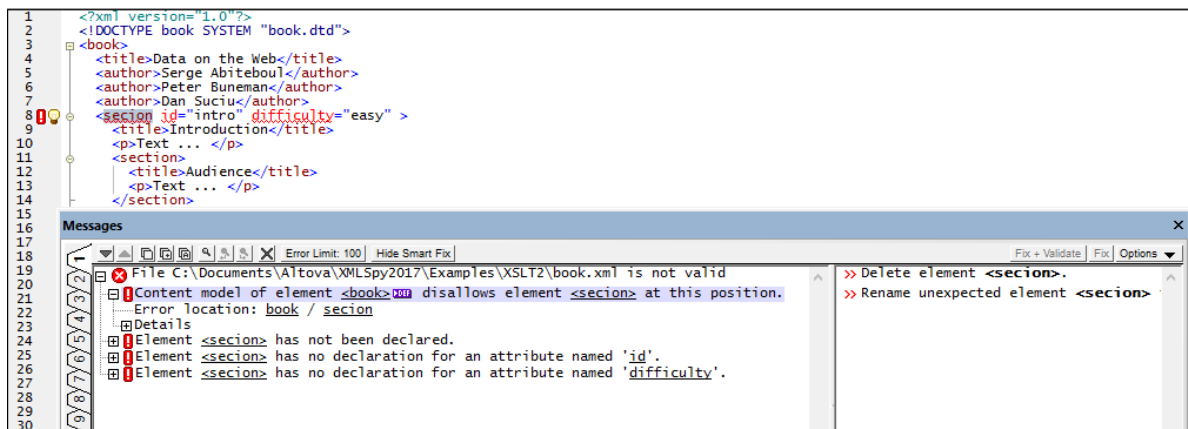

An error message shows each possible cause of that error separately. For example, in the screenshot above, four possible causes of the validation error are reported; the first one is expanded, the other three are collapsed. Each cause is divided into three parts:

1. A description of the possible cause. The description contains links to the relevant definition in the associated schema document. You can quickly go to the specific schema definition to see why exactly the document is invalid.
2. The location path to the node in the XML document that has caused the error. Clicking any node in this location path highlights that node in the document.
3. Detailed information about the error, as well as a link to the relevant paragraph in the schema specification. This is where the schema rules that specify the relevant legality are specified.

Note: If the validation is done in Text View, then clicking a link in the Messages window will *highlight* the corresponding definition in Text View. If the validation is done in Schema View, then clicking a definition link will *open* the definition in Schema View and allow you to *edit the component directly*.

Catalogs

For information about catalog support in XMLSpy, see the section [Catalogs in XMLSpy](#)³³¹.

Automating validation with RaptorXML 2024

RaptorXML is Altova's standalone application for XML validation, XSLT transformation, and XQuery transformation. It can be used from the command line, via a COM interface, in Java programs, and in .NET applications. Validation tasks can therefore be automated with the use of RaptorXML. For example, you can create a batch file that calls RaptorXML to perform validation on a set of documents and sends the output to a text file. See the [RaptorXML documentation](#) for details.

25.4.13 Validate XML on Server (high-performance)



Ctrl+F8

The **XML | Validate on Server (high-performance) (Ctrl+F8)** command validates the active XML document by using the [currently active RaptorXML Server](#)¹⁰²² and its [active configuration](#)¹⁰²². The command immediately carries out the validation and displays the results in the Messages window.

Note: The actual performance depends on the number of PC processor cores used by RaptorXML Server for the validation: The higher the number of cores used, the faster will be the processing.

If you have defined multiple configurations on multiple servers, you can select a server and one of its configurations as the active configuration. The active configuration will be used for subsequent validations. On placing the cursor over the **Tools | Raptor Servers and Configurations** command (see screenshot below), a submenu appears that contains all the added servers, together with the configuration of each. Select the server configuration you want to make the active configuration. In the screenshot below, the `xbrl` configuration of the server named `Raptor-01` has been selected as the active configuration (indicated by the green arrow).

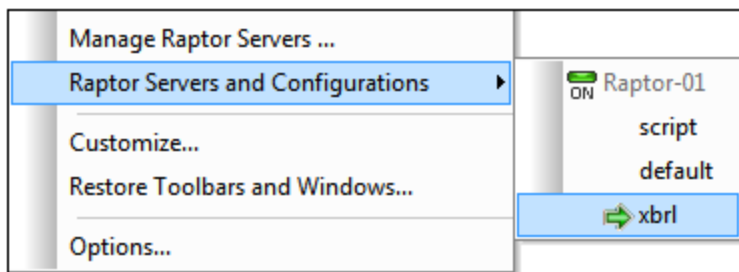

The **Validate XML on Server (high-performance) (Ctrl+F8)** command is also available in the Project entry helper. Right-click the project, a folder, or a file, and select **Validate XML on Server** to validate XML or XBRL data in the selected object.

Note: Raptor validation is available in Text View, Grid View, and XBRL View.

25.4.14 Validating WSDL Files

A WSDL document is not only a WSDL document but also an XML document. As a result, it can be validated as XML and also as WSDL. The following list contains important information about [WSDL validation](#)⁸⁵⁷ behavior in the *Enterprise* and *Professional Editions* of XMLSpy.

- The *Professional Edition* performs simple schema validation, that is, it treats the WSDL file as an XML file and validates it according to the schema defined at <http://schemas.xmlsoap.org/wsdl/>.
- The *Enterprise Edition* provides WSDL validation that goes beyond the XML validation provided by the *Professional Edition*. It does not validate against <http://schemas.xmlsoap.org/wsdl/>. Instead, it uses the document http://www.altova.com/specs_wsdl.html#_document-s as well as its own logic. This provides additional validation information in the context of WSDL. Thus it can happen that a WSDL file is valid in the *Professional Edition*, but not valid in the *Enterprise Edition* (see example below).
- There is a difference between <http://schemas.xmlsoap.org/wsdl/> and http://www.altova.com/specs_wsdl.html#_document-s. The former schema does not contain definitions of **extensibility elements**, which are defined in the WSDL specification. It appears that this shortcoming is an error in the official W3C schema; the shortcoming is addressed in the latter schema (used by *Enterprise Edition*).
- Since *Professional Edition* uses <http://schemas.xmlsoap.org/wsdl/> for validation, extensibility elements will be reported as invalid in *Professional Edition* but valid in *Enterprise Edition* (which uses http://www.altova.com/specs_wsdl.html#_document-s).
- Since the W3C schema is an official schema provided by the W3C working group, any errors in them are, unfortunately, beyond Altova's control.

Example

The following example is part of a WSDL file. Notice the element `getCityTime` that has been declared in the file. This element is mistakenly referenced as `getCityTimes`. The *Enterprise Edition* checks if elements that are referenced have previously been declared in the file, the *Professional Edition* does not. This file (assuming that the rest of the file is valid) would be found to be valid in the *Professional Edition*, but invalid in the *Enterprise Edition* (assuming that `getCityTimes` is not defined somewhere else in the file).

```
<s:element name="getCityTime">
  <s:complexType>
    <s:sequence>
      <s:element minOccurs="0" maxOccurs="1" name="city" type="s:string"/>
    </s:sequence>
  </s:complexType>
</s:element>
<s:element name="abc">
  <s:complexType>
    <s:sequence>
      <s:element ref="getCityTimes"/>
    </s:sequence>
  </s:complexType>
</s:element>
```

25.4.15 Validate on Edit

The **Validate on Edit** command toggles on/off the *Validate on Edit* mode, which enables validation as you type in [Text View](#)¹³⁰, [JSON Grid View](#)¹⁵⁹, or Authentic View. The mode can also be switched on/off via the command's toolbar button or the *Validation > On Edit* option of the [File section of the Options dialog](#)¹⁰⁴¹.

25.4.16 Update Entry Helpers



The **Update Entry Helpers** command updates the Entry Helper windows by reloading the underlying DTD or Schema. If you have modified the DTD or XML Schema that an open XML document is based upon, you should update Entry Helpers so that the intelligent editing information reflects the changes in the schema.

25.4.17 Namespace Prefix

The **XML | Namespace Prefix** command is available in Grid View and opens a dialog box in which you can set the namespace prefix of the selected element or attribute, and, in the case of elements, of its descendants as well.

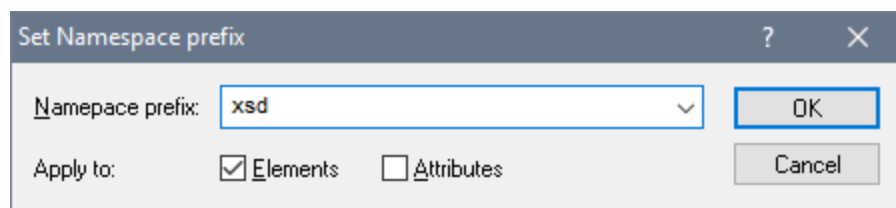

You can choose to set the namespace prefix on either elements, attributes, or both. The namespace prefix is applied to the selected element or attribute, and, if an element is selected, to descendant nodes of the selected element.

25.5 JSON Menu

The **JSON** menu contains commands that are commonly required when working with JSON documents. A majority of the commands are used when working in [JSON Grid View](#)⁵²⁰. If a command is not applicable at the current cursor location, then it is disabled.

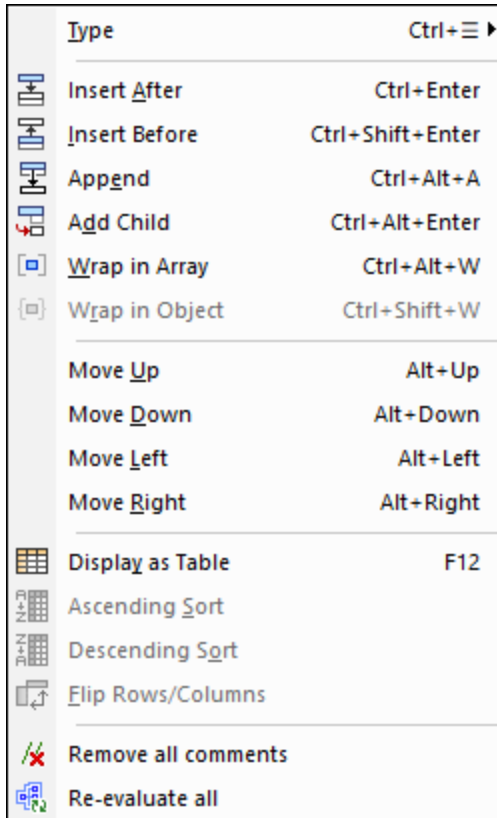

The commands of this menu are described in the sub-sections of this section:

- [Type](#)⁸⁶⁵
- [Insert After&Before, Append, Add Child](#)⁸⁶⁵
- [Wrap in Array/Object](#)⁸⁶⁵
- [Move](#)⁸⁶⁶
- [Display as Table](#)⁸⁶⁶
- [Ascending/Descending Sort](#)⁸⁶⁶
- [Flip Rows/Columns](#)⁸⁶⁶
- [Remove Comments, Re-evaluate All](#)⁸⁶⁷

25.5.1 Type

The **Type** (**Ctrl + Menu key**) command displays a menu containing JSON datatypes (*screenshot below*). Select one type from the menu to assign it to the currently selected cell/s in Grid View. (The **Menu** key is usually located at the bottom-right of the keyboard, next to the **Ctrl** key. Its icon is something like this: ).

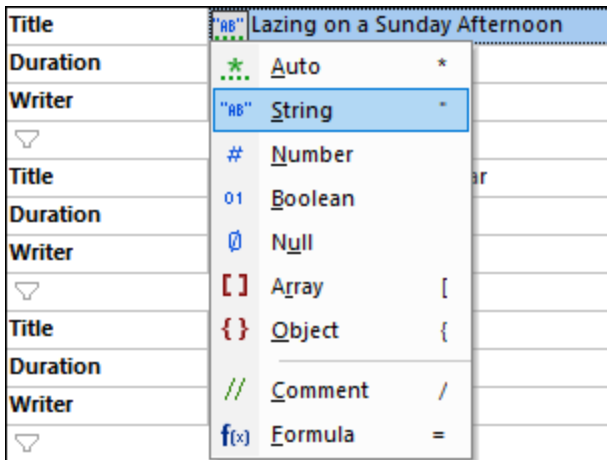

For more information on editing types, see [Editing JSON Document Content](#)¹⁵⁶.

25.5.2 Insert After/Before, Append, Add Child

The **Insert After**, **Insert Before**, **Append**, and **Add Child** commands are enabled when the current selection in Grid View allows a component to be, respectively, inserted, appended, or added as a child.

- **Insert After** inserts a component of the same type as the selected component in a grid row below the selected component.
- **Insert Before** inserts a component of the same type as the selected component in a grid row above the selected component.
- **Append** appends a component of the same type as the selected component in a grid row after all the siblings of the selected component.
- **Add Child** adds a new child component as a last child. The type will be the same as that of the child that was previously last.

For more information about editing JSON document structure, see [Editing JSON Document Structure](#)¹⁵⁵.

25.5.3 Wrap in Array/Object

The **Wrap in Array** and **Wrap in Object** commands each wrap the selected component/s in an array or object, respectively. For more information about editing JSON document structure, see [Editing JSON Document Structure](#)¹⁵⁵.

25.5.4 Move

If it is possible to move a component up, down, left or right from its current location in the grid, then the corresponding command/s are enabled. Select the respective command to carry out the move.

25.5.5 Display as Table

The **Display as Table** command is enabled when a repeating component in Grid View is selected. It is a toggle command that switches the display of the repeating components between standard [Grid View](#)¹⁴⁶ and [Table Display](#)¹⁶⁷. Table Display enables you to view repeated elements as a table in which the rows represent the occurrences while the columns represent child nodes.

See the topic [Table Display \(JSON\)](#)¹⁶⁷ for more information.

25.5.6 Ascending/Descending Sort

The **Ascending Sort** and **Descending Sort** commands are enabled in [Table Display](#)¹⁶⁷ when a column in the table display of a component is selected. To select a column select its header. The sorting is based on the values in the column.

See the topic [Table Display \(JSON\)](#)¹⁶⁷ for more information.

25.5.7 Flip Rows/Columns

The **Flip Rows/Columns** command is enabled in [Table Display](#)¹⁶⁷ when the top left cell of a table is selected (*marked in red in screenshot below*). The command switches rows to columns and vice versa.

| Label | "AB" EMI, Parlophone / Elektra, Hollywood | | |
|--------|---|------------|----------------------|
| Tracks |  | | |
| | Title | Duration | Writer |
| { } 1 | "AB" Tie Your Mother Down | "AB" 04:48 | "AB" Brian May |
| { } 2 | "AB" You Take My Breath Away | "AB" 05:09 | "AB" Freddie Mercury |
| { } 3 | "AB" Long Away | "AB" 03:34 | "AB" Brian May |
| { } 4 | "AB" The Millionaire Waltz | "AB" 04:54 | "AB" Freddie Mercury |
| { } 5 | "AB" You and I | "AB" 03:25 | "AB" John Deacon |
| { } 6 | "AB" Somebody to Love | "AB" 04:56 | "AB" Freddie Mercury |
| { } 7 | "AB" White Man | "AB" 04:59 | "AB" Brian May |
| { } 8 | "AB" Good Old-Fashioned Lover Boy | "AB" 02:54 | "AB" Freddie Mercury |
| { } 9 | "AB" Drowse | "AB" 03:45 | "AB" Roger Taylor |
| { } 10 | "AB" Teo Torriatte (Let Us Cling Together) | "AB" 05:50 | "AB" Brian May |

See the topic [Table Display \(JSON\)](#)¹⁶⁷ for more information.

25.5.8 Remove Comments, Re-evaluate All

The **Remove Comments** command removes all comments. The command can be used in JSON Grid View.

The **Re-evaluate All** command re-evaluates all [filters](#)¹⁸⁴ and [formulas](#)¹⁸⁰. This is useful when the JSON document accesses dynamic data which can change with time (for example, exchange rates). The command can be used in Text View and JSON Grid View.

25.6 DTD/Schema Menu

The **DTD/Schema** menu (*screenshot below*) contains commands to work with DTDs and XML Schemas.

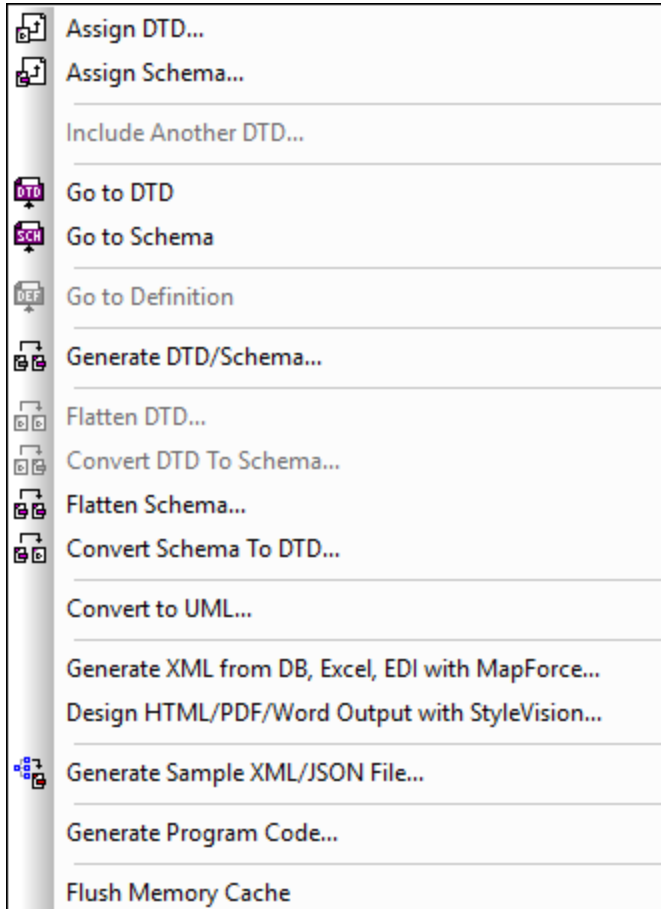

25.6.1 Assign DTD



The **Assign DTD** command is enabled when an XML file is active. It assigns a DTD to an XML document, thus allowing the document to be validated and enabling intelligent editing for the document. The command opens the Choose Schema or DTD dialog (*screenshot below*) via which you can select the DTD you want to assign.

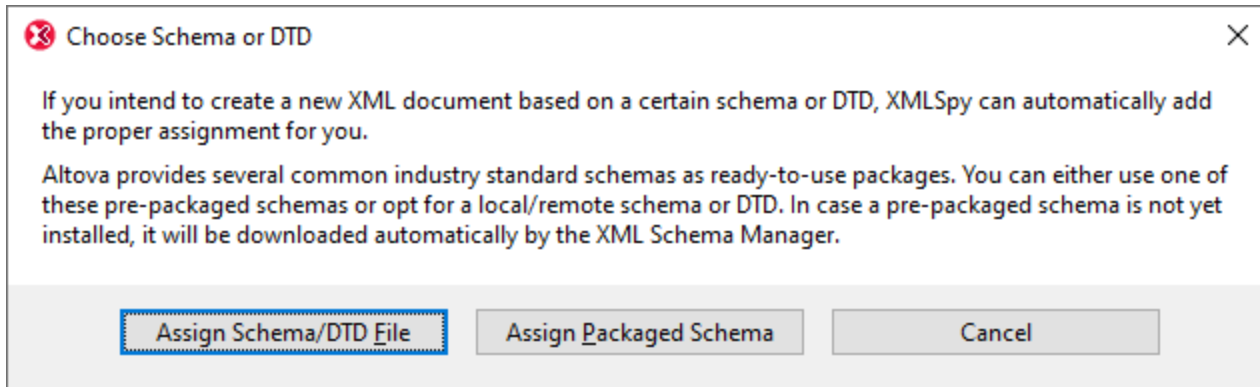

The following options are available:

- *Assign Schema/DTD File*: Browse for the XML Schema or DTD file you want to assign. Note that you can make the assignment in the document a relative or absolute path.
- *Assign Packaged Schema*: Some schemas are each actually a package of schema files rather than a single schema file. The *Assign Packaged Schema* option opens a dialog that lists the schema packages supported by Altova's [Schema Manager](#)³⁰⁷. In this dialog, schemas listed in black have already been installed on your machine, those in blue have not been installed and can be installed by [Schema Manager](#)³⁰⁷. When you select a schema package or one of its schema entry points and click **OK**, the following happens: The schema package will be installed if it has not already been installed. The selected schema package (previously installed or newly installed) will be assigned to the document and will be used from this point onwards for document validation.
- *Cancel*: If a new file is being created, then it is created with no XML Schema or DTD assignment. If the schema assignment is for an already existing document, then the dialog is exited.

When you are done, your XML document will contain a DOCTYPE declaration that references the assigned DTD. The DOCTYPE declaration will look something like this:

```
<!DOCTYPE main SYSTEM "http://link.xmlspy.com/spyweb.dtd">
```

Note: A DTD [can be assigned to a new XML file](#)⁷⁸² at the time the file is created.

25.6.2 Assign Schema



The **Assign Schema** command is enabled when an XML document is active. It assigns an XML Schema to an XML document, thus allowing the document to be validated and enabling intelligent editing for the document. The command opens the Choose Schema or DTD dialog (*screenshot below*) via which you can select the XML Schema or XML schema package you want to assign.

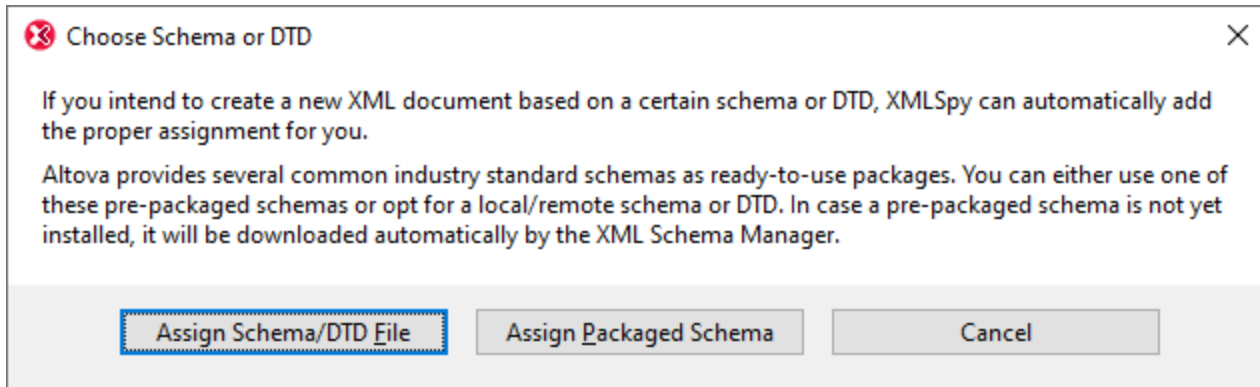

The following options are available:

- *Assign Schema/DTD File*: Browse for the XML Schema or DTD file you want to assign. Note that you can make the assignment in the document a relative or absolute path.
- *Assign Packaged Schema*: Some schemas are each actually a package of schema files rather than a single schema file. The *Assign Packaged Schema* option opens a dialog that lists the schema packages supported by Altova's [Schema Manager](#)³⁰⁷. In this dialog, schemas listed in black have already been installed on your machine, those in blue have not been installed and can be installed by [Schema Manager](#)³⁰⁷. When you select a schema package or one of its schema entry points and click **OK**, the following happens: The schema package will be installed if it has not already been installed. The selected schema package (previously installed or newly installed) will be assigned to the document and will be used from this point onwards for document validation.
- *Cancel*: If a new file is being created, then it is created with no XML Schema or DTD assignment. If the schema assignment is for an already existing document, then the dialog is exited.

When you are done, your XML document will contain an XML Schema assignment together with the required namespaces. The schema assignment will look something like this:

```
xmlns="http://www.xmlspy.com/schemas/icon/orgchart"
xmlns:xsi="http://www.w3.org/1999/XMLSchema-instance"
xsi:schemaLocation="http://www.xmlspy.com/schemas/icon/orgchart
http://schema.xmlspy.com/schemas/icon/orgchart.xsd"
```

25.6.3 Include Another DTD

The **DTD/Schema | Include** another DTD command allows you to include another Document Type Definition (DTD) or external parsed entity into the internal subset of a document type definition, or in any DTD document. This is done by defining a corresponding external parsed entity declaration and using that entity in the following line:

```
<!ENTITY % navigation.dtd SYSTEM "S:\xml\navigation.dtd">
%navigation.dtd;
```

The command opens the Assign File dialog to let you specify the DTD file you want to include in your DTD.

Note: This command is enabled in Grid View only.

25.6.4 Go to DTD



The **DTD/Schema | Go to DTD** command opens the DTD on which the active XML document is based. If no DTD is assigned, then an error message is displayed.

25.6.5 Go to Schema



The **DTD/Schema | Go to Schema** command opens the XML Schema on which the active XML document is based. If no XML Schema is assigned, then an error message is displayed.

25.6.6 Go to Definition



The **DTD/Schema | Go to Definition** command displays the exact definition of an element or attribute in the corresponding Document Type Definition or Schema document.

To see the item definition in Grid View

1. Click left on the item.
2. Select the menu item **DTD/Schema | Go to Definition**, or click on the icon.

To see the item definition in Schema View

- Use CTRL + Double click on the item you want to see the definition of, or
- Click the item and select menu option **DTD/Schema | Go to Definition**, or click on the icon.

In both cases, the corresponding DTD or Schema file is opened, and the item definition is highlighted.

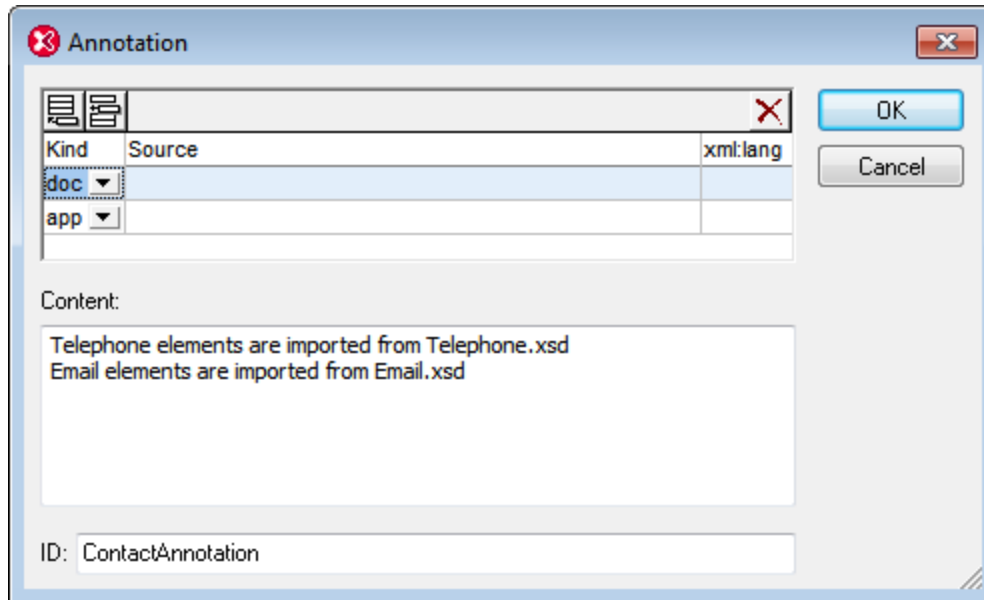

25.6.7 Generate DTD/Schema



The **DTD/Schema | Generate DTD/Schema** command generates a new DTD or W3C XML Schema from an XML document (or from a set of XML documents contained in a folder in the project window). This command is useful when you want to generate a DTD or XML Schema from XML documents.

Generate DTD/Schema

DTD/Schema file format

- DTD
- W3C Schema

Generate one shared type for all equal named elements

Validate and resolve entities

Define types used for elements

- Local (if applicable)
- Global

Define simple types used for attributes

- Global, merge equal types into one
- As distinct global types
- Local

Define attributes with same name and type

- Local
- Global

Simple type recognition

- Best possible
- Numbers only
- No detection

Create enumerations

- For all types of values
- For plain strings only
- Always
- For a maximum distinct values

Ignore values longer than characters for enumerations

OK Cancel

If you generate an XML Schema, the following options are available:

- **Elements:** The type of elements can be defined locally or globally (*Define types for elements*). If elements have the same name, a common type can be declared for use in the definition of these elements (*Generate one shared type*).
- **Attributes:** The simple types of attributes (*Define simple types for attributes*) can be defined as (i) common global types; (ii) distinct global types; (iii) local types. Attributes with the same name and type can be defined either locally or globally.
- **Simple type recognition:** The recognition of types (*Simple type recognition*) can be set to: (i) best possible; (ii) recognition of number datatypes only; (iii) no datatype recognition, in which case all datatypes are set to `xs:string`.
- **Entity resolution:** In the XML document, entities may appear in element content and attribute values. Whether they are resolved or not (*Validate and resolve entities*) is therefore significant for enumeration values. Furthermore, some entities (especially parsed entities that contain markup) can affect the content model differently depending on whether they are resolved or not. Note that the XML document will be validated for being correct XML before the schema is generated. If the document is invalid, the schema generation process will be discontinued.
- **Enumerations:** All types of values, or string values only, can be enumerated.

If you generate a DTD, the entity resolution and enumeration options are available.

The Generate DTD/Schema command normally operates on the active main window, but you can also use the **Generate DTD/Schema** command on any file, folder, or group of files in the active project window.

If elements or attributes in more than one namespace are present, XMLSpy generates a separate XML Schema for each distinct namespace; therefore, multiple files may be created on the disk.

25.6.8 Flatten DTD

The **Flatten DTD** command is enabled when a DTD is the active document. It creates a new flat DTD, removing parameter entities and producing a single DTD from a collection of modules. It also suppresses sections marked `IGNORE` and deletes unused parameter entities.

The command pops up a Save dialog, in which you select a location at which to save the generated DTD file. Click **Save** to carry out the conversion. The flattened DTD file is generated and opened in XMLSpy.

25.6.9 Convert DTD to Schema

The **Convert DTD to Schema** command is enabled when a DTD is the active document. It converts a DTD into an XML Schema document (XSD).

The command pops up the Convert DTD to W3C Schema dialog (*screenshot below*), in which you can select whether complex elements should be converted into elements or complex types. On clicking **OK**, you are prompted to select a location at which to save the generated XSD file. Click **Save** to carry out the conversion. The XSD file is generated and opened in XMLSpy.

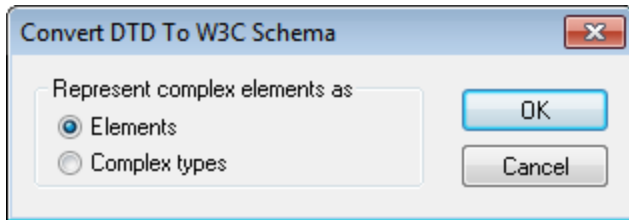

When you convert a DTD to XML Schema, XMLSpy makes a few assumptions because of the limited information available. Most notably, the values of certain DTD components are treated literally rather than having their semantics parsed. This is because the program cannot know which of several possible usages is intended. In these cases, you should modify the generated conversion.

In any case, you should carefully examine the generated conversion to see if you can enhance it. A few areas in which improvements may be required are listed below.

Attribute Datotyping

DTDs allow for only 10 attribute datatypes, whereas XML Schemas, for instance, allow for more than 40 datatypes plus derived datatypes. You may wish to enhance a generated XML Schema, for example, by using a more restrictive datatype. Note that when an [XML Schema is converted to DTD](#)⁸⁷⁷ datatype information will be lost.

Namespaces

DTDs are not namespace-aware. As a result, if namespaces are to be specified in a DTD they must be hard-coded into element and attribute names. This could pose challenging problems when converting from one schema to another.

Entities

XML Schema does not have equivalents for the general entity declarations of DTDs. When XMLSpy converts a DTD to an XML Schema, it ignores entity declarations.

Unparsed data declarations

DTDs and XML Schemas use different mechanisms for handling unparsed data. This is explained in more detail below.

DTDs use the following mechanism:

- A notation is declared consisting of a name and an identifier, for example:
`<!NOTATION gif SYSTEM "image/gif">`
- You declare the entity, for example:
`<!ENTITY cover_img SYSTEM "graphics/cover_img.gif" NDATA gif>`
- Typically, you specify an attribute type of ENTITY on the relevant attribute, for example:
`<!ELEMENT img EMPTY>`
`<!ATTLIST img format ENTITY #REQUIRED>`

In XML Schema, the corresponding mechanism is as follows:

- Declare a notation. This functions in the same way as for the DTD.

```
<xs:notation name="gif" public="image/gif"/>
```

Note that the `public` attribute is mandatory and holds the identifier. An optional `system` attribute holds the system identifier and is usually an executable that can deal with resources of the notation type.

- You associate the `notation` declaration with a given attribute value using the `NOTATION` datatype. You cannot, however, use the `NOTATION` datatype directly, but must derive another datatype from the `NOTATION` datatype.

```
<xs:simpleType name="formatType">
  <xs:restriction base="xs:NOTATION">
    <xs:enumeration value="gif"/>
    <xs:enumeration value="jpeg"/>
  </xs:restriction>
</xs:simpleType>
```

- You associate the attribute with the datatype derived from the `NOTATION` datatype, e.g.

```
<xs:complexType name="imgType">
  <xs:attribute name="height"/>
  <xs:attribute name="width"/>
  <xs:attribute name="location"/>
  <xs:attribute name="format" type="formatType" use="required"/>
</xs:complexType>
<xs:element name="img" type="imgType"/>
```

When you convert a DTD to an XML Schema, XMLSpy does the following:

- Something like

```
<!ATTLIST image format ENTITY #REQUIRED
...>
```

is converted to

```
<xs:attribute name="format" type="xs:ENTITY" use="required"/>
```

- And something like

```
<!NOTATION gif SYSTEM "image/gif">
```

is converted to

```
<xs:notation name="gif" system="image/gif"/>
```

You should therefore make the following modifications:

1. In notations like `<xs:notation name="gif" system="image/gif"/>` replace `system` with `public`, and add an optional `system` identifier if required.
2. Derive a datatype from the `NOTATION` datatype as described above for `formatType`.
3. Associate the derived datatype with the relevant attribute.

Note: According to the XML Schema specification, you do not need to—or cannot, depending on your viewpoint—declare an external entity.

25.6.10 Flatten Schema

The **Flatten Schema** command is enabled when an XML Schema is the active document. It generates a new flat XSD by (i) adding the components of all included schemas as global components of the active schema, and (ii) deleting the included schemas.

The command redirects to the [Flatten Schema](#)⁹⁰⁴ command of the Schema Design menu. Since the [Flatten Schema](#)⁹⁰⁴ command is available in Schema View only, you will be prompted about whether you wish to switch to Schema View or not. For more information, see the [Flatten Schema](#)⁹⁰⁴ command.

25.6.11 Convert Schema to DTD

The **Convert Schema to DTD** command is enabled when an XML Schema is the active document. It converts an XML Schema document (XSD) into a DTD.

The command pops up a Save dialog, in which you select a location at which to save the generated DTD file. Click **Save** to carry out the conversion. The DTD file is generated and opened in XMLSpy.

Note the following points:

1. When you convert an XML Schema to a DTD, the namespace prefixes used in the XML Schema—not the namespace URIs or the namespace declarations—are carried through to the names of the corresponding elements and attributes in the DTD.
2. Since XML parsers ignore namespaces when validating an XML document against a DTD, the namespace declarations themselves are not converted.
3. The `elementFormDefault` and `attributeFormDefault` attributes of the `xs:schema` element determine what elements and attributes have their prefixes included in the conversion process. If set to unqualified, then only globally declared elements and attributes, respectively, include prefixes in the conversion. If set to qualified, all element and attribute names have their prefixes included in the conversion.
4. Prefixes are converted to their corresponding string value plus a colon. Elements and attributes in default namespaces are converted to elements and attributes with names that begin with the string: `default_NS_X`, where `X` is an integer (starting with 1 and having a maximum value equal to the number of default namespaces used in the XML Schema).
5. In the DTD, element names are composed of parameter entities. This enables you to easily change the prefix in the DTD should the prefix in the XML document ever need to change. Parameter entity definitions can be changed either in the DTD document itself or by overriding the parameter entity definitions in the XML document's internal DTD subset.

Note: Namespaces have no semantic value in DTDs, and namespace prefixes carried over from the XML Schema become merely a lexical part of the name of the element or attribute defined in the DTD.

25.6.12 Convert to UML

The **DTD/Schema | Convert to UML** command converts a W3C XML Schema to an Altova UModel Project (.ump) document (hereafter UModel project). UMP is the native format of Altova UModel, Altova's UML modeling application. UMP files can then be viewed and edited in Altova UModel.

To convert a schema to UML, do the following:

1. With the schema open, click the **Convert to UML** command. This pops up the Convert to UML dialog (*screenshot below*).

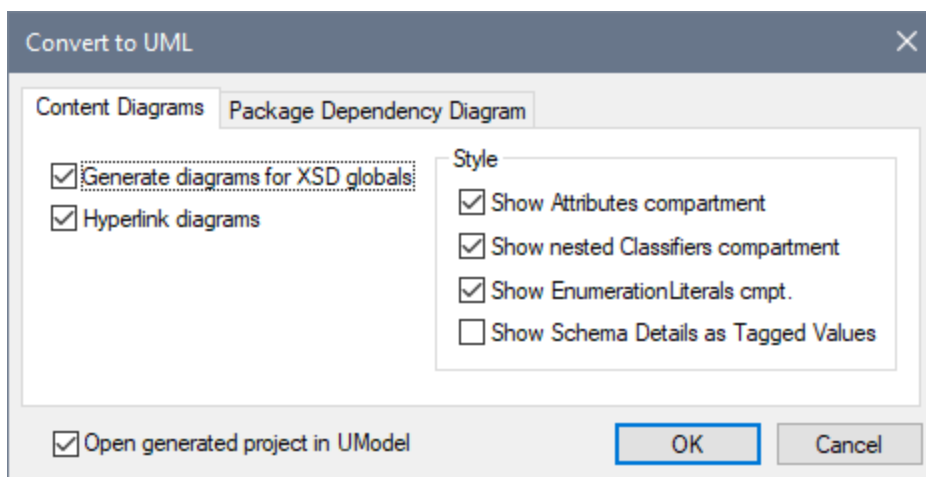

2. In the Content Diagrams tab, select the option Generate Diagrams for XSD Globals. This will generate, in the UModel project, a content model diagram for each global component.
3. Select the required options from those available in the dialog. These options are explained below.
4. If you wish to view the created project in UModel immediately, select the option to open the project in UModel. Otherwise leave this option unselected.
5. Click **OK**.
6. In the Save As dialog that appears, browse for the destination folder, then enter the name of the UMP file, and click **Save**.

Convert to UML options

The following options are available in the Convert to UML dialog.

In the **Content Diagrams** tab:

- *Hyperlink diagrams* creates in each diagram a link to the entry of that global component in the Model Tree view, thus enabling the component to be quickly located in the schema hierarchy.
- In the *Style* pane, the show compartments options enables various compartments to be either shown or hidden.

In the **Package Dependency Diagram** tab:

- The *Generate Diagram* option determines whether a package dependency diagram is generated. A package dependency diagram provides an overview of the entire package, showing the relationships of

package components to one another. Note that the other options in this tab will be enabled only if the Generate Diagram option is selected.

- Selecting the *Hyperlink Package to Diagram* option creates a link from the package diagram to the Model Tree View.
- Four options are available for the layout of the package dependencies diagram: (i) unorganized layout (Autolayout option unselected); (ii) hierarchical layout (Autolayout and Hierarchical options selected); (iii) block (Autolayout and Block options selected); and (iv) evenly spaced (Autolayout and Force Directed options selected). The layout can be modified by editing the diagram in UModel.

Note: The Convert to UML feature supports W3C XML Schemas only.

25.6.13 Generate XML from DB, Excel, EDI with MapForce

The **DTD/Schema | Generate XML from DB, Excel, EDI with MapForce** command launches Altova's MapForce if the application is installed. MapForce enables you to map a schema to another DTD, XML Schema, or database and to generate XML.

25.6.14 Design HTML/PDF/Word Output with StyleVision...

The **DTD/Schema | Design HTML/PDF Output in StyleVision...** command launches Altova's StyleVision if the application is installed. StyleVision enables you to design stylesheets for HTML, PDF, and RTF output.

25.6.15 Generate Sample XML/JSON File

The **Generate Sample XML/JSON File** command is enabled in Text View, Grid View, and Schema View, and generates an XML, JSON instance, or YAML document based on the currently active schema file:

- If the currently active file is a DTD or XML Schema, then an XML instance file can be generated from it.
- If the currently active file is a JSON schema, then a JSON instance document or a YAML document can be generated from it.

The generated file is opened in a new window in XMLSpy, from where you can save it to file. The setting for generating (i) XML files and (ii) JSON and YAML files are described below.

Generating sample XML files

With a DTD or XML Schema active, you can generate a sample XML instance based on the schema. On clicking the **Generate Sample XML/JSON File** command, the Generate Sample XML File dialog (*screenshot below*) appears, in which you can specify the options for the sample generation.

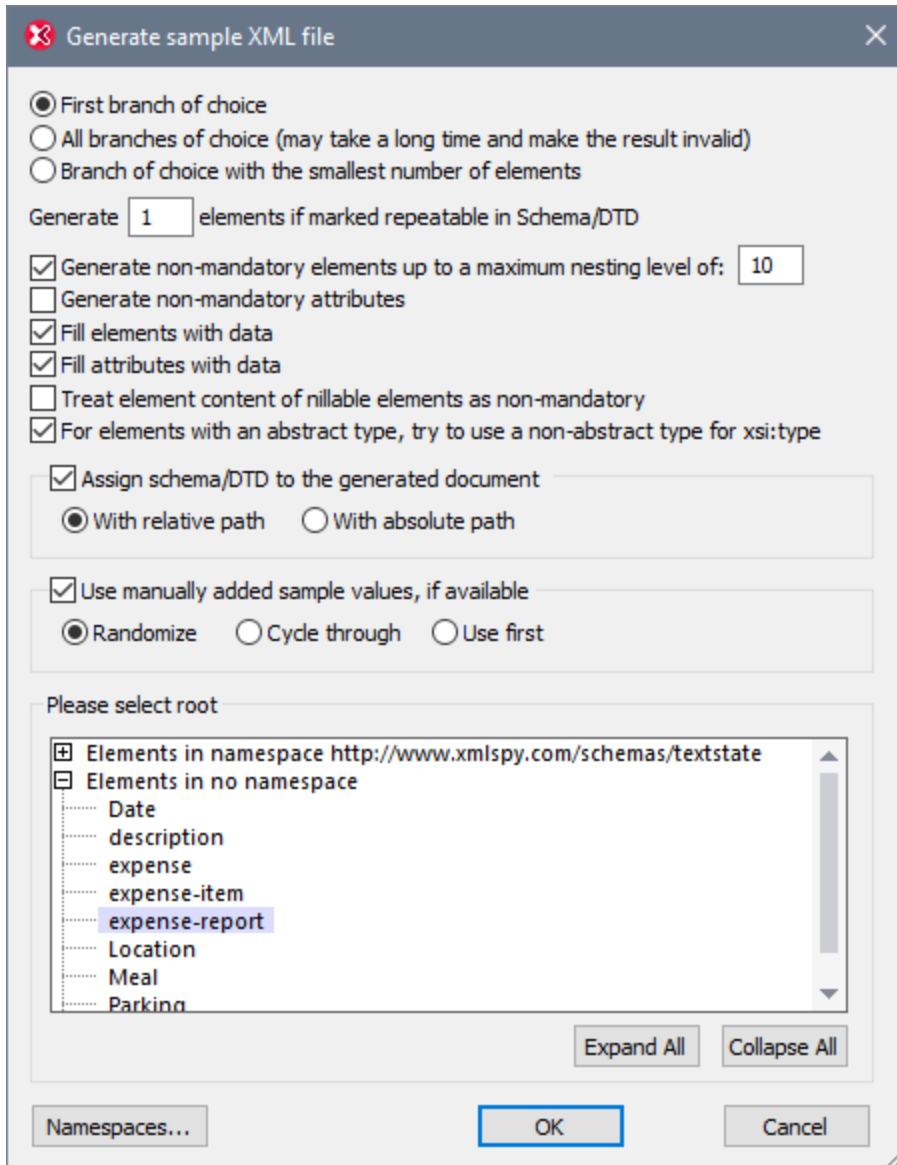

Elements of choice groups

A choice group is a group of elements from which one may be used. For example, if an element called `items` is defined as having a `choice` group consisting of the three elements: `cd`, `dvd`, `book`, then `items` can validly have any one of these three elements as a child element (with a maximum number of occurrences as specified in that element's `maxOccurs` attribute).

In the Generate Sample XML File dialog, you can select whether (i) the first branch (element) of the `choice` group, (ii) all branches, or (iii) the branch with the smallest number of descendant elements is generated. Note that the *All branches* selection could generate an invalid document since only one branch from a `choice` group is allowed.

If any of the `choice` groups's branches are repeatable (that is, it has a `maxOccurs` value of greater than 1), then you specify, in the first text box of the dialog, how many of the repeatable elements to generate, up to a maximum of 99. If the `maxOccurs` attribute of the `choice` group is defined as `unbounded` or as a large number

and *All branches* is selected in the Generate Sample XML File dialog, then the `maxOccurs` of the `choice` group is also limited by the number of repeatable elements you specify in the first text box of the dialog.

Generate non-mandatory elements

Activating this option generates both the mandatory and non-mandatory elements defined in the schema. If activated, you can specify the level of nesting that you want. A greater nesting depth enables non-mandatory elements to be generated up to the nesting level you specify.

Generate non-mandatory attributes

Activating this option generates both the mandatory and non-mandatory attributes defined in the schema.

Generate X elements if marked repeatable in Schema/DTD

Activating this option generates the number of repeatable elements you enter in the text box. This applies to all elements, including those in `choice` groups.

Fill elements and attributes with data

Activating this option inserts the datatype values of the respective elements and attributes. For example if an element is defined as being of datatype `string`, then the element is given a dummy value of `string`.

Nillable elements and abstract types

The contents of nillable elements can be treated as non-mandatory, and elements with an abstract type can use a non-abstract type for its `xsi:type` attribute.

Schema assignment for the generated XML file

The schema used to generate the XML file can be assigned to the generated XML file with a relative or absolute path.

Use manually added sample values if available

If the schema component has sample values assigned to it, then these will be used as the value or content of that component. For individual components, sample values are assigned in the [Facets Entry Helper](#)²⁵⁸, in the Samples tab. Which value from the available sample values is selected for a single file generation can be specified:

- A random selection.
- Each sample value in turn for each instance of the component. For each file generation, the cycle starts anew.
- The first value always.

Root element

If the schema contains more than one global element, these are listed, and the root element required for the sample XML file can be selected from the list.

Namespaces

Click the **Namespaces** button to open the Edit Namespaces dialog (*screenshot below*). The namespaces that are defined in the schema, plus any standard XML Schema namespaces that are required in the sample XML file, will appear in this dialog.

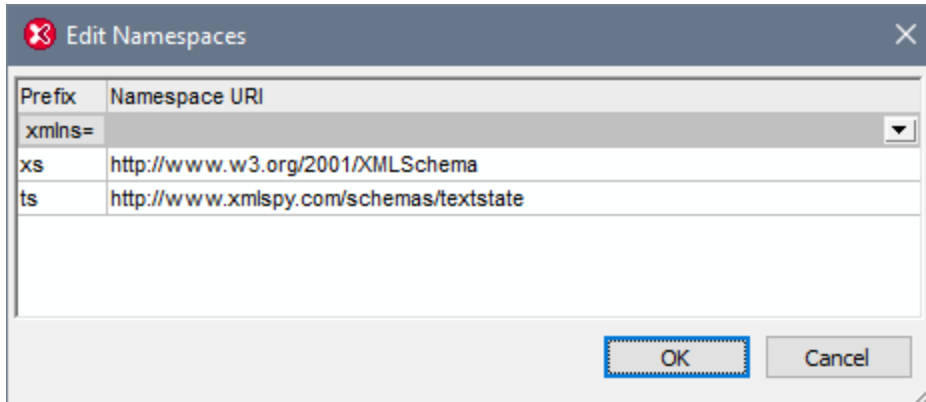

You can edit the following:

- The namespace prefix that is bound to any of the document's namespaces. The namespace prefixes that are set in this dialog will be used (in the generated XML file) to prefix nodes that are in the corresponding namespace. For example, the screenshot indicates that nodes in the `http://www.xmlspy.com/schemas/textstate` namespace will be prefixed with `ts:` in the sample file.
- You can set one of the document's namespaces to be the default namespace (`xmlns=`) by selecting, in the `xmlns=` combo box, the namespace that you want. Nodes in the namespace that is selected as the default namespace will then be generated without a namespace prefix.

Generating sample JSON files

With a JSON schema active, you can generate a sample JSON or YAML instance file that is based on the JSON schema. On clicking the command, the Generate Sample JSON/YAML File dialog (*screenshot below*) appears. Choose the format of the JSON/YAML file to generate and specify the options.

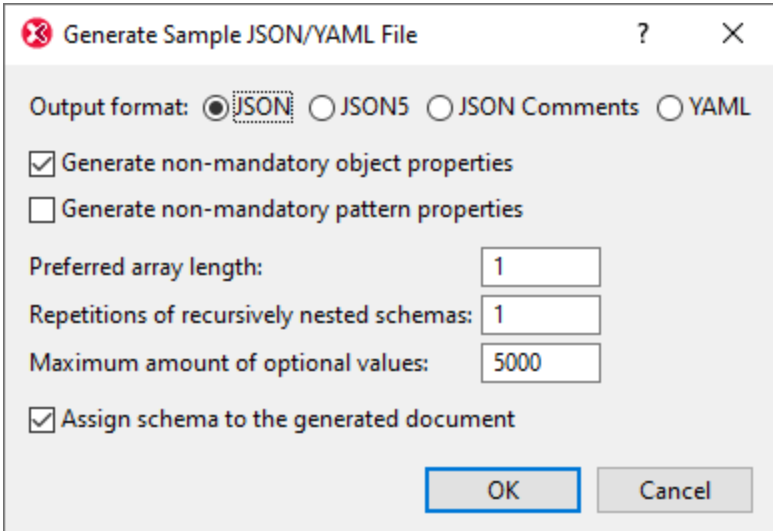

Generate Sample JSON/YAML File

Output format: JSON JSON5 JSON Comments YAML

Generate non-mandatory object properties

Generate non-mandatory pattern properties

Preferred array length:

Repetitions of recursively nested schemas:

Maximum amount of optional values:

Assign schema to the generated document

OK Cancel

You can choose whether to generate [non-mandatory object properties](#)⁵³³, [non-mandatory pattern properties](#)⁵³³, the [length of arrays](#)⁵⁴⁴, the repetitions of recursive definitions, and the maximum number of optional values. You can also specify whether the active JSON schema should be automatically [assigned](#)⁵⁶¹ to the generated JSON or YAML sample file. If the JSON schema is assigned, then it will be added as the validation schema to the JSON tab of the Info window.

25.6.16 Flush Memory Cache

The **DTD/Schema | Flush Memory Cache** command flushes all cached schema (DTD and XML Schema) documents from memory. To speed up validation and intelligent editing, XMLSpy caches recently used schema documents and external parsed entities in memory. Information from these cached documents is also displayed when the [Go to Definition](#)⁸⁷¹ command is invoked.

Flush the memory cache if memory is tight on your system, or if you have used documents based on different schemas recently.

25.7 Schema Design Menu

The **Schema Design** menu enables you to configure the Schema View of XMLSpy. This view enables you to design XML Schemas in a GUI. It is available when an XML Schema document is active in Schema View.

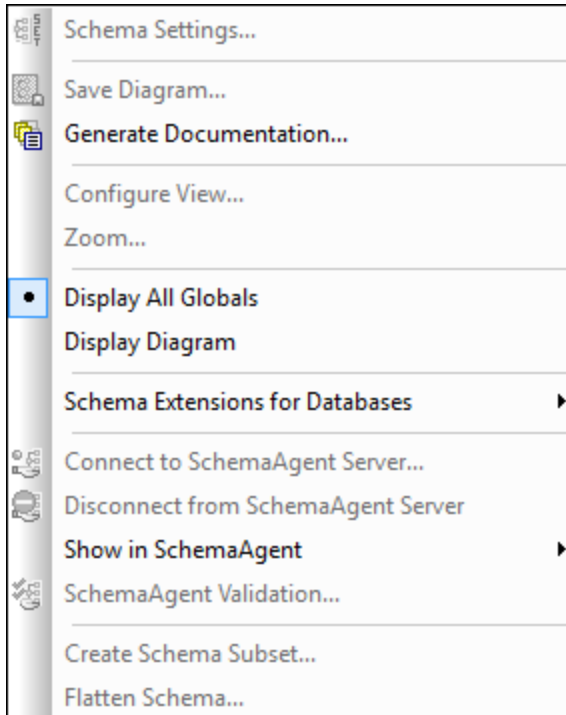

The commands available in this menu are described in this section.

25.7.1 Schema Settings



The **Schema Design | Schema Settings** command is enabled in Schema View and lets you define global settings for the active schema. These settings are the attributes of the `xs:schema` element.

Schema settings

elementFormDefault: qualified unqualified

attributeFormDefault: qualified unqualified

blockDefault:

finalDefault:

defaultAttributes: Contact

xpathDefaultNamespace: ##targetNamespace

version: 1.1

xml:lang: id:

No targetNamespace

targetNamespace:

| Prefix | Namespace |
|--------|---|
| | http://www.altova.com/schemas/org |
| xs | http://www.w3.org/2001/XMLSchema |
| vc | http://www.w3.org/2007/XMLSchema-versioning |

OK Cancel

The settings defined in the Schema Settings dialog above (when XSD mode is set to 1.1) will create the following `xs:schema` element.

```
<xs:schema xmlns="http://www.altova.com/schemas/org"
  xmlns:xs="http://www.w3.org/2001/XMLSchema"
  xmlns:vc="http://www.w3.org/2007/XMLSchema-versioning"
  targetNamespace="http://www.altova.com/schemas/org"
  elementFormDefault="qualified"
  xpathDefaultNamespace="##targetNamespace"
  version="1.1"
  defaultAttributes="Contact"
  vc:minVersion="1.1">
```

Note the following points:

- What's in the Schema Settings dialog will differ according to the active XSD mode. If XSD 1.0 is the active mode, then XSD 1.1 attributes are not present in the dialog.
- In [XSD 1.1 mode](#)⁽²⁰⁰⁾, the attribute `vc:minVersion="1.1"` must be present on the `xs:schema` element.

- The `defaultAttributes` and `xpathDefaultNamespace` attributes are XML Schema 1.1 features and will be available only in [XSD 1.1 mode](#)²⁰⁰. They can be present in XSD 1.1.
- The other attributes are available in both XSD 1.0 and XSD 1.1.

The `version` attribute

The version attribute is the document version. It is not the [XSD version of the document](#)²⁰⁰.

The `defaultAttributes` attribute

The `defaultAttributes` attribute enables you to select an attribute group as the default attribute group of all complex types in the schema.

The default attribute group will be displayed in the content model of these complex types. In the screenshot below, for example, the `group` element has complex content. As a result, the `Contact` attribute group, which was set as the default attribute group of all complex types in the schema (see screenshot above where this has been set), is automatically available on the `group` element. If you want to disable the default attribute group on a particular complex type, then you must set the complex type's `defaultAttributesApply` attribute to `false`. In Schema View, you can do this via the `defAttrs` property in the Details entry helper of the complex type (see screenshot below).

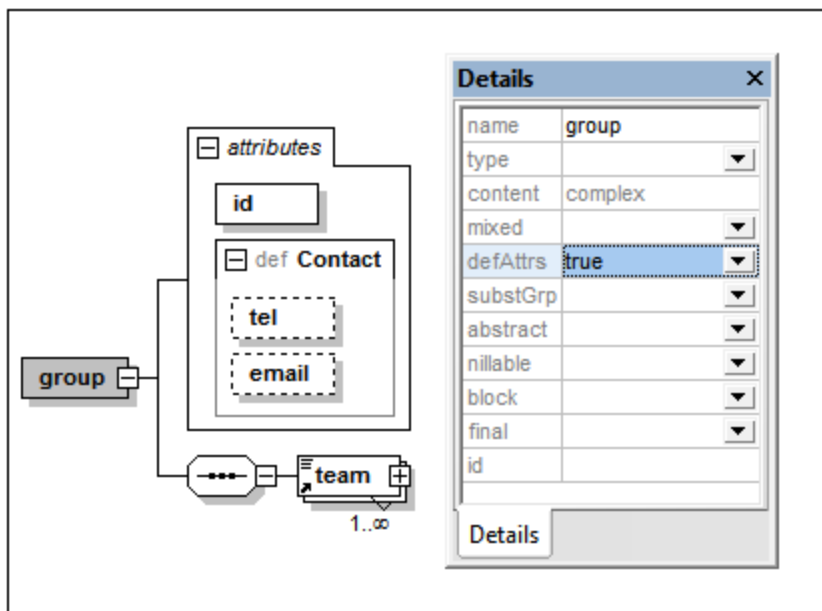

The `xpathDefaultNamespace` attribute

The `xpathDefaultNamespace` attribute sets the default namespace for elements in XPath expressions used in the schema. If set in the Schema Settings dialog, the attribute is applied to the top-level `xs:schema` element. So the scope of the declaration will be the entire document. You can override the declaration on `xs:schema` with declarations on elements where the attribute is allowed:

- `xs:assert` and `xs:assertion`
- `xs:alternative`

- `xs:selector` and `xs:field` (in identity constraints)

You can change the XPath default namespace in the Details entry helper of the elements listed above.

The `xpathDefaultNamespace` attribute can have one of three allowed values:

- `##targetNamespace`: The XPath default namespace will be the same as the target namespace of the schema
- `##defaultNamespace`: The XPath default namespace will be the same as the default namespace of the schema
- `##local`: There is no XPath default namespace

If no XPath default namespace is declared in the document, unprefixed elements in XPath expressions will be in no namespace. The XPath default namespace declaration does not apply to attributes.

25.7.2 Save Diagram



The **Schema Design | Save Diagram** command saves the diagram of the Content Model that is currently displayed in the Main Window (of an XMLSchema or JSON Schema) as an image file in PNG or SVG format to any desired location.

25.7.3 Generate Documentation



The **Schema Design | Generate Documentation** command generates detailed documentation about your XML or JSON schema (see *screenshot below*) in HTML, MS Word, RTF or PDF. The documentation generated by this command can be freely altered and used; permission from Altova to do so is not required. Documentation is generated for components you select in the (JSON) Schema Documentation dialog (which appears when you select the **Generate Documentation** command). Related elements (child elements, complex types, etc.) are typically hyperlinked in the onscreen output, enabling you to navigate from component to component. Components with a content model also have links to the content model definitions. Note that schema documentation is also generated for **included and imported schema components**. The various documentation-generation options for XML Schema are described in the section [Documentation Options](#)⁸⁸⁹. JSON schema documentation options are described in the section [Generating JSON Schema Documentation](#)⁵⁵⁸.

Note that the [Documentation Options](#)⁸⁸⁹ are applied on top of the settings you specify in the [Schema Display Configuration dialog](#)⁸⁹³.

Note: In order to generate documentation in MS Word format, you must have MS Word (version 2000 or later) installed.

You can either use XMLSpy's fixed standard design for the generated document, or you can use a StyleVision SPS for the design. Using a StyleVision SPS enables you to customize the design of the generated documentation as well as to generate PDF as an additional output format. How to work with an SPS is explained in the section, [User-Defined Design](#)⁸⁹¹.

Note: In order to use an SPS to generate schema documentation, you must have StyleVision installed on your machine.

| Schema ipo.xsd | |
|---|---|
| schema location: | C:\Program Files\Altova\XMLSPY2004\Examples\ipo.xsd |
| targetNamespace: | http://www.altova.com/IPO |
| Elements | Complex types |
| comment | Items |
| purchaseOrder | PurchaseOrderType |
| Simple types | Skus |
| schema location: C:\Program Files\Altova\XMLSPY2004\Examples\address.xsd | |
| targetNamespace: http://www.altova.com/IPO | |
| Complex types | Simple types |
| Address | EU-Postcode |
| EU-Address | US-State |
| US-Address | |
| element comment | |
| diagram |  |
| namespace | http://www.altova.com/IPO |
| type | string |
| properties | content simple |
| used by | element Items/item
complexType PurchaseOrderType |
| source | <code><element name="comment" type="string"/></code> |

The screenshot above shows generated schema documentation with an index (all related schemas with their global components organized by component type) at the top of the document.

Note: When generating documentation for W3C schema documents, XMLSpy uses application-internal versions of these documents. Consequently, other locations of these documents are not considered, and redefinitions and other schema modifications will not be reflected in the documentation.

25.7.3.1 Documentation Options

The **Schema Design | Generate Documentation** command generates detailed documentation of the active schema: XML Schema or JSON schema. This section describes the generation of XML Schema documentation. The procedure for generating JSON schema documentation is similar. For details about generating JSON schema documentation and a description of documentation generation settings, see the section [Generating JSON Schema Documentation](#)⁵⁵⁸.

Generating XML Schema documentation

If an XML Schema document is active and you click the **Generate Documentation** command, the Schema Documentation dialog (*screenshot below*) is displayed. In this dialog, you can select options for the documentation.

In the Documentation Design pane of the dialog you can select whether to use the fixed XMLSpy design for the generated documentation or whether to use a customized design created in a StyleVision SPS. Select the option you want. Note that PDF output is available only for documentation generated with a StyleVision SPS, not for documentation generated using a fixed design. How to work with a user-defined design is described in the section, [User-Defined Design](#)⁸⁹¹.

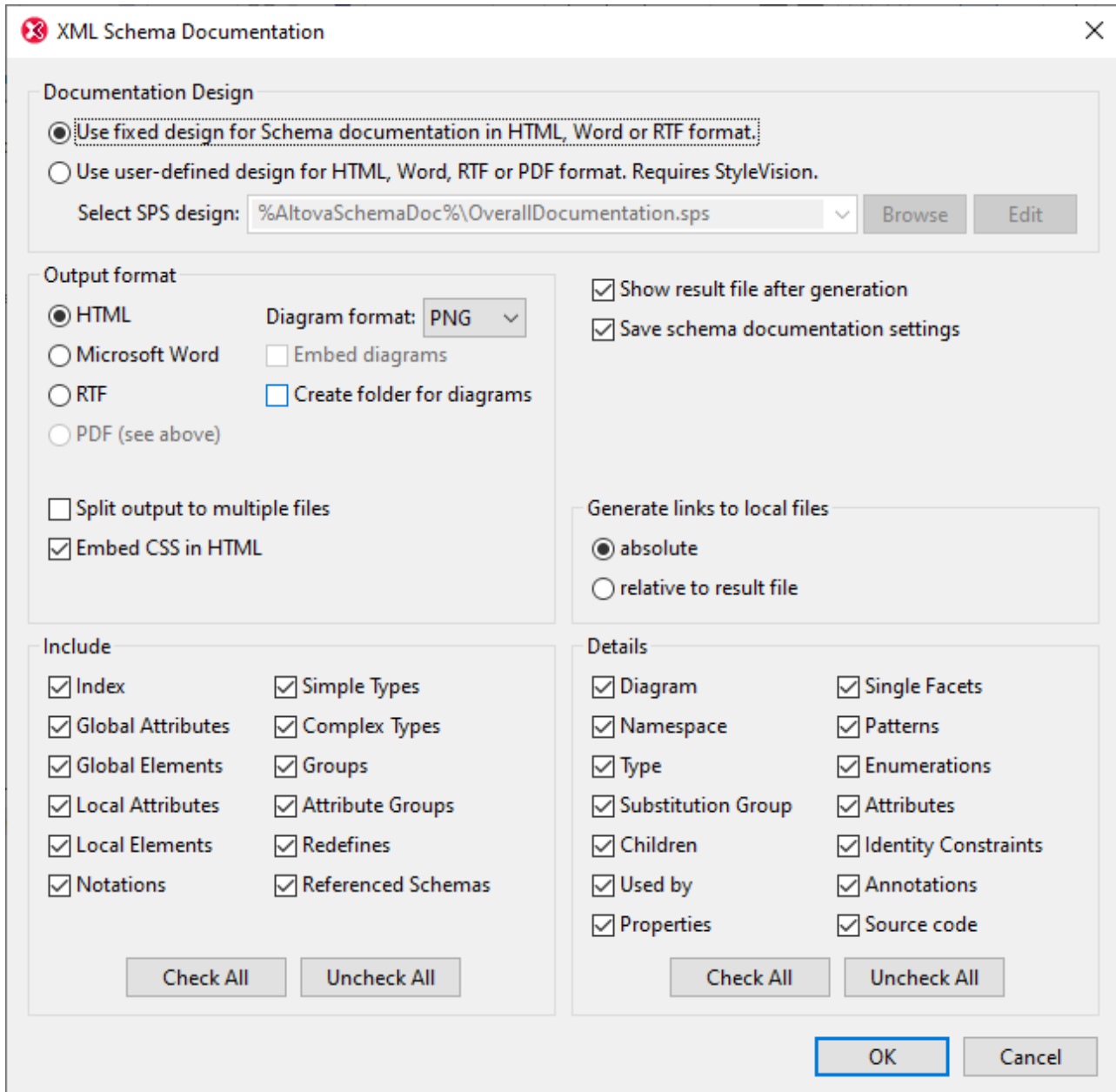

Click to expand/collapse

The other options in the Schema Documentation dialog are explained below:

- The required format is specified in the Output Format pane: either HTML, Microsoft Word, RTF, or PDF. (The PDF output format is only available if you use a StyleVision SPS to generate the documentation.) On clicking **OK**, you will be prompted for the name of the output file and the location to which it should be saved.
- Microsoft Word documents are created with the `.doc` file extension when generated using a fixed design, and with a `.docx` file extension when generated using a StyleVision SPS.
- The PNG format for images is available in all output formats. The SVG image format is available in HTML and PDF output formats.

- The documentation can be generated either as a single file or be split into multiple files. When multiple files are generated, each file corresponds to a component. What components are included in the output is specified using the check boxes in the Include pane. In fixed designs, links between multiple documents are created automatically.
- For HTML output, the CSS style definitions can be either saved in a separate CSS file or embedded in the HTML file (in the `<head>` element). If a separate CSS file is created, it will be given the same name as the HTML file, but will have a `.css` extension. Check or uncheck the *Embed CSS in HTML* check box to set the required option.
- The *Embed Diagrams* option is enabled for the MS Word, RTF, and PDF output options. When this option is checked, diagrams are embedded in the result file, in PNG or SVG format. Otherwise diagrams are created as image files (PNG or SVG), which are displayed in the result file via object links.
- When the output is HTML, all diagrams are created as document-external PNG files. If the *Create folder for diagrams* check box is checked, then a folder will be created in the same folder as the HTML file, and the PNG files will be saved inside it. This folder will have a name of the format `HTMLFilename_diagrams`. If the *Create folder for diagrams* check box is unchecked, the image files will be saved in the same folder as the HTML file.
- Links to local files (such as diagram image files and external CSS file) can be relative or absolute. In the *Generate links to local files* pane, select the appropriate radio button according to the option you prefer.
- In the Include pane, you select which item types you want to include in the documentation. Each item of the selected types will be displayed in the generated documentation. For example, if *Local Attributes* is checked, then the description of each local attribute is displayed as a separate entry. The Index option lists all related schemas at the top of the file, with their global components organized by component type. The **Check All** and **Uncheck All** buttons enable you to quickly select or deselect all the options in the pane. Note that the *Include* option does not affect the display of an item type within the graphical definitions. That display is controlled by the settings you make in the [Schema Display Configuration](#) ⁸⁹³ dialog. So if you wish to disable the display of attributes within the graphical representation of a schema item, then uncheck the Attributes option in the [Schema Display Configuration](#) ⁸⁹³ dialog.
- The Details pane lists the details that may be included for each component. Select the details you wish to include in the documentation. The **Check All** and **Uncheck All** buttons enable you to quickly select or deselect all the options in the pane.
- The *Show Result File* option is enabled for all output options. When this option is checked, the result files are displayed in Browser View (HTML output), MS Word (MS Word output), and the default applications for `.rtf` files (RTF output) and `.pdf` files (PDF output).

Parameter values

If the StyleVision SPS contains one or more parameter definitions, then on clicking **OK**, a dialog pops up listing all the parameters defined in the SPS. You can enter parameter values in this dialog to override the default parameter values that were assigned in the SPS.

25.7.3.2 User-Defined Design

Instead of the fixed standard XMLSpy design, you can create a customized design for schema documentation. The customized design is created in a StyleVision SPS, which is a design template for the output document.

Creating the SPS

A StyleVision Power Stylesheet (or SPS) is created using [Altova's StyleVision](#) product. An SPS for generating schema documentation must be based on an XML Schema that specifies the structure of the schema documentation. This schema is called `SchemaDocumentation.xsd`, and it is delivered with your XMLSpy package. It is stored in the folder: `C:\Documents and Settings\\My Documents\Altova\XMLSpy2024\Documentation\Schema`.

When creating the SPS design in StyleVision, nodes from the `SchemaDocumentation.xsd` schema are placed in the design template and assigned styles and properties. Additional components, like links, tables and images, can also be added to the SPS design. In this way, the entire output document can be designed in the SPS. How to create an SPS design in StyleVision is described in detail in the StyleVision user manual.

The advantage of using an SPS for generating schema documentation is that you have complete control over the schema documentation design. Note also that PDF output of the schema documentation is available only if a user-defined SPS is used; PDF output is not available if the fixed XMLSpy design is used.

Specifying the SPS to use for schema documentation

After an SPS has been created, it can be used to generate schema documentation. The SPS you wish to use for generating the schema documentation is selected in the Schema Documentation dialog (accessed via the **Schema Design | Generate Documentation** command). In the Documentation Design pane of this dialog (see screenshot below), select the *Use User-Defined Design* radio button. You can then click the **Browse** button and browse for the SPS you want. Click the dialog's **OK** button, and, in the Save dialog that pops up, select the folder for, and enter the name of, the output file.

Note: The SPS file must correctly locate the schema on which it is based: `SchemaDocumentation.xsd` (see above).

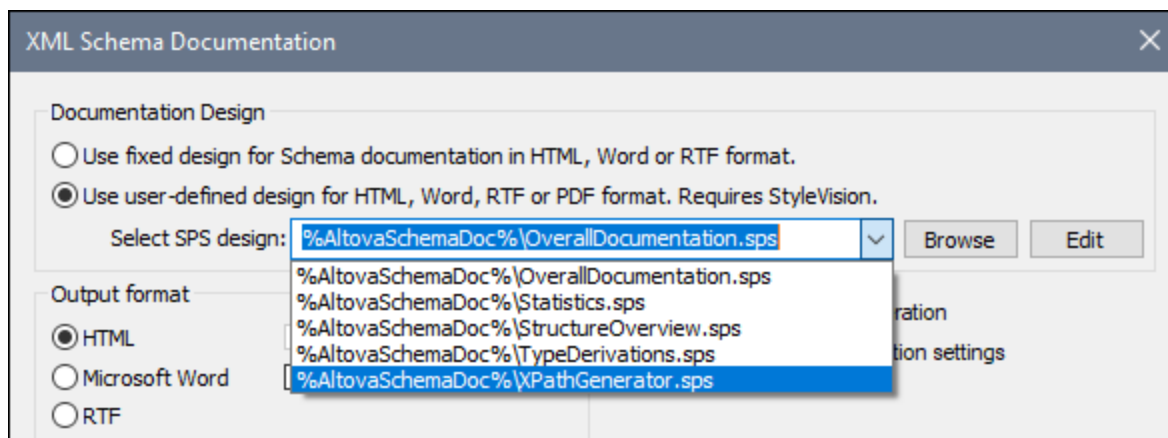

The following editable SPS designs for schema documentation generation are delivered with XMLSpy. They are in the `Altova\XMLSpy2024\Documentation\Schema\` subfolder of the [\(My\) Documents folder](#)²⁸:

- `OverallDocumentation.sps`, which generates full documentation about the schema
- `Statistics.sps`, which lists the number of global and local elements, attributes and attribute groups, and simple and complex types for the main schema and for each schema file independently
- `StructureOverview.sps`, which outputs a structure of global elements and complex types up to a configurable depth

- `TypeDerivations.sps`, which lists simple and complex types and all their directly and indirectly derived types in the form of a tree
- `XPathGenerator.sps`, which generates all possible XPath statements up to a configurable depth

These files, together with other SPS files you have recently browsed for, will be available in the combo box of the *Use User-Defined* option (see *screenshot above*).

Clicking the **Edit** button in the Documentation Design pane launches StyleVision and opens the selected SPS in a StyleVision window. In order to preview the result document in StyleVision, you will need a Working XML file. The SPS designs listed above have already been assigned a sample XML file named `Sample.xml`, which is located in the [\(My\) Documents folder](#)²⁸, in the following subfolder:

```
Altova\XMLSpy2024\Documentation\Schema\SampleData
```

Note: In order to use an SPS to generate schema documentation, you must have StyleVision installed on your machine.

25.7.4 Configure View



The **Schema Design | Configure view** command is active in Content Model View and allows you to configure the Content Model View. Clicking the command opens the Schema Display Configuration dialog at the bottom right of the XMLSpy window, enabling you to see the effect of your settings as you enter them in the dialog. The settings take effect when you click the **OK** button of the dialog, and apply to the Content Model View of all XML Schema files that are opened subsequently. These settings also apply to the [schema documentation output](#)⁸⁸⁷ and printer output. For example, if you wish to disable the display of attributes within the graphical representation of a schema item in the schema documentation output, then uncheck the *Attributes* option in the [Schema Display Configuration](#)⁸⁹³ dialog (*screenshot below*).

Note: For a description of how to configure JSON Schema Design View, see the section [Configuring JSON Schema Design View](#)⁵⁵⁷.

Defining property descriptor lines for the content model

You can define what properties of elements and attributes are displayed in the Content Model View. These properties appear as grid lines in component boxes.

To define property descriptor lines:

1. Select **Schema Design | Configure View**. The Schema display configuration dialog appears.
2. In the **Element** or **Attribute** tab, click the Append  or Insert  icon to add a property descriptor line. The line is added in the dialog and to element boxes in the Content Model View.
3. From the combo box, select the property you want to display. See *screenshot*.
4. Repeat steps 2 and 3 for as many properties as required.

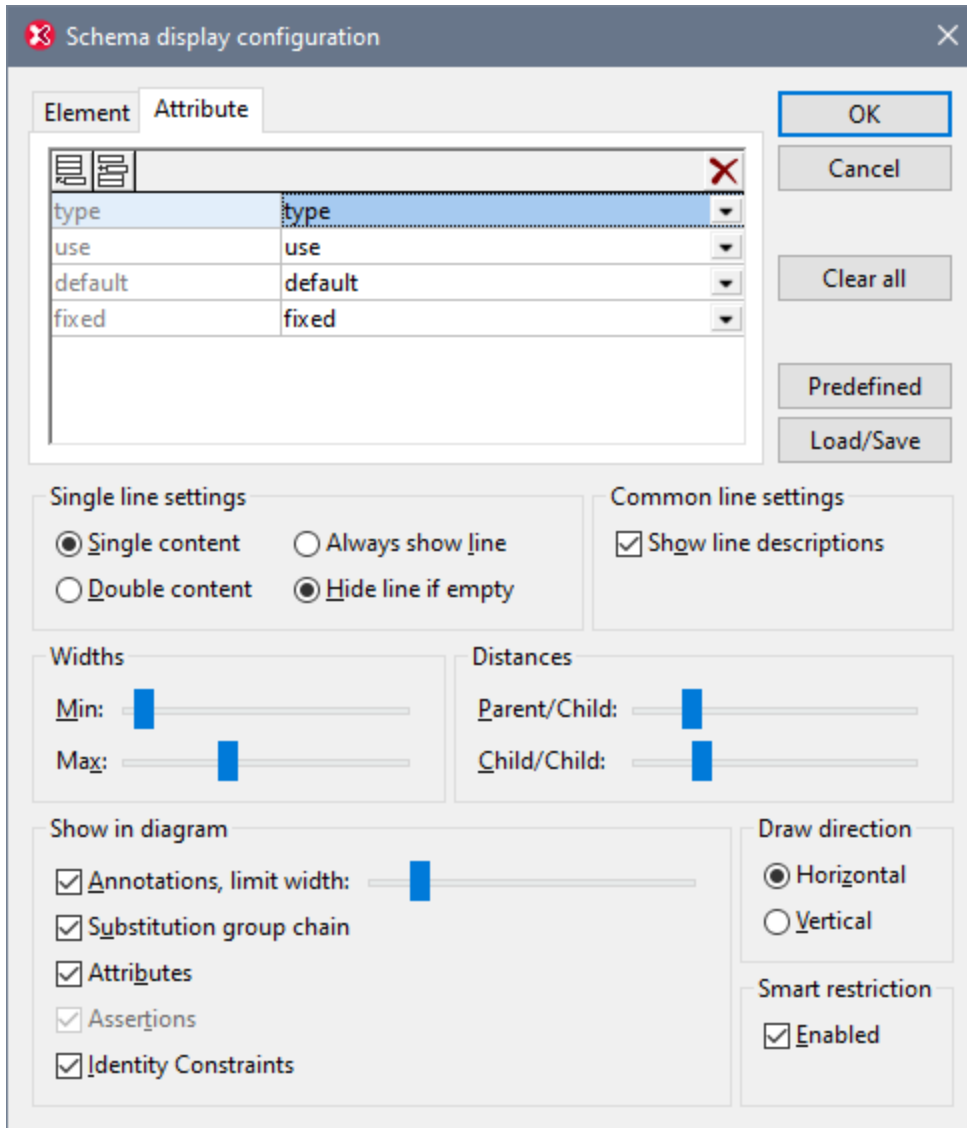

The Content Model View is updated, showing the defined property descriptor lines for all elements for which they exist.

Note: For attributes, the configuration you define appears only when attributes are displayed in the diagram (as opposed to them being displayed in a pane below the Content Model View). The configured view applies to all Content Model Views opened after the configuration is defined.

Deleting a property descriptor line from the Content Model View

To delete individual property descriptor lines, in the Schema Display Configuration dialog, select the property descriptor line you want to delete, and click the Delete icon .

Settings for configuring the Content Model View

The Content Model View can be configured using settings in the Schema Display Configuration dialog. How to define what property descriptor lines are displayed in Content Model View has been described above. The other settings are described below.

Single line settings

You can define whether a property descriptor line is to contain single or double content, and whether individual lines must appear for every element or only for elements that contain that property. Use the appropriate radio buttons to define your settings. Note that these two settings can be set for individual lines separately (select the required line and make the setting).

Common line settings

This option toggles the line descriptions (i.e. the name of the property) on and off.

Widths

These sliders enable you to set the minimum and maximum size of the element rectangles in Content Model View. Change the sizes if line descriptor text is not fully visible or if you want to standardize your display.

Distances

These sliders let you define the horizontal and vertical distances between various elements onscreen.

Show in diagram

The Annotations check box toggles the display of annotation text on or off, as well as the annotation text width with the slider. You can also toggle the display of the substitution groups on or off. The Attributes and Identity Constraints appear in the Content Model diagram if their check boxes are selected; otherwise they appear as tabs in a pane at the bottom of the Content Model window.

Draw direction

These options define the orientation of the element tree on screen, horizontal or vertical.

Editing the content model in the diagram itself

You can change element properties directly in the content model diagram. To do this, double-click the property you wish to edit and start entering data. If a selection is available, a drop-down list appears, from which you can select an option. Otherwise, enter a value and confirm with **Enter**.

Buttons in the Schema display configuration dialog

This dialog has the following buttons:

- The **Load/Save** button allows you to load and save the settings you make here.
- The **Predefined** button, resets the display configuration to default values.
- The **Clear all** button empties the list box of all entries.

Enabling smart restrictions

To enable [smart restrictions](#)²⁶⁷, check the Enable Schema Restrictions check box.

25.7.5 Zoom

The **Schema Design | Zoom** command controls the zoom factor of the Content Model View. This feature is useful if you have a large content model and wish to zoom out so that the entire content model fits in the Main Window. You can zoom between 10% and 200% of actual size.

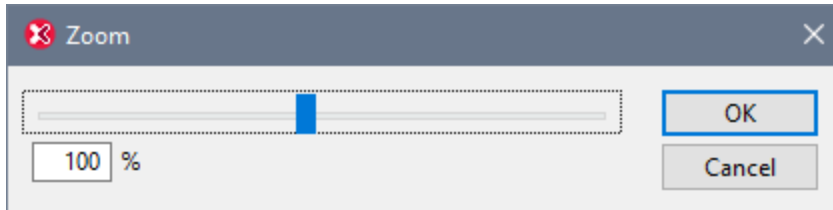

To zoom in and out, either drag the slider or click in the entry box and enter a percentage value.

25.7.6 Display All Globals

The **Schema Design | Display All Globals** command switches from [Content Model View](#)²¹⁶ to [Schema Overview](#)²⁰⁴ to display all global components in the schema. It is a toggle with the Display Diagram command. The currently selected toggle is indicated with a check mark to its left (see *screenshot*).



Alternatively, you could use the **Display All Globals** icon  at the top of the Content Model View to switch to the Schema Overview.

25.7.7 Display Diagram

The **Schema Design | Display Diagram** command switches to the [Content Model View](#)²¹⁶ of the selected global component—if the selected component has a content model. Global components that have a content model (complex types, elements, and element groups) are indicated with the  icon to its left. The Display Diagram command is a toggle with the Display All Globals command. The currently selected toggle is indicated with a check mark to its left (*screenshot below*).

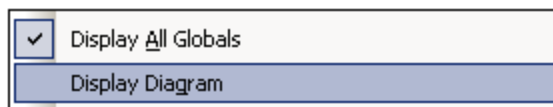

Alternatively, you could use the following methods to switch to Content Model View:

- Click the  icon next to the component, the content model of which you want to display.

- Double-click a component name in the Component Navigator Entry Helper (at top right).

25.7.8 Schema Extensions for Databases

This menu item pops out a sub-menu containing commands for Oracle and MS SQL Server schema extensions.

- [Enable Oracle Schema Extensions](#) ⁸⁹⁷
- [Oracle Schema Settings](#) ⁸⁹⁸
- [Enable Microsoft SQL Server Schema Extensions](#) ⁸⁹⁹
- [Named Schema Relationships](#) ⁹⁰⁰
- [Unnamed Element Relationships](#) ⁹⁰⁰

25.7.8.1 Enable Oracle Schema Extensions

XMLSpy provides support for Oracle schema extensions for use with Oracle 9i Project XDB. Using these schema extensions allows you to configure and customize how Oracle 9i Project XDB stores XML documents. These XML documents are then accessible through SQL queries and legacy tools. Please see the [Oracle Website](#) for more information.

When you select the **Enable Oracle Schema Extensions** command, the following occurs:

- The XDB namespace is declared on the `schema` element:
`xmlns:xdb="http://xmlns.oracle.com/xdb"`.
- An Oracle tab is created in the Details Entry Helper, enabling you to add attributes—including XDB-specific attributes—to schema elements such as `xsd:complexType` and `xsd:element`.

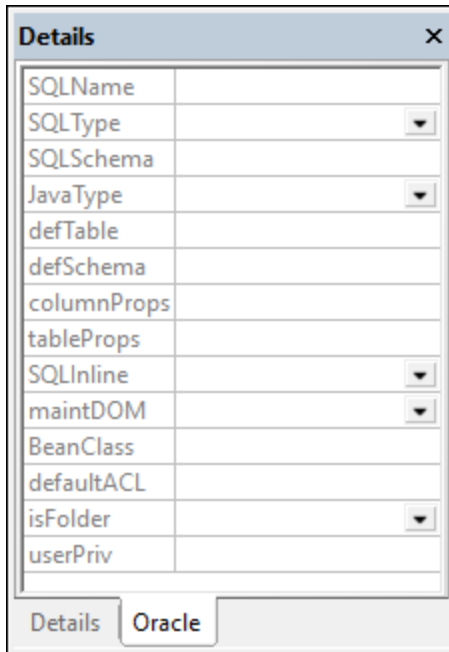

Oracle extensions can be defined for complex types, elements, and attributes. Use the Entry Helper as you normally would in XMLSpy.

Note: These extensions can be switched on or off by toggling the menu command on/off. When extensions are enabled, the command is displayed with a check mark to its left. When extensions are switched off the XDB namespace declaration and all XDB extensions in the file are deleted. A warning message appears since this action cannot be undone.

25.7.8.2 Oracle Schema Settings

The **Oracle Schema Settings** command allows you to define global settings for Oracle schema extensions.

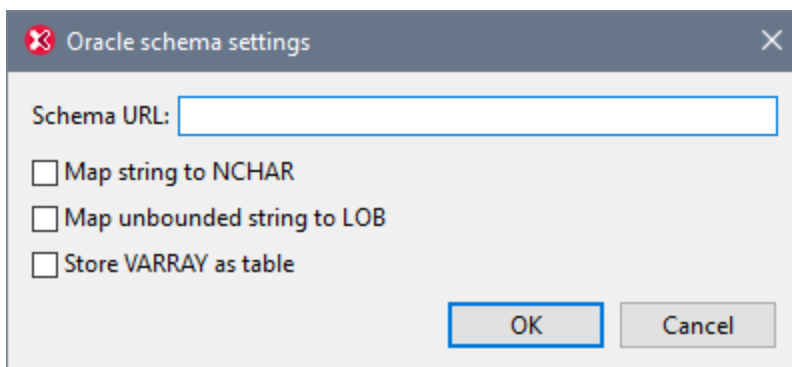

In order to access this dialog, Oracle schema extensions must be enabled (using the [Enable Oracle Schema Extensions](#)⁸⁹⁷ command).

25.7.8.3 Enable Microsoft SQL Server Schema Extensions

XMLSpy provides support for Microsoft SQL Server 2000 schema extensions for use with Microsoft SQL Server. Using these schema extensions allows you to configure and customize how Microsoft SQL Server stores XML documents. These XML documents are then accessible through SQL queries and legacy tools. Please see the [Microsoft Website](#) for more information.

When you select the **Enable Microsoft SQL Server Schema Extensions** command, the following occurs:

- The SQL Server namespace is declared on the `schema` element: `xmlns:sql="urn:schemas-microsoft-com:mapping-schema"`.
- An SQL Server tab is created in the Details Entry Helper, enabling you to add attributes to schema elements such as `xsd:element`.

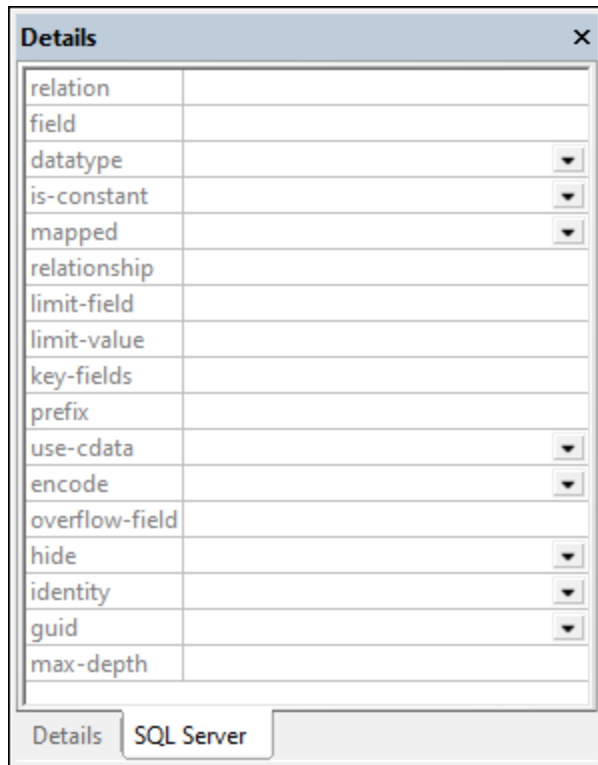



Where SQL Server extensions can be defined for a schema component, the SQL Server tab is available in the Details Entry Helper when the component is selected. Use the Entry Helper as you normally would in XMLSpy.

Note: These extensions can be switched on or off by toggling the menu command on/off. When extensions are enabled, the command is displayed with a check mark to its left. When extensions are switched off, the SQL Server namespace declaration and all SQL Server extensions in the file are deleted. A warning message appears since this action cannot be undone.

25.7.8.4 Named Schema Relationships

The **Named Schema Relationships** command allows the definition of named relationships to provide the information needed to create the document hierarchy. You have to have previously enabled the SQL Server schema extensions, using the menu option "Enable SQL Server Schema Extensions", to be able to access this menu option.

To create a named schema relationship:

1. Click the insert  or append icon , to add a new row to the dialog box.
2. Click the field and enter the corresponding relationship name.
3. Click **OK** to confirm.

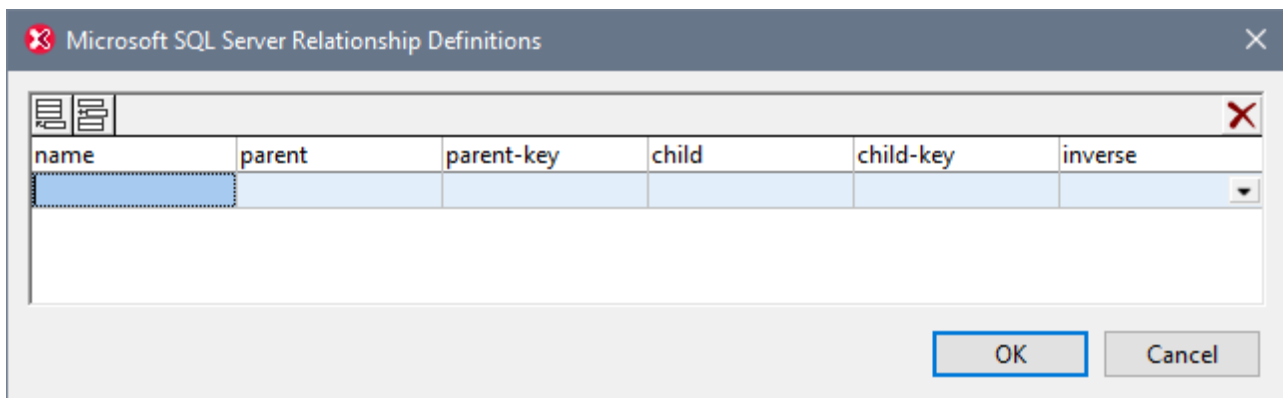



This generates a SQL relationship element, placing it just after the namespace declaration.

Note: Click the delete icon , to delete a row from the dialog box.

25.7.8.5 Unnamed Element Relationships

The **Unnamed Element Relationships** command allows the definition of unnamed relationships to provide the information needed to create the document hierarchy. You have to have previously enabled the SQL Server schema extensions, using the menu option **Enable Microsoft SQL Server Schema Extensions**, to be able to access this menu option.

To create an unnamed schema relationship:

1. Click the insert  or append icon , to add a new row to the dialog box.
2. Click the field and enter the corresponding name.
3. Click **OK** to confirm.

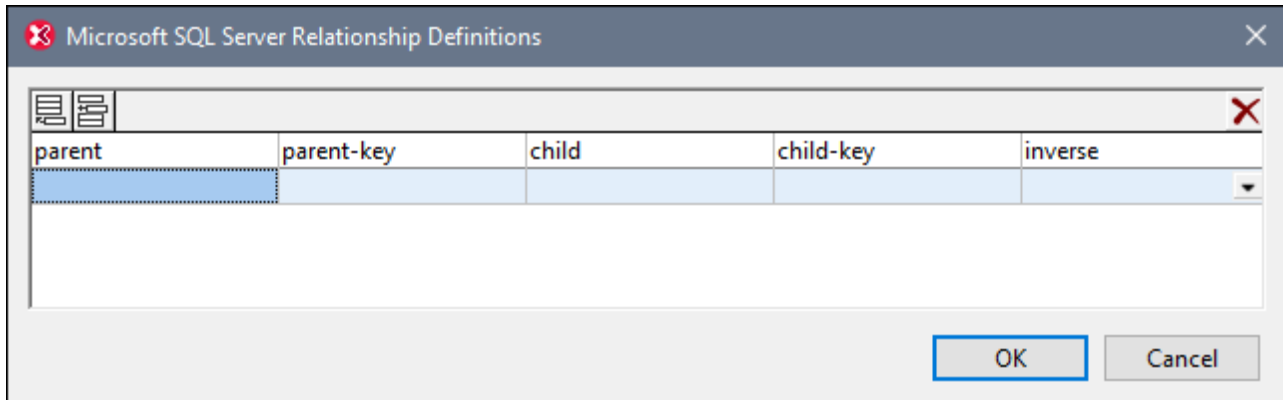

This generates a SQL relationship element for the currently selected schema element.

Note: Click the delete icon , to delete a row from the dialog box.

25.7.9 Connect to SchemaAgent Server



The **Schema Design | Connect to SchemaAgent Server** command is enabled when an XML Schema document is active and it enables you to connect to a SchemaAgent Server. You are able to connect to a SchemaAgent server only if a licensed Altova SchemaAgent product is installed on your machine. When you click this command, the Connect to SchemaAgent Server dialog (*screenshot below*) opens:

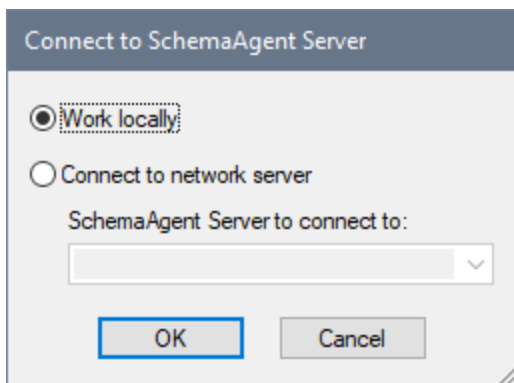

You can use either the local server (the SchemaAgent server that is packaged with Altova SchemaAgent) or a network server (the Altova SchemaAgent Server product, which is available free of charge). If you select **Work Locally**, the local server of SchemaAgent will be started when you click **OK** and a connection with it will be established. If you select **Connect to Network Server**, the selected SchemaAgent Server must be running in order for a connection to be made.

When connected to SchemaAgent Server, XMLSpy acts as a SchemaAgent client, and provides powerful and enhanced schema editing and management functionality. For details about SchemaAgent, the installation of SchemaAgent Server, and how to connect to SchemaAgent Server, see [SchemaAgent](#)³³⁷ in the DTD and XML Schema section of this user manual. For more information about installing and working with these two products, see the SchemaAgent user manual that is delivered with these products.

After you connect to SchemaAgent Server, a message appears in the bar at the top of the Main Window with information about the connection. You now have full access to all schemas and schema components in the search path/s (folder/s) defined for the SchemaAgent server to which XMLSpy is connected.

Note: In order for the connection to succeed, you must have Altova's SchemaAgent Client product installed with a valid license on the same machine as that on which XMLSpy is installed.

25.7.10 Disconnect from SchemaAgent Server



The **Disconnect from SchemaAgent Server** command is enabled when a connection to a SchemaAgent Server has been made successfully. Selecting this command disconnects XMLSpy from the SchemaAgent Server.

25.7.11 Show in SchemaAgent

The **Show in SchemaAgent** menu item causes the active schema and, optionally, linked schemas to be displayed in the Altova product SchemaAgent. (This product must be installed on the same machine as XMLSpy if you wish to use SchemaAgent functionality). The schema/s are opened in a new SchemaAgent Design in SchemaAgent.

Mousing over the **Show in SchemaAgent** menu item pops out a submenu with options about what schemas to show in SchemaAgent. These options are described in [SchemaAgent](#)³⁴⁵ in the DTD and XML Schema section of this user manual.

25.7.12 SchemaAgent Validation



The **SchemaAgent Validation** command enables you to validate the currently active schema as well as schemas related to the currently active schema. This feature is described in detail in the [SchemaAgent Validation](#)³⁴⁵ section in the Schema View section of this user manual.

25.7.13 Create Schema Subset

The **Create Schema Subset** command pops up the Select Schema Components dialog (*screenshot below*). In this dialog, you check the component or components you wish to create as a single schema subset, then click **Next**. (Note that a check box below the pane enables components from all referenced files to also be listed for selection.)

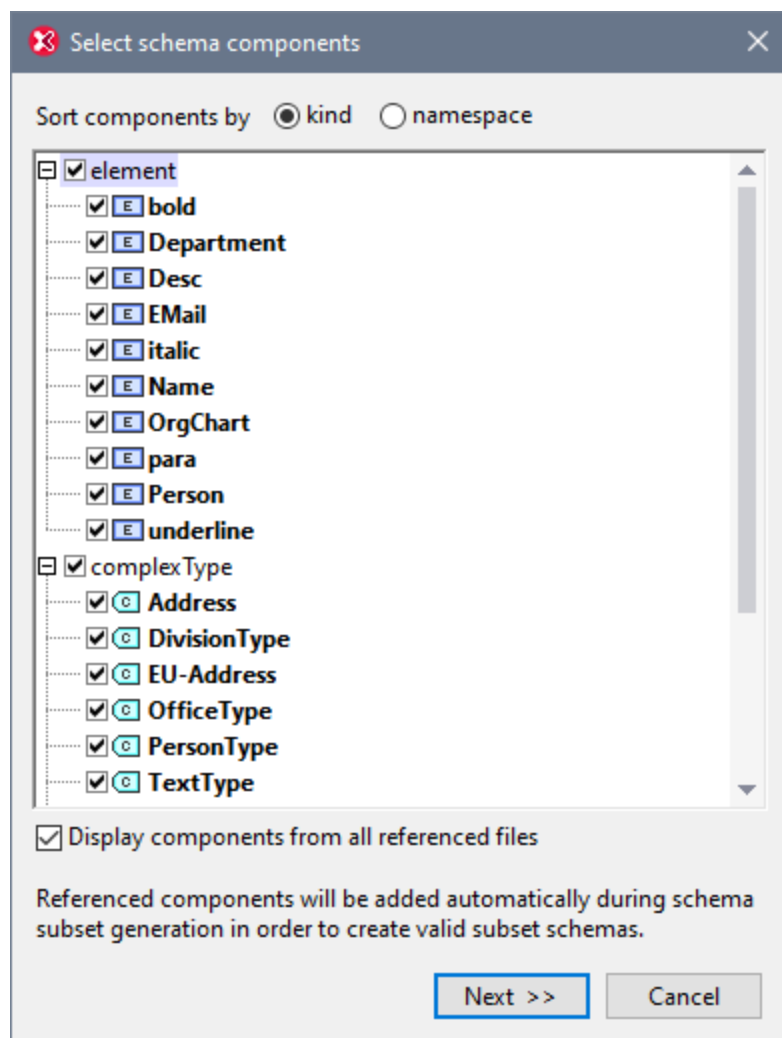

In the Schema Subset Generation dialog that now appears (*screenshot below*), enter the name/s you want the file/s of the schema subset package to have. You must also specify the folder in which the new schema subset files are to be saved. A schema subset package could have multiple files if one or more of the components being created is an imported component in the original schema. A separate schema file is created for each namespace in the schema subset. The filenames displayed in the dialog are, by default, the names of the original files. But since you are not allowed to overwrite the original files, use new filenames if you wish to save the files in the same folder as the original files.

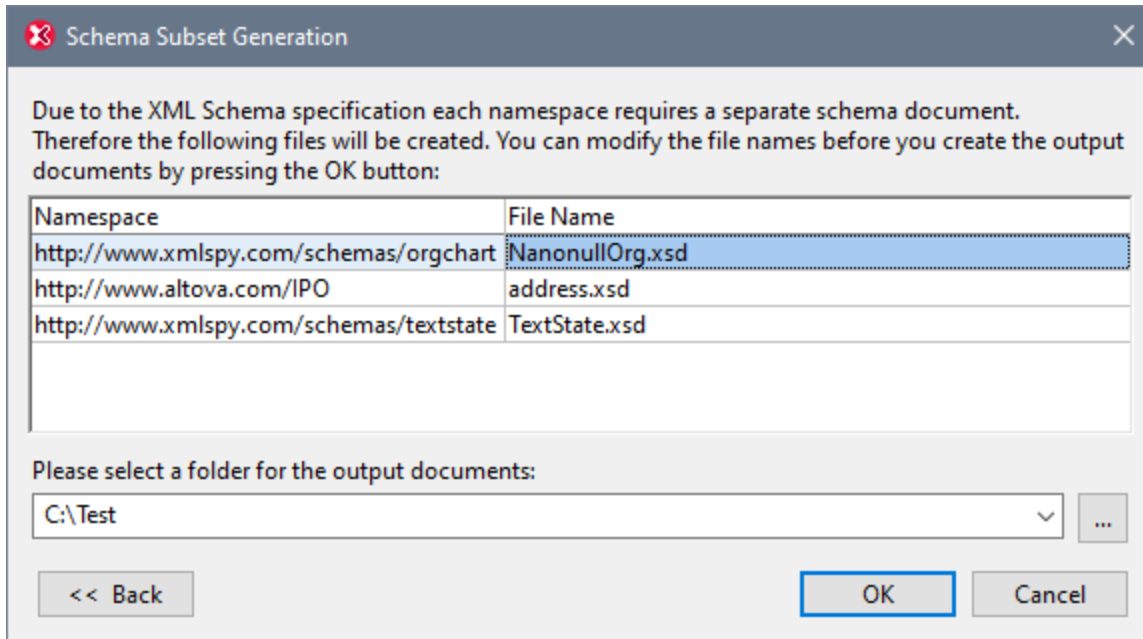

On clicking **OK**, the schema subset file with the namespace corresponding to that of the active file is opened in Schema View. Any other files in the package are created but not opened in Schema View.

25.7.14 Flatten Schema

Flattening the active schema in Schema View is the process of: (i) adding the components of all included schemas as global components of the active schema, and (ii) deleting the included schemas.

To flatten the active schema, select the command **Schema Design | Flatten Schema**. This pops up the Flatten Schema dialog (*screenshot below*), which contains the names of separate files, one for each namespace that will be in the flattened schema. These default names are the same as the original filenames. But since you are not allowed to overwrite the original files, the filenames must be changed if you wish to save in the same folder as the active file. You can browse for a folder in which the flattened schema and its associated files will be saved.

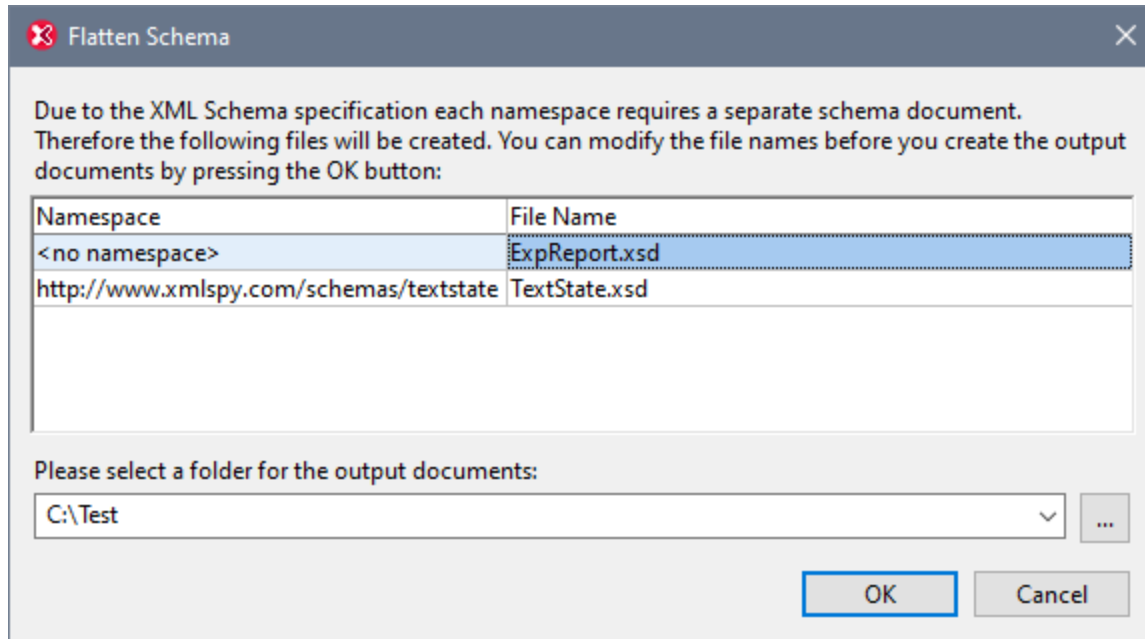

On clicking **OK**, the flattened schema file will be opened in Schema View.

25.8 XSL/XQuery Menu

The XSL Transformation language lets you specify how an XML document should be converted into other XML documents or text files. One kind of XML document that is generated with an XSLT document is an FO document, which can then be further processed to generate PDF output. XMLSpy contains built-in XSLT processors (for XSLT 1.0, XSLT 2.0, and XSLT 3.0) and can link to an FO processor on your system to transform XML files and generate various kinds of outputs. The location of the FO processor must be specified in the XSL section of the Options dialog ([Tools | Options](#)¹⁰⁶⁸) in order to be able to use it directly from within the XMLSpy interface.

XMLSpy also has a built-in XQuery engine, which can be used to execute XQuery documents (with or without reference to an XML document).

Commands to deal with all the above transformations are accessible in the **XSL/XQuery** menu. In addition, this menu also contains commands to work with the Altova XSLT/XQuery Debugger.

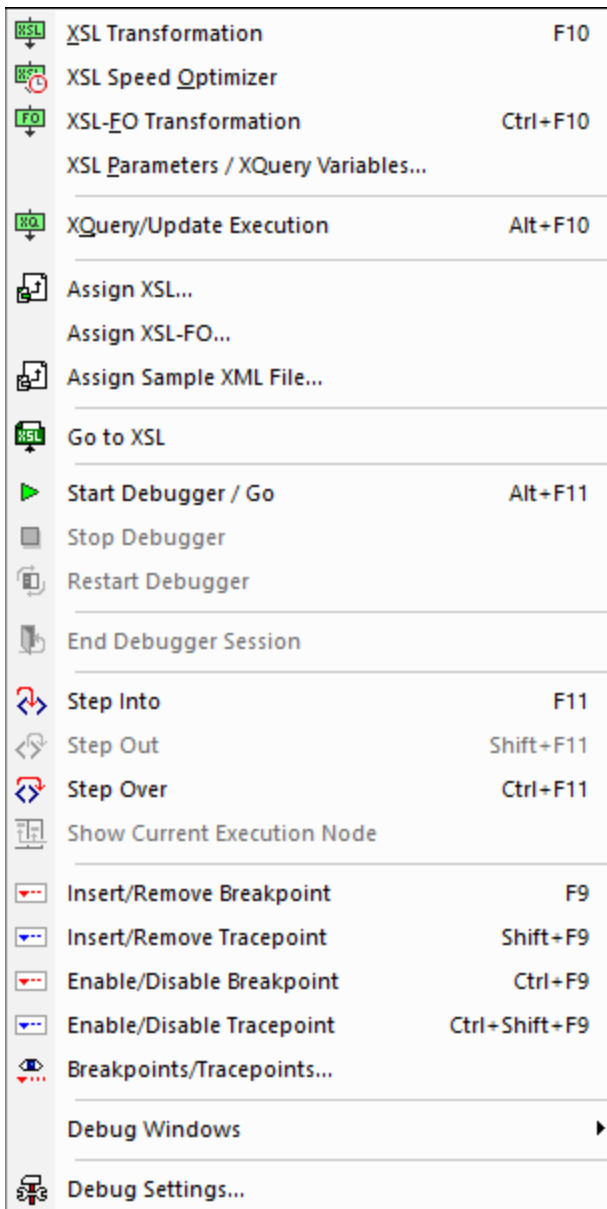

25.8.1 XSL Transformation



F10

The **XSL/XQuery | XSL Transformation** command transforms an XML document using an assigned XSLT stylesheet. The transformation can be carried out using the appropriate built-in Altova XSLT Engine (Altova XSLT 1.0 Engine for XSLT 1.0 stylesheets; Altova XSLT 2.0 Engine for XSLT 2.0 stylesheets; Altova XSLT 3.0 Engine for XSLT 3.0 stylesheets), the Microsoft-supplied MSXML module, or an external XSLT processor. The

processor that is used in conjunction with this command is specified in the [XSL section](#)¹⁰⁶⁸ of the Options dialog (**Tools | Options**).

If your XML document contains a reference to an XSLT stylesheet, then this stylesheet is used for the transformation. (An XSLT stylesheet can be assigned to an XML document using the [Assign XSL](#)⁹¹³ command. If the XML document is part of a project, an XSLT stylesheet can be specified on a per-folder basis in the [Project Properties](#)⁸⁴⁹ dialog. Right-click the project folder/s or file/s you wish to transform and select XSL Transformation.) If an XSLT stylesheet has not been assigned to an XML file, you are prompted for the XSLT stylesheet to use. You can also select a file via a global resource or a URL (click the [Browse](#)⁷⁸⁷ button) or a file in one of the open windows in XMLSpy (click the **Window** button).

Automating validation with RaptorXML 2024

RaptorXML is Altova's standalone application for XML validation, XSLT transformation, and XQuery transformation. It can be used from the command line, via a COM interface, in Java programs, and in .NET applications. XSLT transformation tasks can therefore be automated with the use of RaptorXML. For example, you can create a batch file that calls RaptorXML to run XSLT transformations on a set of documents and sends the output to a text file. See the [RaptorXML documentation](#) for details.

Transformations to ZIP files

In order to enforce output to a ZIP file, including Open Office XML (OOXML) files such as .docx, one must specify the ZIP protocol in the file path of the output file. For example:

```
filename.zip|zip/filename.xxx
```

```
filename.docx|zip/filename.xxx
```

Note: The directory structure might need to be created before running the transformation. If you are generating files for an Open Office XML archive, you would need to zip the archive files in order to create the top-level OOXML file (for example, .docx).

25.8.2 XSL-FO Transformation



Ctrl+F10

FO is an XML format that describes paged documents. An FO processor, such as the Apache XML Project's FOP, takes an FO file as input and generates PDF as output. The production of a PDF document from an XML document is, therefore, a two-step process.

1. The XML document is transformed to an FO document using an XSLT stylesheet.
2. The FO document is processed by an FO processor to generate PDF (or some alternative output).

The **XSL/XQuery | XSL:FO Transformation** command transforms an XML document or an FO document to PDF.

- If the **XSL:FO Transformation** command is executed on a source XML document, then both of the steps listed above are executed, in sequence, one after the other. If the XSLT stylesheet required to transform to FO is not referenced in the XML document, you are prompted to assign one for the

transformation. Note that you can also select a file via a global resource or a URL (click the [Browse](#)⁷⁸⁷ button) or a file in one of the open windows in XMLSpy (click the **Window** button). The transformation from XML to XSL-FO is carried out by the XSLT processor specified in the [XSL section](#)¹⁰⁶⁸ of the Options dialog (**Tools | Options**). By default the selected XSLT processor is XMLSpy's built-in XSLT processor. The resultant FO document is directly processed with the FO processor specified in the [XSL section](#)¹⁰⁶⁸ of the Options dialog (**Tools | Options**).

- If the **XSL:FO Transformation** command is executed on an FO document, then the document is processed with the FO processor specified in the [XSL section](#)¹⁰⁶⁸ of the Options dialog (**Tools | Options**).

XSL:FO Transformation output

The **XSL:FO Transformation** command pops up the Choose XSL:FO Output dialog (*screenshot below*). (If the active document is an XML document without an XSLT assignment, you are first prompted for an XSLT file.)

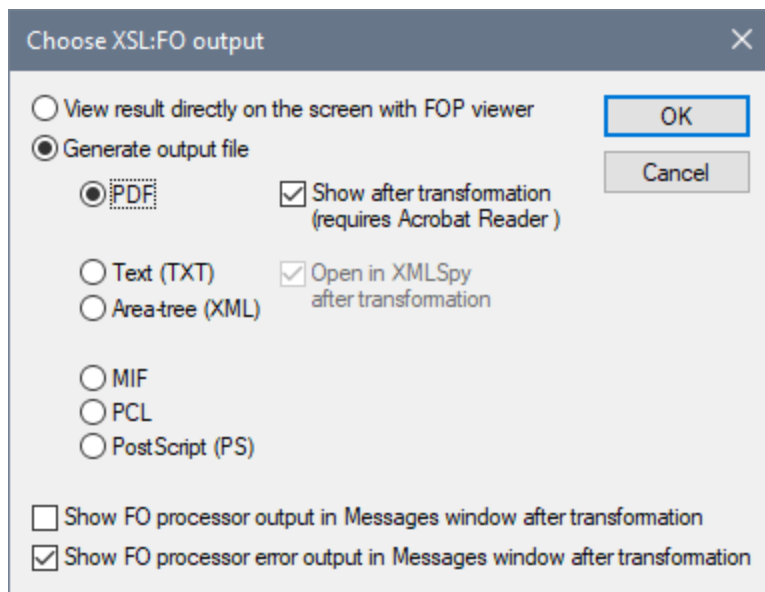

You can view the output of the FO processor directly on screen using FOP viewer or you can generate an output file in any one of the following formats: PDF, text, an XML area tree, MIF PCL, or PostScript. You can also switch on messages from the FO processor to show (i) the processor's standard output message in the Messages window; and (ii) the processor's error messages in the Messages window. To switch on either of these two options, check the appropriate check box at the bottom of the dialog.

Note:

- Unless you deselected the option to install the FOP processor of the [Apache XML Project](#), it will have been installed in the folder `C:\ProgramData\Altova\SharedBetweenVersions`. If installed, the path to it will automatically have been entered in the [XSL section](#)¹⁰⁶⁸ of the Options dialog (**Tools | Options**) as the FO processor to use. You can set the path to any FO processor you wish to use.
- The XSL:FO Transformation command can not only be used on the active file in the Main Window but also on any file or folder you select in the active project. To do this, right-click and select **XSL:FO Transformation**. The XSLT stylesheet assigned to the selected project folder is used.

25.8.3 XSL Parameters / XQuery Variables

The **XSL/XQuery | XSL Parameters/XQuery Variables** command opens the XSLT Input Parameters/XQuery External Variables dialog (see *screenshot*). You can enter the name of one or more parameters you wish to pass to the XSLT stylesheet, or one or more external XQuery variables you wish to pass to the XQuery document, and their respective values. These parameters are used as follows in XMLSpy:

- When the **XSL Transformation** command in the XSL/XQuery menu is used to transform an XML document, the parameter values currently saved in the dialog are passed to the selected XSLT document and used for the transformation.
- When the **XQuery Execution** command in the XSL/XQuery menu is used to process an XQuery document, the XQuery external variable values currently saved in the dialog are passed to the XQuery document for the execution.

Note: Parameters or variables that you enter in the XSLT Input Parameters/XQuery External Variables dialog are only passed on to the built-in Altova XSLT engine. Therefore, if you are using MSXML or another external engine that you have configured, these parameters are not passed to this engine.

Note: It is not an error if an XSLT parameter or external XQuery variable is defined in the XSLT Input Parameters/XQuery External Variables dialog but is not used in the XSLT/XQuery document or the transformation.

Using XSLT Parameters

The value you enter for the parameter can be an XPath expression without quotes or a text string delimited by quotes. If the active document is an XSLT document, the **Get from XSL** button will be enabled. Clicking this button inserts parameters declared in the XSLT into the dialog together with their default values. This enables you to quickly include declared parameters and then change their default values as required.

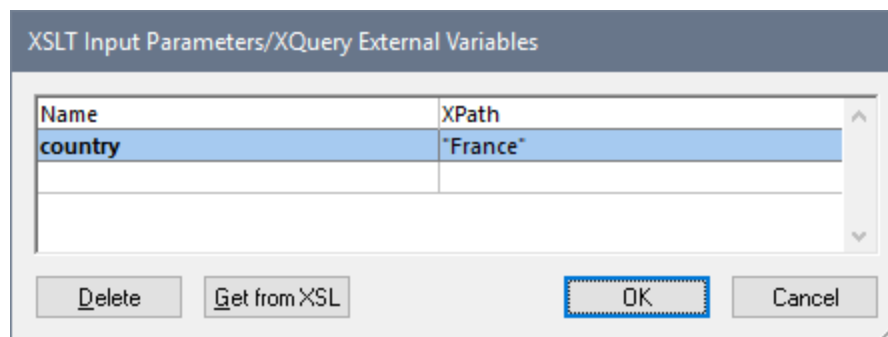

Note: Once a set of parameter-values is entered in the dialog, it is used for all subsequent transformations until it is explicitly deleted or the application is restarted. Parameters entered in the dialog are specified at the application-level for that session, and will be passed to the respective XSLT document for every transformation that is carried out via the IDE from that moment onward. This means that:

- parameters are not associated with any particular document
- any parameter entered in the dialog is erased once XMLSpy has been closed.

Usage example for XSLT parameters

We have an XML document that contains the names of countries and their respective capitals:

```
<document>
  <countries>
    <country name="USA" capital="Washington DC"/>
    <country name="UK" capital="London"/>
    <country name="France" capital="Paris"/>
    <country name="Russia" capital="Moscow"/>
    <country name="China" capital="Beijing"/>
  </countries>
</document>
```

The following XSLT document will generate an XML document that displays one country from the XML file together with that country's capital. The country is selected by entering its name as the value of the parameter named `country` (shown highlighted in yellow below).

```
<xsl:stylesheet version="2.0" xmlns:xsl="http://www.w3.org/1999/XSL/Transform">
  <xsl:param name="country" select="'USA'"/>
  <xsl:template match="countries">
    <xsl:for-each select="country[@name=$country]">
      <country>
        <name><xsl:value-of select="$country"/></name>
        <capital><xsl:value-of select="@capital"/></capital>
      </country>
    </xsl:for-each>
  </xsl:template>
</xsl:stylesheet>
```

When this XSLT document is run on the XML document listed above, the result will be this:

```
<country><name>USA</name><capital>Washington DC</capital></country>
```

Now, if in the XSLT Input Parameters/XQuery External Variables dialog you create a parameter named `country` and give it a value (see *screenshot above*), then this value will be passed to the parameter `country` in the XSLT stylesheet for the transformation. In this way, you can pass different values to different parameters at run time.

Note:

- If you use the **XSL:FO Transformation** command (**XSL/XQuery | XSL:FO Transformation**), then parameters entered in the XSLT Input Parameters/XQuery External Variables dialog are **not** passed to the stylesheet. In order for these parameters to be used in PDF output, first transform from XML to FO using the XSLT Transformation command (**XSL/XQuery | XSL Transformation**), and then transform the FO to PDF using the **XSL:FO Transformation** command (**XSL/XQuery | XSL:FO Transformation**).
- If you use an XSLT processor other than the built-in Altova XSLT Engines, parameters you enter using the Input Parameters dialog will not be passed to the external processor.

Using external XQuery variables

The value you enter for an external XQuery variable could be an XPath expression without quotes or a text string delimited by quotes. The datatype of the external variable is specified in the variable declaration in the XQuery document.

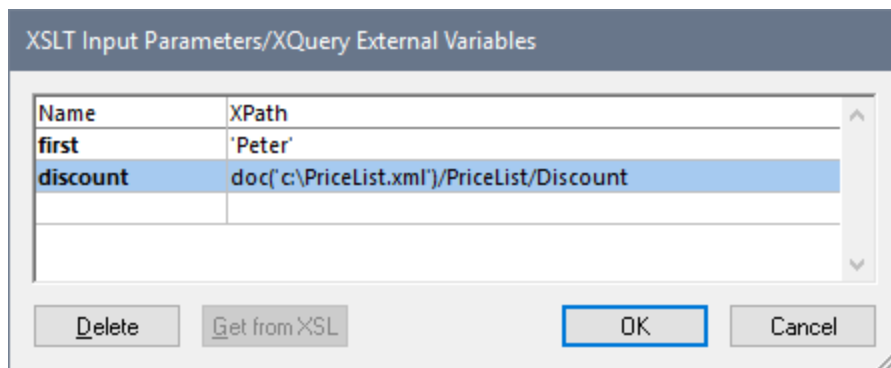

Note: Once a set of external XQuery variables are entered in the dialog, they are used for all subsequent executions until they are explicitly deleted or the application is restarted. Variables entered in the dialog are specified at the application-level, and will be passed to the respective XQuery document for every execution that is carried out via the IDE from that moment onward. This means that:

- Variables are not associated with any particular document
- Any variable entered in the dialog is erased once the application (XMLSpy) has been closed down.

Usage example for external XQuery variables

In the following example, a variable `$first` is declared in the XQuery document and is then used in the return clause of the FLWOR expression:

```
xquery version "1.0";
declare variable $first as xs:string external;
let $last := "Jones"
return concat($first, " ", $last )
```

This XQuery returns `Peter Jones`, if the value of the external variable (entered in the XSLT Input Parameters/XQuery External Variables dialog) is `Peter`. Note the following:

- The `external` keyword in the variable declaration in the XQuery document indicates that this variable is an external variable.
- Defining the static type of the variable is optional. If a datatype for the variable is not specified in the variable declaration, then the variable value is assigned the type `xs:untypedAtomic`.
- If an external variable is declared in the XQuery document, but no external variable of that name is passed to the XQuery document, then an error is reported.
- If an external variable is declared and is entered in the XSLT Input Parameters/XQuery External Variables dialog, then it is considered to be in scope for the XQuery document being executed. If a new variable with that name is declared within the XQuery document, the new variable temporarily overrides the in-scope external variable. For example, the XQuery document below returns `Paul Jones` even though the in-scope external variable `$first` has a value of `Peter`.

```
xquery version "1.0";
```

```
declare variable $first as xs:string external;
let $first := "Paul"
let $last := "Jones"
return concat($first, " ", $last )
```

25.8.4 XQuery/Update Execution



The **XSL/XQuery | XQuery/ Update Execution** command executes an XQuery (1.0/3.1) or XQuery Update (1.0/3.0) document. Depending on whether the selected file is an XQuery or XQuery Update file, either an XQuery execution or an XQuery update is carried out. XMLSpy recognizes the type of document (XQuery or XQuery Update) on the basis of the document's [file type association](#)¹⁰⁴³ (defined in the [File types section of the Options dialog](#)¹⁰⁴³).

The XQuery Engine to use (1.0 or 3.1) is selected automatically on the basis of the version declaration in the document. If there is no version declaration in the document, then the default version specified in the [XQuery section of the Options dialog](#)¹⁰⁷¹ is used. The **XQuery/ Update Execution** command can be invoked when an XQuery, XQuery Update, or XML file is active. When invoked from an XML file, it opens a dialog asking for an XQuery file to associate with the XML file. You can also select a file via a global resource or a URL (click the [Browse](#)⁷⁸⁷ button) or a file in one of the open windows in XMLSpy (click the **Window** button).

Note: The command is also available in the context menu of [Project window](#)¹¹⁰ items.

Automating validation with RaptorXML 2024

RaptorXML is Altova's standalone application for XML validation, XSLT transformation, and XQuery transformation. It can be used from the command line, via a COM interface, in Java programs, and in .NET applications. XQuery execution tasks can therefore be automated with the use of RaptorXML. For example, you can create a batch file that calls RaptorXML to run XQuery executions on a set of documents and sends the output to a text file. See the [RaptorXML documentation](#) for details.

25.8.5 Assign XSL



The **XSL/XQuery | Assign XSL...** command assigns an XSLT stylesheet to an XML document. Clicking the command opens a dialog to let you specify the XSLT file you want to assign. You can also select a file via a global resource or a URL (click the [Browse](#)⁷⁸⁷ button) or a file in one of the open windows in XMLSpy (click the **Window** button).

An `xml-stylesheet` processing instruction is inserted in the XML document:

```
<?xml-stylesheet type="text/xsl" href="C:\workarea\recursion\recursion.xslt"?>
```

Note: You can make the path of the assigned file relative by clicking the *Make Path Relative To* check box.

25.8.6 Assign XSL-FO

The **XSL/XQuery | Assign XSL:FO** command assigns an XSLT stylesheet for transformation to FO to an XML document. The command opens a dialog to let you specify the XSL or XSLT file you want to assign and inserts the required processing instruction into your XML document.

You can make the path of the assigned file relative by clicking the *Make Path Relative To* check box. You can also select a file via a global resource or a URL (click the **Browse** ⁷⁸⁷ button) or a file in one of the open windows in XMLSpy (click the **Window** button).

Note: An XML document may have two XSLT files assigned to it: one for standard XSLT transformations, a second for an XSLT transformation to FO.

25.8.7 Assign Sample XML File



The **XSL/XQuery | Assign Sample XML File** command assigns an XML file to an XSLT document. The command inserts a processing instruction naming an XML file to be processed with this XSLT file when the XSL Transformation is executed on the XSLT file:

```
<?altova_samplexml C:\workarea\html2xml\article.xml?>
```

Note: You can make the path of the assigned file relative by clicking the *Make Path Relative To* check box. You can also select a file via a global resource or a URL (click the **Browse** ⁷⁸⁷ button) or a file in one of the open windows in XMLSpy (click the **Window** button).

25.8.8 Go to XSL



The **XSL/XQuery | Go to XSL** command opens the associated XSLT document. If your XML document contains a stylesheet processing instruction (i.e. an XSLT assignment) such as this:

```
<?xml-stylesheet type="text/xsl" href="Company.xsl"?>
```

then the **Go to XSL** command opens the XSLT document in XMLSpy.

25.8.9 Start Debugger / Go



Alt+F11

The **XSL/XQuery | Start Debugger/Go** command starts or continues processing the XSLT/XQuery document till the end. If breakpoints have been set, then processing will pause at that point. If tracepoints have been set, output for these statements will be displayed in the Trace window when the closing node of the statement with the tracepoint has been reached. If the debugger session has not been started, then this button will start the session and stop at the first node to be processed. If the session is running, then the XSLT/XQuery document will be processed to the end, or until the next breakpoint is encountered.

25.8.10 Stop Debugger



The **XSL/XQuery | Stop Debugger** command stops the debugger. This is not the same as stopping the debugger **session** in which the debugger is running. This is convenient if you wish to edit a document in the middle of a debugging session or to use alternative files within the same debugging session. After stopping the debugger, you must restart the debugger to start from the beginning of the XSLT/XQuery document.

25.8.11 Restart Debugger



The **XSL/XQuery | Restart Debugger** command clears the output window and restarts the debugging session with the currently selected files.

25.8.12 End Debugger Session



The **XSL/XQuery | End Debugger Session** command ends the debugging session and returns you to the normal XMLSpy view that was active before you started the debugging session. Whether the output documents that were opened for the debugging session stay open depends on a setting you make in the [XSLT/XQuery Debugger Settings](#)⁴¹⁷ dialog.

25.8.13 Step Into



F11

The **XSL/XQuery | Step Into** command proceeds in single steps through all nodes and XPath expressions in the stylesheet. This command is also used to re-start the debugger after it has been stopped.

25.8.14 Step Out



Shift+F11

The **XSL/XQuery | Step Out** command steps out of the current node to the next sibling of the parent node, or to the next node at the next higher level from that of the parent node.

25.8.15 Step Over



Ctrl+F11

The **XSL/XQuery | Step Over** command steps over the current node to the next node at the same level, or to the next node at the next higher level from that of the current node. This command is also used to re-start the debugger after it has been stopped.

25.8.16 Show Current Execution Node



The **XSL/XQuery | Show Current Execution Node** command displays/selects the current execution node in the XSLT/XQuery document and the corresponding context node in the XML document. This is useful when you have clicked in other tabs which show or mark specific code in the XSLT stylesheet or XML file, and you want to return to where you were before you did this.

25.8.17 Insert/Remove Breakpoint

**F9**

The **XSL/XQuery | Insert/Remove Breakpoint** command inserts or removes a breakpoint at the current cursor position. Inline breakpoints can be defined for nodes in both the XSLT/XQuery and XML documents, and determine where the processing should pause. A dashed red line appears above the node when you set a breakpoint. Breakpoints cannot be defined on closing nodes, and breakpoints on attributes in XSLT documents will be ignored. This command is also available by right-clicking at the breakpoint location.

25.8.18 Insert/Remove Tracepoint

**Shift+F9**

The **XSL/XQuery | Insert/Remove Tracepoint** command inserts or removes a tracepoint at the current cursor position in an XSLT/XQuery document. For statements with a tracepoint, during debugging, the value of the statement is displayed in the Trace window when the closing node of that statement is reached. A dashed blue line appears above the node when you set a tracepoint. Tracepoints cannot be defined on closing nodes. This command is also available by right-clicking at the tracepoint location.

25.8.19 Enable/Disable Breakpoint

**Ctrl+F9**

The **XSL/XQuery | Enable/Disable Breakpoint** command enables or disables already defined breakpoints. The red breakpoint highlight turns to gray when the breakpoint is disabled. The debugger does not stop at disabled breakpoints. To disable/enable a breakpoint, place the cursor in that node name and click the **Enable/Disable Breakpoint** command. This command is also available by right-clicking at the location where you want to enable/disable the breakpoint.

25.8.20 Enable/Disable Tracepoint

**Ctrl+Shift+F9**

The **XSL/XQuery | Enable/Disable Tracepoint** command enables or disables already defined tracepoints. The blue tracepoint highlight turns to gray when the tracepoint is disabled. No output is displayed for statements with disabled tracepoints. To disable/enable a tracepoint, place the cursor in that node name and

click the **Enable/Disable Tracepoint** command. This command is also available by right-clicking at the location where you want to enable/disable the tracepoint.

25.8.21 Breakpoints/Tracepoints



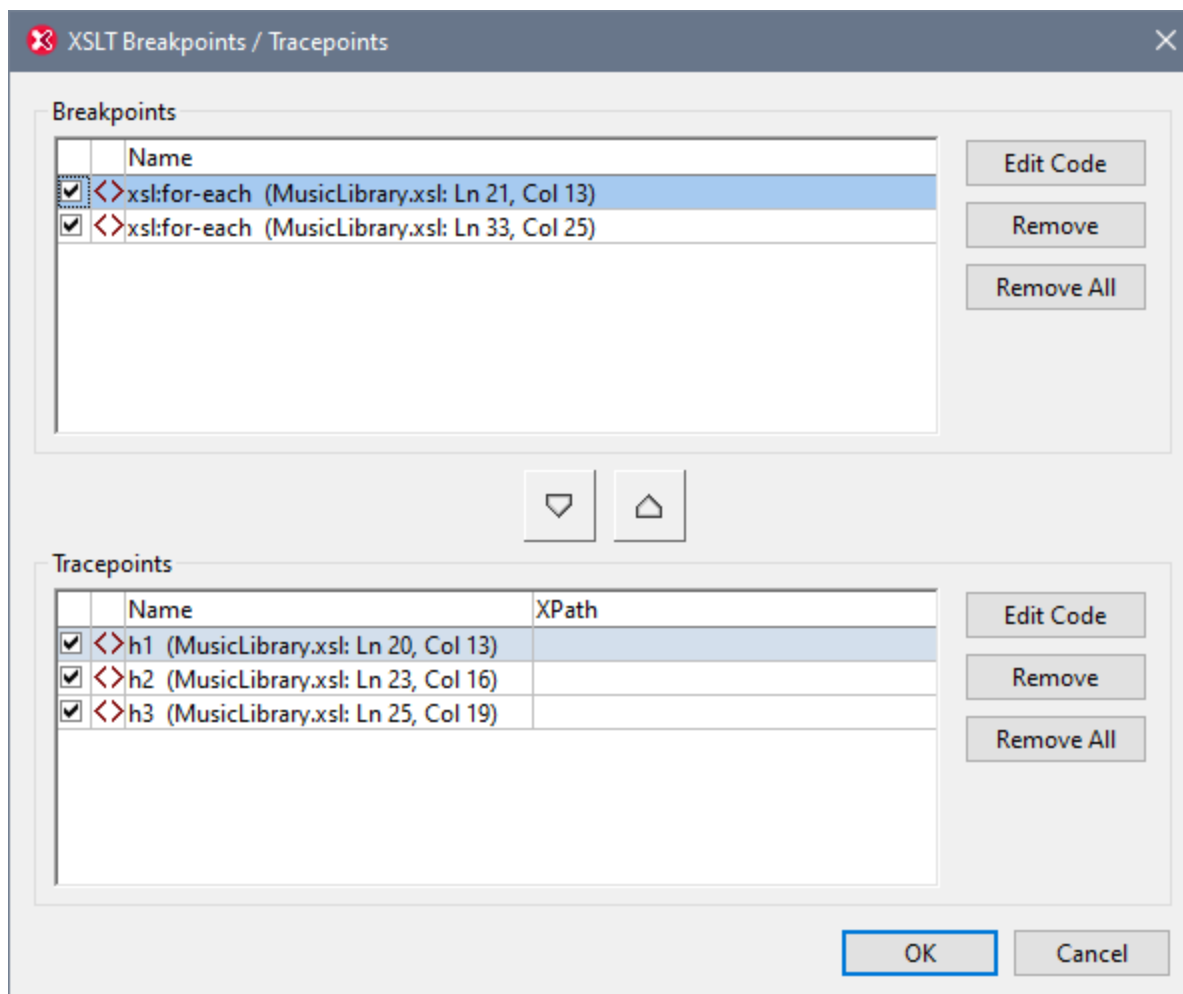

The **XSL/XQuery | Breakpoints/Tracepoints** command opens the XSLT Breakpoints/Tracepoints dialog. This displays a list of all currently defined breakpoints and tracepoints (including disabled breakpoints and tracepoints) in all files of the current debugging session.



The following features are available:

- The check boxes indicate whether a breakpoint or tracepoint is enabled (checked) or disabled.
- You can highlight one breakpoint or trace point at a time.
- Remove a highlighted breakpoint or tracepoint by clicking the corresponding **Remove** button.
- Remove all breakpoints or tracepoints by clicking the corresponding **Remove All** button.

- The **Edit Code** button takes you directly to the highlighted breakpoint or tracepoint in the corresponding file.
- Click  to move the highlighted breakpoint to the Tracepoints pane.
- Click  to move the highlighted tracepoint to the Breakpoints pane.
- In the XPath column of the Tracepoints pane, you can set an XPath for each tracepoint. This enables you to specify a condition that has to be met in order for the tracepoint to be applied.

25.8.22 Debug Windows

Placing the cursor over the **XSL/XQuery | Debug Windows** command pops out a submenu with a list of the various Information Windows of the XSLT/XQuery Debugger. Selecting an Information Window from this list shows/hides that Information Window in the XSLT/XQuery Debugger interface. This command can be used to effect only when a debugging session is in progress.

25.8.23 Debug Settings



The **XSL/XQuery | Debug Settings** command opens the [Debug Settings dialog](#)⁴¹⁷, which enables you to set user options for the Debugger. See the [XSLT/XQuery Debugger](#)³⁹⁹ section for details.

25.9 Authentic Menu

Authentic View enables you to edit XML documents **based on StyleVision Power Stylesheets (.sps files) created in Altova's StyleVision product!** These stylesheets contain information that enables an XML file to be displayed graphically in Authentic View. In addition to containing display information, StyleVision Power Stylesheets also allow you to write data to the XML file. This data is dynamically processed using all the capability available to XSLT stylesheets and instantly produces the output in Authentic View.

Additionally, StyleVision Power Stylesheets can be created to display an editable XML view of a database. The StyleVision Power Stylesheet contains information for connecting to the database, displaying the data from the database in Authentic View, and writing back to the database.

The **Authentic** menu contains commands relevant to editing XML documents in Authentic View. For a tutorial on Authentic View, see the [Authentic View Tutorials](#)⁴⁴⁶ section.

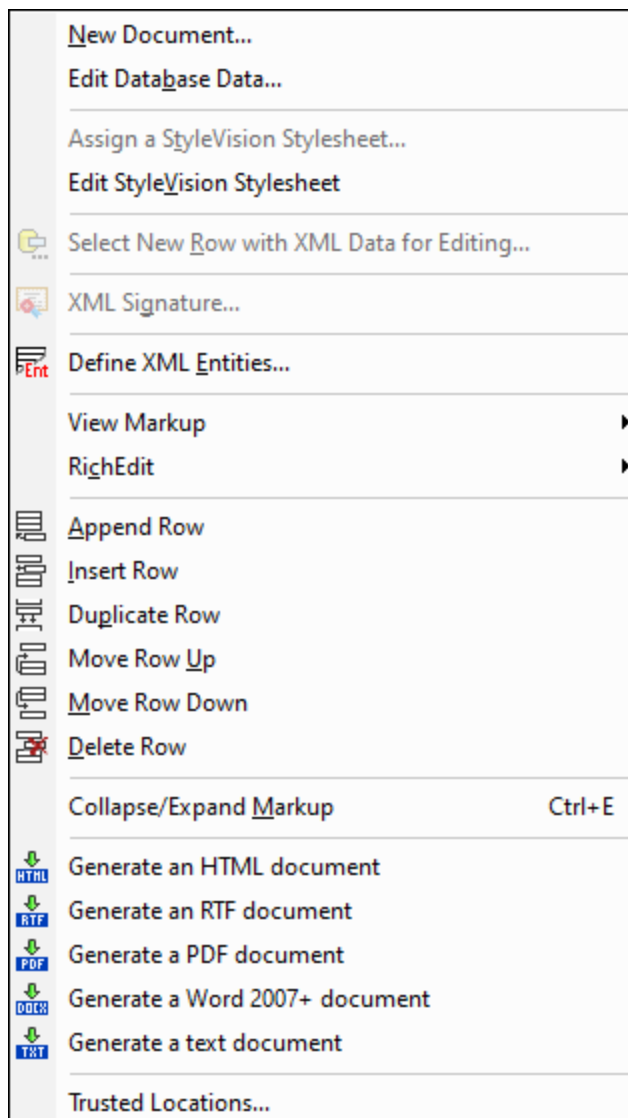

25.9.1 New Document

This command enables you to open a new XML document template in Authentic View. The XML document template is based on a StyleVision Power Stylesheet (.sps file), and is opened by selecting the StyleVision Power Stylesheet (SPS file) in the Create New Document dialog (*screenshot below*). On selecting an SPS and clicking **OK**, the XML document template defined for that SPS file is opened in Authentic View.

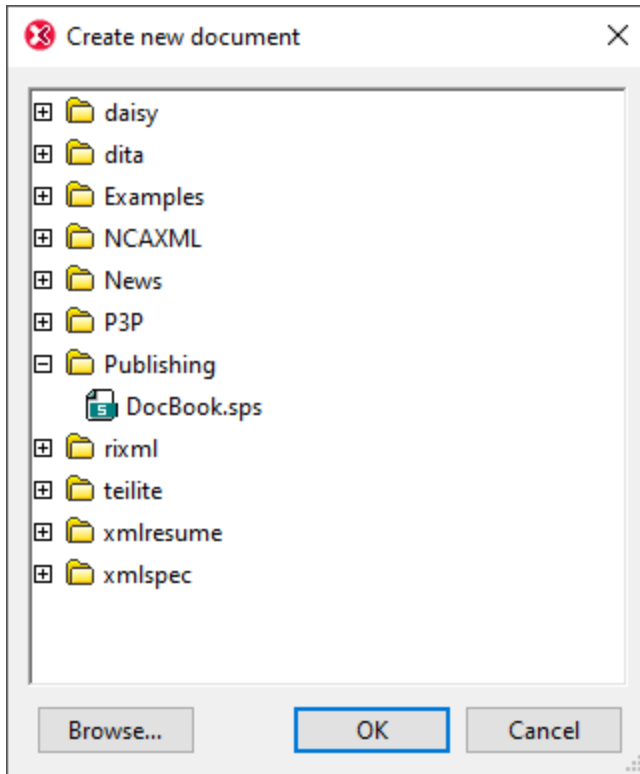

The Create New Document dialog offers a choice of XML document templates that are based on popular DTDs or schemas. Alternatively, you can browse for a custom-made SPS file that has a Template XML File assigned to it. SPS files are created using Altova StyleVision, an application that enables you to design XML document templates based on a DTD or XML Schema. After designing the required SPS in StyleVision, an XML file is assigned (in StyleVision) as a Template XML File to the SPS. The data in this XML file provides the starting data of the new document template that is opened in the Authentic View of XMLSpy.

The new XML document template will therefore have the documentation presentation properties defined in the SPS and the data of the XML file that was selected as the Template XML File. The Authentic View user can now edit the XML document template in a graphical WYSIWYG interface, and save it as an XML document.

25.9.2 Edit Database Data

The **Authentic | Edit Database Data** command opens an editable view of a database (DB) in Authentic View. All information about connecting to the DB, and how to display the DB and accept changes to it via Authentic View is contained in a StyleVision Power Stylesheet. The **Edit Database Data** command opens an StyleVision Power Stylesheet, sets up a connection to the DB, and displays the DB data (through an XML lens) in Authentic View.

On clicking **Edit Database Data** command, the Edit Database Data dialog (*screenshot below*) opens.

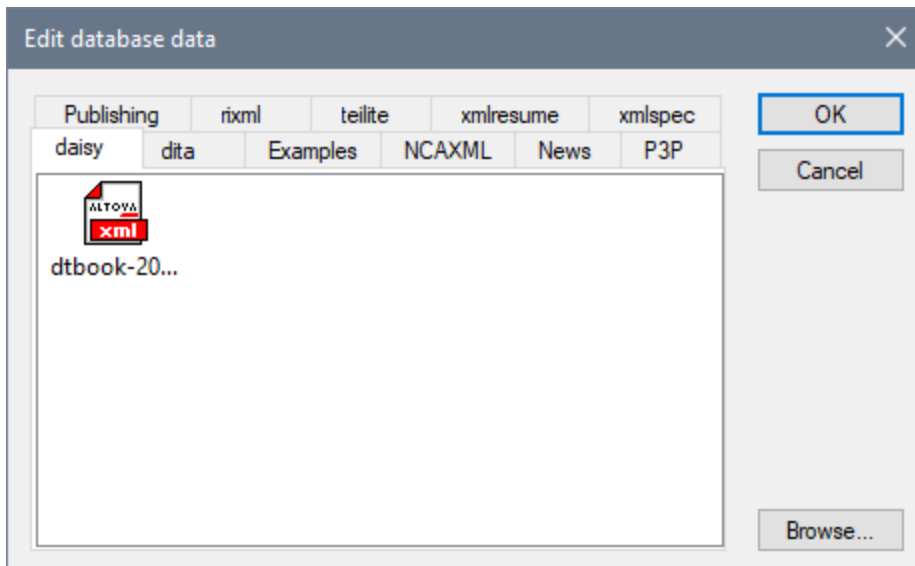

Browse for the required SPS file, and select it. This connects to the DB and opens an editable view of the DB in Authentic View. The design of the DB view that is displayed in Authentic View is contained in the StyleVision Power Stylesheet.

Note: If, with the **Edit Database Data** command, you attempt to open a StyleVision Power Stylesheet that is not based on a DB or to open a DB-based StyleVision Power Stylesheet that was created in a version of StyleVision prior to the StyleVision 2005 release, you will receive an error.

Note: StyleVision Power Stylesheets are created using Altova StyleVision.

25.9.3 Assign a StyleVision Stylesheet

The **Assign a StyleVision Stylesheet** command assigns a StyleVision Power Stylesheet (SPS) to an XML document to enable the viewing and editing of that XML document in Authentic View. The StyleVision Power Stylesheet that is to be assigned to the XML file must be based on the same schema as that on which the XML file is based.

To assign a StyleVision Power Stylesheet to an XML file:

1. Make the XML file the active file and select the **Assign a StyleVision Stylesheet** command.

2. The command opens a dialog box in which you specify the StyleVision Power Stylesheet file you wish to assign to the XML.
3. Click **OK** to insert the required SPS statement into your XML document. Note that you can make the path to the assigned file relative by clicking the *Make path relative to* check box. You can also select a file via a global resource or a URL (click the **Browse** ⁷⁸⁷ button) or a file in one of the open windows in XMLSpy (click the **Window** button).

```
<?xml version="1.0" encoding="UTF-8"?>  
<?altova_sps HTML-Orgchart.sps?>
```

In the example above, the StyleVision Power Stylesheet is called `HTML_Orgchart.sps`, and it is located in the same directory as the XML file.

Note: Previous versions of Altova products used a processing instruction with a target or name of `xmlspysps`, so a processing instruction would look something like `<?xmlspysps HTML-Orgchart.sps?>`. These older processing instructions are still valid with Authentic View in current versions of Altova products.

25.9.4 Edit StyleVision Stylesheet

The **Edit StyleVision Stylesheet** command is available only in Authentic View (which implies that the XML document has been assigned a StyleVision Power Stylesheet). The command starts StyleVision and allows you to edit the StyleVision Power Stylesheet immediately in StyleVision.

25.9.5 Select New Row with XML Data for Editing

The **Select New Row with XML Data for Editing** command enables you to select a new row from the relevant table in an XML DB (such as IBM DB2). This row appears in Authentic View, can be edited there, and then saved back to the DB.

When an XML DB is used as the XML data source, the XML data that is displayed in Authentic View is the XML document contained in one of the cells of the XML data column. The **Select New Row with XML Data for Editing** command enables you to select an XML document from another cell (or row) of that XML column. Selecting the **Select New Row** command pops up the Choose XML Field dialog (*screenshot below*), which displays the table containing the XML column.

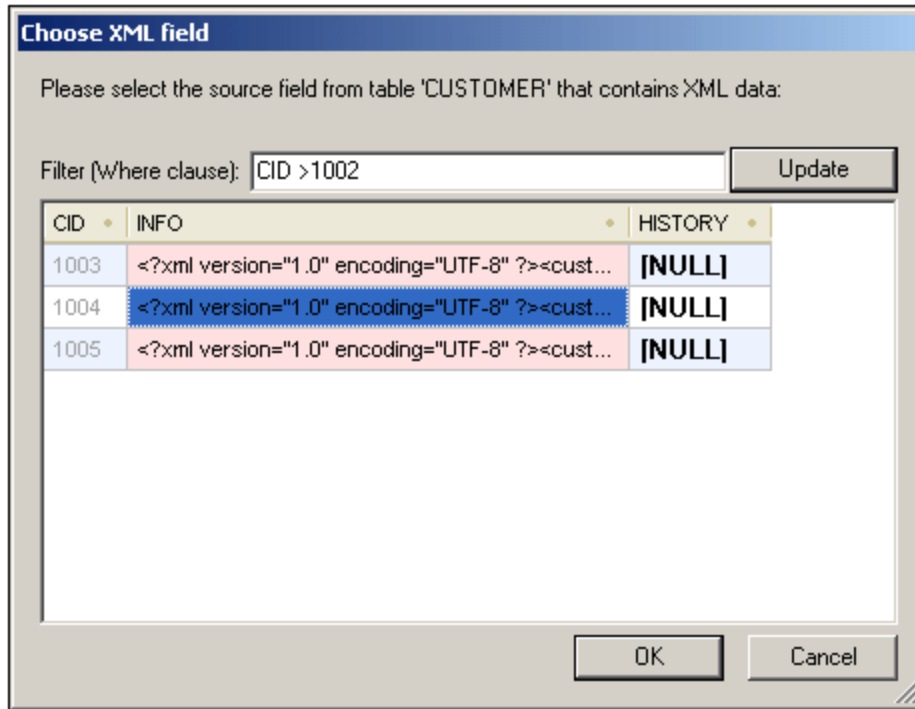

You can enter a filter for this table. The filter should be an SQL `WHERE` clause (just the condition, without the `WHERE` keyword, for example: `CID>1002`). Click **Update** to refresh the dialog. In the screenshot above, you can see the result of a filtered view. Next, select the cell containing the required XML document and click **OK**. The XML document in the selected cell (row) is loaded into Authentic View.

25.9.6 XML Signature

The **XML Signature** command is available in Authentic View when the associated SPS has XML Signatures enabled. The **XML Signature** command is also available as the XML Signature toolbar icon  in the Authentic toolbar.

Verification and own certificate/password

Clicking the **XML Signature** command starts the signature verification process. If no signature is present in the document, a message to that effect is displayed in the XML Signature dialog (see *screenshot below*), and the dialog will have a button that enables the Authentic View user to sign the document.

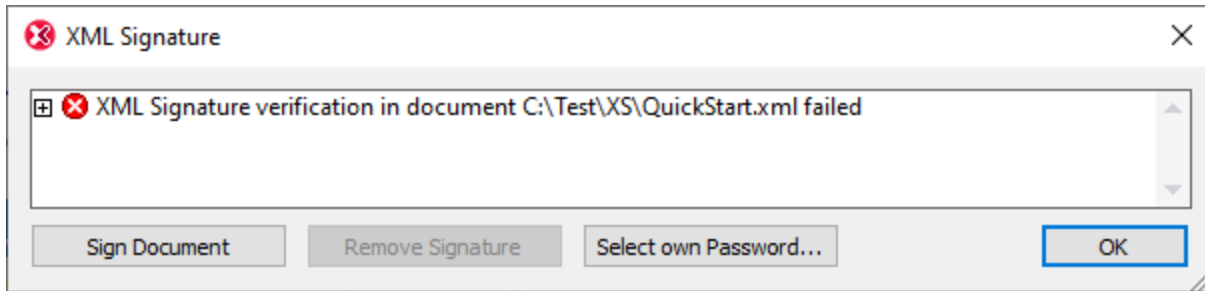

If the **Select Own Certificate** or **Select Own Password** button is present in this dialog, it means that the Authentic View has been given the option of selecting an own certificate/password. (Whether a certificate or password is to be chosen has been decided by the SPS designer at the time the signature was configured. The signature will be either certificate-based or password-based.) Clicking either of these buttons, if present in the dialog, enables the Authentic View user to browse for a certificate or to enter a password. The Authentic View user's selection is stored in memory and is valid for the current session only. If, after selecting a certificate or password, the document or application is closed, the certificate/password setting reverts to the setting originally saved with the SPS.

Verification and authentication information

If the verification process is run on a signed document, two general situations are possible. First: If the authentication information is available (in the signature or the SPS), then the verification process is executed directly and the result is displayed (*screenshot below*).

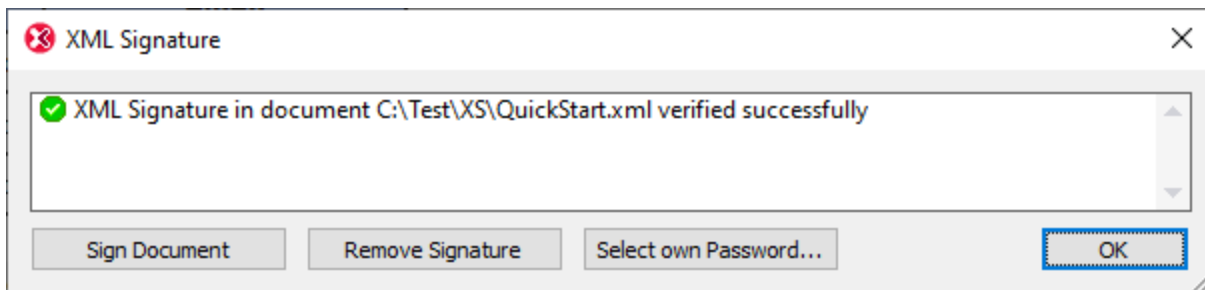

Authentication information is either the signing certificate's key information or the signing password. The SPS designer will have specified whether the certificate's key information is saved in the signature when the XML document is signed, or, in the case of a password-based signature, whether the password is saved in the SPS. In either of these cases, the authentication is available. Consequently the verification process will be run directly, without requiring any input from the Authentic View user.

The second possible general situation occurs when authentication information is not available in the signature (certificate's key information) or SPS file (password). In this situation, the Authentic View user will be asked to supply the authentication information: a password (*see screenshot below*) or the location of a certificate. If the SPS allows Authentic View to select their own password or certificate, click **Select own Password (or Certificate)** to do that.

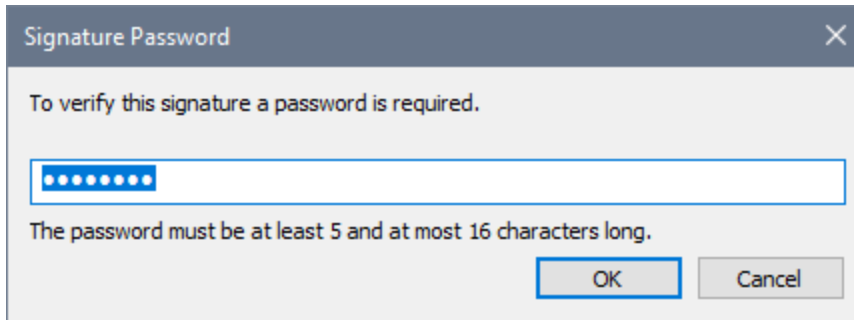

25.9.7 Define XML Entities

You can define entities for use in Authentic View, whether your document is based on a DTD or an XML Schema. Once defined, these entities are displayed in the Entities Entry Helper and in the **Insert Entity** submenu of the context menu. When you double-click on an entity in the Entities Entry Helper, that entity is inserted at the cursor insertion point.

An entity is useful if you will be using a text string, XML fragment, or some other external resource in multiple locations in your document. You define the entity, which is basically a short name that stands in for the required data, in the Define Entities dialog. After defining an entity you can use it at multiple locations in your document. This helps you save time and greatly enhances maintenance.

There are two broad types of entities you can use in your document: a **parsed entity**, which is XML data (either a text string or a fragment of an XML document), or an **unparsed entity**, which is non-XML data such as a binary file (usually a graphic, sound, or multimedia object). Each entity has a name and a value. In the case of parsed entities the entity is a placeholder for the XML data. The value of the entity is either the XML data itself or a URI that points to a `.xml` file that contains the XML data. In the case of unparsed entities, the value of the entity is a URI that points to the non-XML data file.

To define an entity:

1. Click **Authentic | Define XML Entities**. This opens the Define Entities dialog.

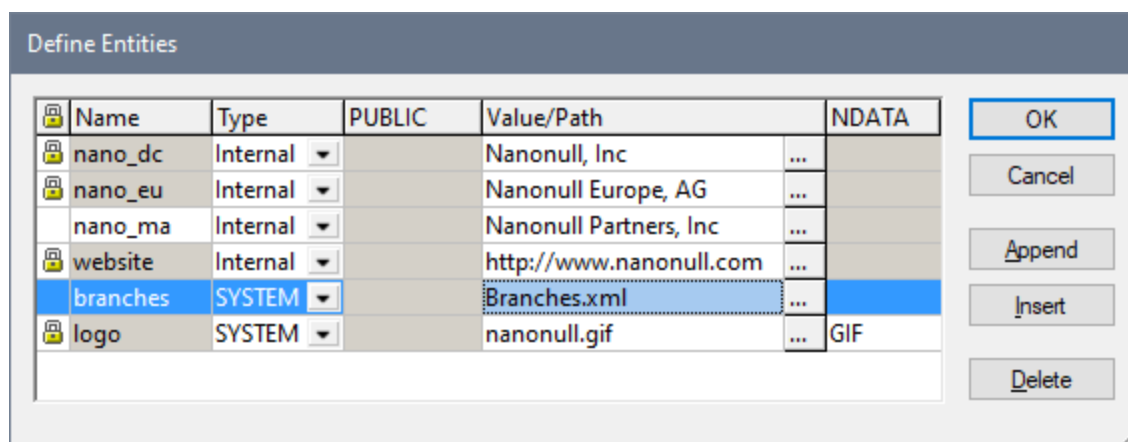

2. Enter the name of your entity in the **Name** field. This is the name that will appear in the Entities Entry Helper.
3. Enter the type of entity from the drop-down list in the **Type** field. Three types are possible. An **Internal** entity is one for which the text to be used is stored in the XML document itself. Selecting **PUBLIC** or **SYSTEM** specifies that the resource is located outside the XML file, and will be located with the use of a public identifier or a system identifier, respectively. A system identifier is a URI that gives the location of the resource. A public identifier is a location-independent identifier, which enables some processors to identify the resource. If you specify both a public and system identifier, the public identifier resolves to the system identifier, and the system identifier is used.
4. If you have selected PUBLIC as the Type, enter the public identifier of your resource in the PUBLIC field. If you have selected Internal or SYSTEM as your Type, the PUBLIC field is disabled.
5. In the **Value/Path** field, you can enter any one of the following:
 - If the entity type is Internal, enter the text string you want as the value of your entity. Do not enter quotes to delimit the entry. Any quotes that you enter will be treated as part of the text string.
 - If the entity type is SYSTEM, enter the URI of the resource or select a resource on your local network by using the **Browse** button. If the resource contains parsed data, it must be an XML file (i.e. it must have a **.xml** extension). Alternatively, the resource can be a binary file, such as a GIF file.
 - If the entity type is PUBLIC, you must additionally enter a system identifier in this field.
6. The NDATA entry tells the processor that this entity is not to be parsed but to be sent to the appropriate processor. The NDATA field should therefore be used with unparsed entities only.

Dialog features

You can append, insert, and delete entities by clicking the appropriate buttons. You can also sort entities on the alphabetical value of any column by clicking the column header; clicking once sorts in ascending order, twice in descending order. You can also resize the dialog box and the width of columns.

Once an entity is used in the XML document, it is locked and cannot be edited in the Define Entities dialog. Locked entities are indicated by a lock symbol in the first column. Locking an entity ensures that the XML document is valid with respect to entities. (The document would be invalid if an entity is referenced but not defined.)

Duplicate entities are flagged.

Limitations

- An entity contained within another entity is not resolved, either in the dialog, Authentic View, or XSLT output, and the ampersand character of such an entity is displayed in its escaped form, i.e. `&`.
- External entities are not resolved in Authentic View, except in the case where an entity is an image file and it is entered as the value of an attribute which has been defined in the schema as being of type **ENTITY** or **ENTITIES**. Such entities are resolved when the document is processed with an XSLT generated from the SPS.

25.9.8 View Markup

The **View Markup** command has a submenu with options to control markup in the Authentic XML document. These options are described below.



The **Hide Markup** command hides markup symbols in Authentic View.



The **Show Small Markup** command shows small markup symbols in Authentic View.



The **Show Large Markup** command shows large markup symbols in Authentic View.



The **Show Mixed Markup** command shows mixed markup symbols in Authentic View. The person who designs the StyleVision Power Stylesheet can specify either large markup, small markup, or no markup for individual elements/attributes in the document. The Authentic View user sees this customized markup in mixed markup viewing mode.

25.9.9 RichEdit

Hovering over the **RichEdit** command pops out a submenu containing the RichEdit markup commands (*screenshot below*). The menu commands in this submenu are enabled only in Authentic View and when the cursor is placed inside an element that has been created as a RichEdit component in the SPS design.

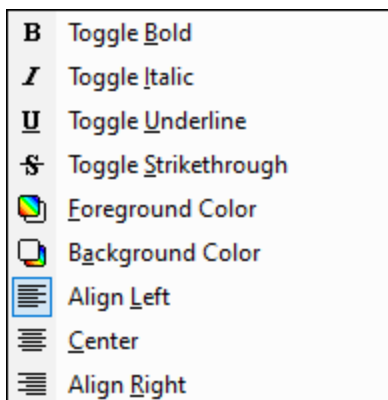

The text-styling properties of the RichEdit menu will be applied to the selected text when a RichEdit markup command is clicked. The Authentic View user can, in addition to the font and font-size specified in the Authentic toolbar, additionally specify the font-weight, font-style, font-decoration, color, background color and alignment of the selected text.

25.9.10 Append/Insert/Duplicate/Delete Row



The **Append Row** command appends a row to the current table in Authentic View.



The **Insert Row** command inserts a row into the current table in Authentic View.



The **Duplicate Row** command duplicates the current table row in Authentic View.



The **Delete Row** command deletes the current table row in Authentic View.

25.9.11 Collapse/Expand Markup

This command becomes enabled when Authentic markup has been switched on (see [View Markup](#)⁹²⁸) and a node's markup tag has been selected. Clicking the command when the node is expanded collapses the node. Clicking the command when the node is collapsed expands the node.

25.9.12 Move Row, Delete Row

The following row commands are enabled in Authentic View:

- **Move Row Up** moves the current table row up by one row in Authentic View.
- **Move Row Down** moves the current table row down by one row in Authentic View.
- **Delete Row** deletes the current row.

25.9.13 Generate HTML, RTF, PDF, Word 2007+ Document

These five commands are enabled when a PXF file is the active file. They generate output documents from the Authentic View XML document stored in the PXF file:

- **Generate an HTML Document**
- **Generate an RTF Document**
- **Generate a PDF Document**
- **Generate a Word 2007+ Document**
- **Generate a Text Document**

The commands are also available in the Portable XML Form (PXF) toolbar (*screenshot below*).



Clicking the individual command or buttons generates HTML, RTF, PDF, or DocX output, respectively.

Individual commands and buttons are enabled if the PXF file was configured to contain the XSLT stylesheet for that specific output format. For example, if the PXF file was configured to contain the XSLT stylesheets for HTML and RTF, then only the commands and toolbar buttons for HTML and RTF output will be enabled while those for Text, PDF and DocX (Word 2007+) output will be disabled.

25.9.14 Trusted Locations

The Trusted Locations command pops up the Trusted Locations dialog (*screenshot below*), in which you can specify the security settings for scripts in an SPS. When an XML file based on a script-containing SPS is switched to Authentic View, the script will be allowed to run or not depending on the settings you make in this dialog.

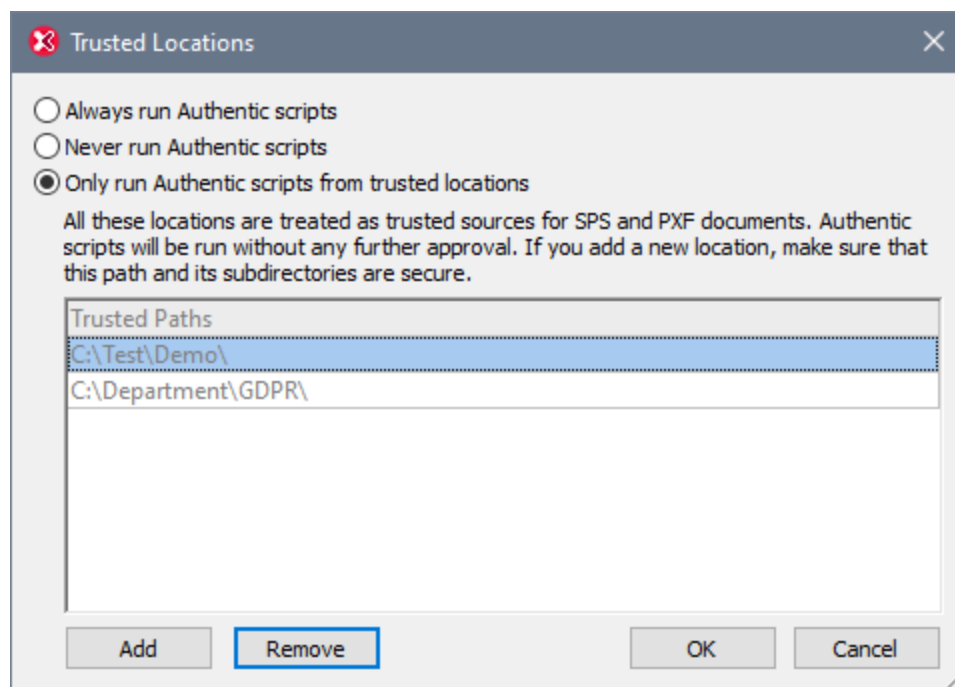

The three available options are:

- Authentic scripts are always run when a file is opened in Authentic View.
- Authentic scripts are never run when a file is opened in Authentic View.
- Only Authentic scripts in trusted locations are run. The list of trusted (folder) locations is shown in the bottom pane. Use the **Add** button to browse for a folder and add it to the list. To remove an entry from the list, select an entry in the Trusted Locations list and click **Remove**.

25.10 DB Menu

The **DB** menu is the menu for database (DB) operations. It is shown in the screenshot below and contains the menu items listed below. Descriptions of commands in the sub-menus of the DB menu are in the sub-sections of this section.

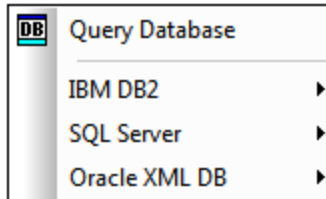

- [Query Database](#)⁹³², which enables you to query a variety of databases.
- [IBM DB2](#)⁹⁴⁸, which contains commands that provide support for IBM DB2-specific functionality.
- [SQL Server](#)⁹⁵³, which contains commands for managing SQL Server databases.

The operations described in this section require a connection to a database (for instructions, see [Connecting to a Database](#)⁶⁰⁹).

25.10.1 Query Database

The **Query Database** command opens the Database Query window (*screenshot below*). Once the Query Window is open, its display can be toggled on and off by clicking either the **DB | Query Database** command or the Query Database toolbar icon .

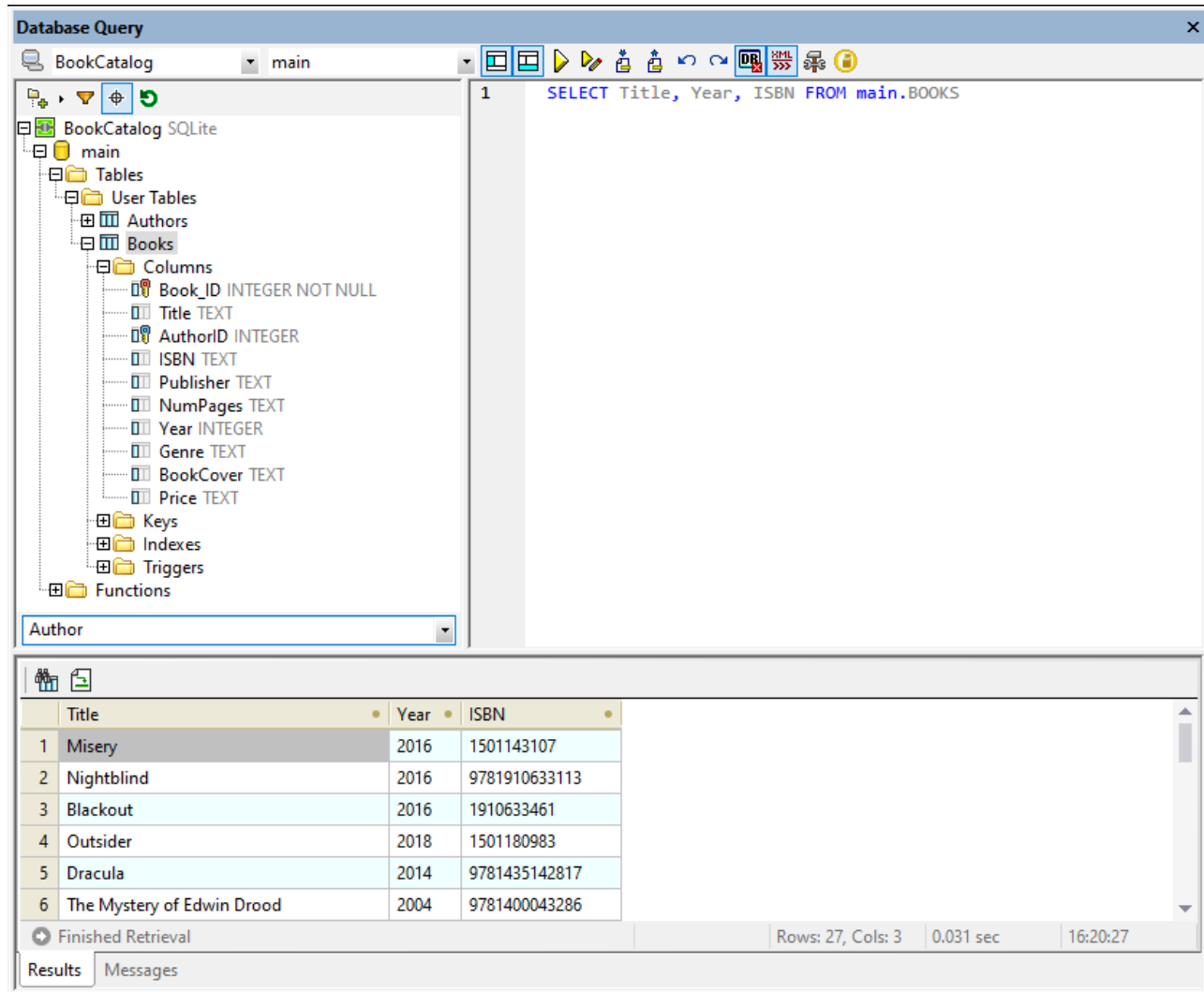

Overview of the Database Query window

The Database Query window consists of three parts:

- A [Browser pane](#)⁹³⁷ at top left, which displays connection info and database tables.
- A [Query pane](#)⁹⁴¹ at top right, in which the query is entered.
- A tabbed [Results/Messages pane](#)⁹⁴⁵. The Results pane displays the query results in what we call the Result Grid. The Messages pane displays messages about the query execution, including warnings and errors.

The Database Query window has a toolbar at the top. At this point, take note of the two toolbar icons below. The other toolbar icons are described in the section, [Query Pane: Description and Features](#)⁹⁴¹.

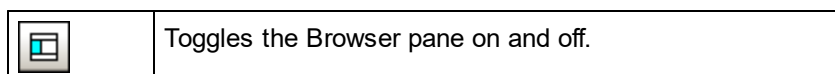

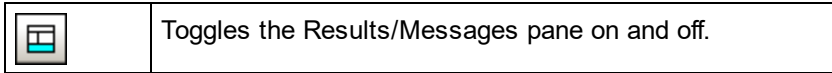

Overview of the Query Database mechanism

The Query Database mechanism is as follows. It is described in detail in the sub-sections of this section

1. A [connection to the database is established](#)⁹³⁴ via the Database Query window. Supported databases include: MS Access 2000 and 2003; Microsoft SQL Server; Oracle; MySQL; Sybase; and IBM DB2.
2. The connected database or parts of it are displayed in the [Browser pane](#)⁹³⁷, which can be configured to suit viewing requirements.
3. A [query](#)⁹⁴⁴ written in a syntax appropriate to the database to be queried is entered in the [Query pane](#)⁹⁴⁴, and the query is executed.
4. The [results of the query](#)⁹⁴⁵ can be viewed through various filters, edited, and saved back to the DB.

25.10.1.1 Data Sources

In order to query a database, you have to first connect to the required database This section describes how to:

- Connect to a database, and
- Select the required data source and root object from among multiple existing connections.

Connect to a database

Click the **Query Database** command to start building a connection. The Connect to a Data Source dialog (*screenshot below*) appears. Select the DB type that you want and follow the wizard's instructions.

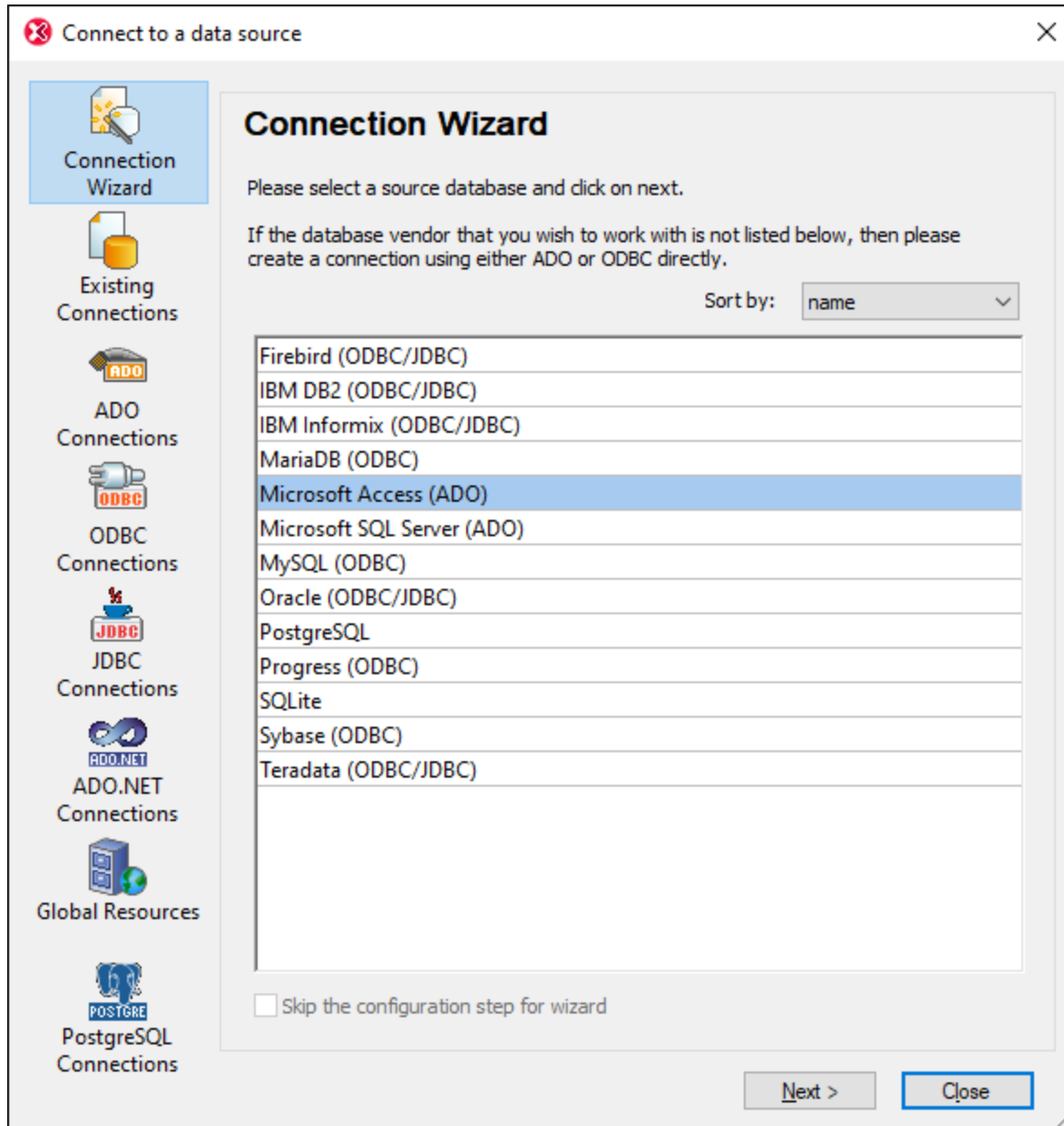

If the DB connection is successful, then the Database Query window appears. To make connections to other DBs from this point onwards, click the **Quick Connect** icon  in the Database Query window. How to connect to a database via the Quick Connect dialog is described in the section [Connecting to a Data Source](#) ⁶⁰⁹.

The table below lists all the supported databases. If your Altova application is a 64-bit version, ensure that you have access to the 64-bit database drivers needed for the specific database you are connecting to.

| Database | Notes |
|--|---|
| Firebird 2.x, 3.x, 4.x | |
| IBM DB2 8.x, 9.x, 10.x, 11.x | |
| IBM Db2 for i 6.x, 7.4, 7.5 | Logical files are supported and shown as views. |
| IBM Informix 11.70 and later | |
| MariaDB 10 and later | MariaDB supports native connections. No separate drivers are required. |
| Microsoft Access 2003 and later | At the time of writing (early September 2019), there is no Microsoft Access Runtime available for Access 2019. You can connect to an Access 2019 database from Altova products only if Microsoft Access 2016 Runtime is installed and only if the database does not use the "Large Number" data type. |
| Microsoft Azure SQL Database | SQL Server 2016 codebase |
| Microsoft SQL Server 2005 and later
Microsoft SQL Server on Linux | |
| MySQL 5 and later | MySQL 5.7 and later supports native connections. No separate drivers are required. |
| Oracle 9i and later | |
| PostgreSQL 8 and later | PostgreSQL connections are supported both as native connections and driver-based connections through interfaces (drivers) such as ODBC or JDBC. Native connections do not require any drivers. |
| Progress OpenEdge 11.6 | |
| SQLite 3.x | SQLite connections are supported as native, direct connections to the SQLite database file. No separate drivers are required.

In Authentic view, data coming from a SQLite database is not editable. When you attempt to save SQLite data from the Authentic view, a message box will inform you of this known limitation. |
| Sybase ASE 15, 16 | |
| Teradata 16 | |

Select the required data source

All the existing connections and the root objects of each are listed, respectively, in two combo boxes in the toolbar of the Database Query window (*screenshot below*).

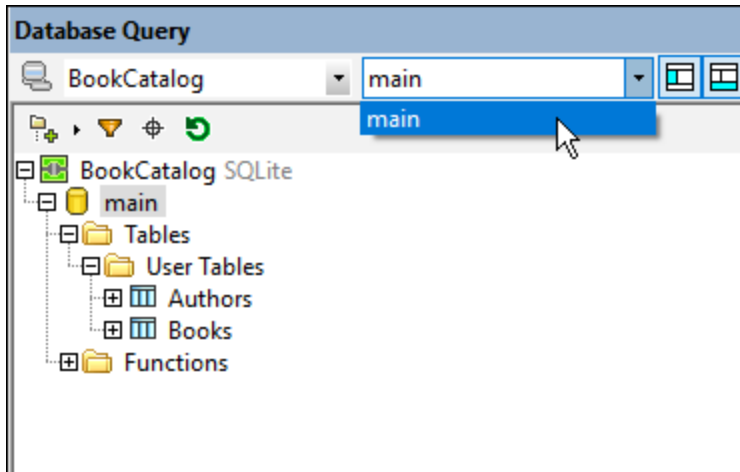

In the screenshot above, a connection has been made to the database named `BookCatalog`. This DB has only one available root object— named `main`— and it has been selected. The database and the root object are then displayed in the Browser pane.

25.10.1.2 Browser Pane: Viewing the DB Objects

The Browser pane provides an overview of objects in the selected database. This overview includes database constraint information, such as whether a column is a primary or foreign key. In IBM DB2 version 9 databases, the Browser additionally shows registered XML schemas in a separate folder.

This section describes the following:

- The [layouts](#)⁹³⁷ available in the Browser pane.
- [How to filter](#)⁹³⁹ database objects.
- [How to find](#)⁹⁴⁰ database objects.

Browser pane layouts

The default Folders layout displays database objects hierarchically. Depending on the selected object, different context menu options are available when you right-click an item.

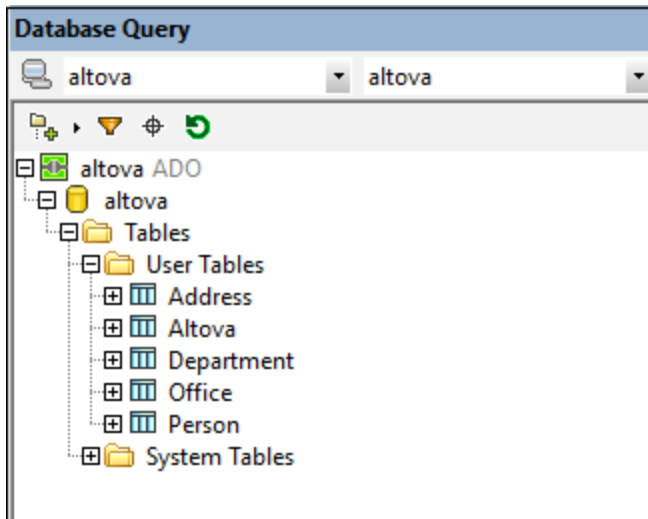

To select a layout for the Browser, click the Layout icon in the toolbar of the Browser pane and select the layout from the drop-down list (screenshot below). Note that the icon changes with the selected layout.

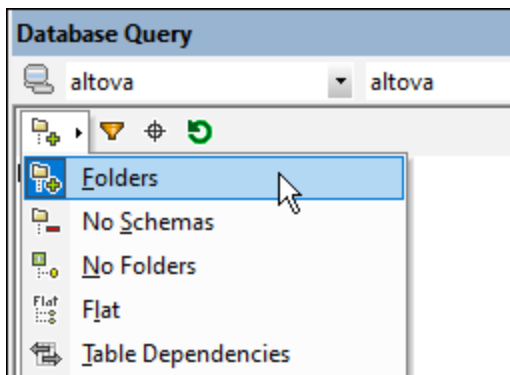

The available layouts are:

- *Folders*: Organizes database objects into folders based on object type in a hierarchical tree, this is the default setting.
- *No Schemas*: Similar to the Folders layout, except that there are no database schema folders; tables are therefore not categorized by database schema.
- *No Folders*: Displays database objects in a hierarchy without using folders.
- *Flat*: Divides database objects by type in the first hierarchical level. For example, instead of columns being contained in the corresponding table, all columns are displayed in a separate Columns folder.
- *Table Dependencies*: Categorizes tables according to their relationships with other tables. There are categories for tables with foreign keys, tables referenced by foreign keys and tables that have no relationships to other tables.

To sort tables into User and System tables, switch to Folders, No Schemas or Flat layout, then right-click the Tables folder and select **Sort into User and System Tables**. The tables are sorted alphabetically in the User Tables and System Tables folders.

Filter database objects

In the Browser pane (in all layouts except No Folders and Table Dependencies), tables, views, function, filters and other DB-specific objects can be filtered on their names. Objects are filtered as you type in the characters, and filtering is case-insensitive by default.

To filter objects in the Browser, do the following:

1. Click the **Filter Folder Contents** icon in the toolbar of the Browser pane. Filter icons appear next to the top-level folders, such as Tables and Functions as in the screenshot below.

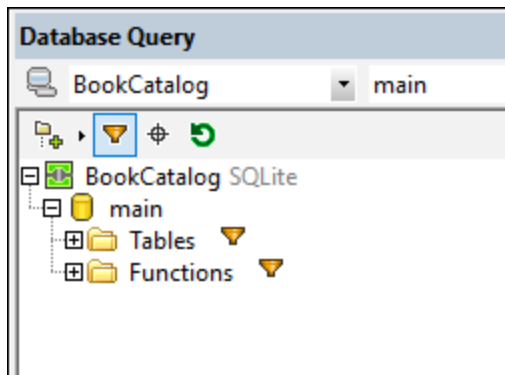

2. Click the filter icon next to the folder you want to filter, and select the filtering option from the popup menu, for example, *Contains*.

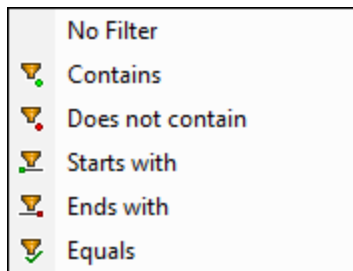

3. In the entry field that appears, enter the filter string. In the screenshot below, the filter string on the *Tables* and *Functions* folders are *Auth* and *STR*, respectively, and they filter the contents of the two folders to tables and functions that match the respective filter.

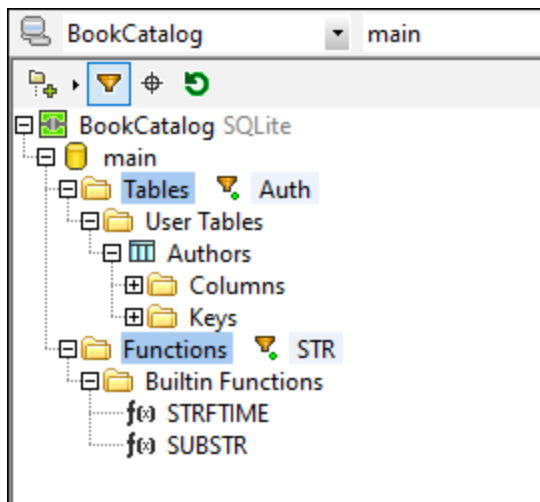

Find database objects

To find a specific database item by its name, you can use the Browser pane's Object Locator. This works as follows:

1. In the toolbar of the Browser pane, click the Object Locator icon. A drop-down list appears at the bottom of the Browser.
2. Enter the search string in the entry field of this list. In the screenshot below, we have entered `author`. Clicking the drop-down arrow displays all objects that contain this string.

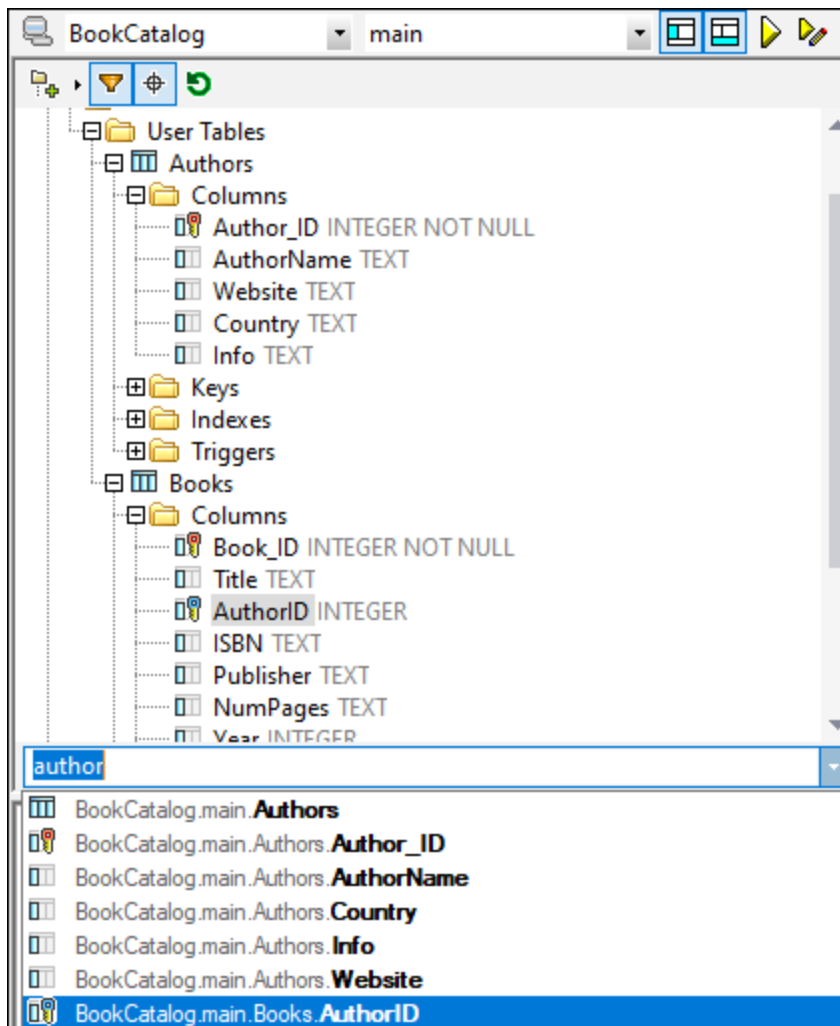

3. Click the object in the list to highlight it in the Browser.











25.10.1.3 Query Pane: Description and Features

The Query pane is an intelligent SQL editor for entering queries to the selected database. After entering the query, clicking the Execute command of the Database Query window executes the query and displays the result and execution messages in the [Results/Messages pane](#)⁹⁴⁵. How to work with queries is described in the next section, [Query Pane: Working with Queries](#)⁹⁴⁴. In this section, we describe the main features of the Query pane:

- SQL Editor icons in the Database Query toolbar
- SQL Editor options
- Definition of regions in an SQL script
- Insertion of comments in an SQL script
- Use of bookmarks

SQL Editor icons in the Database Query toolbar

The following icons in the toolbar of the Database Query window are used when working with the SQL Editor:

| | | |
|---|---------------------------------------|---|
|  | Execute | Executes currently selected SQL statement. If script contains multiple statements and none is selected, then all are executed. |
|  | Execute with Data Editing | Same as for Execute command, except that results (in Results tab) are editable. |
|  | Import SQL File | Opens an SQL file in the SQL Editor. |
|  | Export SQL File | Saves SQL queries to an SQL file. |
|  | Undo | Undoes an unlimited number of edits in SQL Editor. |
|  | Redo | Redoes an unlimited number of edits in SQL Editor. |
|  | Hide DB Query on XML Open | Sets whether the DB Query window should be hidden when an XML document is opened for editing. |
|  | Auto-Commit on XML Save | When an edited XML document is saved in XMLSpy, changes are committed to the DB if this toggle is on. Otherwise, changes have to be explicitly committed in the Results Pane. |
|  | Options | Open the Options dialog of SQL Editor. |
|  | Open SQL Script in DatabaseSpy | Opens the SQL script in Altova's DatabaseSpy product. |

Options

Clicking the **Options** icon in the Database Query toolbar pops up the Options dialog (*screenshot below*). A page of settings can be selected in the left-hand pane, and the options on that page can be selected. Click the **Reset to Page Defaults** button to reset the options on that page to their original settings.

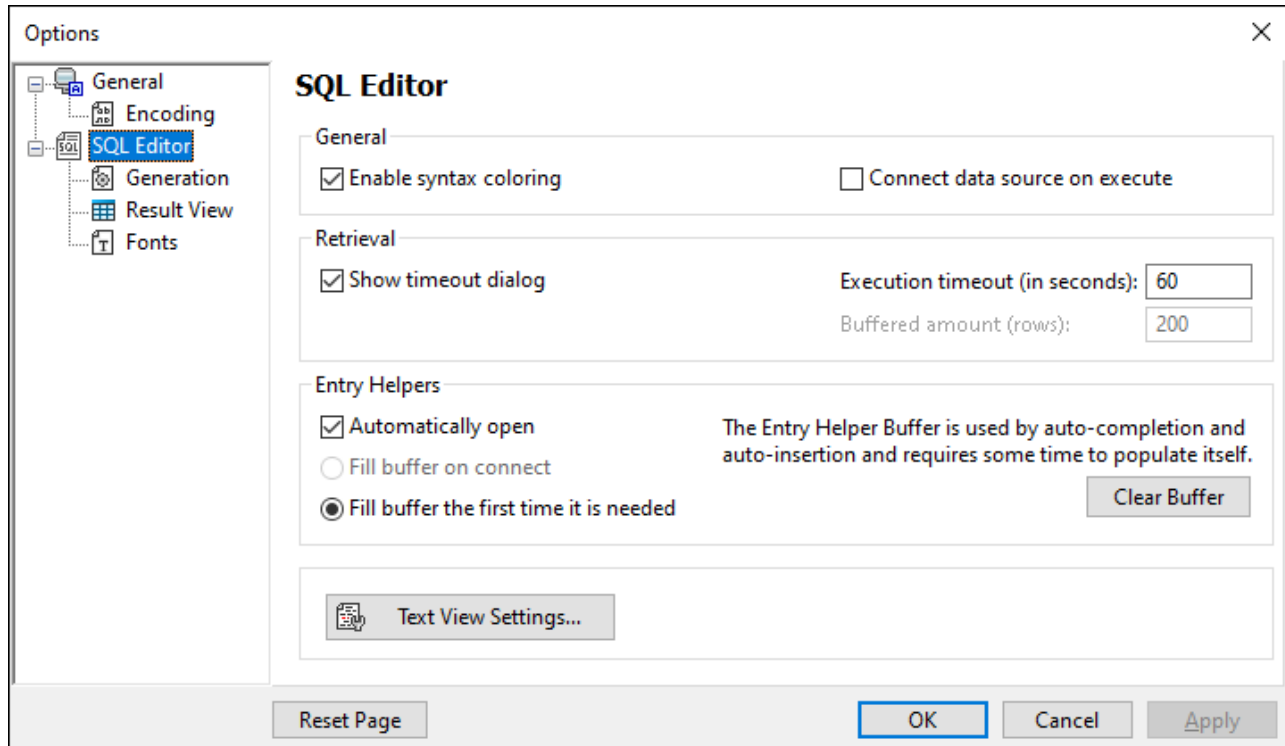

The key settings are as follows:

- **General | Encoding:** Options for setting the encoding of new SQL files, of existing SQL files for which the encoding cannot be detected, and for setting the Byte Order Mark (BOM). (If the encoding of existing SQL files can be detected, the files are opened and saved without changing the encoding.)
- **SQL Editor:** Options for toggling syntax coloring and data source connections on execution on/off. A timeout can be set for query execution, and a dialog to change the timeout can also be shown if the specified time is exceeded. Entry helpers refer to the entry helpers that appear as part of the auto-completion feature. When you type in an SQL statement, the editor displays a list of context-sensitive auto-completion suggestions. These suggestions can be set to appear automatically. If the automatic display is switched off, then you can ask for an auto-completion suggestion in SQL Editor by pressing **Ctrl+Spacebar**. The buffer for the entry helper information can be filled either on connection to the data source or the first time it is needed. The [Text View settings](#)⁹⁹⁵ button opens the Text View options window of XMLSpy.
- **SQL Editor | SQL Generation:** The application generates SQL statements when you drag objects from the Browser pane into the Query pane. Options for SQL statement generation can be set in the SQL generation tab. Use the *Database* pane to select a database kind and set the statement generation options individually for the different database kinds you are working with. Activating the *Apply to all databases* check box sets the options that are currently selected for all databases. Options include appending semi-colons to statements and surrounding identifiers with escape characters. When the *Append semicolons to statement end* check box is activated, a semicolon is appended when you generate an SQL statement in the SQL Editor. Note that editing of data in Oracle databases and IBM iSeries and DB2 databases via a JDBC connection is possible only if this check box is unchecked.
- **SQL Editor | Result View:** Options to configure the Result tab.
- **SQL Editor | Fonts:** Options for setting the font style of the text in the Text Editor and in the Result View.

Define regions in an SQL script

Regions are sections in SQL scripts that are marked and declared to be a unit. Regions can be collapsed and expanded to hide or display parts of the script. It is also possible to nest regions within other regions. Regions are delimited by `--region` and `--endregion` comments, respectively, before and after the region. Regions can optionally be given a name, which is entered after the `-- region` delimiter (see screenshot below).



To insert a region, select the statement/s to be made into a region, right-click, and select **Insert Region**. The expandable/collapsible region is created. Add a name if you wish. In the screenshot above, also notice the line-numbering. To remove a region, delete the `--region` and `--endregion` delimiters.

Insert comments in an SQL script

Text in an SQL script can be commented out. These portions of the script are skipped when the script is executed.

- To comment out a block, mark the block, right-click, and select **Insert/Remove Block Comment**. To remove the block comment, mark the comment, right-click and select **Insert/Remove Block Comment**.
- To comment out a line or part of a line, place the cursor at the point where the line comment should start, right-click, and select **Insert/Remove Line Comment**. To remove the line comment, mark the comment, right-click and select **Insert/Remove Line Comment**.

Bookmarks

Bookmarks can be inserted at specific lines, and you can then navigate through the bookmarks in the document. To insert a bookmark, place the cursor in the line to be bookmarked, right-click, and select **Insert/Remove Bookmark**. To go to the next or previous bookmark, right-click, and select **Go to Next Bookmark** or **Go to Previous Bookmark**, respectively. To remove a bookmark, place the cursor in the line for which the bookmark is to be removed, right-click, and select **Insert/Remove Bookmark**. To remove all bookmarks, right-click, and select **Remove All Bookmarks**.

25.10.1.4 Query Pane: Working with Queries

After connecting to a database, an SQL script can be entered in the SQL Editor and executed. This section describes:

- How an SQL script is entered in the SQL Editor.
- How the script is executed in the Database Query window.

The following icons are referred to in this section:



Execute Query Executes currently selected SQL statement. If script contains multiple statements and none is selected, then all are executed.



Execute for Data Editing Same as for Execute command, except that results (in Results tab) are editable.



Import SQL File Opens an SQL file in the SQL Editor.

Create SQL statements and scripts The following GUI methods can be used to create SQL statements or scripts:

- *Drag and drop:* Drag an object from the Browser pane into the SQL Editor. An SQL statement is generated to query the database for that object.
- *Context menu:* Right-click an object in the Browser pane and select **Show in SQL Editor | Select**.
- *Manual entry:* Type SQL statements directly in SQL Editor. The Auto-completion feature can help with editing.
- *Import an SQL script:* Click the **Import SQL File** icon in the toolbar of the Database Query window.

Execute SQL statements

If the SQL script in the SQL Editor has more than one SQL statement, select the statement to execute and click either the **Execute** icon or **Execute with Data Editing** icon in the toolbar of the Database Query window. If no statement in the SQL script is selected, then all the statements in the script are executed. The database data is retrieved and displayed as a grid in the [Results tab](#)⁹⁴⁵. If **Execute with Data Editing** was selected, then the retrieved data in the Result Grid [can be edited](#)⁹⁴⁵. Messages about the execution are displayed in the [Messages tab](#)⁹⁴⁵.

25.10.1.5 Results and Messages



The Results/Messages pane has two tabs:













- The [Results tab](#)⁹⁴⁵ shows the data that is retrieved by the query.
- The [Messages tab](#)⁹⁴⁷ shows messages about the query execution.

Results tab

The data retrieved by the query is displayed in the form of a grid in the Results tab (*screenshot below*).

| | Author_ID | AuthorName | Website | Country |
|---|-----------|-----------------|----------------------------|---------|
| 1 | 1 | Stephen King | www.stephenking.com | US |
| 2 | 2 | Ragnar Jonasson | www.ragnarjonasson.com | Iceland |
| 3 | 3 | Bram Stoker | www.bramstoker.org | UK |
| 4 | 4 | Charles Dickens | www.charlesdickensinfo.com | UK |

If the query results contain XML data, as, for example, would be the case with IBM DB2 databases, then the XML documents in the Results tab are indicated with the XML icon  (see *screenshot below*). If the **Execute for Data Editing** toolbar command was used (instead of the **Execute Query** toolbar command), then XML documents are shown with the **Editable XML** icon .

| | CID | INFO | HISTORY |
|---|------|--|--|
| 1 | 1000 |  <?xml version="1.0" encoding="UTF-8" ?><n1:customer... |  [NULL] |
| 2 | 1001 |  <?xml version="1.0" encoding="UTF-8" ?><customerinfo ... |  [NULL] |
| 3 | 1002 |  <?xml version="1.0" encoding="UTF-8" ?><customerinfo ... |  [NULL] |
| 4 | 1003 |  <?xml version="1.0" encoding="UTF-8" ?><customerinfo ... |  [NULL] |
| 5 | 1004 |  <?xml version="1.0" encoding="UTF-8" ?><customerinfo ... |  [NULL] |
| 6 | 1005 |  <?xml version="1.0" encoding="UTF-8" ?><customerinfo ... |  [NULL] |

Finished Retrieval Rows: 6, Cols: 3 0.110 sec 15:42:49



Results Messages

The following operations can be carried out in the Results tab, via the context menu that pops up when you right-click in the appropriate location in the Results tab:

- **Sorting on a column:** Right-click anywhere in the column on which the records are to be sorted, then select **Sorting | Ascending/Descending/Restore Default**.
- **Copying to the clipboard:** This consists of two steps: (i) selecting the data range; and (ii) copying the selection. Data can be selected in several ways: (i) by clicking a column header or row number to select the column or row, respectively; (ii) selecting individual cells (use the **Shift** and/or **Ctrl** keys to select multiple cells); (iii) right-clicking a cell, and selecting **Selection | Row/Column/All**. After making the selection, right-click, and select **Copy Selected Cells**. This copies the selection to the clipboard, from where it can be pasted into another application.
- **Appending a new row:** If the query was executed for editing, right-click anywhere in the Results pane to access the **Append row** command.
- **Deleting a row:** If the query was executed for editing, right-click anywhere in a row to access the **Delete row** command.
- **Editing records:** If the query was executed for editing, individual fields can be edited. To commit changes, click the **Commit** button in the toolbar of the Results tab.
- **Editing XML records:** This feature is supported for IBM DB2, SQLServer, PostgreSQL (8.3 and higher), and Oracle (9 and higher) databases, and only for those DB tables that have a primary key. If the query was executed for editing and an editable field is an XML field, clicking the Editable XML icon  in the

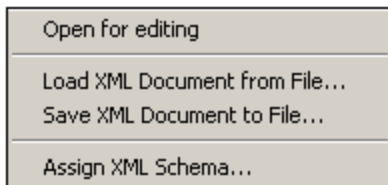





Result Grid opens the Edit XML menu (*screenshot below*). An XML field can also be opened for data editing by right-clicking the XML field in the Folders pane and selecting the command **Edit Data**.



The **Open for Editing** command opens the XML document in an XMLSpy window, and the **Editable XML** icon changes to , in which the three dots are red. When this document is saved and if the **Auto-Commit XML Changes** icon  in the Query Database toolbar was selected when the document was opened, the changes to the XML document are committed automatically to the database. Otherwise, saved changes will have to be committed using the **Commit** button of the Results pane. (Note that to toggle between the XML document window and the Database Query window, you must click the **DB | Query Database** command.) The **Load XML Document from File** command loads an external XML document to the selected field in the database. The Save XML Document to File saves the XML document in the selected database field to a file location you choose. The Assign XML Schema command pops up the [Choose XML Schema dialog](#) ⁹⁵², in which you can select an XML Schema to assign to the XML document. This assignment is saved to the database. XML Schema assignment is explained in more detail in the section, [IBM DB2 | Assign XML Schema](#) ⁹⁵².

- *Set NULL, Set default, Undo changes for this cell*: If the query was executed for editing, right-clicking in a cell provides access to commands that enable you to set a NULL value or, if defined, a column default value for that cell. Changes made to a cell can be undone with the **Undo changes for this cell** command; the current edited value is replaced by the value currently in the DB.

The Results tab has the following toolbar icons:

| | | |
|---|------------------------------------|--|
|  | Go to Statement | Highlights the statement in the SQL Editor that produced the current result. |
|  | Find | Finds text in the Results pane. XML document content is also searched. |
|  | Add New Line | Adds a new row to the Result Grid. |
|  | Delete Row | Deletes the current row in the Result Grid. |
|  | Undo Changes to Result Grid | Undoes all changes to the Result Grid. |
|  | Commit | Commits changes made in the Result Grid to the database. |

Messages tab

The Messages tab provides information on the previously executed SQL statement and reports errors or warning messages.

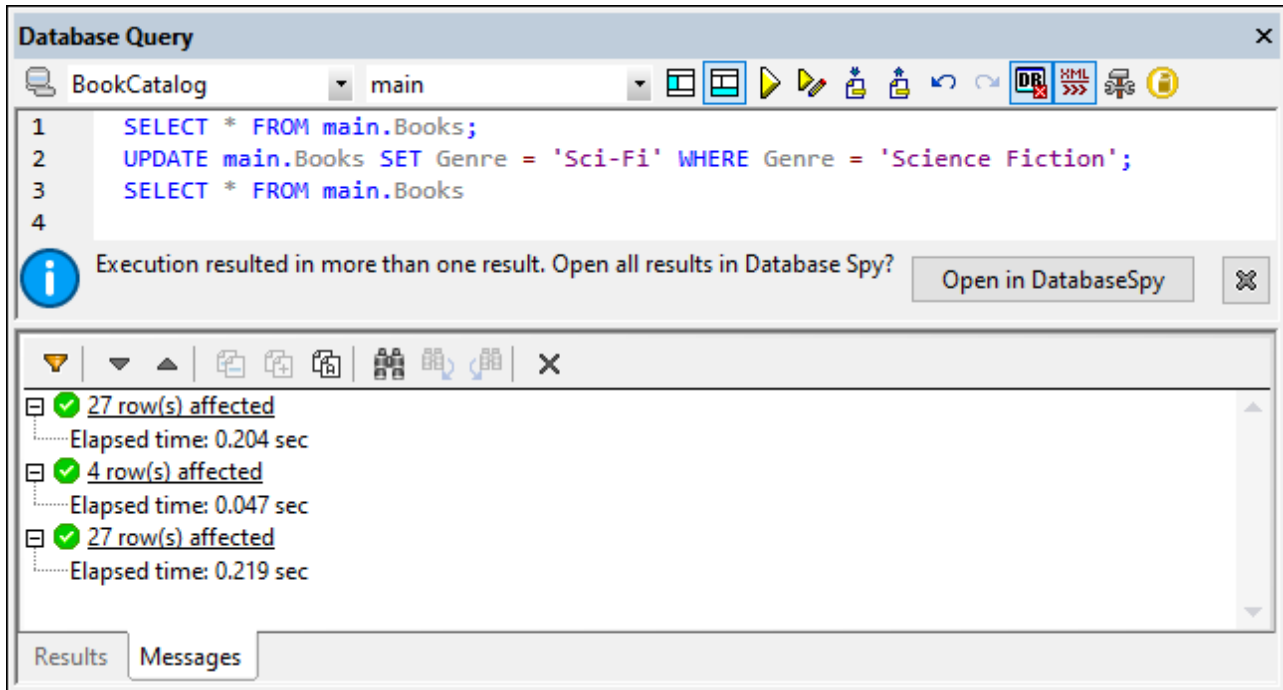

The toolbar of the Messages tab contains icons that enable you to customize the view, navigate it, and copy messages to the clipboard. The **Filter** icon enables the display of particular types of messages to be toggled on or off. The **Next** and **Previous** icons move the selection down and up the list, respectively. Messages can also be copied with or without their child components to the clipboard, enabling them to be pasted in documents. The Find function enables you to specify a search term and then search up or down the listing for this term. Finally, the **Clear** icon clears the contents of the Messages pane.

Note: These toolbar icon commands are also available as context menu commands.

25.10.2 IBM DB2

The **IBM DB2** menu item rolls out a submenu containing commands (i) to register and unregister schemas with an IBM DB2 database ([Manage XML Schemas](#)⁹⁴⁹), and (ii) to assign schemas for XML file validation ([Assign XML Schema](#)⁹⁵²).

Both these mechanisms require that you connect to the required IBM DB2 database. For a connection example, see [Example: IBM DB2 \(ODBC\)](#)⁶⁴⁷. In this section the focus is on how to manage schemas in an IBM DB2 database and how to assign XML Schemas to a DB XML file.

Note: The Result Grid of the [Database Query window](#)⁹³² provides important functionality for working with XML files in IBM DB2 databases. This functionality includes the ability to open files for editing, loading XML files into DB cells as XML files, saving these DB XML files externally, and assigning XML Schemas to DB XML files.

25.10.2.1 Manage XML Schemas

The **Manage XML Schemas** feature enables schemas to be added to and dropped from individual database schemas in an IBM DB2 database. To manage schemas, you have to do the following:

- Connect to the IBM DB2 database
- Select the database schema for which XML Schemas need to be added or dropped
- Carry out the schema management actions.

These steps are described in detail below.

Connecting to the IBM DB2 database

Clicking the **Manage XML Schemas** command pops up the XML Schema Management for Databases dialog (*screenshot below*).

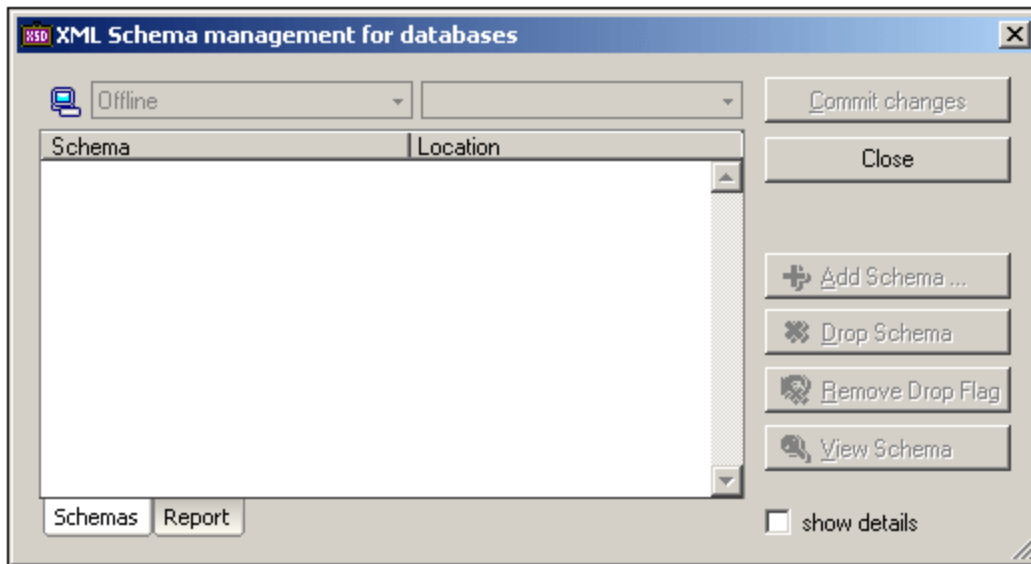

The first thing to do if there is no connection to the required database is to connect to it. If a connection already exists, it appears in the Database combo box. To start the connection process, click the Quick Connect icon  in the dialog. This pops up the Quick Connect dialog, through which you can make the connection to the database (for instructions, see [Connecting to a Database](#)⁶⁰⁹).

Displaying the list of XML Schemas

After the connection to the IBM DB2 database has been established, the database is listed in the combo box at left (*see screenshot below*). If more than one connection is currently open, you can select the required database in this combo box. In the screenshot below, the StyleVision DB database is selected.

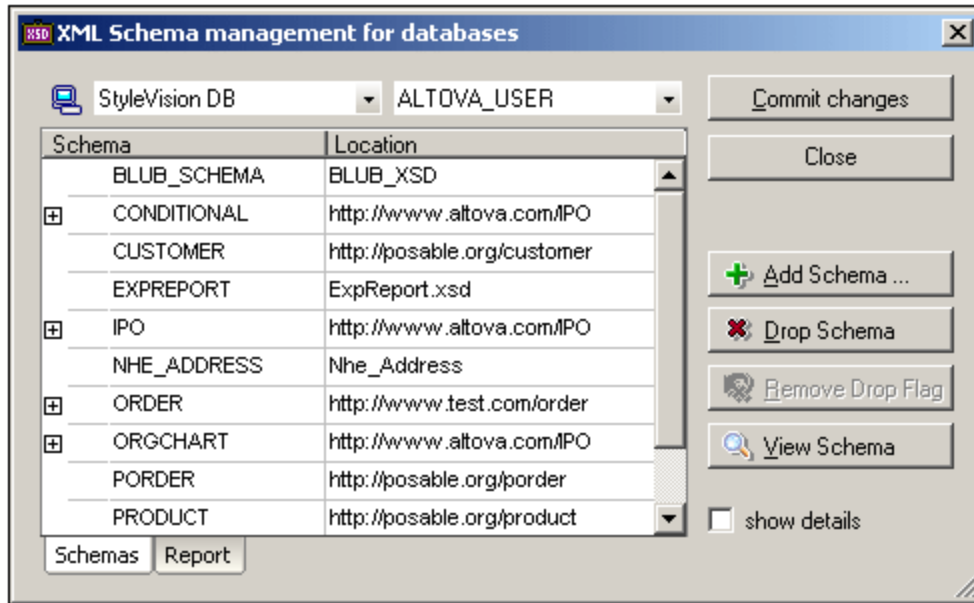

The combo box at right lists all the database schemas of the currently selected IBM DB2 database. When a database schema is selected in this combo box, all the XML Schemas registered for the selected database schema are displayed in the main pane. In the screenshot above, all the XML Schemas registered with the `Altova_User` database schema are listed, together with their locations. Checking the Show Details check box causes additional information columns to be displayed in the main pane.

Managing the XML Schemas

The list of schemas in the main pane represents the schemas registered for the selected database schema. After the list of XML Schemas is displayed, you can add schemas to the list or drop (delete) schemas from the list.

To add a schema, click the **Add** button, browse for the required schema file, and select it. The selected schema file is added to the list in the main pane. Clicking the **Commit Changes** button registers the newly added schema with the database schema.

To drop a schema, select the schema in the main pane and click the **Drop Schema** button. A Drop Flag is assigned to the schema, indicating that it is scheduled for dropping when changes are next committed. The Drop Flag can be removed by selecting the flagged schema and clicking the **Remove Drop Flag** button. When the **Commit Changes** button is clicked, all schemas that have been flagged for dropping will be unregistered from the database schema.

Clicking the View Schema button opens the schema in XMLSpy. To close the XML Schema Management dialog, click the **Close** button.

Reports

When the **Commit Changes** button is clicked, the database is modified according to the changes you have made. A report of the Commit action is displayed in the Report pane (*screenshot below*), enabling you to evaluate the success of the action and to debug possible errors. Each subsequent report is displayed below the previous report.

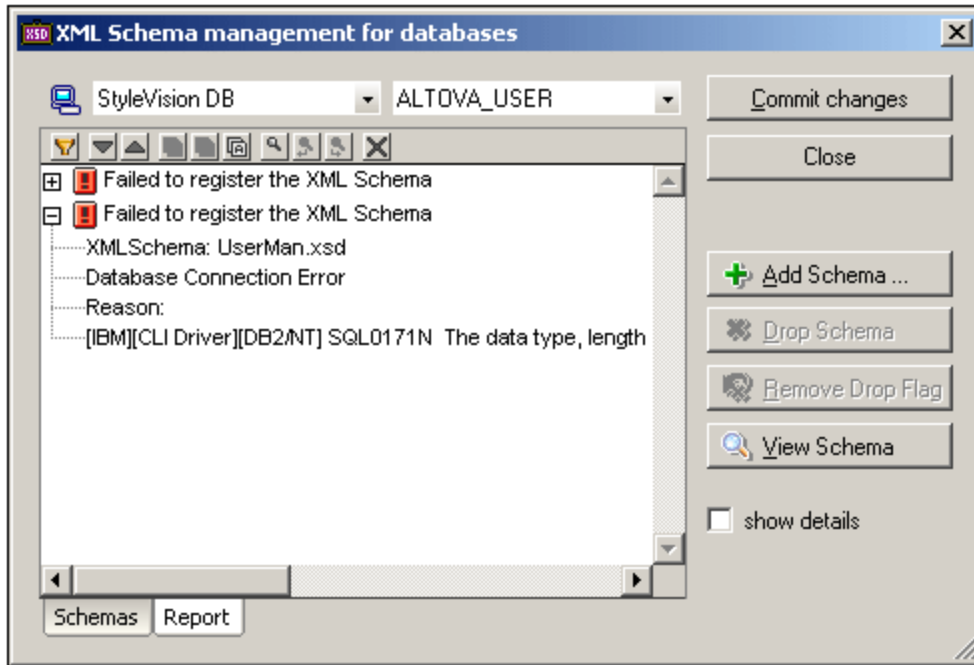

The report pane has a toolbar containing icons that enable you to customize the display of the report listing, navigate the listing, copy report messages, search for text, and clear the pane (see screenshot below).

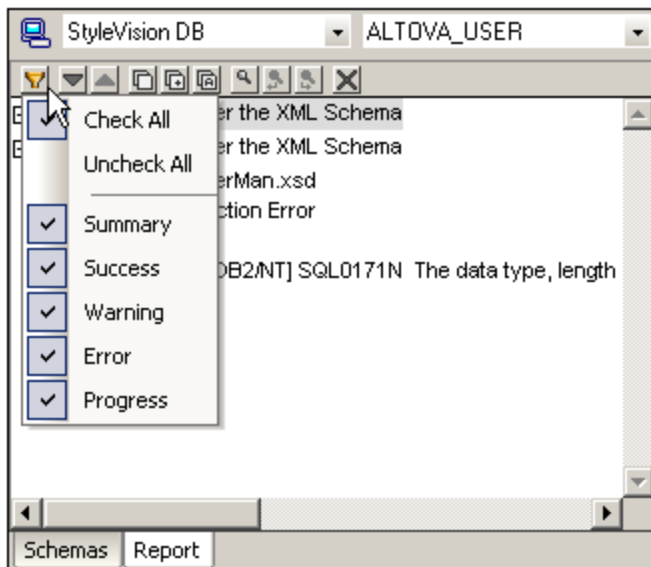

The **Filter** icon enables the display of particular types of messages to be toggled on or off. The **Next** and **Previous** icons move the selection down and up the list, respectively. Messages can also be copied with or without their child components to the clipboard, enabling them to be pasted in documents. The **Find** function enables you to specify a search term and then search up or down the listing for this term. Finally, the **Clear** icon clears the contents of the Report pane.

25.10.2.2 Assign XML Schema

The Assign XML Schema assigns a schema to an XML file opened for editing via the Result Grid of the Database Query window. After the assignment is made, the XML file can be validated against the assigned schema. The assignment is written to the DB when the XML file is saved in XMLSpy.

Opening a DB XML file for editing

In the Database Query window, when a query is addressed to an XML DB and the query is executed for data editing, the Result Grid at the bottom of the Database Query window provides access to the XML files in the database so these can be edited (see screenshot below).

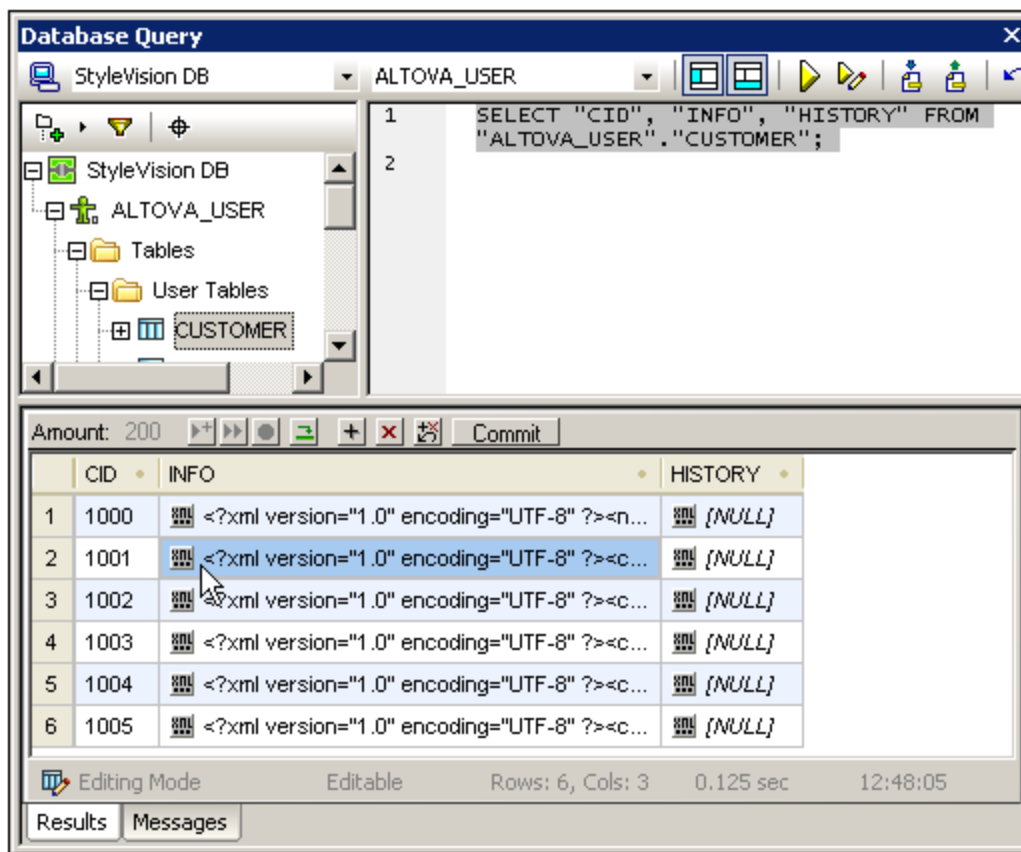

Clicking the XML icon  pops up the following menu.

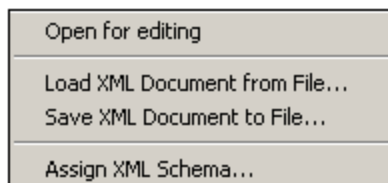

Selecting the **Open for Editing** command opens the XML document in XMLSpy, where it can be edited.

Assigning a schema to the DB XML file

It is when the DB XML file is opened for editing in XMLSpy that the **IBM DB2 | Assign XML Schema** command is enabled. With the XML document active in XMLSpy, clicking the **Assign XML Schema** command pops up the Choose XML Schema dialog (*screenshot below*).

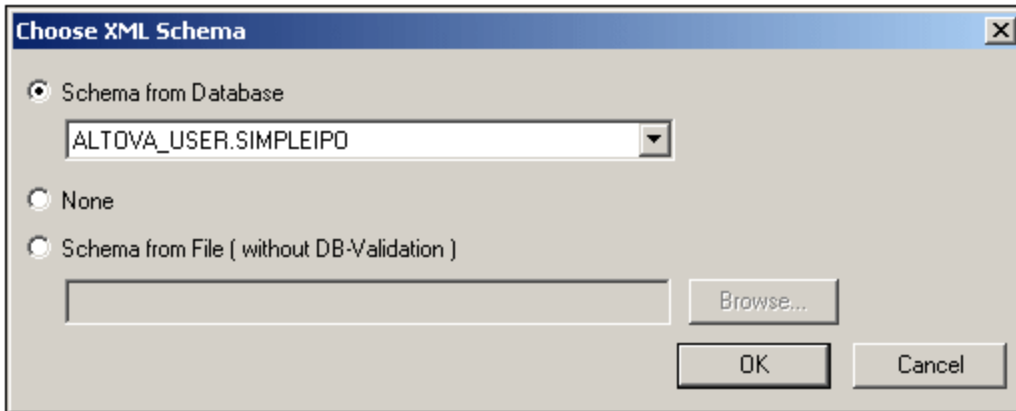

A schema can be selected from among those stored in the database (these are listed in the dropdown list of the Schema from Database combo box), or from among external files that can be browsed. Clicking **OK** assigns the schema to the XML file. Note that the assignment is not written into the XML file. When the XML file is saved in XMLSpy—and if the Auto-Commit XML changes icon  in the Query Database toolbar was selected when the document was opened—then the schema assignment is saved to the database. Note that the schema assignment is written to the database—and not to the XML file.

Note: The Edit XML menu in the Result Grid of the Database Query window also has an **Assign XML Schema** command (*see screenshot below*), which also assigns a schema to the DB XML file.

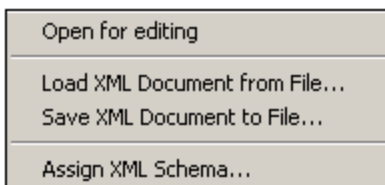

The difference between the two Assign XML Schema commands is that the command in the **DB | IBM DB2** menu enables you to assign an XML Schema while you are editing the XML file thereby allowing you to change schema assignments while editing the XML document and to validate the XML document immediately.

25.10.3 SQL Server

The **SQL Server** menu item rolls out a submenu containing the Manage XML Schemas command.

25.10.3.1 Manage XML Schemas

XML Schema management for databases enables you to add and delete XML Schemas from the schema repository of an XML database. After connecting to the database, XMLSpy provides the XML Schema Management for Databases dialog, in which XML Schemas can be managed.

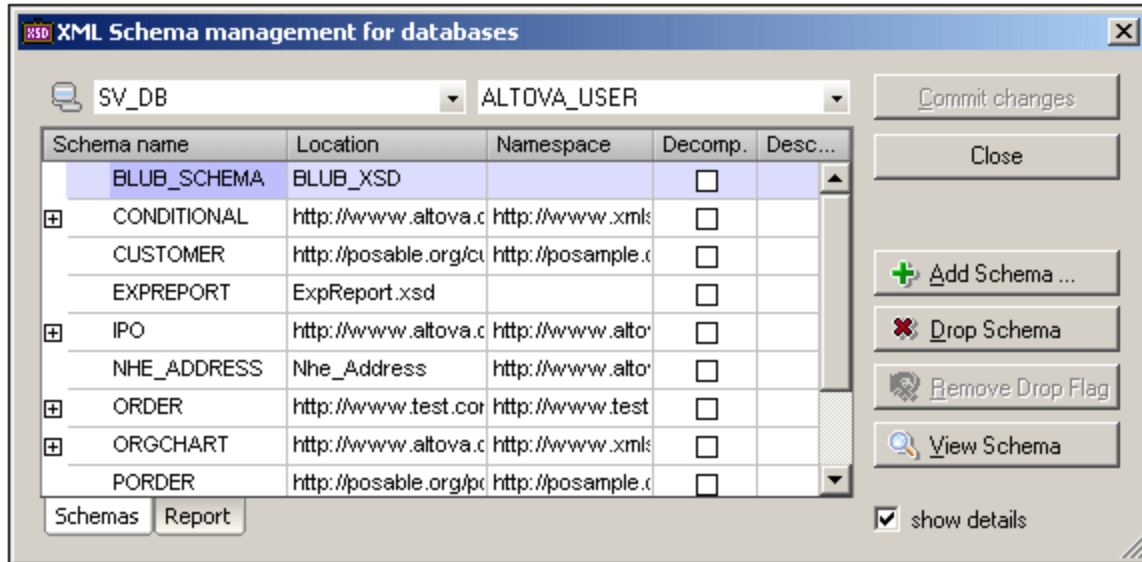

The dialog box provides a Quick Connect  icon which calls the [Quick Connect wizard](#) ⁶¹⁰ to connect to a data source. If more than one connection currently exists, the required connection can be selected from the combo box on the left-hand side. The required root object can then be selected from the right-hand side combo box. All the XML Schemas currently in the repository for that root object are displayed in the dialog box. The name, location, and namespace of each schema are listed.

Note that the stored schemas can also be viewed in the Database Query window (*screenshot below*), but they cannot be managed there. To manage schemas, use the XML Schema Management for Databases dialog.

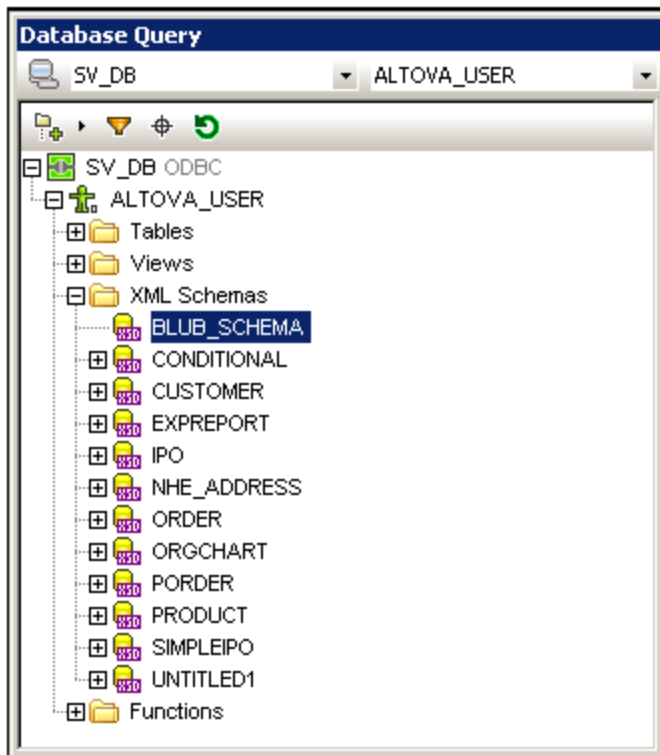

In the XML Schema Management dialog you can do the following:

- Add a schema using the **Add Schema** button. The selected schema will be appended to the list and marked for addition.
- Mark schemas in the list for deletion with the **Drop Schema** button. The Drop flag can be removed with the **Remove Drop Flag** button.
- Open a selected schema in Schema View by clicking the **View Schema** button.
- Commit the addition and drop (deletion) changes with the **Commit Changes** button.

After changes have been committed, a report of the commit action can be viewed in the Report tab (screenshot below).

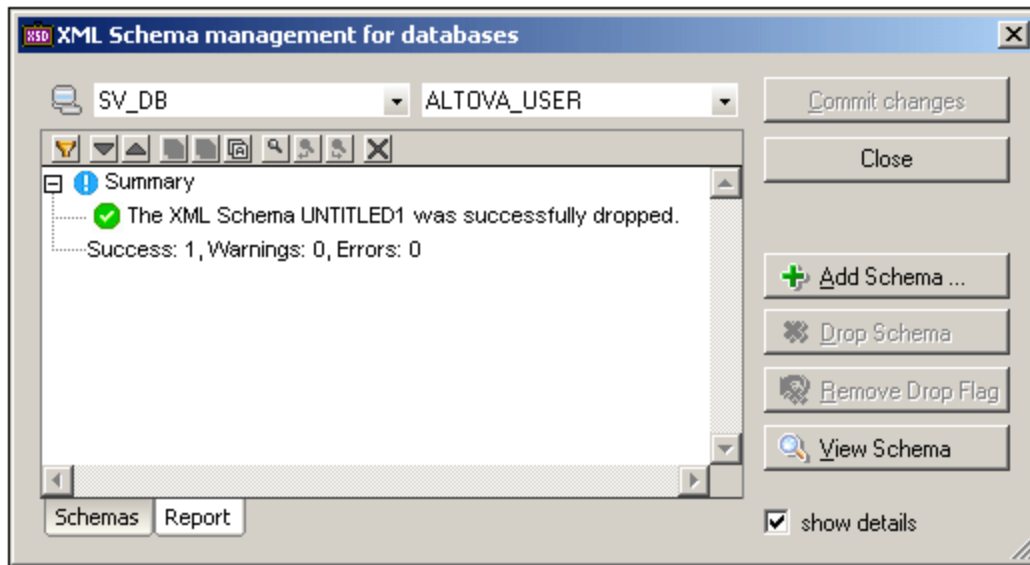

25.10.4 Oracle XML DB

XMLSpy allows you to connect to and query Oracle XML Db databases.

The following database functions are supported:

- Add (and register) an XML schema to the Oracle XML Db. The Oracle XML DB client must be installed for you to be able to register XML schemas through XMLSpy.
- Open and delete schemas
- Query the database using XPath statements (DBUri)
- Browse XML documents (using WebDAV)
- Create an XML document based on a schema saved in the database

General installation process:

- Download and install XMLSpy
- Install Oracle server (if necessary)
- Create an Oracle database

25.10.4.1 Manage XML Schemas

XML Schema management for databases enables you to add and delete XML Schemas from the schema repository of an XML database. After connecting to the database, XMLSpy provides the XML Schema Management for Databases dialog, in which XML Schemas can be managed.

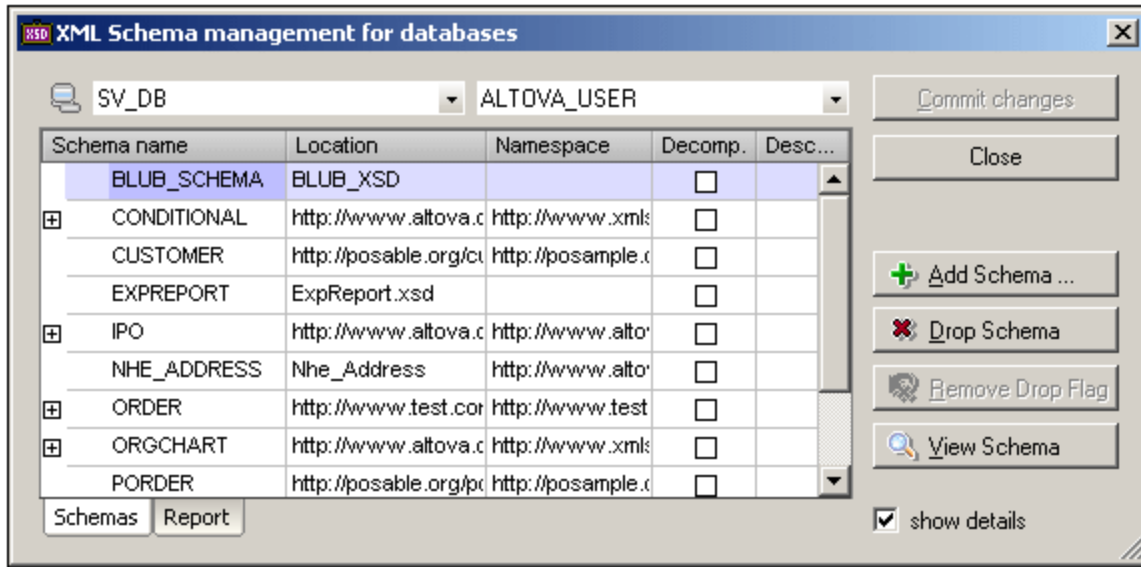

The dialog box provides a Quick Connect  icon which calls the [Quick Connect wizard](#) ⁶¹⁰ to connect to a data source. If more than one connection currently exists, the required connection can be selected from the combo box on the left-hand side. The required root object can then be selected from the right-hand side combo box. All the XML Schemas currently in the repository for that root object are displayed in the dialog box. The name, location, and namespace of each schema are listed.

Note that the stored schemas can also be viewed in the Database Query window (*screenshot below*), but they cannot be managed there. To manage schemas, use the XML Schema Management for Databases dialog.

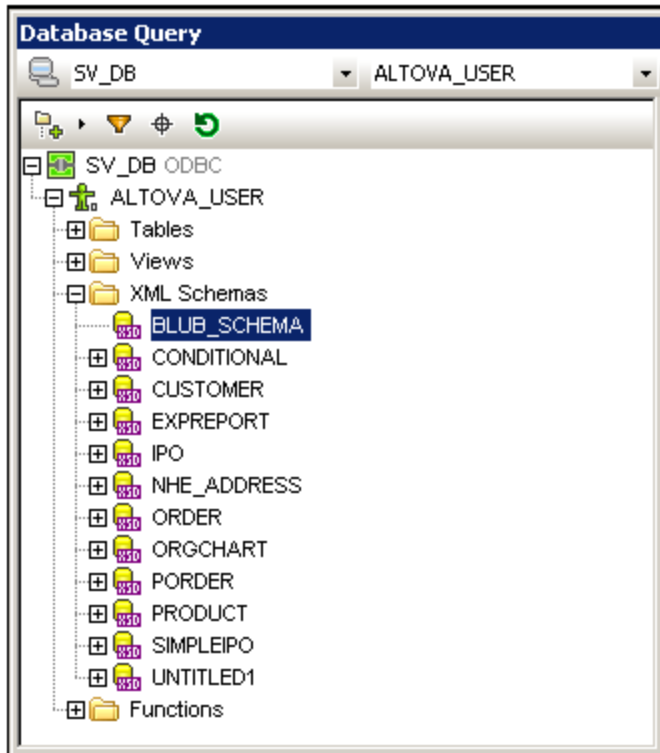

In the XML Schema Management dialog you can do the following:

- Add a schema using the **Add Schema** button. The selected schema will be appended to the list and marked for addition.
- Mark schemas in the list for deletion with the **Drop Schema** button. The Drop flag can be removed with the **Remove Drop Flag** button.
- Open a selected schema in Schema View by clicking the **View Schema** button.
- Commit the addition and drop (deletion) changes with the **Commit Changes** button.

After changes have been committed, a report of the commit action can be viewed in the Report tab (screenshot below).

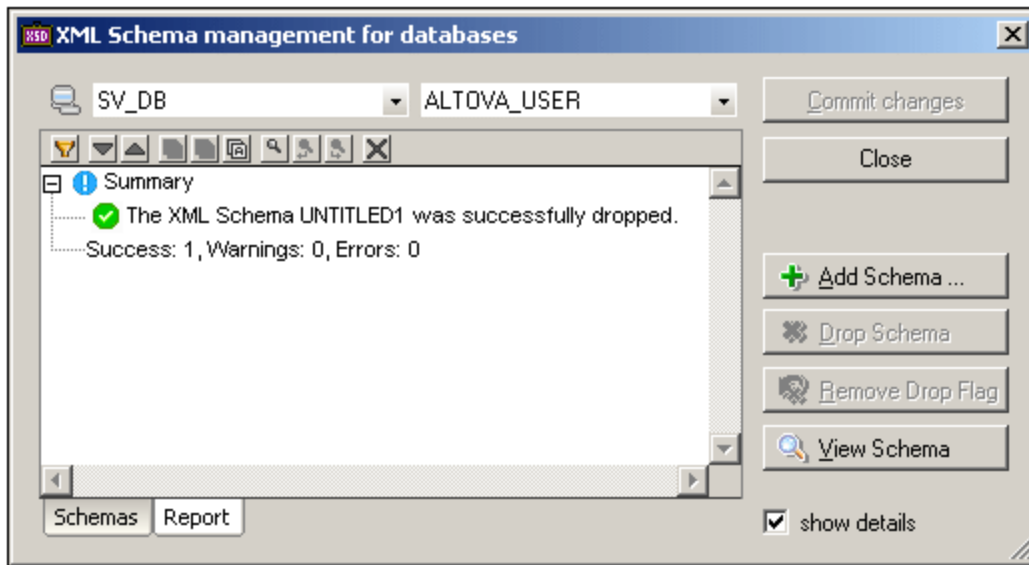

25.10.4.2 Browse Oracle XML Documents



This command allows you to browse the XML documents available on your server. The server details are automatically filled in if you previously queried the database or listed schemas. If this is not the case, then you have to enter them manually.

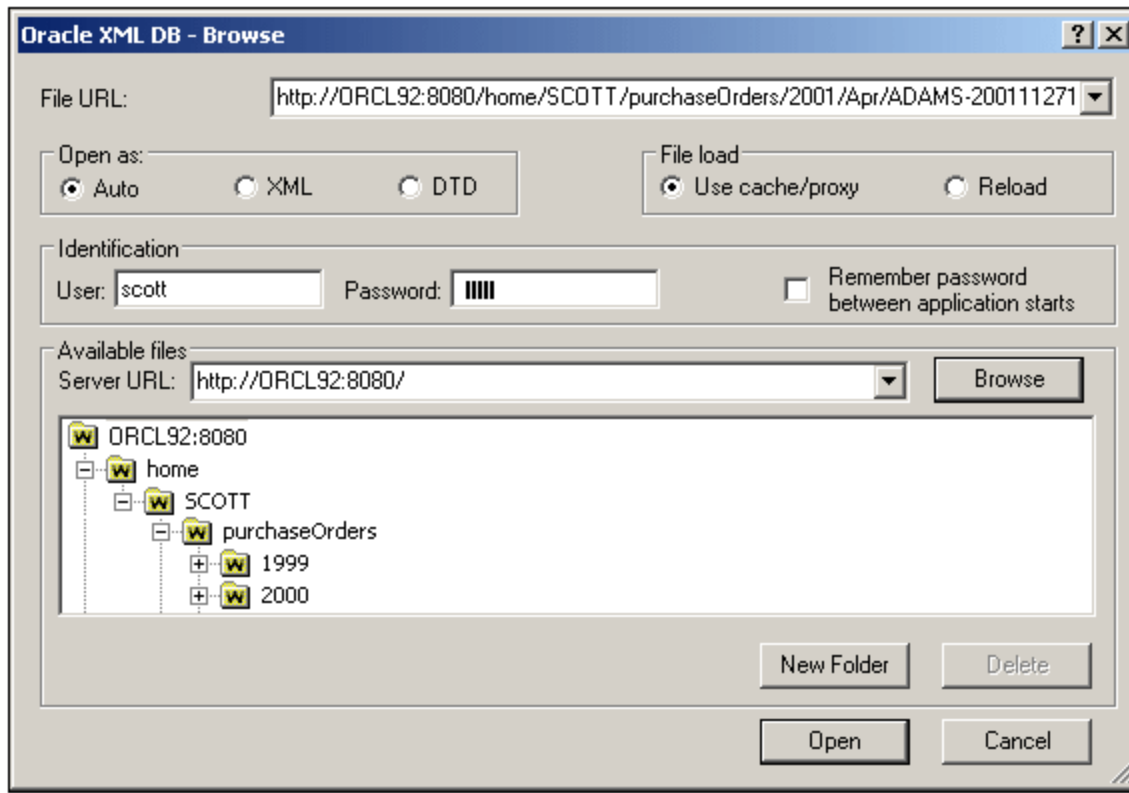

Use the tree view to find specific XML files. Double clicking a file in the tree view opens it. You can also click a file and click **Open** to achieve the same thing. The **New Folder** button adds a new folder, the **Delete** button deletes the currently selected XML file.

25.11 Convert Menu

The **Convert** menu (*screenshot below*) provides powerful data exchange functionality between data formats:

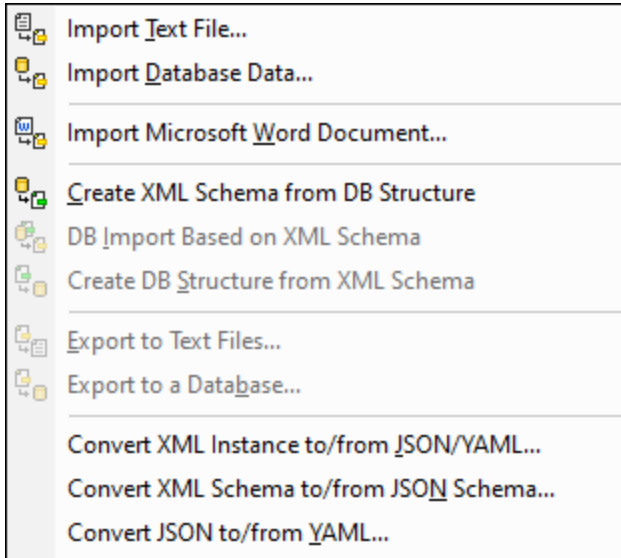

- Import and export text, word processor, database, and XML files.
- [Import database](#) ⁹⁷⁴ data based on an existing XML Schema.
- [Create an XML Schema](#) ⁹⁶⁹ based on the structure of an existing database.
- Create a [database structure](#) ⁹⁷⁵, based on an existing XML schema.
- Convert [between XML instances and JSON instances](#) ⁹⁸⁴, [between XML Schemas and JSON Schemas](#) ⁹⁸⁷, and [between JSON and YAML instance documents](#) ⁹⁹⁰.

25.11.1 Import Text File



This command lets you **import** any **structured text** file into XMLSpy and convert it to XML format immediately. This is useful when you want to import legacy data from older systems. The steps for importing data in a text file as an XML document are described below.

1. Select the menu item Convert | Import Text File.
2. In the dialog that appears (*screenshot below*), select one of the two options. (For the mapping option to work, [Altova MapForce](#) must be installed.)

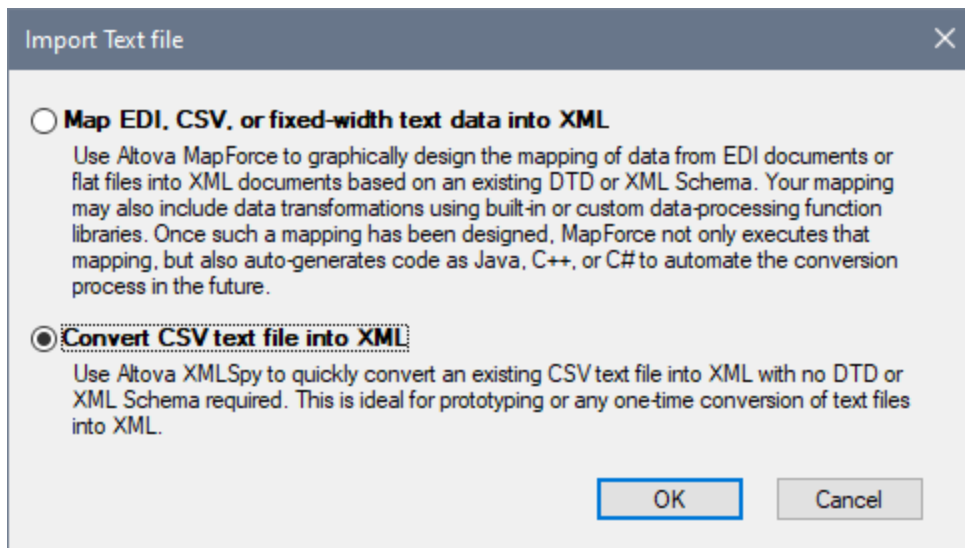

3. Click OK. The Text Import dialog appears.
4. Select the text import options you want (described in the next section) and click Import. The imported data is converted into an XML document and this is displayed in Grid View.

Text Import options

The text import options are specified in the Text Import dialog (*screenshot below*) and are described below. See previous section for information on accessing the dialog..

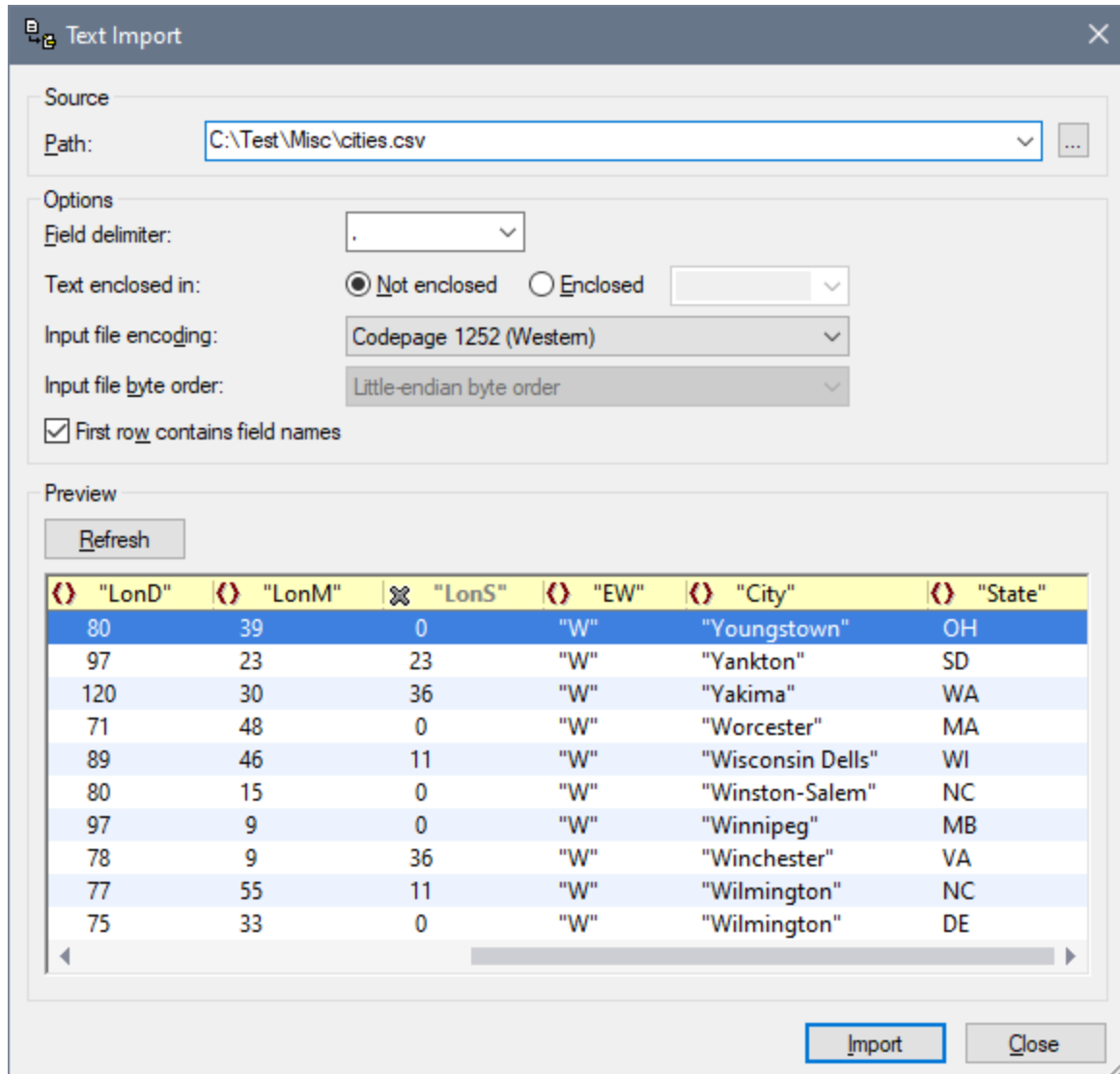
**Path**

Enter the path to the file to import in the Path text box, or select the file using the Browse button to the right of the text box. After the file is selected, a Grid View preview of the XML file is displayed in the Preview pane. Any change in the options selected in this dialog will be reflected in the preview immediately.

Delimiter

To successfully import a text file, you need to specify the field delimiter that is used to separate columns or fields within the file. XMLSpy will auto-detect common row separators (CR, LF, or CR+LF).

String quotes

Text files exported from legacy systems sometimes enclose textual values in quotes to better distinguish them from numeric values. If this is the case, you can specify what kind of quotes are being used in your file, and remove them automatically when the data is imported.

Encoding

The data is converted into [Unicode](#)¹⁶⁶² (the basis of all XML documents), so you need to specify which character-set the file is currently encoded in. For US or Western European Windows systems this will most likely be Codepage 1252, also referred to as the ANSI encoding.

Byte order

If you are importing 16-bit or 32-bit Unicode (UCS-2, UTF-16, or UCS-4) files, you can also switch between little-endian and big-endian byte order.

First row contains column names

It is also very common for text files to contain the field names in the first row within the file. If this is the case, check this check box.

Preview

In the Preview pane you can rename column headers by clicking in a name and editing it. The column headers will be the element or attribute names in the XML document. You can also select whether a column should be an element or an attribute in the XML document, or whether it should not be imported into the XML document. Click the column-type icon in each column header to toggle through these options. For example, in the screenshot above, the *Longitude in Seconds* column (*LonS*) will not be imported.

25.11.2 Import Database Data



The **Import Database Data** command enables you to import data from any of a variety of databases into an XML file. The import mechanism involves two steps:

1. A connection to the database is established. For instructions, see [Connecting to a Database](#)⁶⁰⁹.
2. The [data to be imported is selected](#)⁹⁶⁵.

Select the import command

To import database data, do the following:

1. When you click the Import Database Data command, the Import Database Data dialog (*screenshot below*) appears.

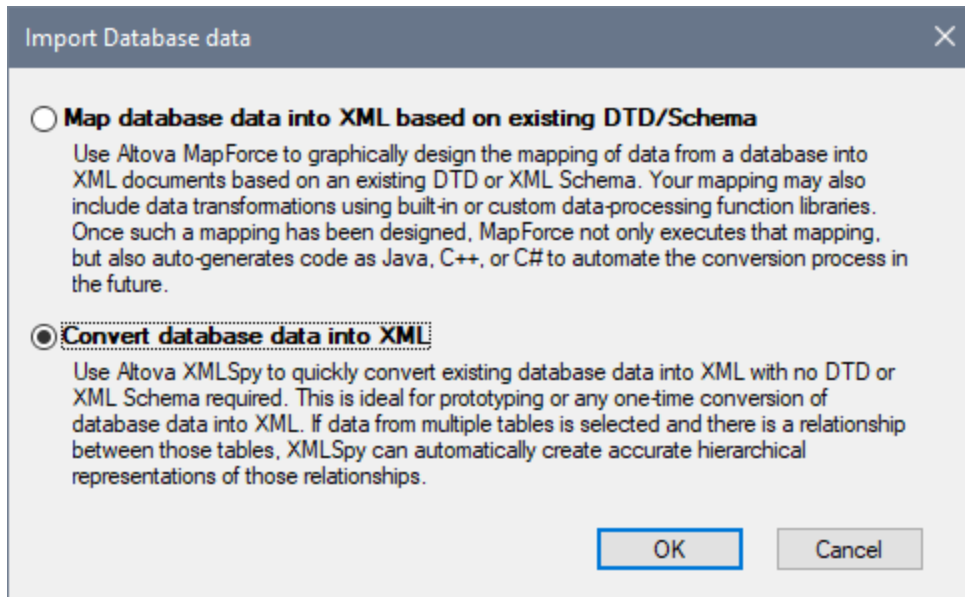

2. Select *Convert Database Data into XML* and click **OK**. (For the mapping option to work, [Altova MapForce](#) must be installed.)
3. In the Connect to Data Source dialog that appears, you establish a connection to the database. For instructions, see [Connecting to a Database](#)⁶⁰⁹.
4. After the connection to the database is established, the Import Database Data dialog displays tabs and windows that enable you to select the database data to import. These options are described below. After finishing, click the **Import** button to import the database data as an XML document.

Data selection and import options

The Import Database Data dialog for setting the selection and import options consists of two parts (*shown separately in the screenshots below*):

- an upper part with two tabs: (i) Selection, and (ii) Options.
- a lower part, which is a Preview window showing the data according to the data selection and import options.

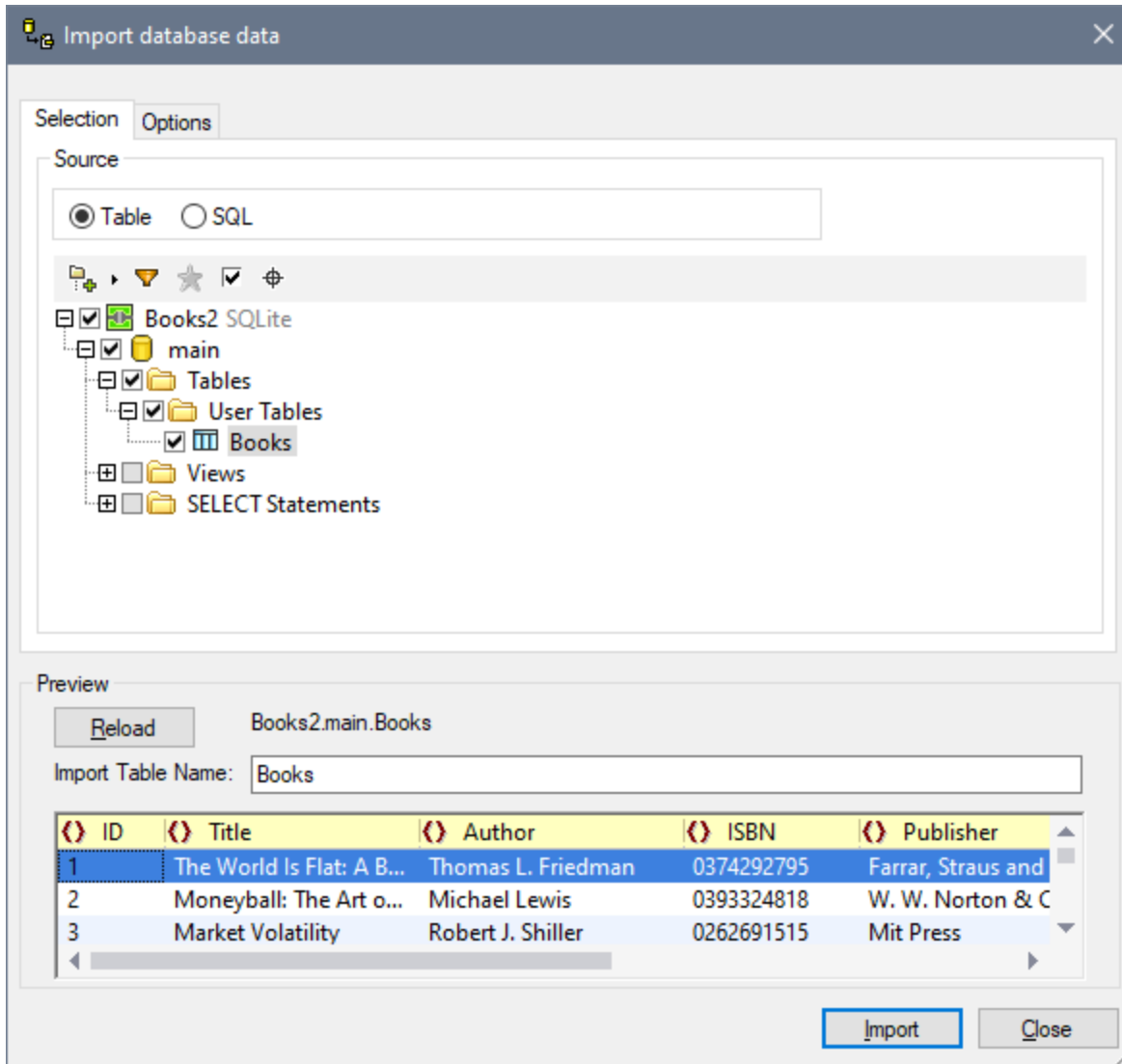

Data selection method

In the *Selection* tab (screenshot above), the *Source* pane (screenshot below) displays either a representation of the tables of the database or an editable SQL statement for selecting the required tables, each view being selected by clicking the respective radio button.



Table selection options

In the Table selection view, you can select the database tables to import by checking the table's check box (see the *Table Selection screenshot above*). The contents of the table can then be displayed in the Preview pane by clicking the **Preview** button.

The table selection view provides selection commands via icons in a toolbar (*screenshot below*).



These icons are, from left:

- *Folders Layout*: which enables you to organize database objects into: (i) folders based on object type; (ii) folders based on object type, but without schema folders; (iii) in a hierarchy, but without folders; and (iv) categories of tables, based on their relationships with other tables.
- *Filter folder contents*: applies a filter to the selected folder, enabling the folder's objects to be filtered. For example, in the screenshot below, a filter has been applied to display tables that contain the text **sysNav** in its name. Clicking the icon pops up a menu with a list of filter possibilities.

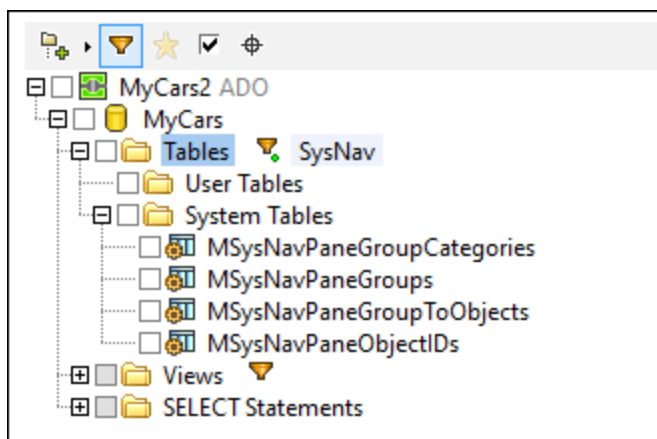

- *Show favorites*: Filters the objects displayed to favorites.
- *Show checked objects only*: Filter the objects displayed to checked objects.

- *Object Locator*: Displays a text field which behaves like a Search entry field. You can enter a text string and the dropdown list will display all the objects with names that contain the text string. Selecting one of these objects from the dropdown list will highlight that object in the tree.

Options tab

In the Options tab (*screenshot below*), you can specify how number, date, and time values are to be imported; whether data is imported as elements or attributes; and whether comments and `NULL` fields are to be included in the import.

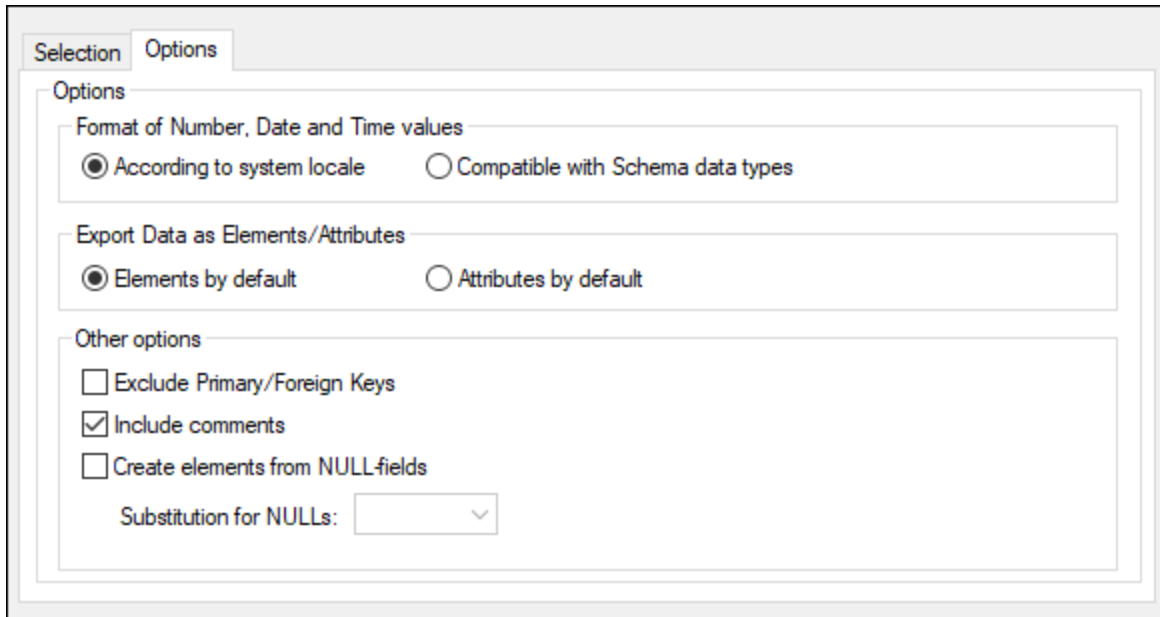

The screenshot shows a dialog box with two tabs: "Selection" and "Options". The "Options" tab is active. It contains three sections:

- Format of Number, Date and Time values**: Two radio buttons. The first, "According to system locale", is selected. The second is "Compatible with Schema data types".
- Export Data as Elements/Attributes**: Two radio buttons. The first, "Elements by default", is selected. The second is "Attributes by default".
- Other options**: Three checkboxes and a dropdown menu.
 - Exclude Primary/Foreign Keys
 - Include comments
 - Create elements from NULL-fields
 - Substitution for NULLs: [dropdown menu]

When `NULL` fields are enabled for import, you can enter a substitution XML value for them.

Preview pane

The Preview pane (*screenshot below*) displays the structure of the table currently selected in the Selection tab. When a new table is selected in the Selection tab, click the **Preview** button in the Preview pane to display the table. Click the **Reload** button to refresh the preview.

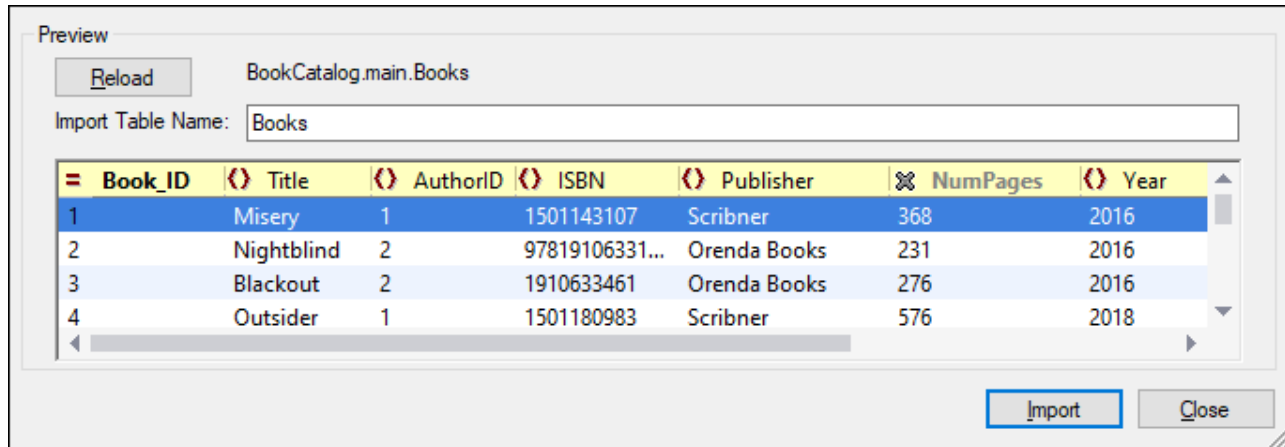

When the records are imported, each field can be imported as either an element or an attribute of the record. Alternatively, you can choose to not import a field. To specify whether a field is to be imported as an element or attribute or not imported at all, click the symbol to the left of the column name. Repeated clicks will cycle you through the three options. In the screenshot above, for example, the `Book_ID` field has been set to be imported as an attribute, the `NumPages` field to not be imported, and all other fields to be imported as elements.

Datatype conversions

Information about the conversion of database datatypes to XML Schema datatypes is listed in the [Appendices](#)¹⁶⁴⁷.

25.11.3 Import Microsoft Word Document



This command enables the direct import of a Microsoft Word document and its conversion into XML. On selecting this command, the Open dialog box appears in which you select the Word document you want to import. XMLSpy automatically generates an XML document with included CSS stylesheet. Each Word document paragraph generates an XML element, the name of which is derived from the corresponding paragraph style in the Word document.

25.11.4 Create XML Schema from DB Structure



The **Create XML Schema from DB Structure** command enables you to create an XML Schema from the structure of any of a variety of databases. The XML Schema-creation mechanism involves two steps:

1. A connection to the database is established. For instructions, see [Connecting to a Database](#) ⁶⁰⁹.
2. Options for the database data selection and the XML Schema are specified. These are described below.

Select the data structure to import

After having established a connection to the database, the Create XML Schema from DB Structure dialog is displayed (*screenshot below*). Here you can select the database structure to import. After doing this, click Import to create an XML Schema that defines this structure for an XML document.

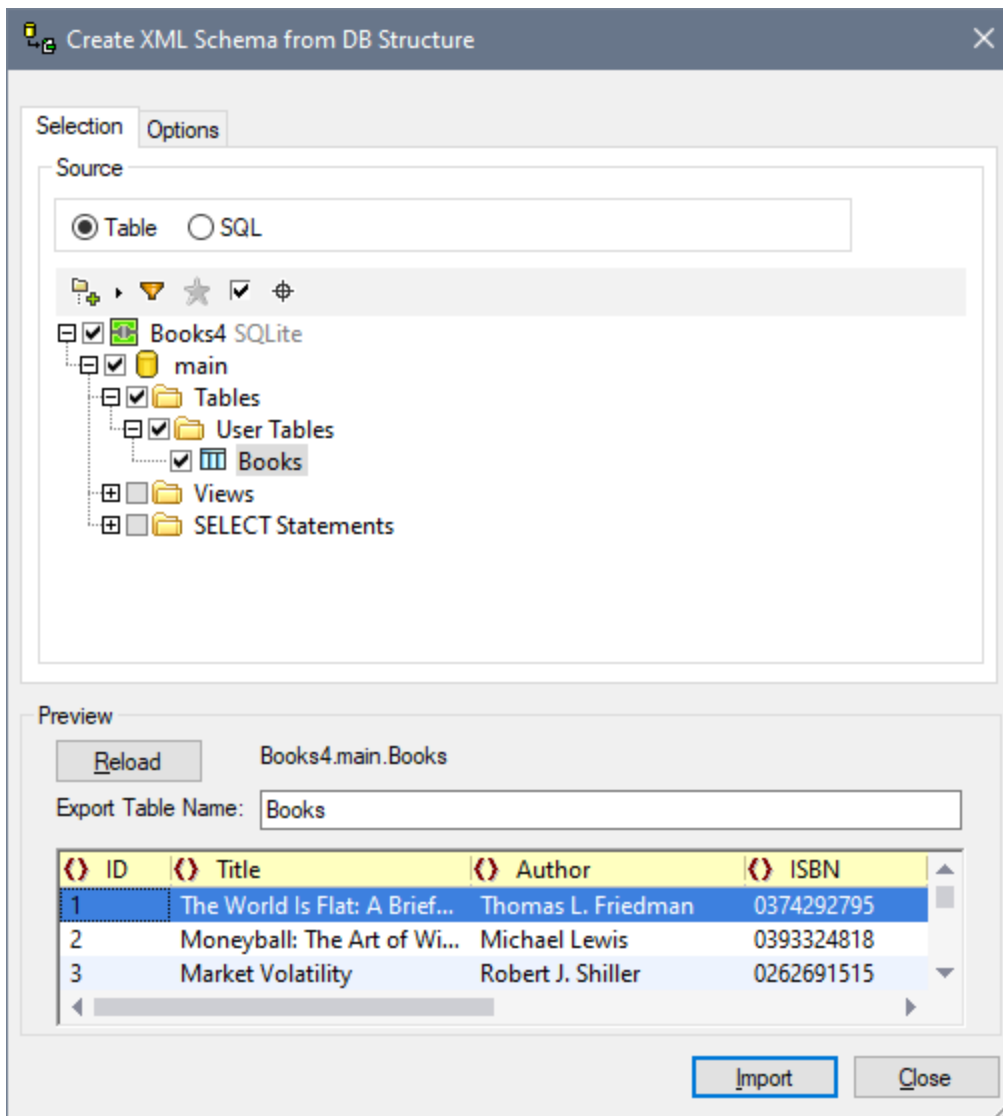

Data selection method

In the *Selection* tab (*screenshot above*), the *Source* pane (*screenshot below*) displays either a representation of the tables of the database or an editable SQL statement for selecting the required tables, each view being

selected by clicking the respective radio button.



Table selection options

In the Table selection view, you can select the database tables to import by checking the table's check box (see the *Table Selection screenshot above*). The contents of the table can then be displayed in the Preview pane by clicking the **Preview** button.

The table selection view provides selection commands via icons in a toolbar (*screenshot below*).



These icons are, from left:

- *Folders Layout*: which enables you to organize database objects into: (i) folders based on object type; (ii) folders based on object type, but without schema folders; (iii) in a hierarchy, but without folders; and (iv) categories of tables, based on their relationships with other tables.
- *Filter folder contents*: applies a filter to the selected folder, enabling the folder's objects to be filtered. For example, in the screenshot below, a filter has been applied to display tables that contain the text **sysNav** in its name. Clicking the icon pops up a menu with a list of filter possibilities.

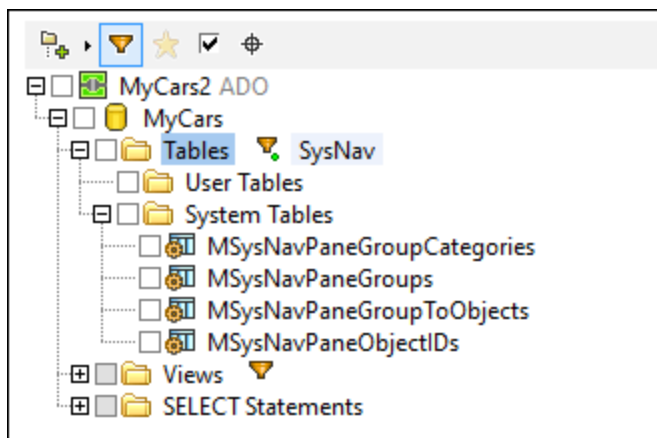

- *Show favorites*: Filters the objects displayed to favorites.

- *Show checked objects only*: Filter the objects displayed to checked objects.
- *Object Locator*: Displays a text field which behaves like a Search entry field. You can enter a text string and the dropdown list will display all the objects with names that contain the text string. Selecting one of these objects from the dropdown list will highlight that object in the tree.

Options tab

In the *Options* tab (*screenshot below*), you can specify the format of the schema, its extension type, whether columns should be imported as elements or attributes, and the database constraints that should be generated in the schema.

Schema format

You can select between a flat (SQL/XML Standard) and a hierarchical schema form.

- The *flat schema model* is based on an ISO-ANSI SQL/XML specification [INCITS/ISO/IEC 9075-14-2008](#). The SQL/XML specification defines how to map databases to XML. Relationships are defined in schemas using identity constraints; there are no references to elements. Hence the schema is flat structure which resembles a tree-like view of the database. The specification can be purchased at the [ANSI store](#). For more information, see [www.iso.org](#).
- The *hierarchical schema model* displays the table dependencies visually, in a type of tree view where dependent tables are shown as indented child elements in the content model. Table dependencies are also displayed in the Identity constraints tab.

Tables are listed as global elements in the schema, and columns are the elements or attributes of these global elements (The user decides whether to map the columns as elements or as attributes). Relationships are created in a hierarchical way so that a foreign key field in one table is actually a reference to the global element that represents that table.

Schema extension type

Schema extension information is additional information read from a database that is then embedded in the schema as either annotation data or attributes. There are four extension type options when generating

schemas: (i) no extensions information; (ii) SQL/XML extensions; (iii) MS SQL Server extensions; and (iv) Oracle extensions. These are described below:

- *None*: No additional information is provided by the database.
- *SQL XML*: SQL/XML extensions are only inserted when generating schemas in a flat format. The extension information is stored in annotations and is described in the SQL/XML specification ([INCITS/ISO/IEC 9075-14-2008](#)).
- *MS SQL Server*: Selecting Microsoft SQL Server generates SQL Server extensions. See [SQL Server Books Online](#) for resources and [MSDN's information about annotating XSD schemas](#). The following annotation-related elements are generated in the schema: `sql:relation`, `sql:field`, `sql:datatype`, `sql:mapped`.
- *Oracle*: Oracle extensions are selected by default when working with an Oracle database. Additional database information is stored as attributes. Detailed information can be found in [Oracle's online documentation](#). The following subset of attributes is currently generated: `SQLName`, `SQLType`, `SQLSchema`.

Note: Although SQL Server and Oracle extensions can be generated for their respective databases they are not restricted in this way. This proves useful when working with a third database and wanting to generate a schema that later should be working with either SQL Server or Oracle.

Preview pane

The Preview pane (*screenshot below*) displays the structure of the table currently selected in the Selection tab. When a new table is selected in the Selection tab, click the **Preview** button in the Preview pane to display the table. Click the **Reload** button to refresh the preview.

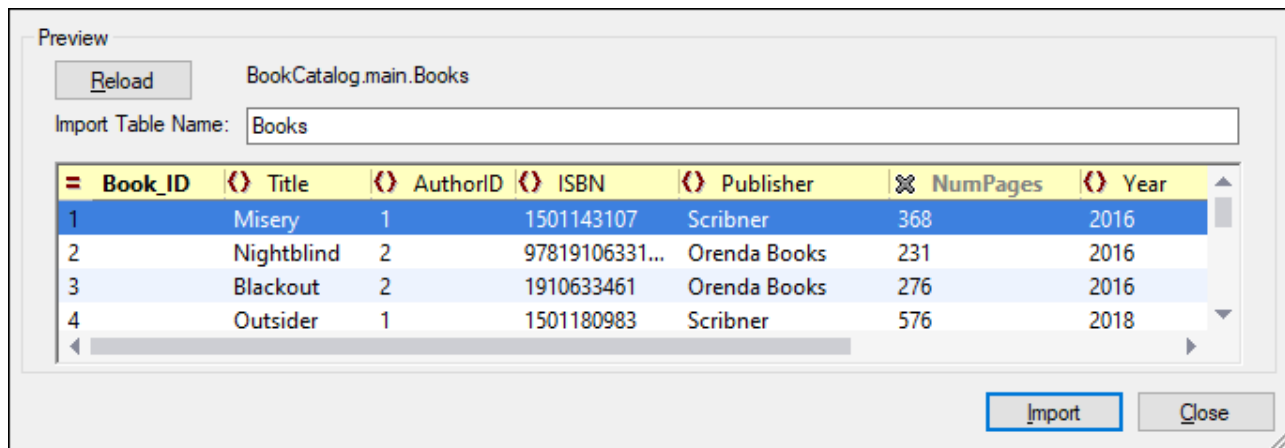

When the records are imported, each field can be imported as either an element or an attribute of the record. Alternatively, you can choose to not import a field. To specify whether a field is to be imported as an element or attribute or not imported at all, click the symbol to the left of the column name. Repeated clicks will cycle you through the three options. In the screenshot above, for example, the `Book_ID` field has been set to be imported as an attribute, the `NumPages` field to not be imported, and all other fields to be imported as elements.

Datatype conversions

Information about the conversion of database datatypes to XML Schema datatypes is listed in the [Appendices](#)¹⁶⁴⁷.

25.11.5 DB Import Based on XML Schema



The **DB Import Based on XML Schema** command creates an XML document which is valid according to a given XML Schema and contains data imported from a database. For this feature, the following databases are supported:

- Microsoft Access 2000 and 2003
- Microsoft SQL Server
- Oracle
- MySQL
- Sybase
- IBM DB2

The data to be imported is determined by the table that is selected in the database. With the required XML Schema (that on which you wish to base the import) as the active document in Schema View, connect to the database. Then select the table/s you wish to import, and click Import. The data is imported into an XML document, and the document has the structure of the XML Schema that was active when the data was imported.

In the example below, data from an MS Access database is imported with an XML Schema active in Schema View. These would be the steps to carry out for the import:

1. Open the schema file in Schema View (*screenshot below*).

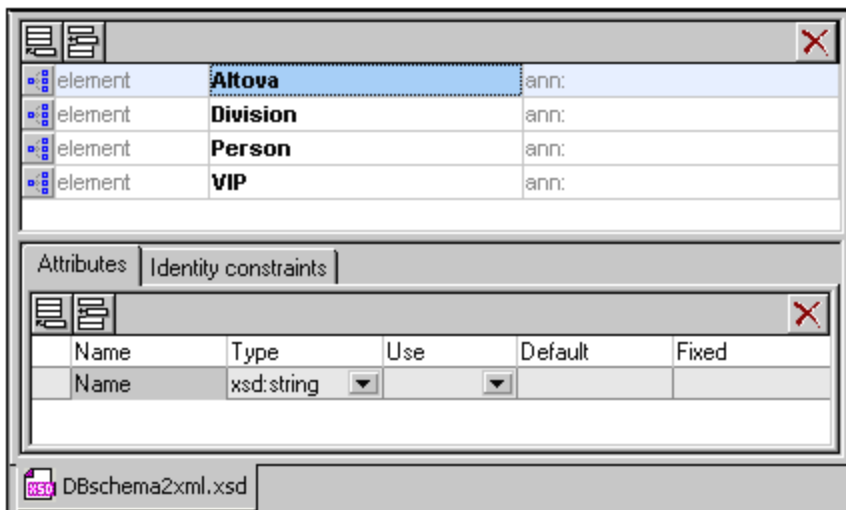

2. Select the menu command **DB Import based on XML Schema**. This opens the [Connect to Data Source](#) ⁶¹⁰ dialog.
3. Select the Microsoft Access (ADO) option and click **Next**.
4. Click **Browse** and select the database file. Then click **Next**.
5. In the DB Import Based on XML Schema dialog which pops up, go to the Tables tab, select one or more tables you wish to import (for example, *Altova*), then click **Import**. The table is imported into an XML document that is displayed in Grid View.

Datatype conversions

Information about the conversion of database datatypes to XML Schema datatypes is listed in the [Appendices](#)¹⁶⁴⁷.

25.11.6 Create DB Structure from XML Schema



XMLSpy allows you to create an empty database (or skeleton database) based on an existing schema file. The method described below is generally the same for each type of database.

1. Open the schema file in Schema/WSDL View
2. Select the menu command **Convert | Create DB Structure from XML Schema**. This pops up the [Connect to a Data Source](#)⁶¹⁰ dialog, which enables you to connect to a database (DB).
3. Use the steps described in the section [Connecting to a Data Source](#)⁶¹⁰ to connect to the required database. For example, to connect to a Microsoft Access database, select the Microsoft Access radio button, and continue the process to select a database. You can use an existing database or create a new database in which the schema structure will be contained.
4. In the Create DB Structure from XML Schema dialog, tables are created from the schema and displayed in a tree format at the location where they will occur in the DB. For example, in the screenshot below, the Address table is created and selected for export. Tables that should not be exported should be deselected (by unchecking the check box or selecting the appropriate item from the context menu for that table).

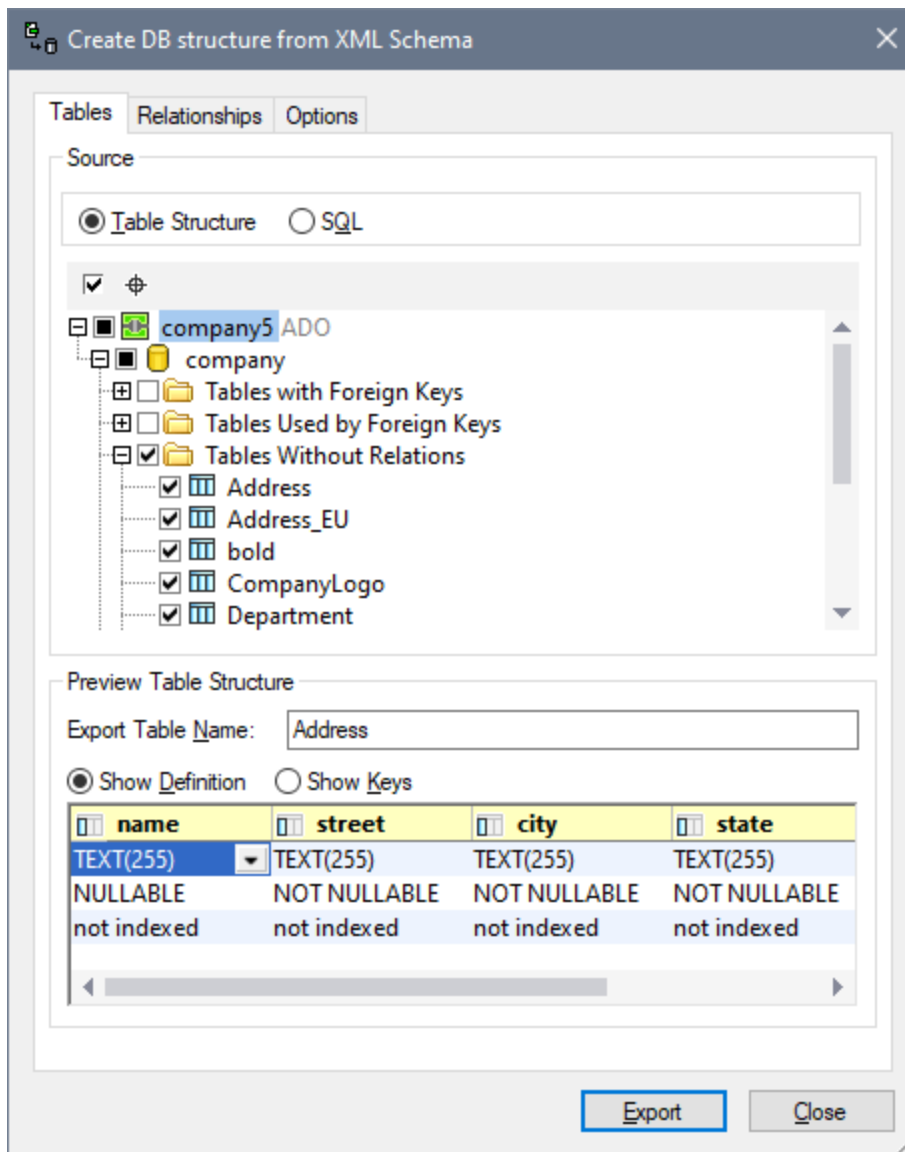

Creating DB tables with relationships

If the XML Schema from which the DB structure is generated has relationships defined in the form of identity constraints, then these relationships are automatically created in the generated DB structure and displayed in the Table Structure. Tables with relationships are listed under the sections: Tables with ForeignKeys and Tables used by ForeignKeys. Tables without relationships are listed in the Independent Tables section.

In the Relationships tab, you can create and modify table relationships. The tab lists all possible primary-key/foreign-key relationships (*screenshot below*).

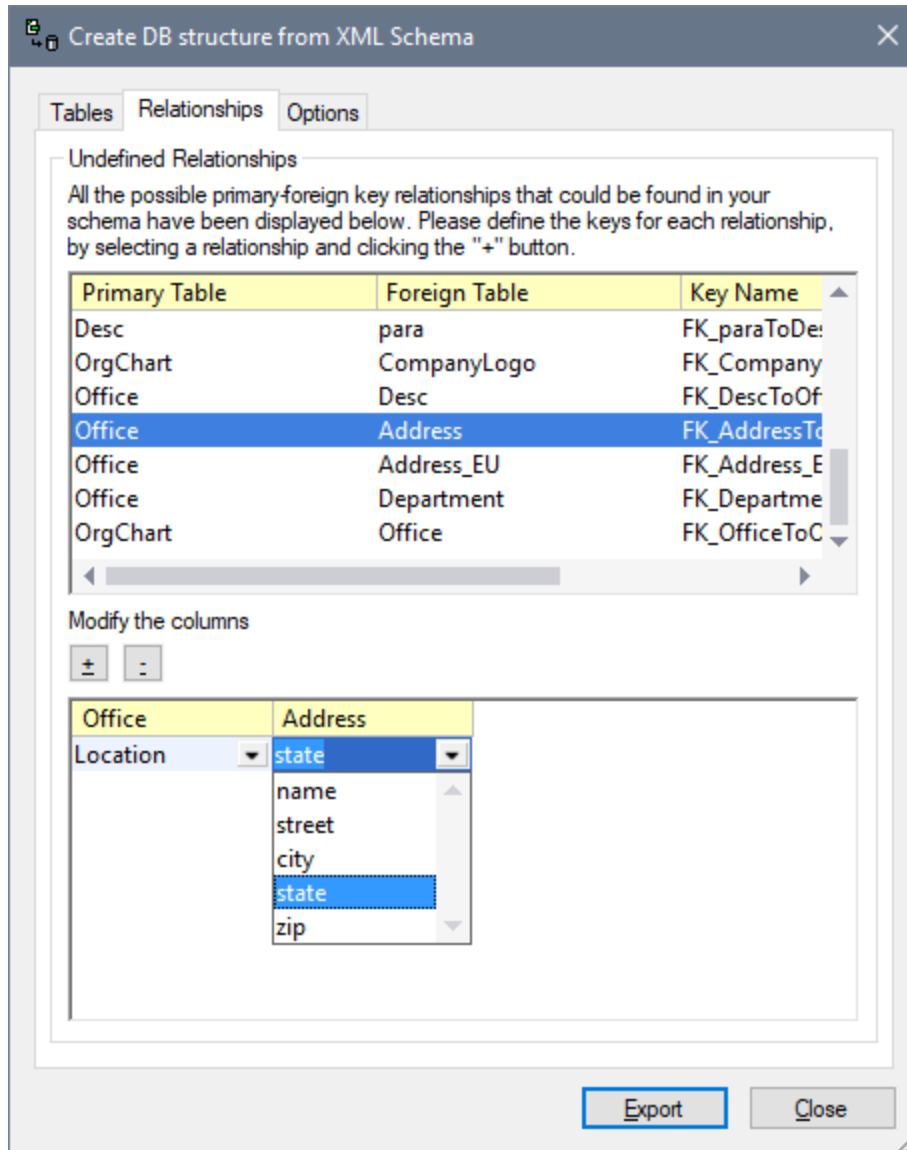

To create a relationship, do the following:

1. Select one of the possible primary-key/foreign-key relationships.
2. In the lower pane of the dialog, click the Plus button to create a relationship.
3. Select the required columns in each of the two tables from the respective dropdown lists.

You can also remove a relationship by selecting it and then clicking the Minus button.

Notes on database structure and connecting

The schema structure, defined by the identity constraints, is mirrored in the resulting database. The table below shows the type of database created, the restrictions, and the connecting methods, when using the **Create DB Structure from XML Schema** menu command.

| | Directly | Using ODBC | Using ADO |
|---------------------------|----------|------------|-----------|
| MS Access (2000 and 2003) | OK * | OK | OK |
| MS SQL Server | OK * | OK | OK |
| Oracle | OK * | OK | OK |
| MySQL | - | OK * | OK + |
| Sybase | - | OK * | OK |
| IBM DB2 | - | OK * | OK |

* *Recommended connection method for each database.*

+ *MySQL: When creating the ADO connection based on ODBC, it is recommended to use either the User or System DSN.*

- *Not supported*

XMLSpy will map both [hierarchical and flat formatted schemas](#)⁹⁶⁹. XMLSpy recognizes both formats automatically.

The flat format is mapped to SQL in two different ways.

- SQL Server DB, Oracle DB, or Sybase DB:
A schema that was generated in flat format, for one of the above databases, will have the schema catalog name extracted and used in the generated SQL script as the DB name. This means that the resulting SQL script will be executed on a target DB whose name must be identical to the schema catalog name.
- Access (2000 or 2003), MySQL, or DB2 DB:
A schema that was generated in flat format, for one of the above databases, will **ignore** the schema catalog name when the SQL script is generated. This means that the resulting SQL script will be executed on a target database that was logged into.

Datatype conversions

Information about the conversion of XML Schema datatypes to database datatypes is listed in the [Appendices](#)¹⁶⁴⁷.

25.11.7 Export to Text Files



The command **Convert | Export to Text Files** exports XML data into text formats for exchange with databases or legacy systems. On clicking this command, the Export XML to Text dialog pops. It consists of two parts (*shown in separate screenshots below*):

- an upper part with two tabs: (i) Selection, and (ii) Export Options.
- a lower part, which is a Preview window.

After you have selected the desired options in this dialog (*described below*), click the **Export** button to export to text file/s.

Selection

In the Selection tab (*screenshot below*), you can select the destination of the file to be exported and text generation options.

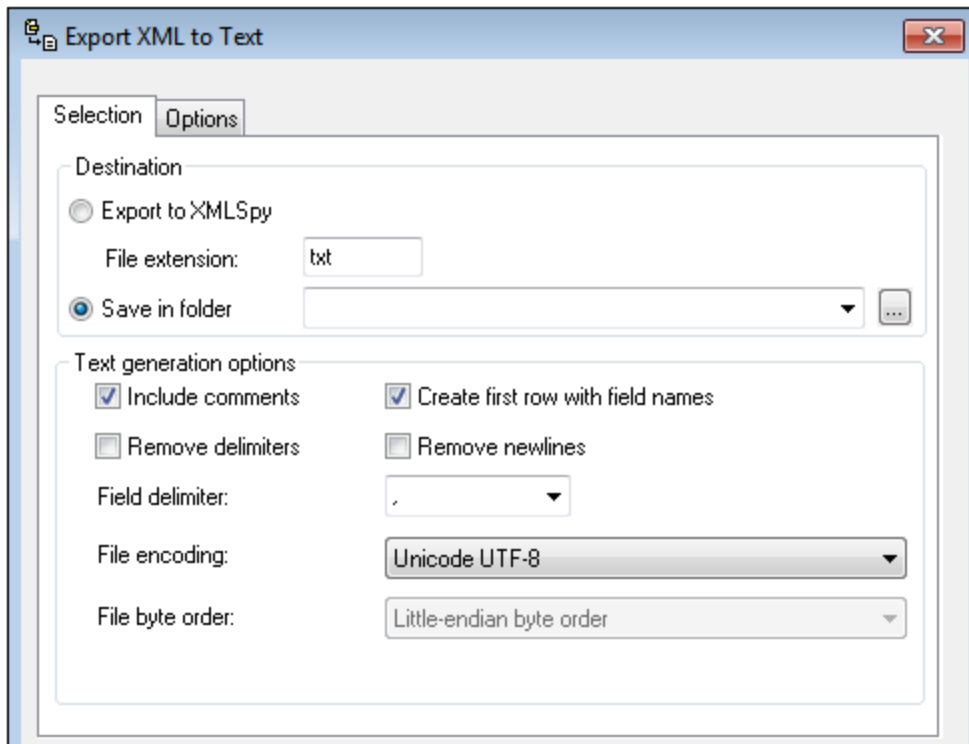

Destination: The exported file can be saved directly to a folder. The file extension can be specified. The filenames will be those of the elements (in the XML file) that will be exported. Alternatively, untitled files can be exported to XMLSpy. These files will be displayed in the GUI, and can be saved later.

Include comments: Activate this option to include an XMLSpy-generated comment in the exported XML file. The comment will contain the SQL query used to select the data as well as a list in which there is one listitem for each column header in the database table.

Create first row with field names: When activated, the exported tables include the names of columns from the database. Otherwise column names will not be included in the exported text file.

Remove delimiters: Removes delimiters that are contained in text values in the exported data. Set the delimiter you want to remove by using the Delimiter combo box in this tab. For example, if this option is activated and the selected delimiter is the apostrophe, when you export the XML value Ba'ker, the string will be Baker in the exported text.

Remove newlines: Removes newlines from exported data.

Delimiter: Select from the drop-down list the character that you wish to have removed during export. Alternatively, enter the desired character string.

Encoding: Select from the drop-down list, the desired encoding for files that are generated during export.

Byte order: If you are exporting 16-bit or 32-bit Unicode (UCS-2, UTF-16, or UCS-4) files, you can also switch between little-endian and big-endian byte order.

Export Options

Additional export options, which are described below, can be specified in the Options tab (*screenshot below*):

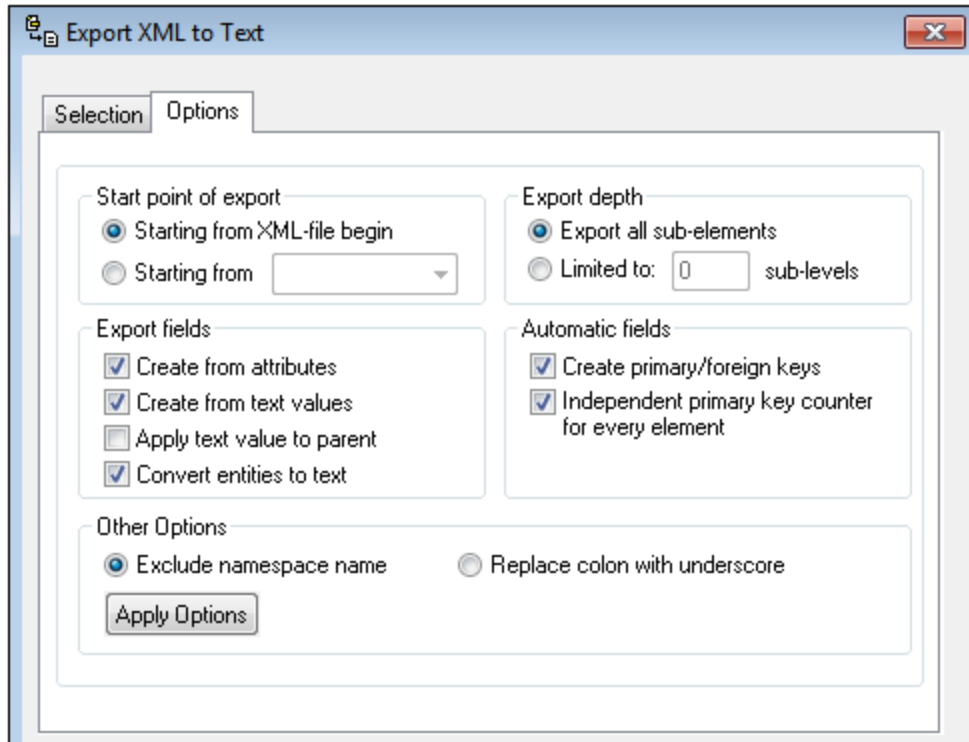

Start point of export: You can choose to export the entire XML document or restrict your export to the data hierarchy starting from the currently selected element. The number of sub-levels below the start point that will be exported is specified in the *Export Depth* option.

Export depth: Specifies the number of sub-levels below the start point that will be exported.

Export fields: Depending on your XML data, you may want to export only elements, attributes, or the textual content of your elements. Note that you can also deselect the export of individual elements in the Preview window.

Automatic fields: XMLSpy will produce one output file or table for each element type selected. You can choose to automatically create primary/foreign key pairs to link your data in the relational model, or define a primary key for each element.

Exclude namespace name: Together with the *Replace Colon With Underscore* radio button this is an either/or choice. Specifies whether namespace prefixes of elements and attributes should be excluded or whether the colon in the namespace prefix should be replaced with an underscore.

Apply Options: After you have set options, click this button to apply the options. The preview in the preview pane will be updated with the new options.

Preview window

The Preview window (*screenshot below*) is displayed below the Selection and Options tabs.

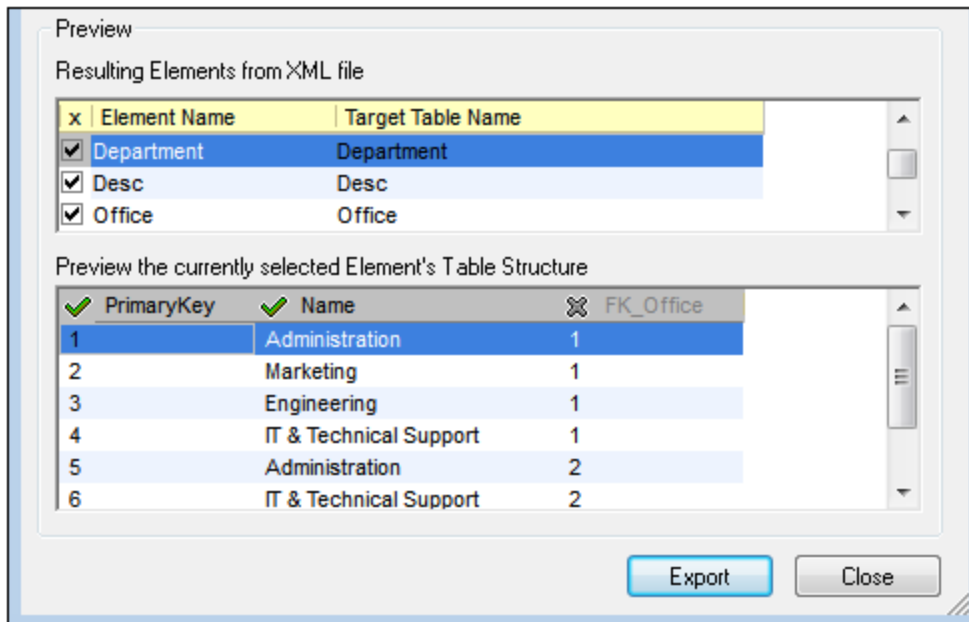

The *Resulting Elements from XML File* pane shows the node names that will be exported and the name in the generated file. You can select/deselect nodes that will be exported. When an element is selected, a preview of its structure is shown in a second pane below. In this pane, clicking to the left of a column header name toggles the export of that column on and off. In the screenshot above, the last column (*FK_Office*) has been toggled off.

25.11.8 Export to a Database



The command **Convert | Export to a Database** exports XML data to a database. On clicking this command, the Connection Wizard starts up and enables you to set up a connection to the database you wish to update. After a connection has been established, the Export Data to Database dialog pops. It consists of two parts (*shown separately in the screenshots below*):

- an upper part with two tabs: (i) Selection, and (ii) Export Options.
- a lower part, which is a Preview window.

After you have selected the desired options in this dialog (*described below*), click the **Export** button to export to the database.

Selection

In the Selection tab, you can select the destination database and table generation options. The destination field selects the connection to the database. You must select whether the data is created as new tables, updates existing tables, or first tries to update an existing table and then creates a new table if an update is not possible. You can also set a stop action based on the number of errors, and, optionally, SQL script logging.

Export Options

Export options, which are described below, can be specified in the Options tab (*screenshot below*):

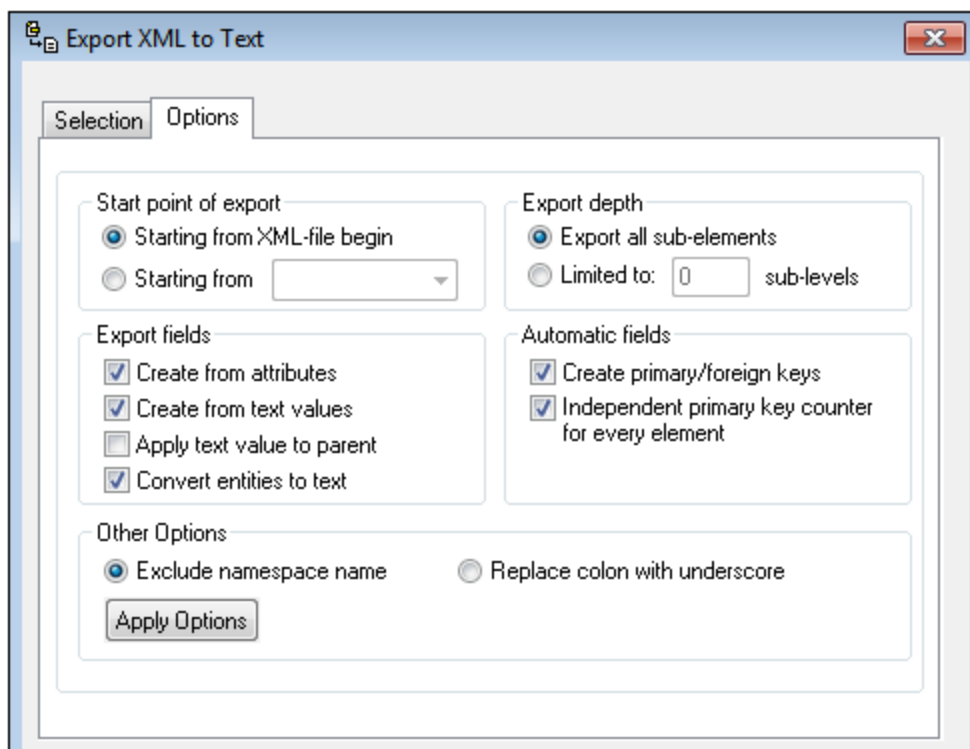

Start point of export: You can choose to export the entire XML document or restrict your export to the data hierarchy starting from the currently selected element. The number of sub-levels below the start point that will be exported is specified in the *Export Depth* option.

Export depth: Specifies the number of sub-levels below the start point that will be exported.

Export fields: Depending on your XML data, you may want to export only elements, attributes, or the textual content of your elements. Note that you can also deselect the export of individual elements in the Preview window.

Automatic fields: XMLSpy will produce one output file or table for each element type selected. You can choose to automatically create primary/foreign key pairs to link your data in the relational model, or define a primary key for each element.

Exclude namespace name: Together with the *Replace Colon With Underscore* radio button this is an either/or choice. Specifies whether namespace prefixes of elements and attributes should be excluded or whether the colon in the namespace prefix should be replaced with an underscore.

Apply Options: After you have set options, click this button to apply the options. The preview in the preview pane will be updated with the new options.

Preview window

The Preview window (*screenshot below*) is displayed below the Selection and Options tabs.

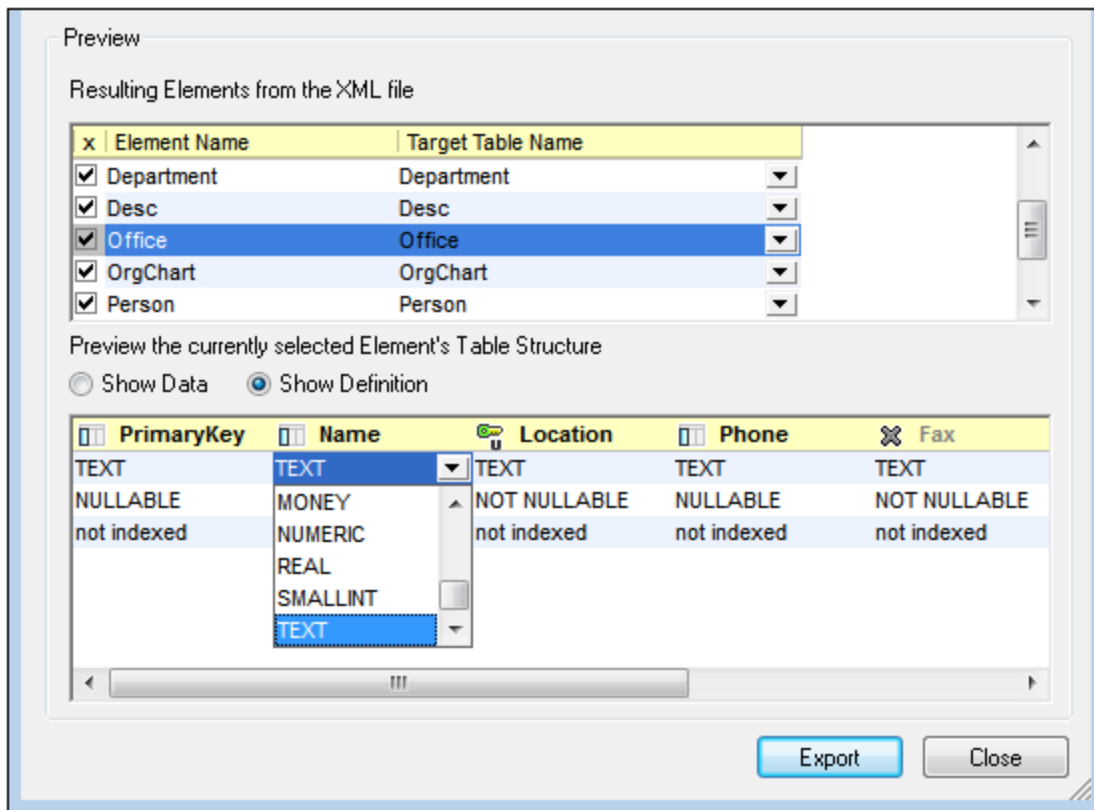

The *Resulting Elements from XML File* pane shows the name of the nodes in the XML document that will be exported and its corresponding name in the generated file. You can select/deselect nodes that will be exported. When an element is selected, a preview of its structure in the generated file is shown in a second pane below. This preview can be switched between a preview of: (i) data in the generated structure (*Show Data*); or (ii) definitions of each column in the generated structure (*Show Definition*). The screenshot above shows the column definitions.

In this second pane, clicking to the left of a column name cycles the column through four settings: (i) Include in table structure; (ii) Unique constraint; (iii) Primary Key constraint; (iv) Exclude from table structure. In the screenshot above, the *Location* column has a Unique constraint, while the *Fax* column has been excluded from the table structure. All the other columns are included in the table structure.

When the element's table structure shows field definitions (*Show Definition*), the definitions can be edited by selecting the definition and selecting an option from the definition's combo box (*see screenshot above*).

25.11.9 Convert XML Instance to/from JSON/YAML

If the active document is an XML document, this command generates a JSON or YAML document from it. If the active document is a JSON or YAML document, the command generates an XML document from it. The generated document is opened in a new window, and can then be saved to any location. Conversion options are described below. For information about JSON and JSON editing support in XMLSpy, see the section [JSON and JSON Schema](#)⁵⁰⁷. For information about YAML, see the section [YAML](#)⁵⁷⁴.

Sample conversions

Given below is an example of a source XML document, and, below it, the JSON and YAML documents generated from it by the **Convert XML Instance to/from JSON/YAML** command.

XML document

```
<?xml version="1.0" encoding="UTF-8"?>
<Person first="Jim" last="James">
  <Address>
    <street>4 New Street</street>
    <city>New York</city>
    <state>NY</state>
    <code>10123</code>
  </Address>
  <Tel type="home">
    123 123-1234
  </Tel>
  <Tel type="office">
    123 987-9876
  </Tel>
</Person>
```

To convert an XML document to JSON or YAML, make the XML document active and click the **Convert XML Instance to/from JSON/YAML** command.

JSON document

```
{
  "XML": {
    "version": 1.0,
    "encoding": "UTF-8"
  },
  "Person": {
    "first": "Jim",
    "last": "James",
    "Address": {
      "street": "4 New Street",
      "city": "New York",
      "state": "NY",
      "code": 10123
    }
  }
}
```

```
    },
    "Tel": [ { "type": "home",
              "Text": "\r      123 123-1234\r  " }, { "type": "office",
              "Text": "\r      123 987-9876\r  " } ]
  }
}
```

To convert a JSON document to XML, make the JSON document active and click the **Convert XML Instance to/from JSON/YAML** command.

YAML document

```
Person:
  "@first": Jim
  "@last": James
  Address:
    street: 4 New Street
    city: New York
    state: NY
    code: "10123"
  Tel:
    - "@type": home
      $: |
          123 123-1234
    - "@type": office
      $: |
          123 987-9876
```

To convert a YAML document to XML, make the YAML document active and click the **Convert XML Instance to/from JSON/YAML** command.

XML to JSON conversion options

When you click the **Convert XML Instance to/from JSON/YAML** command to convert an XML instance document to a JSON or YAML instance document, the Convert XML to JSON/YAML dialog (*screenshot below*) appears. You can select whether you wish to convert to JSON, JSON5, JSON Comments, or YAML. Then set the conversion options you want, and click **OK**. A JSON or YAML instance document will be generated from the XML instance, and the generated document will be opened in a new window.

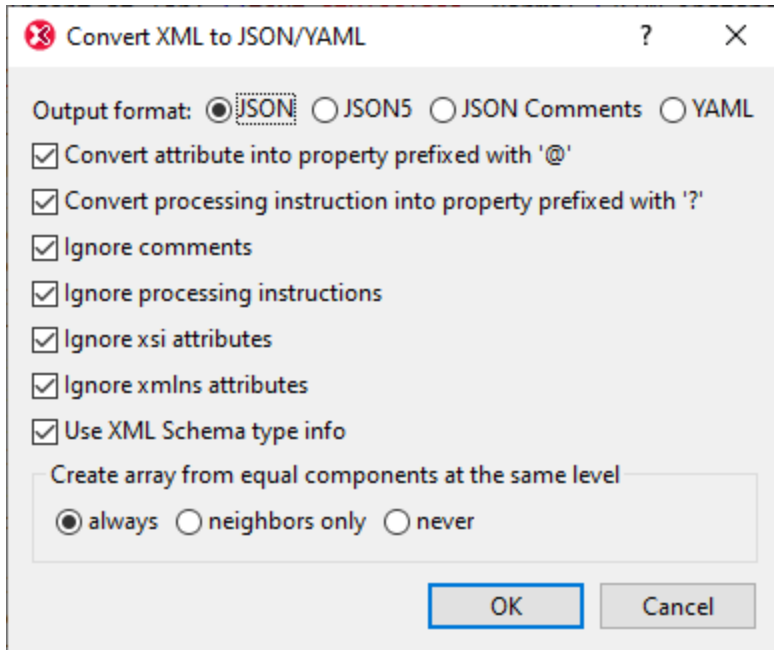

The first two options define whether prefixes should be added to JSON/YAML property names so that conflicts with elements at the same level are avoided. The two listings below explain this. The XML *attribute* `somenode` has been converted to the JSON property `@somenode`. In this way, a conflict with the JSON property `somenode` (created from the XML *element* `somenode`) is avoided.

XML instance

```
<root somenode="value">
  <somenode>content</somenode>
</root>
```

JSON instance

```
{
  "root": {
    "@somenode": "value",
    "somenode": "content"
  }
}
```

The next options enable you to specify whether certain types of XML nodes are to be converted or not. If XML comments are included they are given the name `"#"`. Text nodes (that typically occur in elements with mixed content) are given the name `"$"`. If an XML node has a namespace prefix, then the corresponding JSON/YAML name will be created with this namespace prefix. If elements with the same name exist at the same level, they are considered to be equal components. Similarly, nodes such as comments, processing instructions, and `text()` at the same level are also equal components. If equal components are present at the same level, you are able to choose whether to create an array or not. The options are whether to create the array out of all such equal components, only neighboring equal components, or not to create an array at all.

The *Use XML Schema type info* option enables conversions to be made on the basis of the XML Schema type of the source node. For example, if a node is defined in the schema as being of type `xs:string`, then the target JSON object's property will be of type `string` and will be enclosed in quotes. This is useful if, for example, a number is stored as a string in the source XML node and the conversion to JSON must also be faithful in terms of type.

JSON/YAML to XML conversion options

When you click the **Convert XML Instance to/from JSON/YAML** command to convert a JSON or YAML instance document to an XML instance document, the Convert JSON/YAML to XML dialog (*screenshot below*) appears. Set the conversion options you want, and click **OK**. An XML instance document will be generated from the JSON or YAML instance, and the generated XML document will be opened in a new window.

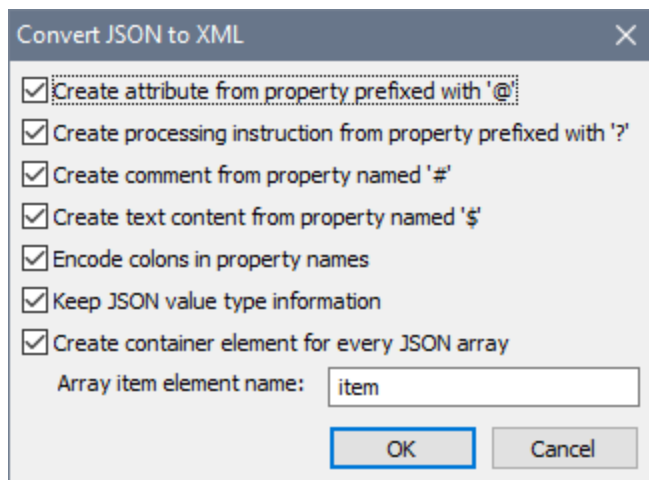

Note the following points:

- JSON/YAML object properties are converted to XML elements. The first options in the dialog enable you to choose whether some types of properties are created or not.
- *Encode colons in property names*: If selected, colons in JSON/YAML names are encoded and not created as colons. If not selected, colons are left as is.
- *Keep JSON value type information*: If selected, a property's JSON type information is created as an attribute-value pair of the corresponding element.
- *Create container element for every JSON array*: The container element in the XML document will be given the name of the JSON array object. The items of the JSON array are created as XML elements within this container. Each is given the name you specify in the *Array item element name* text box.

25.11.10 Convert XML Schema to/from JSON Schema

If the active document is an XML Schema, this command generates a JSON schema document from the XML schema. If the active document is a JSON schema, the command generates an XML Schema from the JSON schema. The generated document is opened in a new window, and can then be saved to any location. Conversion options are described below. For more information about JSON and JSON editing support in XMLSpy, see the section [JSON and JSON Schema](#)⁵⁰⁷.

XML Schema to JSON Schema conversion options

When you click the **Convert XML Schema to/from JSON Schema** command to convert an XML Schema document to a JSON schema, the Convert XML Schema to JSON Schema dialog (*screenshot below*) appears. Select the [JSON Schema version](#)⁵²⁴ you want and the conversion options, and click **OK**. A JSON schema will be generated from the XML Schema, and the generated document will be opened in a new window.

The general conversion strategy is this: (i) XML Schema simple types are mapped to JSON Schema simple types (such as string and number); (ii) XML Schema complex types are mapped to JSON objects.

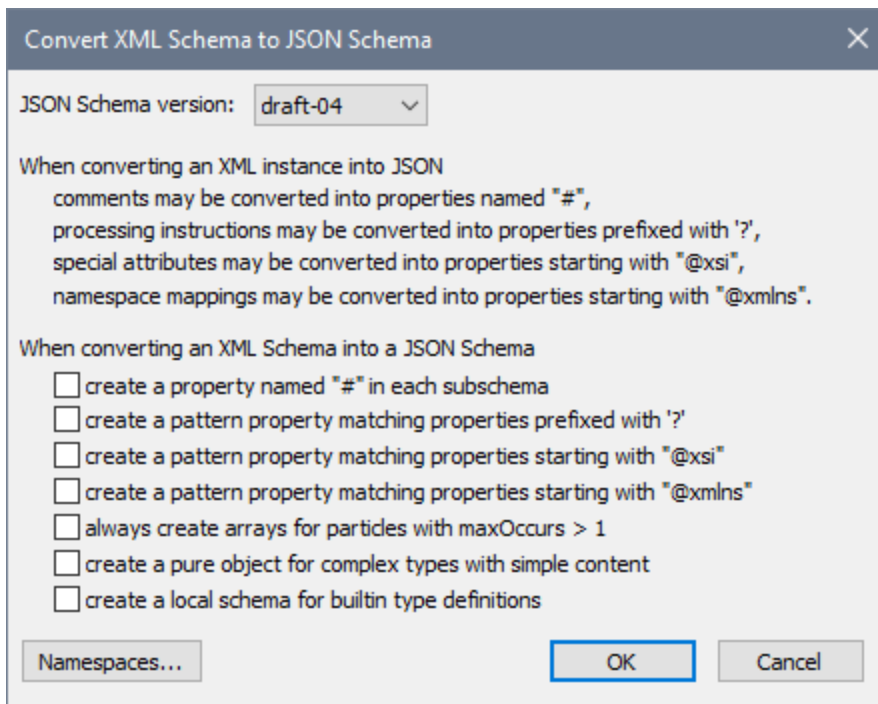

The top part of the dialog provides information about how certain XML Schema components are converted. The bottom part of the dialog provides the following options:

- *Create a property named "#" in each subschema*: If selected, a property with this name is created in each JSON schema definition.
- *Create pattern properties matching properties prefixed with '?', "@xsi", "@xmlns"*: Specifies, for each of these prefixes, a pattern property to match properties with names that have these prefixes. For more information about pattern properties, see the section [JSON Objects and Properties](#)⁵³³.
- *Always create arrays for particles with maxOccurs > 1*: In XML Schema, particles are the elements of complex content models. If the number of occurrences is more than one, then the particles are defined as an array in JSON Schema. Otherwise, they are defined as properties of a JSON object.
- *Create a pure object for complex types with simple content*: XML Schema's complex type with simple content is a type that allows attributes and text content, but no child elements. If the *Create pure object* option is selected, then the complex type is converted to a JSON object. The type's attributes are converted to properties of the JSON object, where the property names are prefixed with @. For the type's text content, a property named § is generated. If the *Create pure object* option is not selected, then the complex type is converted into an object that may contain other objects and JSON simple types such as string and number.

- *Create a local schema for built-in type definitions:* If selected, this option creates the type definition in the object itself. Otherwise, the type definition is a reference to a separate object. The two output cases are shown in the JSON Schema code fragments below.

Type definition is referenced:

```
"properties": {
  "AccountManager": {
    "$ref": "#/definitions/xs:string"
  }
}
"xs:string": {
  "type": "string"
}
```

Type definition is local:

```
"properties": {
  "AccountManager": {
    "type": "string"
  }
}
```

JSON Schema to XML Schema conversion options

When you click the **Convert XML Schema to/from JSON Schema** command to convert a JSON Schema document to an XML schema, the Convert JSON Schema to XML Schema dialog (*screenshot below*) appears. Set the conversion options you want, and click **OK**. An XML schema will be generated from the JSON Schema, and the generated document will be opened in a new window.

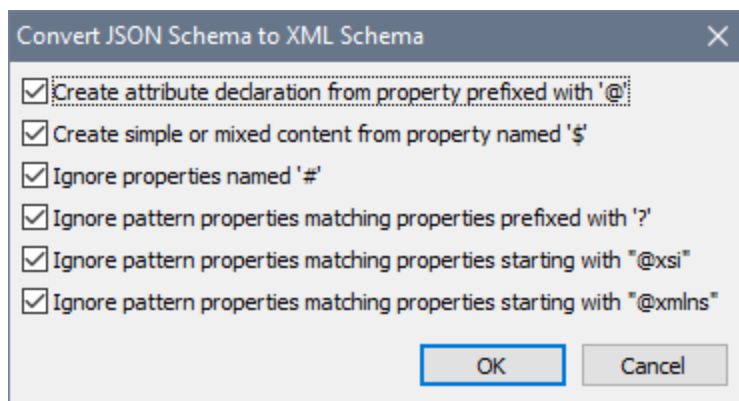

You can select the following options:

- Whether JSON property names that begin with '@' and '\$' are created or not. They would be created, respectively, as attribute nodes and text nodes.
- Whether properties named '#' are created, as XML comment nodes, or not.
- Whether pattern properties that match properties prefixed with '?', '@xsi', and/or '@xmlns' are ignored or not. If not ignored, then the properties prefixed with '?', '@xsi', and '@xmlns' are

converted, respectively, to processing instructions, `xsi:` prefixed attributes, and `xmlns:` prefixed attributes.

25.11.11 Convert JSON to/from YAML

Make the JSON or YAML file you want to convert to the other format the active file and select the **Convert JSON to/from YAML** command. The active file will be converted into the document of the other format and will be opened in a new window. You can save the document to file from this window.

Note: This command is also available in the context menu of [XMLSpy project](#)⁷¹⁴ folders and files. When used on a project folder, the command allows you to batch convert all the JSON files or all the YAML files in the folder.

25.12 View Menu

The **View** menu (*screenshot below*) controls the display of the active [Main window](#)¹⁰⁸ and allows you to change the way the document is displayed.

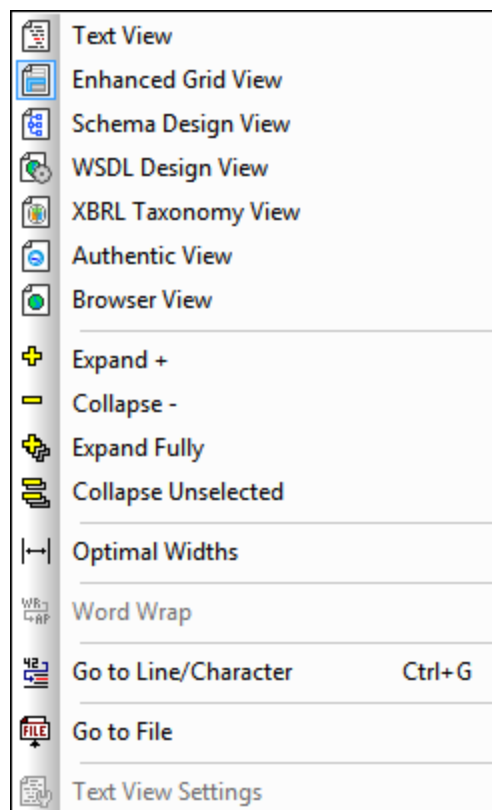

This section provides a description of commands in the **View** menu.

25.12.1 Text View



This command switches the current view of the document to [Text View](#)¹³⁰, which enables you to edit the document in its text form. It supports a number of advanced text editing features, described in detail in [Text View](#)¹³⁰ section of this document.

Note: You can configure aspects of Text View in various tabs of the Options dialog ([Tools | Options](#)¹⁰⁴⁰).

25.12.2 Enhanced Grid View



This command switches the current document into [Grid View](#)¹⁴⁶. If the previous view was [Text View](#)¹³⁰, the document is automatically checked for well-formedness.

| XML | <?xml version="1.0" encoding="UTF-8"?> | | | | | | | | | | | | | | | | | | | | | | | | | | | | | | | | | | |
|--------------------|--|--------|------------|--------|--|----------|---------------------------------|--------|------------|-------|-----------|---|----|------|--------|--------------------|---|------|-------|-------|------|--------|----|-------|------|-----|-------|--|--|--|-------|-------|--|--|--|
| Company | <table border="1"> <tr><td>xmlns</td><td colspan="4">http://my-company.com/namespace</td></tr> <tr><td>xmlns:xsi</td><td colspan="4">http://www.w3.org/2001/XMLSchema-instance</td></tr> <tr><td>xsi:schemaLocation</td><td colspan="4">http://my-company.com/namespace AddressLast.xsd</td></tr> </table> | | | | | xmlns | http://my-company.com/namespace | | | | xmlns:xsi | http://www.w3.org/2001/XMLSchema-instance | | | | xsi:schemaLocation | http://my-company.com/namespace AddressLast.xsd | | | | | | | | | | | | | | | | | | |
| xmlns | http://my-company.com/namespace | | | | | | | | | | | | | | | | | | | | | | | | | | | | | | | | | | |
| xmlns:xsi | http://www.w3.org/2001/XMLSchema-instance | | | | | | | | | | | | | | | | | | | | | | | | | | | | | | | | | | |
| xsi:schemaLocation | http://my-company.com/namespace AddressLast.xsd | | | | | | | | | | | | | | | | | | | | | | | | | | | | | | | | | | |
| Address | <table border="1"> <tr><td>xsi:type</td><td colspan="4">US-Address</td></tr> <tr><td>Name</td><td colspan="4">US dependency</td></tr> <tr><td>Street</td><td colspan="4">Noble Ave.</td></tr> <tr><td>City</td><td colspan="4">Dallas</td></tr> <tr><td>Zip</td><td colspan="4">04812</td></tr> <tr><td>State</td><td colspan="4">Texas</td></tr> </table> | | | | | xsi:type | US-Address | | | | Name | US dependency | | | | Street | Noble Ave. | | | | City | Dallas | | | | Zip | 04812 | | | | State | Texas | | | |
| xsi:type | US-Address | | | | | | | | | | | | | | | | | | | | | | | | | | | | | | | | | | |
| Name | US dependency | | | | | | | | | | | | | | | | | | | | | | | | | | | | | | | | | | |
| Street | Noble Ave. | | | | | | | | | | | | | | | | | | | | | | | | | | | | | | | | | | |
| City | Dallas | | | | | | | | | | | | | | | | | | | | | | | | | | | | | | | | | | |
| Zip | 04812 | | | | | | | | | | | | | | | | | | | | | | | | | | | | | | | | | | |
| State | Texas | | | | | | | | | | | | | | | | | | | | | | | | | | | | | | | | | | |
| Person (3) | <table border="1"> <thead> <tr> <th></th> <th>Manager</th> <th>Degree</th> <th>Programmer</th> <th>First</th> </tr> </thead> <tbody> <tr> <td>1</td> <td>false</td> <td>MA</td> <td>true</td> <td>Alfred</td> </tr> <tr> <td>2</td> <td>true</td> <td>Ph.D</td> <td>false</td> <td>Colin</td> </tr> <tr> <td>3</td> <td>true</td> <td>BA</td> <td>false</td> <td>Fred</td> </tr> </tbody> </table> | | | | | | Manager | Degree | Programmer | First | 1 | false | MA | true | Alfred | 2 | true | Ph.D | false | Colin | 3 | true | BA | false | Fred | | | | | | | | | | |
| | Manager | Degree | Programmer | First | | | | | | | | | | | | | | | | | | | | | | | | | | | | | | | |
| 1 | false | MA | true | Alfred | | | | | | | | | | | | | | | | | | | | | | | | | | | | | | | |
| 2 | true | Ph.D | false | Colin | | | | | | | | | | | | | | | | | | | | | | | | | | | | | | | |
| 3 | true | BA | false | Fred | | | | | | | | | | | | | | | | | | | | | | | | | | | | | | | |

25.12.3 Schema Design View



This command switches the current document, if it is an XML Schema document, to Schema Design View. For a detailed description of mechanisms available in this view, see the [Schema View](#)¹⁹⁸ section of this documentation.

25.12.4 Authentic View

This command switches the current document to [Authentic View](#)⁴⁵⁹.

Authentic View enables you to edit XML documents based on StyleVision Power Stylesheet templates created in Altova's StyleVision application. These templates (StyleVision stylesheets or SPS files) display XML documents in a graphical format that makes editing the XML document easier (than editing it in a text format with markup).

If an XML document is associated with an SPS file ([Authentic | Assign a StyleVision Stylesheet](#)⁹²²), the XML document can be viewed in Authentic View. You can also open an SPS file as a new empty template in Authentic View, in one of two ways:

- Select the **File | New** command and then click the **Select a StyleVision stylesheet** button.
- Select the **Authentic | New Document** command and then browse for the SPS file.

See the [Authentic View](#)⁴⁴⁴ and StyleVision documentation for more information.

25.12.5 Browser View



This command switches the current document to [Browser View](#)²⁷⁶. An XML-enabled browser renders the XML document using information from available CSS and/or XSL stylesheets.

When switching to Browser View, the document is first checked for validity if the *Validate upon saving* option in the [File section of the Options dialog](#)¹⁰⁴¹ (**Tools | Options**) is checked. For more information, see the [Browser View](#)²⁷⁶ section of this documentation.

25.12.6 Expand



This command (*shortcut*: numeric pad '+') is enabled in Grid View and expands the selected element one level. The element remains selected after expansion, so you can expand the element additional levels by repeatedly clicking the shortcut '+' key.

25.12.7 Collapse



This command (*shortcut*: numeric pad '-') is enabled in Grid View and collapses the selected element one level. You can expand or collapse any element by clicking the gray bar to the left of the element.

25.12.8 Expand Fully



This command (*shortcut*: * or x on the numeric keypad) is enabled in Grid View and in Text View if the Text View folding margin is active. It expands all descendant nodes of the selected element.

25.12.9 Collapse Unselected



This command (*shortcut*: **Ctrl** + numeric pad '-') is enabled in Grid View and keeps the selected item uncollapsed while collapsing all other items. This helps maximize focus on one element and its children while reducing the focus on other nodes.

25.12.10 Optimal Widths



This command is enabled in Grid View and adjusts the widths of all columns in Grid View so that each column has a width that exactly accommodates in one line the longest text string in any of its cells. A maximum optimal width can be specified in the View section of the Options dialog (**Tools | Options**). Note that optimal widths are calculated on the basis of the visible cells of columns. This enables the optimization of the view when individual elements are collapsed or expanded.

25.12.11 Word Wrap



This command enables or disables word wrapping in Text View. When word-wrapping is toggled on, text will wrap at the window's edge.

25.12.12 Go to Line/Character



This command (*shortcut: **Ctrl+G***) is enabled in Text View and Grid View. It pops up a dialog (*screenshot below*) in which you can enter the line number and character number to go to. In Text View, the cursor will jump to the position you entered. In Grid View, the node closest to the line and/or character number you entered will be highlighted.

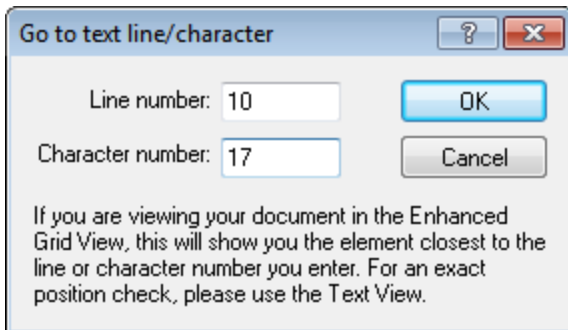

This feature is useful when you need to quickly navigate to a location, for example, when the location of an error is given in an error message.

25.12.13 Go to File



This command is enabled in Text View and Grid View. When the cursor is placed inside text that references a file (in Text View) or in a node (in Grid View) that contains text referencing a file, the referenced document is opened. It opens a document that is being referred to, from within the file you are currently editing.

25.12.14 Text View Settings



The **Text View Settings** command is enabled in Text View. It opens the Text View Settings dialog (*screenshot below*), in which you can configure Text View. A shortcut icon  to open the dialog is available in the Text toolbar.

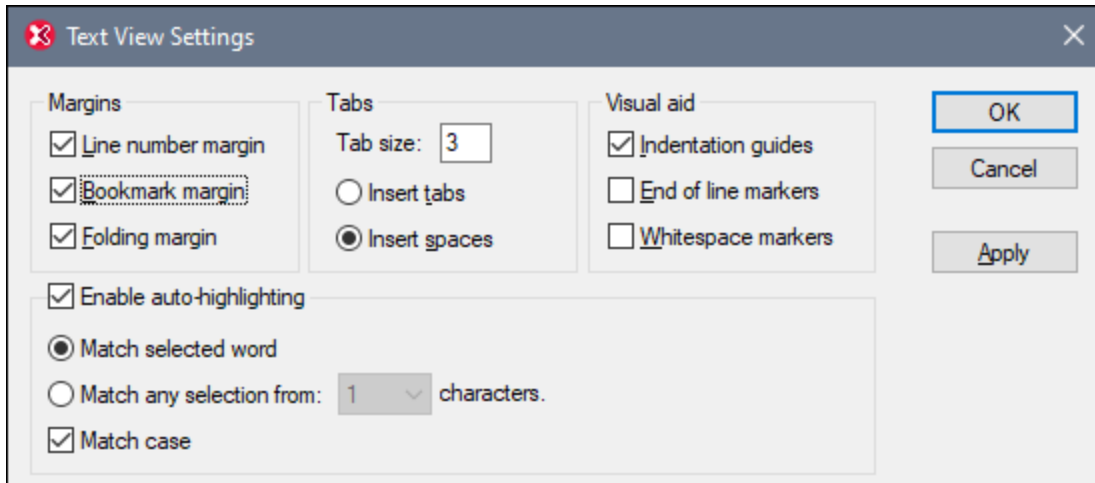

Margins

In the Margins pane, the Line Number, Bookmark, and Source Folding margins can be toggled on and off. Each of these is a separate margin in Text View and displays, respectively: (i) line numbers, (ii) bookmarks, and (ii) source folding icons to expand/collapse nodes. The settings of the Margins pane determine whether the margins are displayed in Text View or not. Bookmark commands are in the **Edit** menu. You can expand and collapse nodes in Text View only if the *Folding margin* setting is toggled on.

Tabs

The Tab pane enables you to set the tab size in terms of spaces. The radio buttons below the *Tab size* setting determine whether documents are displayed with tab or space indentation when pretty-printing-with-indentation is enabled in the [View section of the Options dialog](#) ([Tools | Options](#)).

Visual Aid

The Visual Aid pane contains settings to toggle on indentation guides (tab-distanced vertical lines that show the indentation of the text; see *screenshot below*), end-of-line markers, and whitespace markers (tabs and space characters). (Tabs are indicated with arrows, while spaces are indicated with dots (*both pink in the screenshot below*). The colors of whitespace markers can be customized in the [Text View options of the Options dialog](#).)

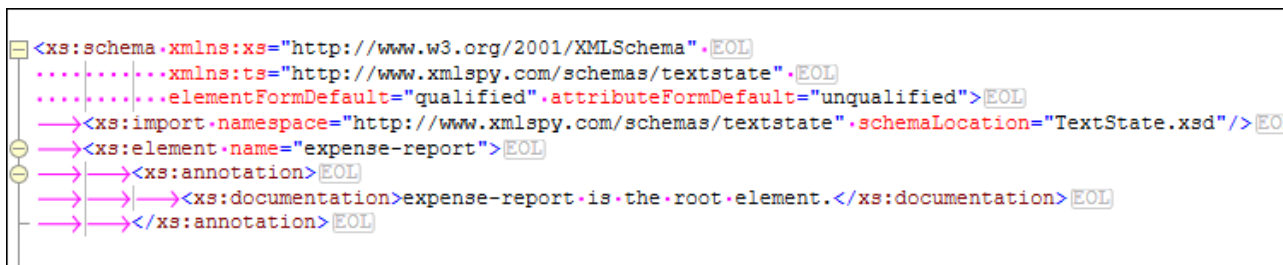

Enable auto-highlighting

If highlighting is enabled, then all occurrences of a selection in Text View are highlighted. What constitutes a selection can be set via the options in this pane. A selection can be defined to be an entire word or a fixed number of characters, with the text-casing counting or not counting for a match. For a character selection, you can specify the minimum number of characters to match (for example, two or more characters). In Text View, all occurrences of character sequences that match your selection will be highlighted. For word searches, element names, attribute names, attribute values without quotes, and the angular brackets of element tags are considered to be separate words.

Key map

The key map is a list of XMLSpy shortcuts and their associated commands.

25.13 Browser Menu

The **Browser** menu commands are enabled in [Browser View](#)²⁷⁶ only. The **Back** and **Forward** commands, however, are additionally enabled in Schema View.

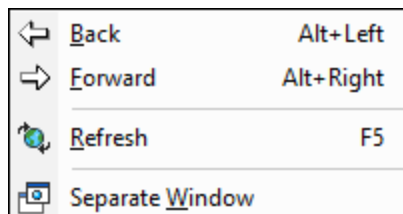

Back, Forward

The **Back** command (*shortcut: Alt + Left arrow*) is enabled in Browser View and Schema View.

- In Browser View, it displays the previously viewed page. The **Backspace** key achieves the same effect. The command is useful if you click a link in your XML document and then want to return to your XML document.
- In Schema View, it takes you back through previously viewed components or views. It can take you to as many as 500 previously viewed positions.

The **Forward** command (*shortcut: Alt + Right arrow*) is enabled in Browser View and Schema View.

- In Browser View, it moves you forward through previously viewed pages.
- In Schema View, it takes you forward through previously viewed components or views. It can take you to as many as 500 previously viewed positions.

Refresh

The **Refresh (F5)** command is enabled in Browser View and updates Browser View by reloading the current document and documents related to the current document (such as CSS and XSL stylesheets, and DTDs).

Separate Window

The **Separate Window** command is enabled in Browser View and undocks Browser View from the application window. As a separate window, Browser View can be displayed side-by-side with an editing view of the document.

To refresh the separated Browser View after making a change in an editing view, press **F5** in the editing view. To dock a separate Browser View window back into the application window, make the Browser View window active and click the **Separate Window** command.

25.14 Tools Menu

The Tools menu allows you to:

- Check the [spelling](#)¹⁰⁰⁰ of your XML documents
- Access the [scripting environment](#)¹⁰⁹² of XMLSpy. You can create, manage and store your own forms, macros and event handlers
- [View](#)¹⁰⁰⁷ the currently assigned macros
- Compare any two files to check for differences
- Compare any two folders to check for differences
- Access customized commands that use external applications. These commands can be created in the [Tools tab of the Customize dialog](#)¹⁰²⁶ ..
- [Define global resources](#)¹⁰¹⁷
- [Change the active configuration](#)¹⁰¹⁸ for global resources in XMLSpy
- [Add RaptorXML Servers](#)¹⁰¹⁹ for XML and XBRL validation, and to [configure RaptorXML validation options](#)¹⁰²⁰
- [Select a Raptor Server configuration](#)¹⁰²² as the active configuration
- [Customize](#)¹⁰²² your version of XMLSpy: define your own toolbars, keyboard shortcuts, menus, and macros
- Define global XMLSpy [settings](#)

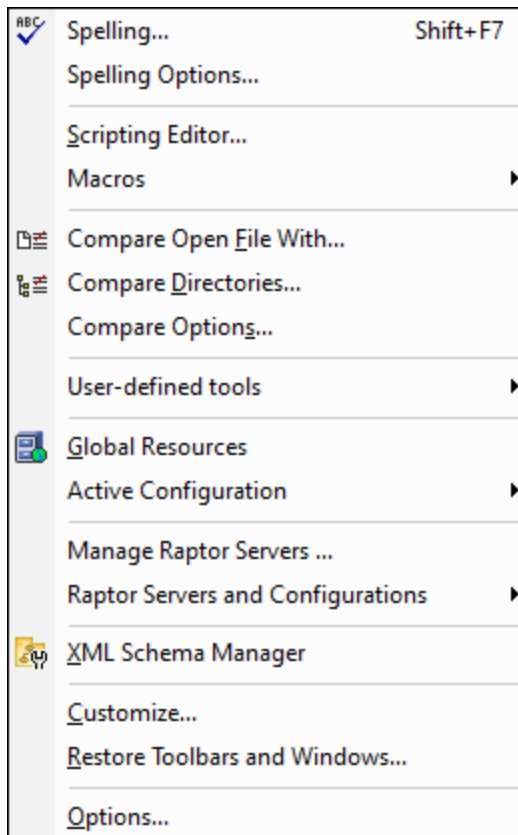

25.14.1 Spelling

XMLSpy's spellchecker with built-in language dictionaries (*see note below*) is enabled in Text View, Grid View, and Authentic View. If you wish to spellcheck a document that you have been editing in another view, you can switch to Text View or Grid View and run a spelling check. For example, if you have been editing an XML Schema document in Schema View, switch to Text View or Grid View for the spelling check.

Note: The built-in dictionaries that ship with Altova software do not indicate any language preferences by Altova. The selection of dictionaries is based on the availability of dictionaries that permit redistribution with commercial software, such as the [MPL](#), [LGPL](#), or [BSD](#) licenses. Many other open-source dictionaries exist, but are distributed under more restrictive licenses, such as the [GPL](#) license. Many of these dictionaries are available as part of a separate installer located at <http://www.altova.com/dictionaries>. You should choose the dictionaries you want to use on the basis of their license and their usefulness to you.

This section describes how to use the spellchecker. It is organized into the following sub-sections:

- [Selecting the spellchecker language](#)¹⁰⁰⁰
- [Defining the scope of the check](#)¹⁰⁰¹
- [Running the spelling check](#)¹⁰⁰¹

Selecting the spellchecker language

The spellchecker language can be set as follows:

1. Click the **Tools | Spelling Options** menu command.
2. In the Spelling Options dialog that appears (*screenshot below*), select one of the installed dictionaries from the dropdown list of the Dictionary Language combo box.

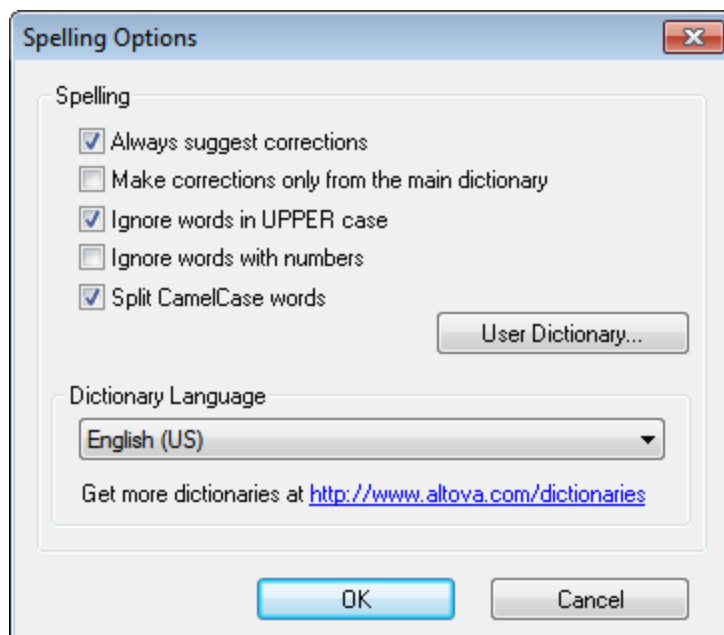

3. Click **OK** to finish.

The dictionary language you selected will be used by the spellchecker for spelling checks. If the language you want is not already installed, you can download additional language dictionaries. How to do this is described in the section, [Adding dictionaries for the spellchecker](#)¹⁰⁰⁵.

Defining the scope of the check

When the spellchecker is run in Text View or Grid View, the scope of the check can be defined immediately before starting the check. Do this by selecting the command **Tools | Spelling Options** and by defining the required scope in the [XML Spelling Options dialog](#)¹⁰⁰³ that pops up (see screenshot below).

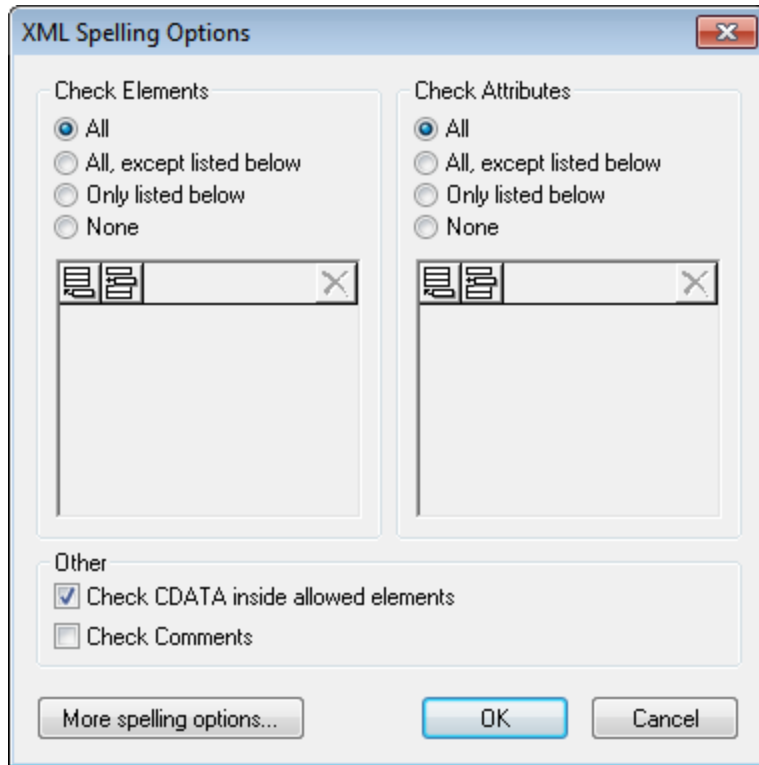

You can select which elements and attributes are to be checked and whether CDATA sections and comments should be checked. Also see the description of the [Spelling Options](#)¹⁰⁰³ command for related information.

Running the spellchecker

The **Tools | Spelling (Shift+F7)** command automatically starts checking the currently active XML document according to the [defined scope](#)¹⁰⁰¹. If an unknown word is encountered, the *Spelling: Not in Dictionary* dialog pops up (screenshot below). Otherwise the spelling check runs through to completion.

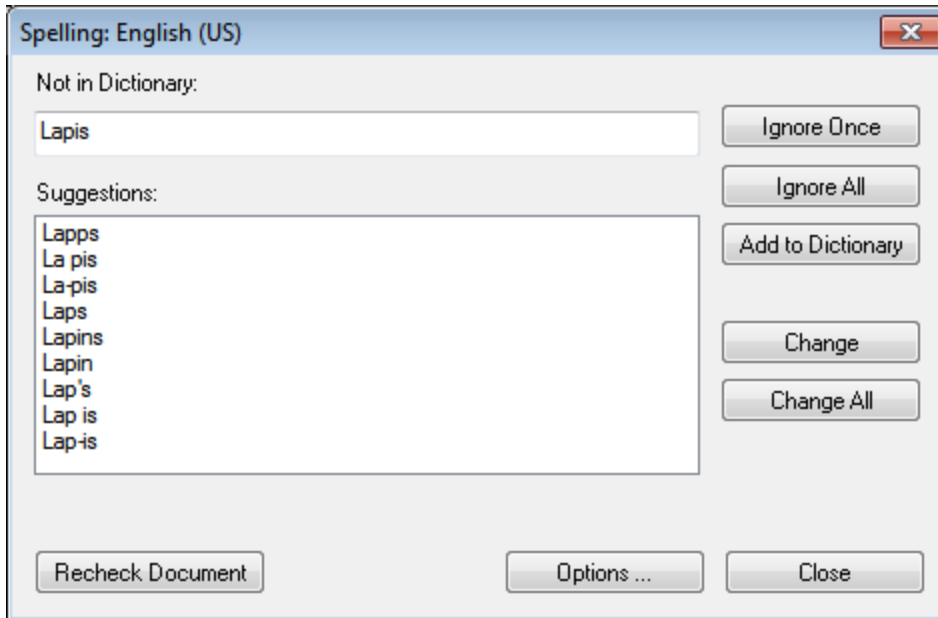

The various parts of the *Spelling: Not in Dictionary* dialog and the available options are described below:

Not in Dictionary

This text box contains the word that cannot be found in either the selected language dictionary or user dictionary. The following options are available:

- You can edit the word in the text box manually or select a suggestion from the *Suggestions* pane. Then click **Change** to replace the word in the XML document with the edited word. (Double-clicking a suggestion inserts it directly in the XML document.) When a word is shown in the *Not in Dictionary* text box, it is also highlighted in the XML document, so you can edit the word directly in the document if you like. Clicking **Change All** will replace all occurrences of the word in the XML document with the edited word.
- You can choose to not make any change and to ignore the spellchecker warning—either just for the current occurrence of the word or for every occurrence of it.
- You can add the word to the user dictionary and so allow the word to be considered correct for all checks from the current check onwards.

Suggestions

This list box displays words resembling the unknown word (supplied from the language and user dictionaries). Double-clicking a word in this list automatically inserts it in the document and continues the spellchecking process.

Ignore once

This command allows you to continue checking the document while ignoring the first occurrence of the unknown word. The same word will be flagged again if it appears in the document.

Ignore all

This command ignores all instances of the unknown word in the whole document.

Add to dictionary

This command adds the unknown word to the **user dictionary**. You can access the user dictionary (in order to edit it) via the [Spelling Options](#)¹⁰⁰⁶ dialog.

Change

This command replaces the currently highlighted word in the XML document with the (edited) word in the *Not in Dictionary* text box.

Change all

This command replaces all occurrences of the currently highlighted word in the XML document with the (edited) word in the *Not in Dictionary* text box.

Recheck Document

The **Recheck Document** button restarts the check from the beginning of the document.

Options

Clicking the **Options** button opens a dialog box depending on the current view.

- If the current view is Authentic View, the [Spelling Options](#)¹⁰⁰³ dialog box is opened.
- If the current view is Text View or Grid View, then the [XML Spelling Options](#)¹⁰⁰³ dialog box is opened.

For more information about these dialog boxes, see the section [Spelling Options](#)¹⁰⁰³.

Close

This command closes the Spelling dialog box.

25.14.2 Spelling Options

The **Tools | Spelling Options** command opens the [Spelling Options](#)¹⁰⁰⁴. Depending on which view is active, the **Tools | Spelling Options** command opens either the [Spelling Options](#)¹⁰⁰⁴ dialog directly (Schema View, Authentic View, Browser View), or the [XML Spelling Options](#)¹⁰⁰³ dialog (Text View, Grid View,). The XML Spelling Options dialog has a **Spelling Options** button to access the Spelling Options dialog.

The various settings available in these two dialogs are described in the sub-sections of this section:

- [Spelling check context](#)¹⁰⁰³
- [Spelling options](#)¹⁰⁰⁴
- [Adding dictionaries for the spellchecker](#)¹⁰⁰⁵
- [Working with the user dictionary](#)¹⁰⁰⁶

XML Spelling Options dialog

Clicking the **Tools | Spelling Options** command in Text View or Grid View opens the XML Spelling Options dialog (*screenshot below*), in which you can select the scope of the spelling check. You can select which elements and attributes are to be checked and whether CDATA sections and comments should be checked.

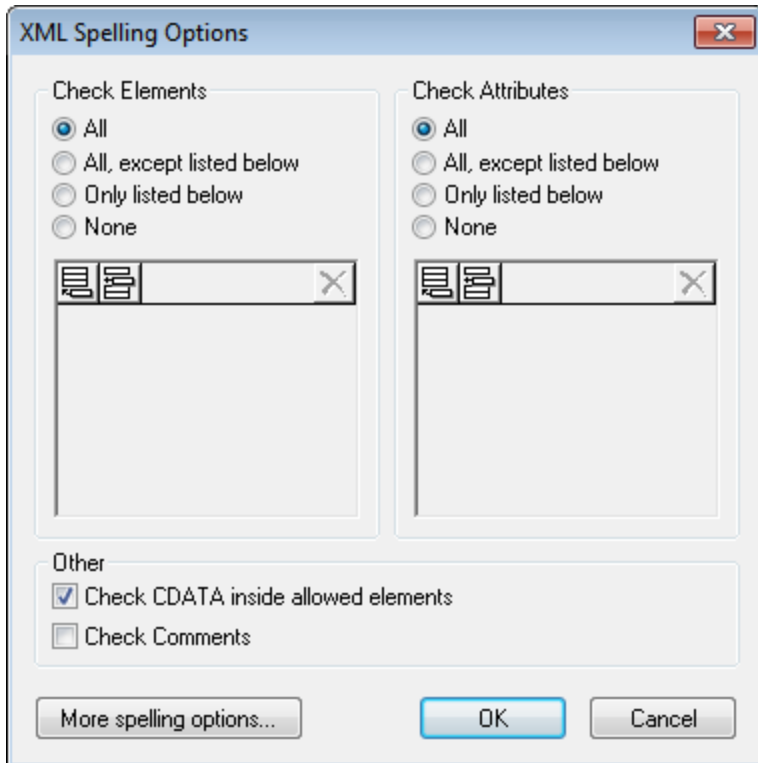

You can compile a list of elements and/or attributes that you wish to have spellchecked or have excluded from the spelling check. Alternatively, you can choose to run the spelling check on all elements and/or attributes or on no element or attribute.

Clicking the **More Spelling Options** button at the bottom of the dialog opens the Spelling Options dialog.

Spelling options

The Spelling Options dialog is used to define global spellchecker options.

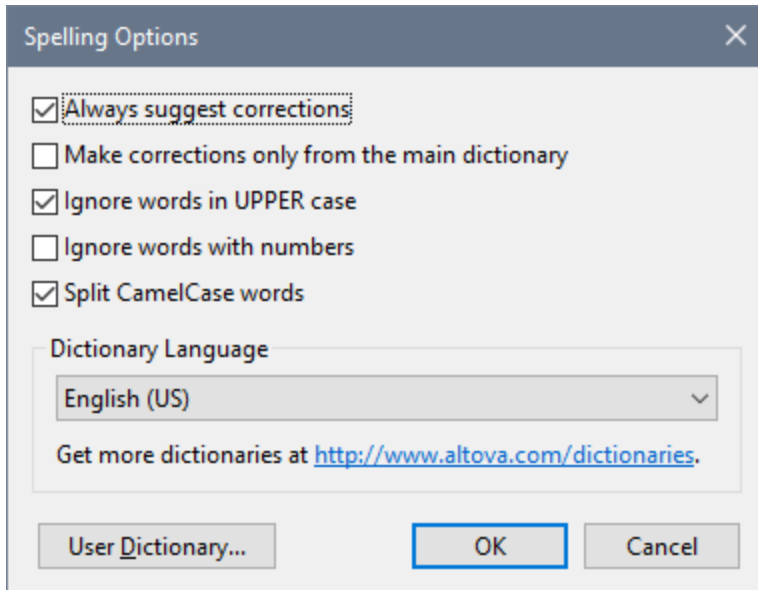

Always suggest corrections:

Activating this option causes suggestions (from both the language dictionary and the user dictionary) to be displayed in the Suggestions list box. Disabling this option causes no suggestions to be shown.

Make corrections only from main dictionary:

Activating this option causes only the language dictionary (main dictionary) to be used. The user dictionary is not scanned for suggestions. It also disables the **User Dictionary** button, preventing any editing of the user dictionary.

Ignore words in UPPER case:

Activating this option causes all upper case words to be ignored.

Ignore words with numbers:

Activating this option causes all words containing numbers to be ignored.

Split CamelCase words

CamelCase words are words that have capitalization within the word. For example the word "CamelCase" has the "C" of "Case" capitalized, and is therefore said to be CamelCased. Since CamelCased words are rarely found in dictionaries, the spellchecker would flag them as errors. To avoid this, the *Split CamelCase words* option splits CamelCased words into their capitalized components and checks each component individually. This option is checked by default.

Dictionary Language

Use this combo box to select the dictionary language for the spellchecker. The default selection is US English. Other language dictionaries are available for download free of charge from the [Altova website](http://www.altova.com/dictionaries).

Adding dictionaries for the spellchecker

For each dictionary language there are two Hunspell dictionary files that work together: a .aff file and .dic file. All language dictionaries are installed in a `Lexicons` folder at the following location: `C:`

```
\ProgramData\Altova\SharedBetweenVersions\SpellChecker\Lexicons.
```

Within the `Lexicons` folder, different language dictionaries are each stored in a different folder: `<language name>\<dictionary files>`. For example, files for the two English-language dictionaries (English (British) and English (US)) will be stored as below:

```
C:\ProgramData\Altova\SharedBetweenVersions\SpellChecker\Lexicons\English (British)
\en_GB.aff
C:\ProgramData\Altova\SharedBetweenVersions\SpellChecker\Lexicons\English (British)
\en_GB.dic
C:\ProgramData\Altova\SharedBetweenVersions\SpellChecker\Lexicons\English (US)\en_US.aff
C:\ProgramData\Altova\SharedBetweenVersions\SpellChecker\Lexicons\English (US)\en_US.dic
```

In the Spelling Options dialog, the dropdown list of the *Dictionary Language* combo box displays the language dictionaries. These dictionaries are those available in the `Lexicons` folder and have the same names as the language subfolders in the `Lexicons` folder. For example, in the case of the English-language dictionaries shown above, the dictionaries would appear in the Dictionary Language combo box as: *English (British)* and *English (US)*.

All installed dictionaries are shared by the different users of the machine and the different major versions of Altova products (whether 32-bit or 64-bit).

You can add dictionaries for the spellchecker in two ways, neither of which require that the files be registered with the system:

- By adding Hunspell dictionaries into a new subfolder of the `Lexicons` folder. Hunspell dictionaries can be downloaded, for example, from <https://wiki.openoffice.org/wiki/Dictionaryes> or <http://extensions.services.openoffice.org/en/dictionaries>. (Note that OpenOffice uses the zipped `OXT` format. So change the extension to `.zip` and unzip the `.aff` and `.dic` file to the language folders in the `Lexicons` folder. Also note that Hunspell dictionaries are based on Myspell dictionaries. So Myspell dictionaries can also be used.)
- By using the [Altova dictionary installer](#), which installs a package of multiple language dictionaries by default to the correct location on your machine. The installer can be downloaded via the link in the Dictionary language pane of the Spelling Options dialog (see *screenshot below*). Installation of the dictionaries must be done with administrator rights, otherwise installation will fail with an error.

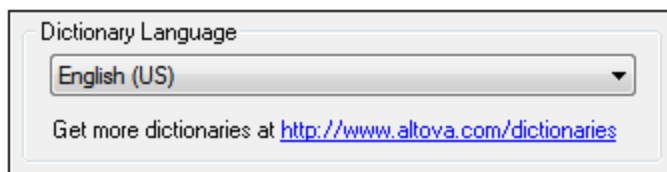

Note: It is your choice as to whether you agree to the terms of the license applicable to the dictionary and whether the dictionary is appropriate for your use with the software on your computer.

Working with the user dictionary

Each user has one user dictionary, in which user-allowed words can be stored. During a spellcheck, spellings are checked against a word list comprising the words in the language dictionary and the user dictionary. You can add words to and delete words from the user dictionary via the User Dictionary dialog (*screenshot below*). This dialog is accessed by clicking the User Dictionary button in the Spelling Options dialog (see *second screenshot in this section*).

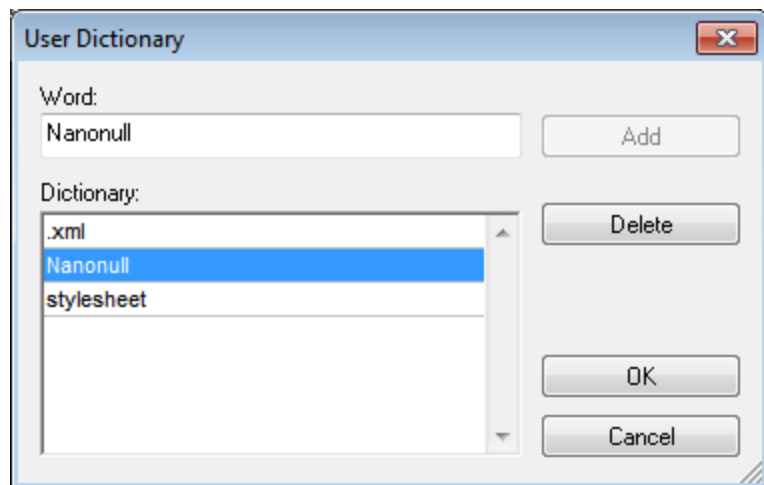

To add a word to the user dictionary, enter the word in the Word text box and click **Add**. The word will be added to the alphabetical list in the Dictionary pane. To delete a word from the dictionary, select the word in the Dictionary pane and click **Delete**. The word will be deleted from the Dictionary pane. When you have finished editing the User Dictionary dialog, click **OK** for the changes to be saved to the user dictionary.

Words may also be added to the User Dictionary during a spelling check. If an unknown word is encountered during a spelling check, then the [Spelling dialog](#)¹⁰⁰⁰ pops up prompting you for the action you wish to take. If you click the **Add to Dictionary** button, then the unknown word is added to the user dictionary.

The user dictionary is located at: `C:\Users\\Documents\Altova\SpellChecker\Lexicons\user.dic`

25.14.3 Scripting Editor

The **Scripting Editor** command opens the Scripting Editor window. How to work with the Scripting Editor is described in the [Scripting section](#)¹⁰⁹² of this documentation.

Note: The .NET Framework version 2.0 or higher will have to be installed on your machine in order for the Scripting Editor to run.

25.14.4 Macros

Mousing over the **Macros** command rolls out a submenu containing the macros defined in the Scripting Project that is currently active in XMLSpy (*screenshot below*).

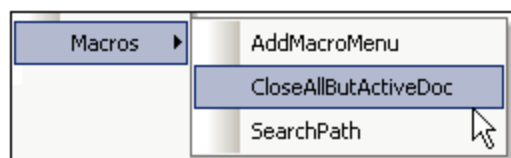

Clicking a macro in the submenu (see *screenshot above*) runs the macro.

25.14.5 Comparisons

XMLSpy provides a comparison (or differencing) feature, with which you can compare XML and Text files, as well as folders, in order to check for differences.

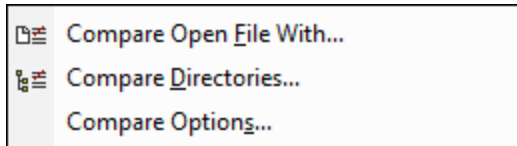

There are the following menu items in the **Tools** menu that enable you to perform comparison tasks on files and folders:

- [Compare open file with](#) ¹⁰⁰⁸
- [Compare directories](#) ¹⁰¹²
- [Compare options](#) ¹⁰¹⁵

These commands are described in detail in the following sub-sections.

25.14.5.1 Compare Open File With

This command allows you to compare the open file with another file. The comparison shows the files to compare tiled vertically in the main window with the differences between them highlighted in each file. If a difference is between two files, then the difference is highlighted in green. If content is different across three files (*available in the Enterprise Edition only*), then this is referred to as a conflict, and the conflict is highlighted in pink. You can compare files as XML documents (where the structure and semantics of tags is significant) or as text documents.

Note: Three-way file comparisons are available in the **Enterprise Edition only**.

To compare the active file (in the GUI) with another file, do the following:

1. With the file to compare active in the Main Window (only one open file can be active at a given time), click **Tools | Compare open file with**. A Browse dialog appears (*screenshot below*), in which you can browse for one or two files to compare with the active file.

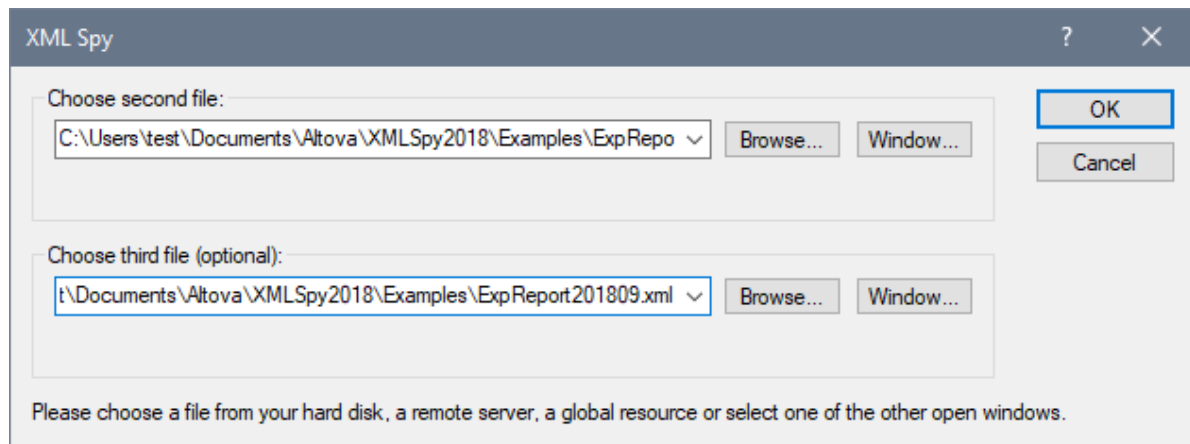

2. Click **Browse** ⁷⁸⁷ to select a file via file explorer, a global resource, or a URL. Click **Window** to select a file that is open in one of the windows of XMLSpy.
3. Click **OK**. The Settings dialog appears (*screenshot below*). These settings are described in the topic [Compare Options](#) ¹⁰¹⁵. If you wish to not have this dialog appear each time you start a compare session, uncheck *Show settings before starting compare* (located at the bottom of the dialog).

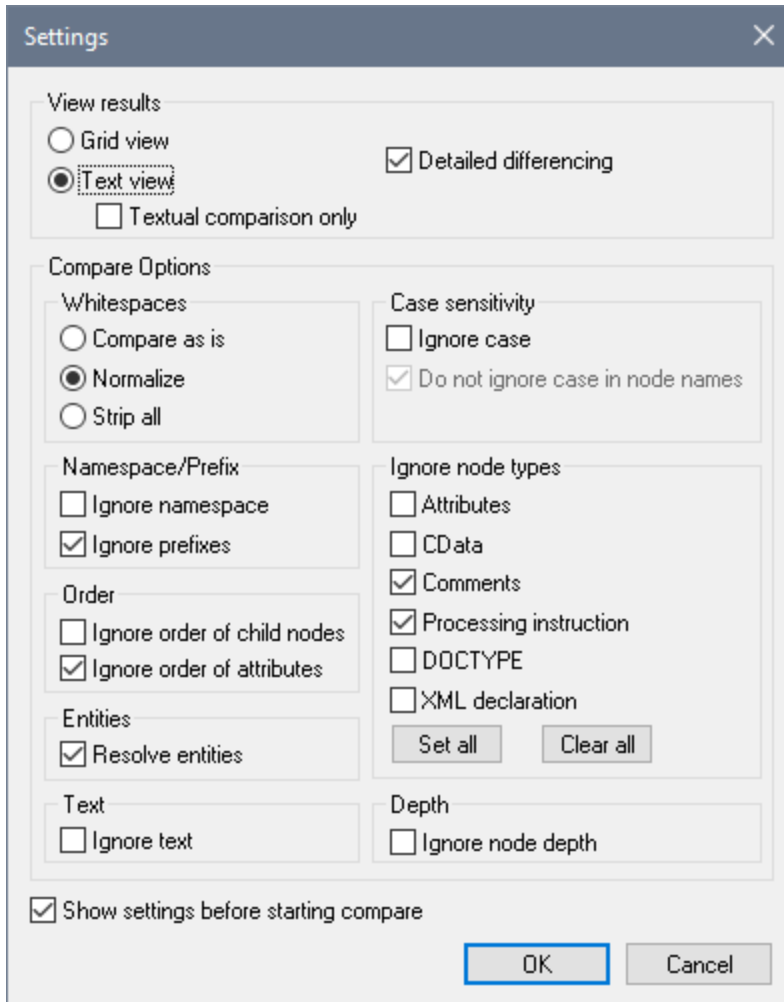

4. Select the required settings, then click **OK**. Two things happen: (i) The files to compare are displayed side-by-side in separate panes; (ii) The Compare Files control window appears. (*Screenshots in next section, [File Comparisons](#)¹⁰¹⁰.*)
5. You can navigate and merge differences by using the buttons in the Compare Files control window. (*For usage information, see the next section, [File Comparisons](#)¹⁰¹⁰.*)
6. When you finish reviewing and/or merging differences, click **Done**.

Note: Compare settings can be changed during a Compare session (by selecting [Tools | Compare options](#)¹⁰¹⁵), but will only take effect from the next Compare session onward; the new settings will not affect the current session.

File comparisons and merging of differences

There are two types of comparison:

- *Two-way comparison:* Two files are compared. The file that was active (when comparison was requested; called active file for short) is displayed in the left-hand pane and is compared against a second file (*see screenshot below*).

```

<OrgChart
xmlns="http://www.xmlspy.com/schemas/orgchart"
xmlns:ipo="http://www.altova.com/PO"
xmlns:xsi="http://www.w3.org/2001/XMLSchema-instance"
xsi:schemaLocation="http://www.xmlspy.com/schemas/orgchart NanonullOrg.xsd">
  <CompanyLogo href="nanonull.gif"/>
  <Name>Organization Chart</Name>
  <Office>
    <Name>Nanonull, Inc.</Name>
  </Office>
</OrgChart
xmlns="http://www.xmlspy.com/schemas/orgchart"
xmlns:ipo="http://www.altova.com/PO"
xmlns:xsi="http://www.w3.org/2001/XMLSchema-instance"
xsi:schemaLocation="http://www.xmlspy.com/schemas/orgchart OrgChart.xsd">
  <CompanyLogo href="nanonull.gif"/>
  <Name>Organization Chart</Name>
  <Office>
    <Name>Nanonull, Inc.</Name>
  </Office>

```

- *Three-way comparison (Enterprise Edition only):* Three files are compared. The active file is displayed in the left-hand pane. The first of the two files that were selected for comparison against the active file is displayed in the middle pane. This middle file is known as the base file. You can merge a difference between the left-hand file and the base file, or a difference between the right-hand file and the base file.

Note: You should not move panes in the window; otherwise, the Copy To directions of the buttons in the Compare Files control window might not be correct any longer.

Differences and conflicts

Differences and conflicts are highlighted in different colors (see [Highlight colors](#)¹⁰¹² below) and can be navigated separately.

- *Differences:* When content at corresponding locations in two files is different. Highlighted in green.
- *Conflicts:* When content at corresponding locations in three files is different. Highlighted in pink.

Note: Two-way comparisons show only differences, no conflicts.

Navigating differences and conflicts

You can navigate through the document by using the buttons in the Select Difference pane of the Compare Files control window (shown below: two-way comparison, followed by three-way comparison). The pane contains four buttons for two-way comparison, and six buttons for three-way comparison (see screenshots).

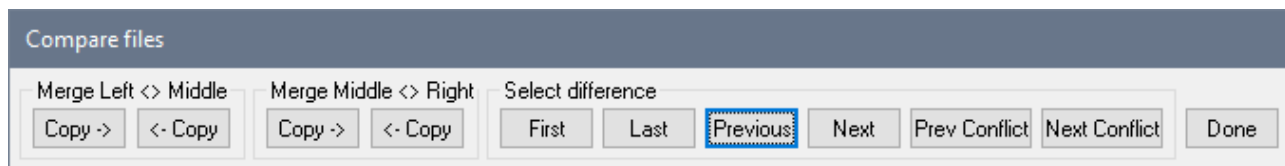

The Compare Files control window contains the following buttons:

- *First:* Goes to the first of all the differences and conflicts in the document.
- *Last:* Goes to the last of all the differences and conflicts in the document.
- *Previous:* Goes to the previous difference from the currently active difference or conflict.
- *Next:* Goes to the next difference from the currently active difference or conflict.
- *Previous Conflict:* Goes to the previous conflict from the currently active difference or conflict.
- *Next Conflict:* Goes to the next conflict from the currently active difference or conflict.

Merging differences and conflicts

You can use the buttons in the *Merge* pane to copy the highlighted content from one pane to another. Use the appropriate *Copy-direction* button of a pane-pair. In order to enable merging, the following [Compare options](#)¹⁰¹⁵ must be set:

- *Detailed differencing* must be checked, and
- *Ignore node depth* must be unchecked.

When you finish reviewing and/or merging differences, click **Done**.







Note: If you wish to undo a merge, stop the Compare session, select the file in which the change is to be undone, and select **Edit | Undo** or press **Ctrl+Z**.

Note: While the Compare session is active, no editing or change of views is allowed. Any attempt to edit or change the view of either file will pop up a message warning that the Compare session will be ended.

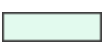
Highlight colors

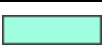
If corresponding lines are different in two files, then they are highlighted in green in both files (differences). If lines are different in three files, then they are highlighted in pink in all three files. If a difference is selected, it is indicated in both files in a darker green color. If a conflict is selected, it is indicated in both files in a darker pink color.

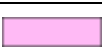
The highlight colors used in Compare sessions are given in the table below.

| | |
|---|----------------------------------|
|  | <i>Difference</i> |
|  | <i>Current difference</i> |
|  | <i>Merged difference</i> |
|  | <i>Current merged difference</i> |
|  | <i>Conflict</i> |
|  | <i>Current conflict</i> |

25.14.5.2 Compare Directories

The **Compare Directories** command allows you to compare two directories, with or without their sub-directories. Directories are compared to indicate missing files, and whether files of the same name are different or not.

To compare two directories:

1. Click **Tools | Compare directories**. The following dialog appears.

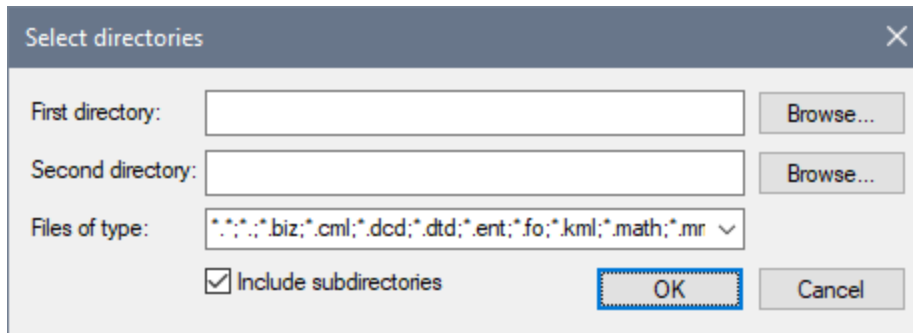





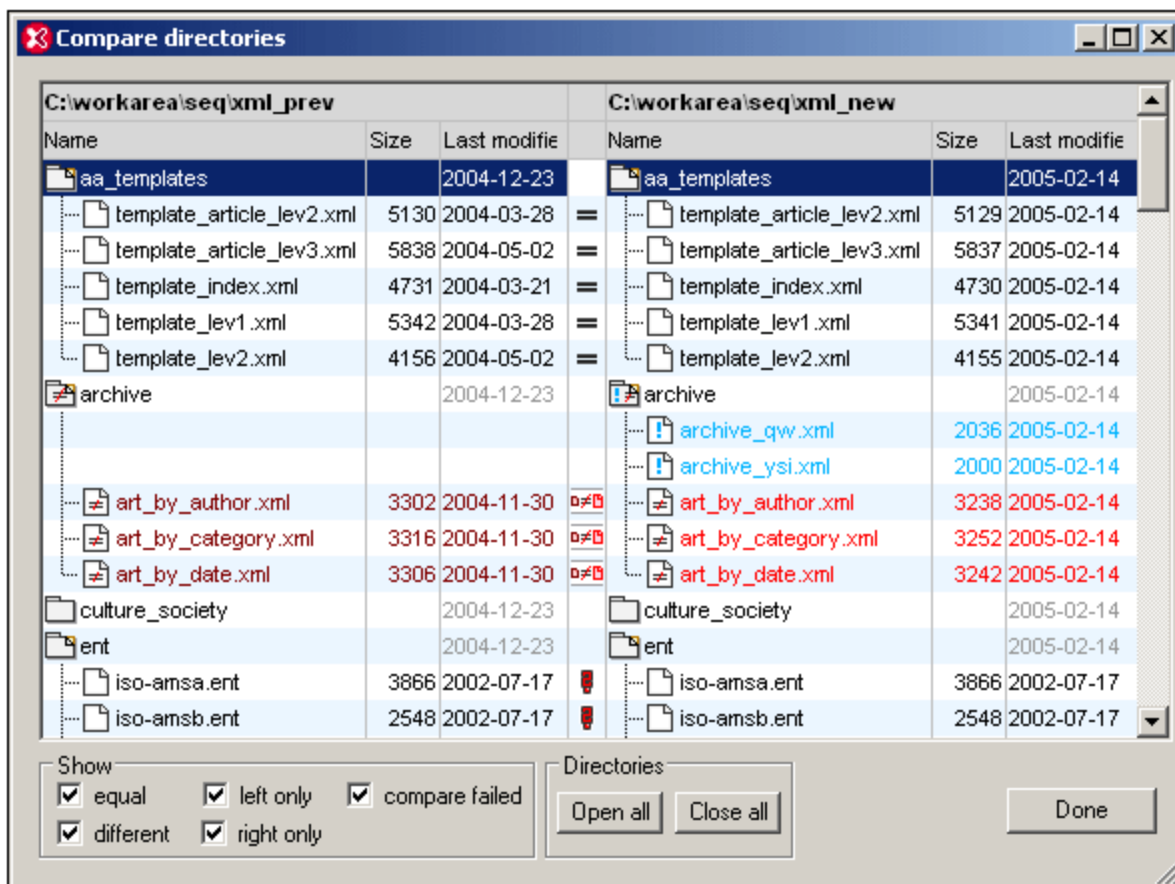

2. Browse for the directories to compare, and check the *Include subdirectories* check box if you wish to include subdirectories in the Compare.
3. Select the file types you want to compare in the Files of type field. There are three options in the dropdown menu: (i) XML filetypes; (ii) [Filetypes defined in XMLSpy](#)¹⁰⁴³; and (iii) all filetypes.
4. Click **OK**. The Settings dialog (described in [Compare Options](#)¹⁰¹⁵) appears.
5. Select the required settings for comparing files.
6. Click **OK**. A dialog will appear indicating the progress of the Compare.

The result will appear in a window, and will look like this:







Directory symbols

All directory names are given in black.

-  Directory is collapsed and its contents are not displayed.
-  Directory is expanded, indicated by the turned down corner. The contents are displayed.
-  Directory contains files, all of which either cannot be compared or are not different from the corresponding file in the compared directory.
-  Directory contains one or more files that do not exist in the compared directory.
-  Directory contains one or more files that are different from the corresponding file in the compared directory.
-  Directory contains one or more files that do not exist in the compared directory and one or more files that are different from the corresponding file in the compared directory.

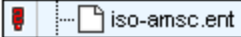
File symbols

The colors in which file names appear depend on their compare status. These colors are noted below.

-  iso-amsc.ent This file cannot be compared (with the corresponding file in the compared directory). A question mark appears in the middle column. The file name appears in black.
-  temp.xml This file is not different from the corresponding file in the compared directory. An equals-to sign appears in the middle column. The file name appears in black.
-  archive.xml This file does not exist in the compared directory. The middle column is empty. The file name appears in blue.
-  art.xml This file is different from the corresponding file in the compared directory, and the last modification to this file is more recent than the last modification to the corresponding file. The newer file appears in a brighter red, and the icon shows the brighter red file symbol on the side having the newer file.

Viewing options

- Select what files to show by checking or unchecking the options in the Show pane at the bottom of the Result window.
- Open or close all subdirectories by clicking the appropriate button in the Directories pane.
- Expand or collapse subdirectories by double-clicking the folder icon.
- The Size and Last Modified can be toggled on and off by right-clicking on either file titlebar and clicking Size and Last Modified.



- Change column widths by dragging columns.
- The Result window can be maximized, minimized, and resized.

Comparing and merging files

Double-clicking on a line opens both files on that line in the Main Window, and directly starts a File Compare for the two files. You can then continue as in a regular Compare session (see [Compare open file with...](#)¹⁰⁰⁸).

25.14.5.3 Compare Options

Click **Tools | Compare options** to open the Settings dialog (see *screenshot*). In it you make the settings for your Compare sessions. The settings that are current when a Compare session is started are the settings that are applied to that Compare session.

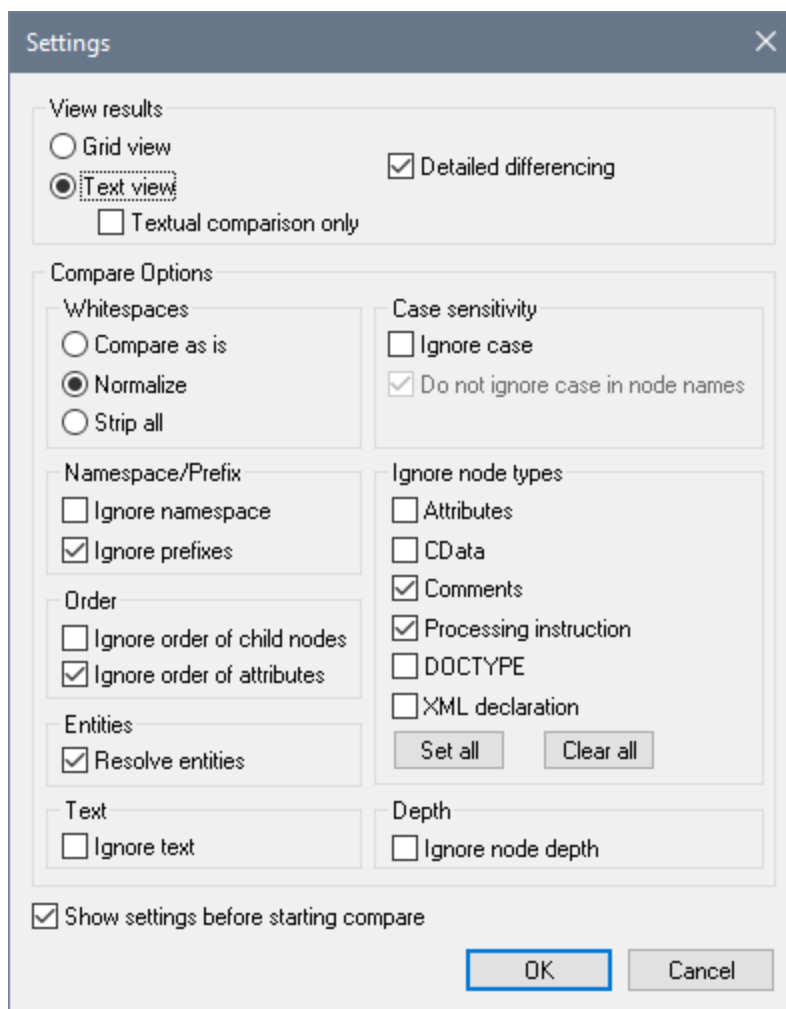

View results

Selects the view in which results are shown. You can select from the following options:

- Grid View (XML comparison)
- Text View with Textual Comparison Only unchecked (XML comparison)
- Text View with Textual Comparison Only checked (Text comparison)

If a view that provides XML comparison is selected, then the documents are treated as XML documents, and XML Compare Options are enabled. If Text comparison is selected, only Compare Options valid for Text comparison (Whitespaces and Case-sensitivity) are enabled; all other Compare Options are disabled.

Note: You can merge differences in both Grid View and Text View, and in both XML and Text comparison modes. If you wish to undo a merge, stop the Compare session, select the file in which the change is to be undone, and select **Edit | Undo** or press **Ctrl + Z**.

Detailed differencing

If unselected, differences in immediate sibling elements are represented as a single difference, and the merge option is disabled. If selected, differences in immediate siblings are represented as separate differences, and merging is enabled.

Note: The **Detailed differencing** check box must be checked to enable merging.

Whitespaces

Whitespace characters are space, tab, carriage return, and line feed. When whitespace is normalized, consecutive whitespace characters are reduced to one whitespace character; however, note that, according to the XML specification, leading and trailing whitespace in attribute values are completely removed when whitespace is normalized. The options here compare files with: (i) whitespace unchanged; (ii) whitespace normalized; and (iii) all whitespace stripped. The Whitespaces option is available for both XML and Text comparisons.

Case sensitivity

If the **Ignore case** check box is checked, then you have the option of ignoring or not ignoring case in node names (for XML comparisons only). The Case-sensitivity option is available for both XML and Text comparisons.

Namespace/Prefix

These are options for ignoring namespaces and prefixes when searching for differences.

Order

If **Ignore order of child nodes** is checked, then the position of child nodes relative to each other does not matter. The comparison is made for the entire set of child nodes, and if the only difference between a child node in one document and a child node in the compare document is the relative position in the nodeset, then this difference is ignored. Each child element node is identified by its name, its attributes, and its position. If the names of more than one node in the sibling set are the same, then the position of these nodes is used to identify the nodes even if the "Ignore order of child nodes" option is checked. This option applies to each level separately. If **Ignore order of child nodes** is unchecked, then differences in order are represented as differences.

The option of ignoring the **order of attributes** is also available, and applies to the order of attributes of a single element.

Entities

If "Resolve entities" is selected, then all entities in the document are resolved. Otherwise the files are compared with the entities as is.

Text

If "Ignore text" is selected, then differences in corresponding text nodes are not reported.

Ignore node types

Check the node types that will not be compared in the Compare session. Node types that may be ignored are Attributes, CDATA, Comments, Processing Instructions, DOCTYPE statements, and the XML declaration.

Depth

If **Ignore node depth** is checked, then the additional depth of any element (i.e. more levels of descendants) relative to the depth of the corresponding element in the compared file is ignored. This option must be unchecked to enable merging.

Show settings before starting compare

Checking this option causes the Settings dialog (this dialog) to appear before each file or directory comparison is carried out (via the **Compare open file with** and **Compare Directories** commands). Having the Settings dialog appear before each comparison allows you to check and modify the settings for each comparison.

If this command is unchecked, then the Compare session will start directly when a comparison is invoked.

25.14.6 User-Defined Tools

Placing the cursor over the **User-defined Tools** command rolls out a sub-menu containing custom-made commands that use external applications. You can create these commands in the [Tools tab of the Customize dialog](#)¹⁰²⁶. Clicking one of these custom commands executes the action associated with this command.

The **User-Defined Tools | Customize** command opens the [Tools tab of the Customize dialog](#)¹⁰²⁶ (in which you can create the custom commands that appear in the menu of the **User-Defined Tools** command.)

25.14.7 Global Resources

The **Global Resources** command pops up the Global Resources dialog (*screenshot below*), in which you can:

- Specify the Global Resources XML File to use for global resources.
- Add file, folder, and database global resources (or aliases)
- Specify various configurations for each global resource (alias). Each configuration maps to a specific resource.

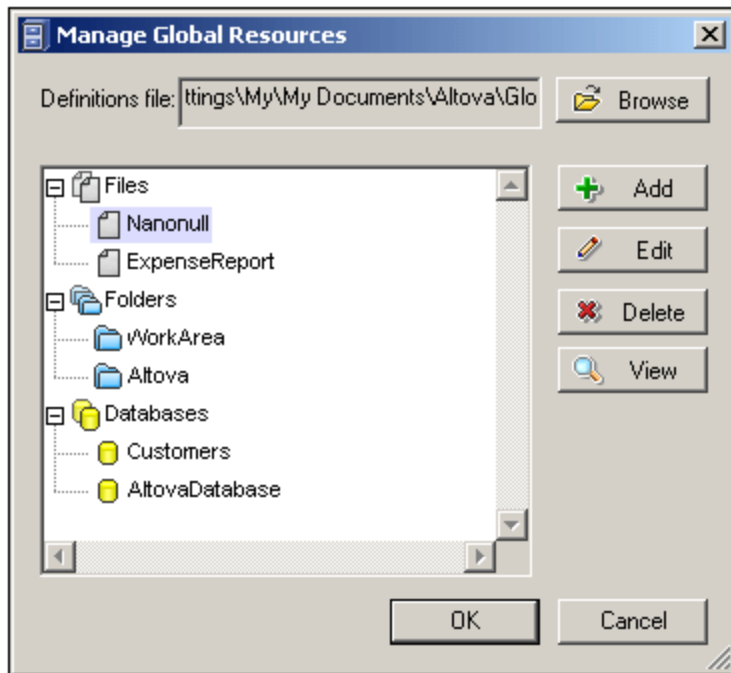

How to define global resources is described in detail in the section, [Defining Global Resources](#)⁶⁹⁶.

Note: The Altova Global Resources dialog can also be accessed via the [Global Resources toolbar](#)¹⁰²⁴ (**Tools | Customize | Toolbars | Global Resources**).

25.14.8 Active Configuration

Mousing over the **Active Configuration** menu item rolls out a submenu containing all the configurations defined in the currently active [Global Resources XML File](#)¹⁰¹⁷ (screenshot below).

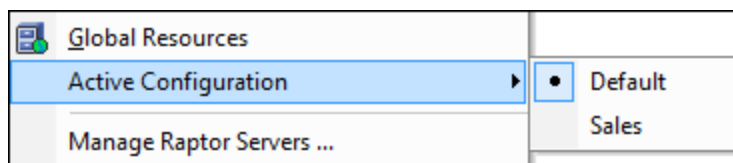

The currently active configuration is indicated with a bullet. In the screenshot above the currently active configuration is `Default`. To change the active configuration, select the configuration you wish to make active.

Note: The active configuration can also be selected via the [Global Resources toolbar](#)¹⁰²⁴ (**Tools | Customize | Toolbars | Global Resources**).

25.14.9 Manage Raptor Servers

The **Manage Raptor Servers** command enables you to add multiple Raptor Servers to the pool of available Raptor Servers and to then define multiple configurations for each server. For an overview of how to use RaptorXML Server for validating XML and XBRL documents, see the topic [Validating with RaptorXML Server](#)⁷²¹.

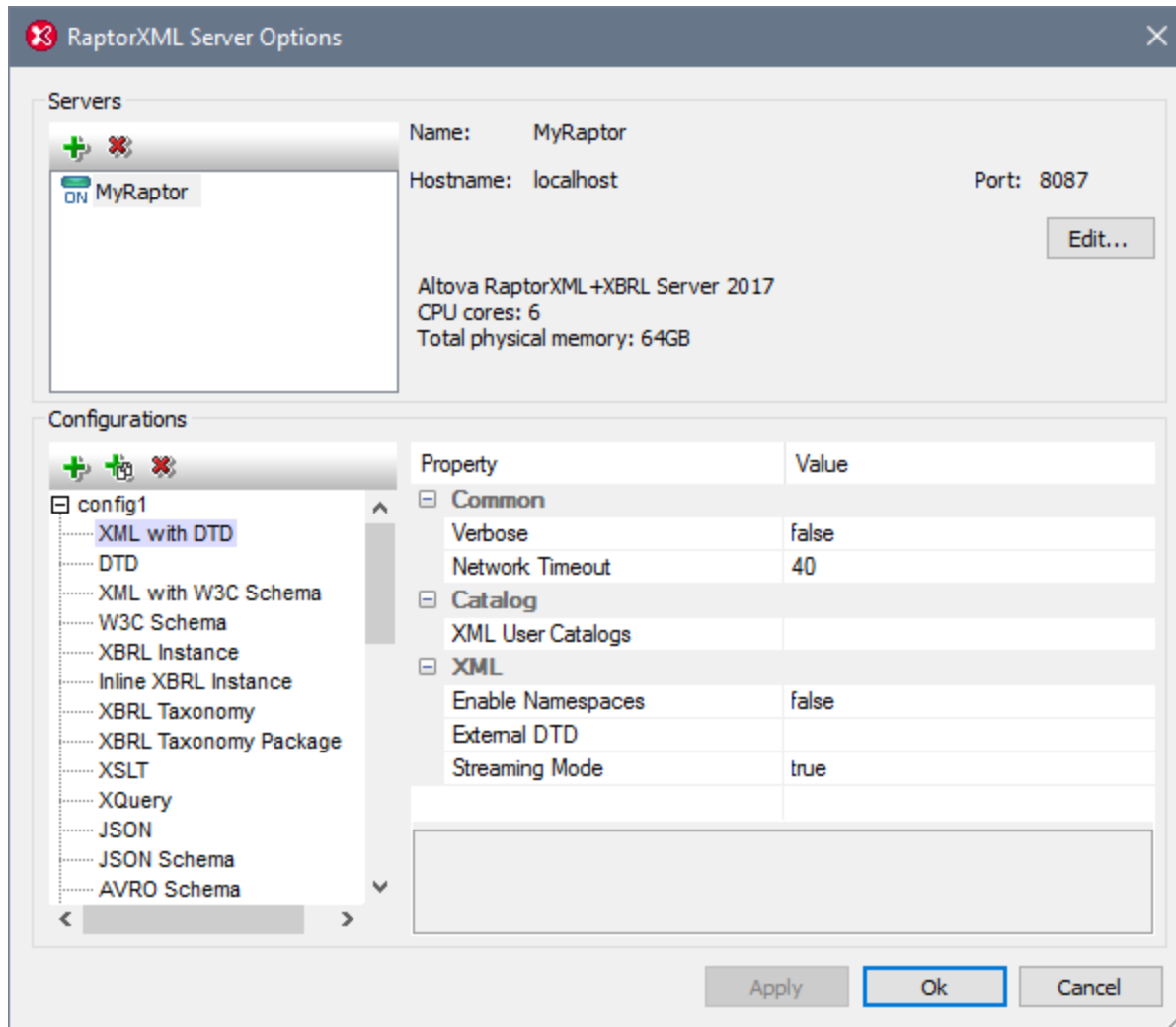

Adding a Raptor Server

In the dialog's *Servers* pane (screenshot below), click the **Add Server** icon, then enter the name by which you wish to identify the Raptor server, the network name of the machine on which Raptor is installed (host name), and the port of the Raptor Server. Click **OK** to save the settings.

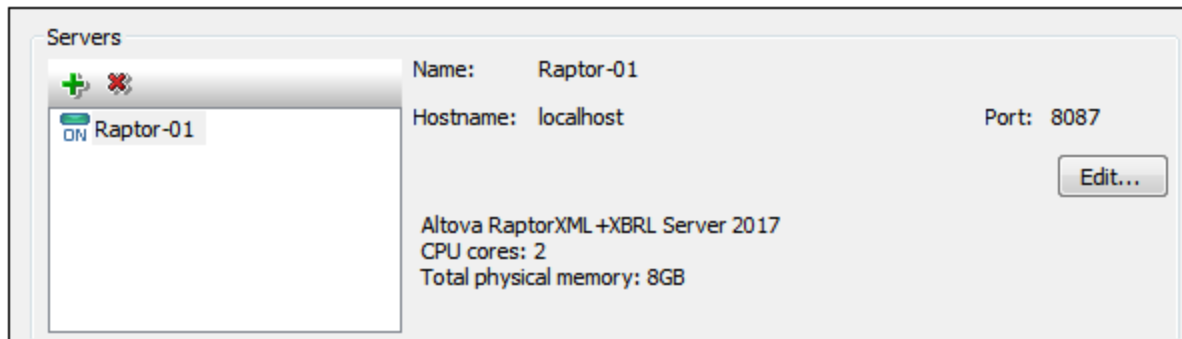

- **Name:** Any string you choose. It is used in XMLSpy to identify a particular RaptorXML Server.
- **Host name:** The name or IP address of the network machine on which the Raptor server is installed. Processing will be faster if you use an IP address rather than a host name. The IP address corresponding to `localhost` (the local machine) is `127.0.0.1`.
- **Port:** The port via which the Raptor server is accessed. This port is specified in Raptor's configuration file (called `server_config.xml`). The port must be fixed and known so that requests can be correctly addressed to the service. For more information about the Raptor configuration file, see the user manuals: [RaptorXML Server](#) and [RaptorXML+XBRL Server](#).

After entering the server information, click **OK**. The server name you entered appears in the server list (in the left of the pane). A green icon appears next to the server's name, indicating that the Raptor server has been started and is running. The details of the server are displayed in the pane (see *screenshot above*). A red icon indicates that the server is offline. If the server cannot be found, an error message is displayed.

Note: The Raptor server must be running when the server is added. This is necessary so that XMLSpy can obtain information about the server and store it. If, after the server has been added, the server is offline or cannot be found, then these situations are indicated, respectively, by a red icon or an error message.

To edit a server's name, host name, or port, select the server in the left-hand pane, click the **Edit** button, and, in the dialog that appears, edit the information you want to change. To remove a server from the pool, select the server and click the **Remove Selected Server** icon.

Server Configurations

A configuration is a set of RaptorXML validation options. When a server is added, it will have a configuration named `default`. This is a set of RaptorXML options set to their default values. You can add new configurations that contain other option values. After you have defined multiple server configurations, you can select one configuration to be the active configuration. This is the configuration that will be used when the **Validate on Server** command is executed.

The *Configurations* pane has two parts: (i) a left-hand pane, which shows the configurations, each containing a list of document-types that can be validated; (ii) a right-hand pane, which displays the validation options for the document-type selected in the left-hand pane; at the bottom of the right-hand pane is a description of the selected option (see *screenshot above*).

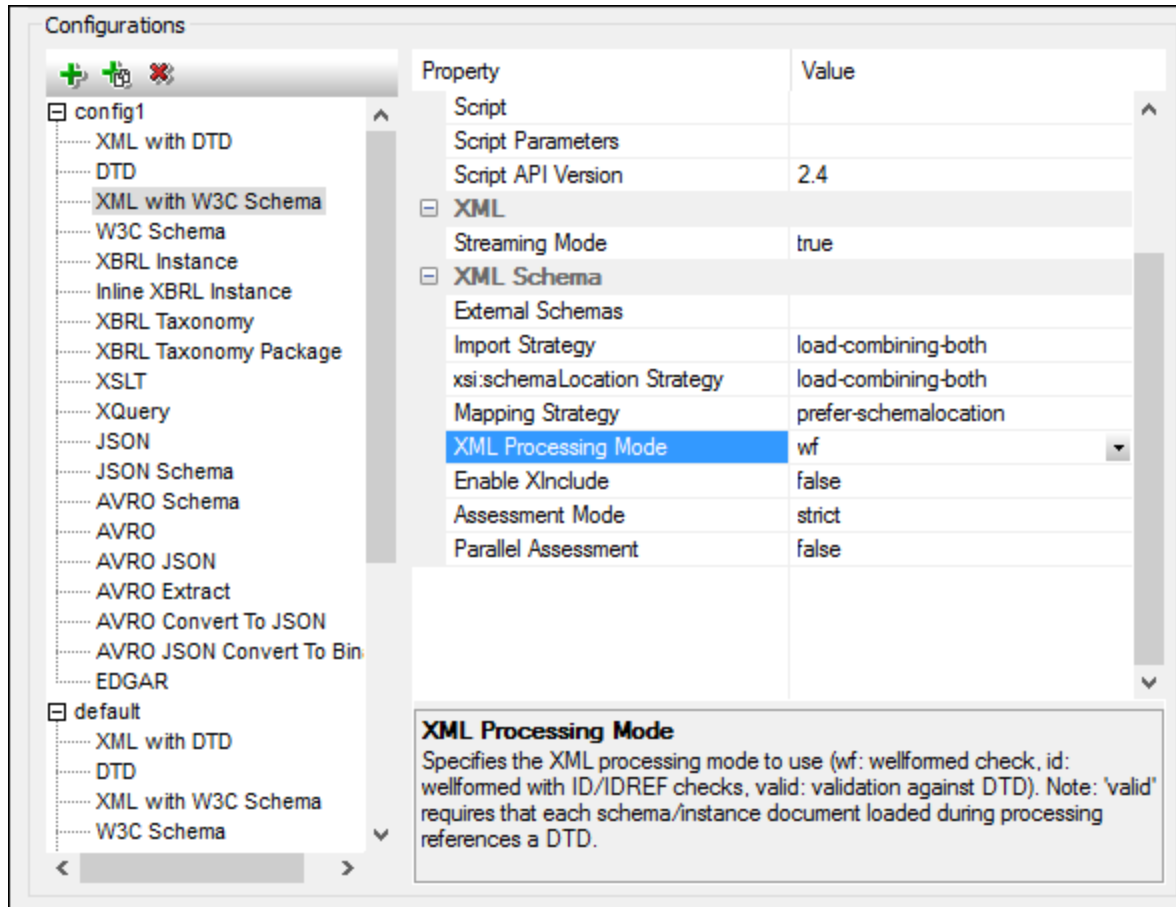

Adding a configuration

In the *Configurations* pane of the RaptorXML Server Options dialog (*screenshot above*), click **Add a Configuration**. A new configuration is added with default option values. You can also create a new configuration by clicking **Copy Selected Configuration**. This creates a new configuration with option values that are the same as that of the copied configuration. New configurations are created with default names of the type `config<X>`; you can edit the name of a configuration by double-clicking it and entering the new name. You can then edit any of the configuration's option values.

Editing a configuration's option values

First, select the document-type in the left-hand pane. This displays the validation options of the selected document-type in the right-hand pane. To edit the value of an option, do one of the following (depending on the type of option value):

- If the value can be one of a set of predefined values, select the value you want from the combo box of that option's value column.
- If the value is not constrained, click in the option's value field and enter the value you want.
- If the value is a file path, in addition to being able to enter the value, you can also browse for the file you want by using the **Browse** button in the option's value column.

If you select an option, its description is displayed in a box at the bottom of the right-hand pane. For more

detailed descriptions of each option, see the command line interface chapters of the [RaptorXML Server](#) and [RaptorXML\(+XBRL\) Server](#) user manuals.

Removing a configuration

In the left-hand pane, select the configuration to be removed and click **Remove Selected Configuration**.

25.14.10 Raptor Servers and Configurations

If you have defined multiple configurations on multiple servers, you can select a server and one of its configurations as the active configuration. The active configuration will be used for subsequent validations. On placing the cursor over the **Tools | Raptor Servers and Configurations** command (see *screenshot below*), a submenu appears that contains all the added servers, together with the configuration of each. Select the server configuration you want to make the active configuration. In the screenshot below, the `xbrl` configuration of the server named `Raptor-01` has been selected as the active configuration (indicated by the green arrow).

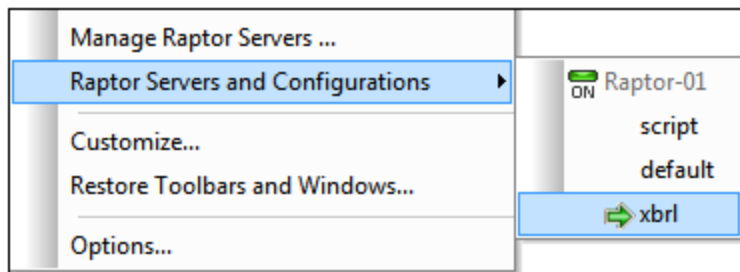

See the section [RaptorXML\(+XBRL\) Server](#)⁷²¹ for an overview of how to use Raptor from within XMLSpy.

25.14.11 XML Schema Manager

This command opens the Schema Manager dialog, which enables you to manage your XML Schema packages.

To install an XML schema, select the check box next to the schema you want to install and click **Apply**. You can also uninstall schemas, upgrade schemas, check for new schemas, and generally manage all your schemas in one central location.

For more information, see [Schema Manager](#)³⁰⁷.

25.14.12 Customize

The **Customize** command lets you customize application menus and toolbars to suit your personal needs. Clicking the command pops up the Customize dialog, which has the following tabs:

- [Commands](#)¹⁰²³: All application and macro commands can be dragged from this tab into menu bars, menus and toolbars.
- [Toolbars](#)¹⁰²⁴: Toolbars can be activated, deactivated, and reset individually.
- [Tools](#)⁹⁹⁹: Commands that open external programs from within the interface can be added to the interface.
- [Keyboard](#)¹⁰²⁷: Keyboard shortcuts can be created for individual application and macro commands.
- [Menu](#)¹⁰³¹: Menu bars and context menus to be customized are selected and made active in this tab. Works together with the Commands tab.
- [Macros](#)¹⁰³³: Macros can have new commands associated with them.
- [Plug-ins](#)¹⁰³⁴: Plug-ins can be activated and integrated in the interface.
- [Options](#)¹⁰⁴⁰: Display options for toolbars are set in this tab.

This section also describes the [context menu](#)¹⁰³⁶ that appears when the Customize dialog is open and menu bar, menu, or tool bar items are right-clicked.

25.14.12.1 Commands

The **Commands** tab allows you customize your menus and toolbars. You can add application commands to menus and toolbars according to your preference. Note, however, that you cannot create new application commands or menus yourself.

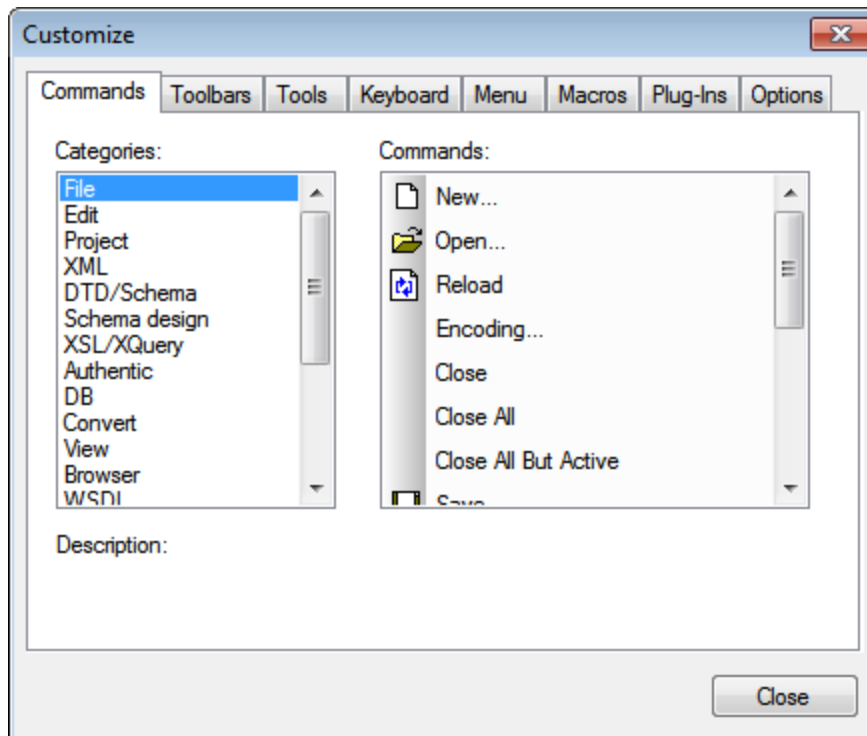

To add a command to a toolbar or menu:

1. Select the menu item **Tools | Customize**. The Customize dialog appears.
2. Select the **All Commands** category in the *Categories* list box. The available commands appear in the *Commands* list box.

3. Click on a command in the *Commands* list box and drag it to an existing menu or toolbar. An I-beam appears when you place the cursor over a valid position to drop the command.
4. Release the mouse button at the position you want to insert the command.

Note the following points:

- When you drag a command, a small button appears at the tip of mouse pointer: This indicates that the command is currently being dragged.
- An "x" below the pointer indicates that the command cannot be dropped at the current cursor position.
- If the cursor is moved to a position at which the command can be dropped (a toolbar or menu), the "x" disappears and an I-beam indicates the valid position.
- Commands can be placed in menus or toolbars. If you have [created your own toolbar](#)¹⁰²⁴, you can use this customization mechanism to populate it.
- Moving the cursor over a closed menu, opens that menu, allowing you to insert the command anywhere in that menu.

Adding commands to context menus

You can also add commands to context menus by dragging commands from the *Commands* list box into the context menu. The procedure is as follows:

1. In the Customize dialog, click the [Menu](#)¹⁰³¹ [tab](#)¹⁰³¹.
2. In the Context Menu pane, select a context menu from the combo box. The selected context menu pops up.
3. In the Customize dialog,, switch back to the Commands tab.
4. Drag the command you wish to create from the *Commands* list box and drop it into the desired location in the context menu.

Deleting a command or menu

To delete a command from a menu, context menu (see above for details of accessing context menus), or toolbar, or to delete an entire menu, do the following.

1. Open the Customize dialog (**Tools | Customize**). The Customize dialog appears.
2. With the Customize dialog open (and any tab selected), right-click a menu or a menu command, and then select **Delete** from the context menu that pops up. Alternatively, drag the menu or menu command till an "x" icon appears below the mouse pointer, and then drop the menu or menu command. The menu or menu command will be deleted.

To re-instate deleted menu commands, use the mechanisms described in this section. To re-instate a deleted menu, go to **Tools | Customize | Menu**, and click the **Reset** button in the *Application Frame Menus* pane. Alternatively, go to **Tools | Customize | Toolbars**, select Menu Bar, and click the **Reset** button.

25.14.12.2 Toolbars

The **Toolbars** tab allows you: (i) to activate or deactivate specific toolbars (that is, to decide which ones to display in the interface); (ii) to set what icons are displayed in each toolbar; and (iii) to create your own specialized toolbars.

The toolbars contain icons for the most frequently used menu commands. Information about each icon is displayed in a tooltip and in the Status Bar when the cursor is placed over the icon. You can drag a toolbar to any location on the screen, where it will appear as a floating window.

Note: To add a command to a toolbar, drag the command you want from the *Commands* list box in the [Commands](#)¹⁰²³ tab to the toolbar. To delete a command from a toolbar, open the *Customize* dialog, and with *Attr* tab selected, drag the command out of the toolbar (see [Commands](#)¹⁰²³ for more details).

Note: Toolbar settings defined in a particular view are, by default, valid for that view only. To make the settings apply to all views, click the check box at the bottom of the dialog.

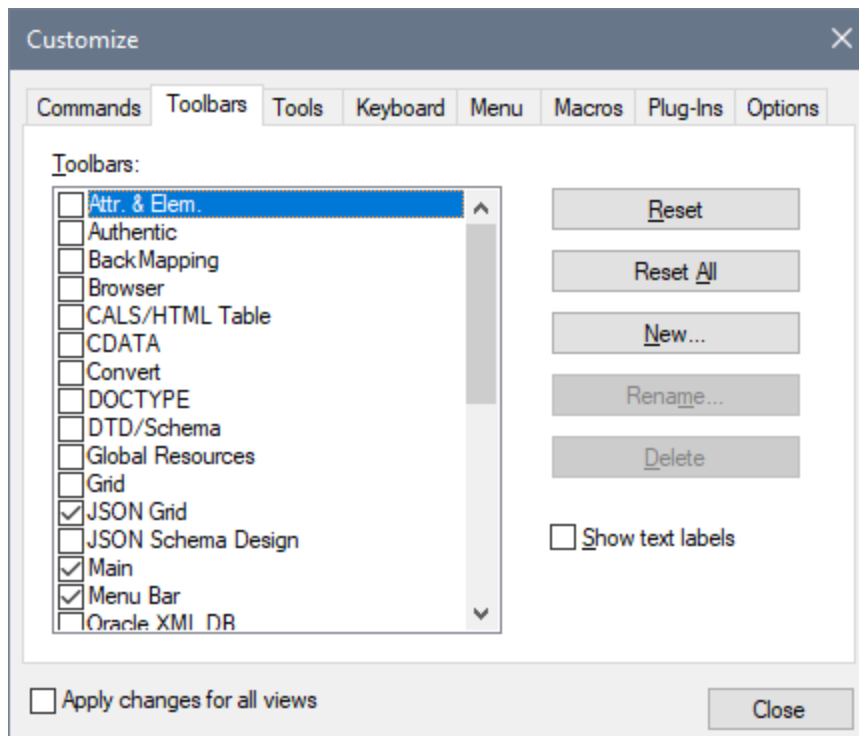

The following functionality is available:

- *To activate or deactivate a toolbar:* Click its check box in the *Toolbars* list box.
- *To apply changes to all views:* Click the check box at the bottom of the dialog. Otherwise, changes are applied only to the active view. Note that only changes made **after** clicking the *All Views* check box will apply to all views.
- *To add a new toolbar:* Click the **New** button and give the toolbar a name in the *Toolbar Name* dialog that pops up. From the [Commands](#)¹⁰²³ tab drag commands into the new toolbar.
- *To change the name of an added toolbar:* Select the added toolbar in the *Toolbars* pane, click the **Rename** button, and edit the name in the *Toolbar Name* dialog that pops up.
- *To reset the Menu bar:* Select the *Menu Bar* item in the *Toolbars* pane, and then click **Reset**. This resets the *Menu bar* to the state it was in when the application was installed.

- *To reset all toolbar and menu commands:* Click the **Reset All** button. This resets all toolbars and menus to the states they were in when the application was installed.
- *To delete a toolbar:* Select the toolbar you wish to delete in the Toolbars pane and click **Delete**.
- *To show text labels of commands in a particular toolbar:* Select that toolbar and click the *Show Text Labels* check box. Note that text labels have to be activated for each toolbar separately.

25.14.12.3 Tools

The **Tools** tab allows you to set up commands to use external applications from within XMLSpy. These commands will be added to the **Tools | User-defined Tools** menu. For example, the active file in the main window of XMLSpy can be opened in an external application, such as Notepad, by clicking a command in the **Tools | User-defined Tools** menu that you created.

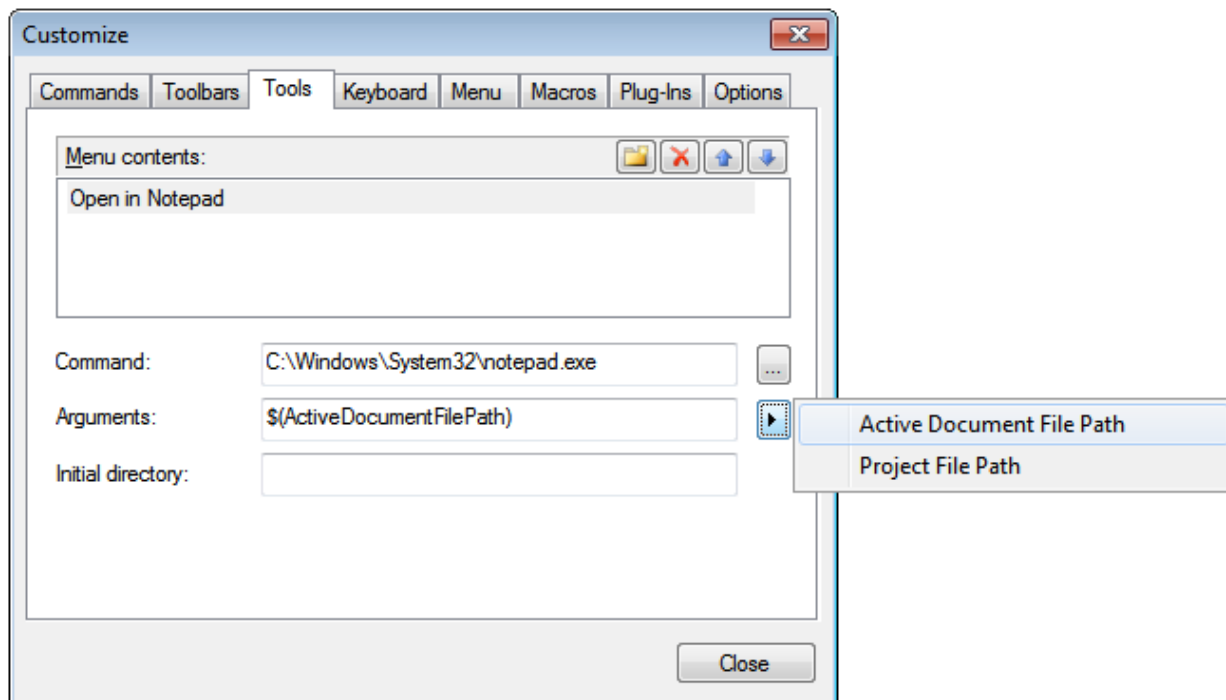

To set up a command to use an external application, do the following:

1. In the *Menu Contents* pane (see screenshot above), click the **New** icon in the title bar of the pane and, in the item line that is created, enter the name of the menu command you want. In the screenshot above, we have entered a single menu command, **Open in Notepad**. We plan to use this command to open the active document in the external Notepad application. More commands can be added to the command list by clicking the **New** icon. A command can be moved up or down the list relative to other commands by using the **Move Item Up** and **Move Item Down** icons. To delete a command, select it and click the **Delete** icon.

2. To associate an external application with a command, select the command in the *Menu Contents* pane. Then, in the *Command* field, enter the path to, or browse for, the executable file of the external application. In the screenshot above, the path to the Notepad application has been entered in the *Command* field.
3. The actions available to be performed with the external application are displayed when you click the flyout button of the *Arguments* field (see screenshot above). These actions are described in the list below. When you select an action, a code string for the action is entered in the *Arguments* field.
4. If you wish to specify a current working directory, enter it in the *Initial Directory* field.
5. Click **Close** to finish.

The command/s you created will appear in the **Tools | User-defined Tools** menu, and in the context menu of Project window files and folders—in the **User-defined Tools** submenu.

When you click the command (in the **Tools | User-defined Tools** menu) that you created, the action you associated with the command will be executed. The command example shown in the screenshot above does the following: It opens, in Notepad, the document that is active in the Main Window of XMLSpy. The external application command is also available in the context menu of files in the Project window (right-click a file in the Project window to display that file's context menu). Via the Project Window you can also open multiple files (for applications that allow this) by making a multi-selection and then selecting the command from the context menu.

Arguments

The *Arguments* field specifies the action to be executed by the external application command. The following arguments are available.

- *Active Document File Path*: The command in the **Tools | User-defined Tools** menu opens the document that is active in XMLSpy in the external application. The command in the context menu of a file in the Project window opens the selected file in the external application.
- *Project File Path*: Opens the XMLSpy project file (the `.spp` file) in the external application.

Initial directory

The *Initial Directory* entry is optional and is a path that will be used as the current directory.

25.14.12.4 Keyboard

The **Keyboard** tab allows you to create new keyboard shortcuts, or change existing shortcuts, for any application command.

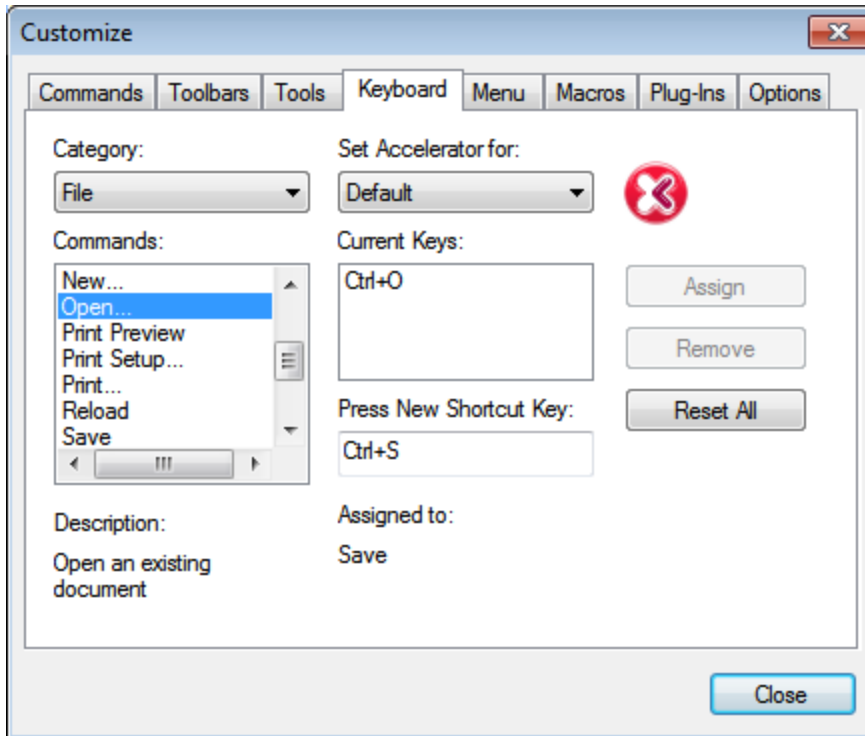

To assign a new shortcut to a command, or to change an existing shortcut, do the following.

1. Select the *All Commands* category in the *Category* combo box. Note that if a [macro has been selected as an Associated Command](#)¹⁰³³, then macros are also available for selection in the *Category* combo box and a shortcut for the macro can be set.
2. In the *Commands* list box, select the command to which you wish to assign a new shortcut or select the command the shortcut of which you wish to change.
3. Click in the *Press New Shortcut Key* text box, and press the shortcut you wish to assign to that command. The shortcut appears in the *Press New Shortcut Key* text box. If the shortcut has not yet been assigned to any command, the **Assign** button is enabled. If the shortcut has already been assigned to a command, then that command is displayed below the text box and the **Assign** button is disabled. (To clear the *Press New Shortcut Key* text box, press any of the control keys, **Ctrl**, **Alt** or **Shift**).
4. Click the **Assign** button to assign the shortcut. The shortcut now appears in the *Current Keys* list box. You can assign multiple shortcuts to a single command.
5. Click the **Close** button to confirm.

Deleting a shortcut

A shortcut cannot be assigned to multiple commands. If you wish to delete a shortcut, click it in the *Current Keys* list box and then click the **Remove** button.

Set accelerator for

Currently, accelerators can be set only as default. No other mode is available.

Default keyboard shortcuts

The default shortcuts of commonly used commands are listed below. An overview of all the application's menu commands is available in the Keyboard Map ([Help | Keyboard Map](#)¹⁰⁸³).

Function-key shortcuts (incl. for validation and transformation)

| | |
|------------|----------------------------|
| F1 | Help Menu |
| F1 + Alt | Open Last File |
| F3 | Find Next |
| F4 + CTRL | Close Active Window |
| F4 + Alt | Close XMLSpy |
| F5 | Refresh |
| F6 + CTRL | Cycle through Open Windows |
| F7 | Check Well-formedness |
| F8 | Validate |
| F10 | XSL Transformation |
| F10 + CTRL | XSL:FO Transformation |

File and Application commands

| | |
|------------|-------------------------------|
| Alt + F1 | Open Last File |
| CTRL + O | File Open |
| CTRL + N | File New |
| CTRL + P | File Print |
| CTRL + S | File Save |
| CTRL + F4 | Close Active Window |
| CTRL + F6 | Cycle through Open Windows |
| CTRL + TAB | Switch between Open Documents |
| Alt + F4 | Close XMLSpy |

Miscellaneous keys

| | |
|--------------------|-----------------------------------|
| Up/Down Arrow Keys | Move Cursor or Selection Bar |
| Esc | Abandon Edits or Close Dialog Box |
| Return | Confirm Selection |
| Del | Delete Character or Selected |
| Shift + Del | Cut |

Editing commands

| | |
|----------|------------|
| CTRL + A | Select All |
|----------|------------|

| | |
|----------|-----------------|
| CTRL + F | Find |
| CTRL + G | Go to Line/Char |
| CTRL + H | Replace |
| CTRL + V | Paste |
| CTRL + X | Cut |
| CTRL + Y | Redo |
| CTRL + Z | Undo |

☐ *Text View commands*

| | |
|-------------------------|-------------------------------------|
| CTRL + E | Jump between Start/End Tags |
| CTRL + Shift + E | Select Element that Contains Cursor |
| CTRL + Alt + E | Go to Parent Element |
| CTRL + "+" | Zoom In |
| CTRL + "-" | Zoom Out |
| CTRL + 0 | Reset Zoom |
| CTRL + mousewheel forwd | Zoom In |
| CTRL + mousewheel back | Zoom Out |

☐ *Grid View commands*

| | |
|------------------|---------------------|
| CTRL + D | Append CDATA |
| CTRL + E | Append Element |
| CTRL + I | Append Attribute |
| CTRL + M | Append Comment |
| CTRL + T | Append Text |
| | |
| CTRL + Shift + D | Insert CDATA |
| CTRL + Shift + E | Insert Element |
| CTRL + Shift + I | Insert Attribute |
| CTRL + Shift + M | Insert Comment |
| CTRL + Shift + T | Insert Text |
| | |
| CTRL + Alt + D | Add Child CDATA |
| CTRL + Alt + E | Add Child Element |
| CTRL + Alt + I | Add Child Attribute |
| CTRL + Alt + M | Add Child Comment |
| CTRL + Alt + T | Add Child Text |

☒ *Schema View commands*

| | |
|--------------------------|----------------------------|
| CTRL + Dbl-click Element | Display Element Definition |
|--------------------------|----------------------------|

☒ *Debugger shortcuts*

| | |
|-------------------|---------------------------|
| F9 | Insert/Remove Breakpoint |
| F9 + Shift | Insert/Remove Tracepoint |
| F9 + CTRL | Enable/Disable Breakpoint |
| F9 + Shift + CTRL | Enable/Disable Tracepoint |
| F11 | Step Into |
| F11 + Shift | Step Out |
| F11 + CTRL | Step Over |
| F11 + Alt | Start Debugger/Go |

25.14.12.5 Menu

The **Menu** tab allows you to customize the two main menu bars (default and application menu bars) as well as the application's context menus.

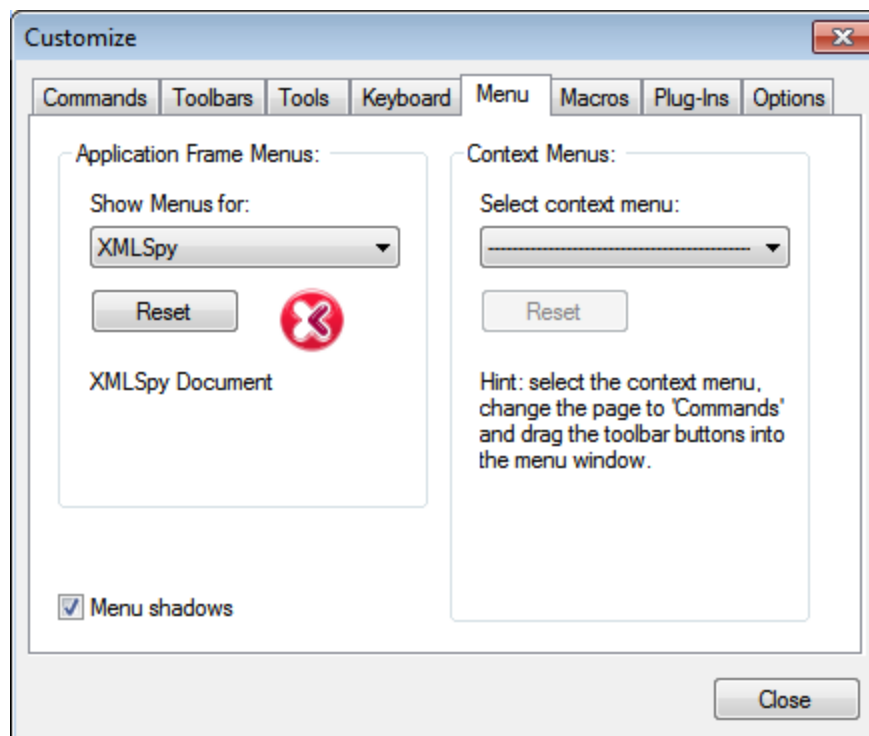

Customizing the default menu bar and application menu bar

The default menu bar is the menu bar that is displayed when no document is open in the main window. The application menu bar is the menu bar that is displayed when one or more documents are open in the main window. Each menu bar can be customized separately, and customization changes made to one do not affect the other.

To customize a menu bar, select it in the *Show Menus For* combo box (see screenshot above). Then switch to the [Commands tab of the Customize dialog](#)¹⁰²³ and drag commands from the Commands list box to the menu bar or into any of the menus.

Deleting commands from menus and resetting the menu bars

To **delete** an entire menu or a command inside a menu, do the following:

1. In the Application Frame Menus pane, select either *Default* (which shows available menus when no document is open) or *XMLSpy* (which shows available menus when one or more documents are open).
2. With the Customize dialog open, select (i) the menu you want to delete from the application's menu bar, or (ii) the command you want to delete from one of these menus.
3. Either (i) drag the menu from the menu bar or the menu command from the menu, or (ii) right-click the menu or menu command and select **Delete**.

You can **reset** each of these two menu bars (default and application menu bars) to its original installation state by selecting the menu in the *Show Menus For* combo box and then clicking the **Reset** button below the combo box.

Customizing the application's context menus

Context menus are the menus that appear when you right-click certain objects in the application's interface. Each of these context menus can be customized by doing the following:

1. Select the context menu you want in the *Select Context Menu* combo box. This pops up the context menu.
2. Switching to the [Commands tab of the Customize dialog](#)¹⁰²³.
3. Drag a command from the *Commands* list box into the context menu.
4. If you wish to delete a command from the context menu, right-click that command in the context menu, and click **Delete**. Alternatively, you can drag the command you want to delete out of the context menu.

You can reset any context menu to its original installation state by selecting it in the *Select Context Menu* combo box and then clicking the **Reset** button below the combo box.

Menu shadows

Click the *Menu shadows* check box to give all menus shadows.

25.14.12.6 Macros

The **Macros** tab allows you to create application commands for macros that were created using XMLSpy's Scripting Editor. These application commands (which run the macros associated with them) can subsequently be made available in menus and toolbars, either from the Macros tab directly or by using the mechanisms available in the [Commands tab of the Customize dialog](#)¹⁰²³. As application commands, they can also be assigned shortcuts in the [Keyboard tab of the Customize dialog](#)¹⁰²⁷.

How macros work in XMLSpy

Macros in XMLSpy work as follows:

- Altova scripting projects (.asprj files) are created in XMLSpy's [Scripting Editor](#)¹⁰⁹². It is these scripting projects that can contain the macros used in XMLSpy.
- Two scripting projects can be active at a time in XMLSpy: (i) An application scripting project, which is specified in the [Scripting section of the Options dialog](#)¹⁰⁷³, and (ii) The scripting project of the active [XMLSpy project](#)⁷¹⁴, which is specified in the [Script Settings dialog](#)⁸⁴⁸ ([Project | Script Settings](#)⁸⁴⁸).
- The macros in these two scripting projects are available in the application: in the **Tools | Macros** menu (from where the macros can be run), and in the Macros tab of the Customize dialog (*screenshot below*), in which they can be set as application commands. After a macro has been set as an application command, the command can be placed in a menu and/or toolbar.

Creating an application command for a macro

In [Scripting Editor](#)¹⁰⁹² ([Tools | Scripting Editor](#)¹⁰⁹²) create the macro you wish and save it to a scripting project. Specify this file to be either the application scripting project (via the [Scripting section of the Options dialog](#)¹⁰⁷³) or the active application project's scripting project (via the application project's [Script Settings dialog](#)⁸⁴⁸ ([Project | Script Settings](#)⁸⁴⁸)). The macros in the scripting project will now appear in the *Macros* pane of the Macros tab (*see screenshot below*).

To create an application command for a macro, select the macro in the *Macros* pane, set the text of the command in the *Display Text* text box, and click **Add Command** (*see screenshot below*). A command associated with the selected macro will be added to the *Associated Commands* list box.

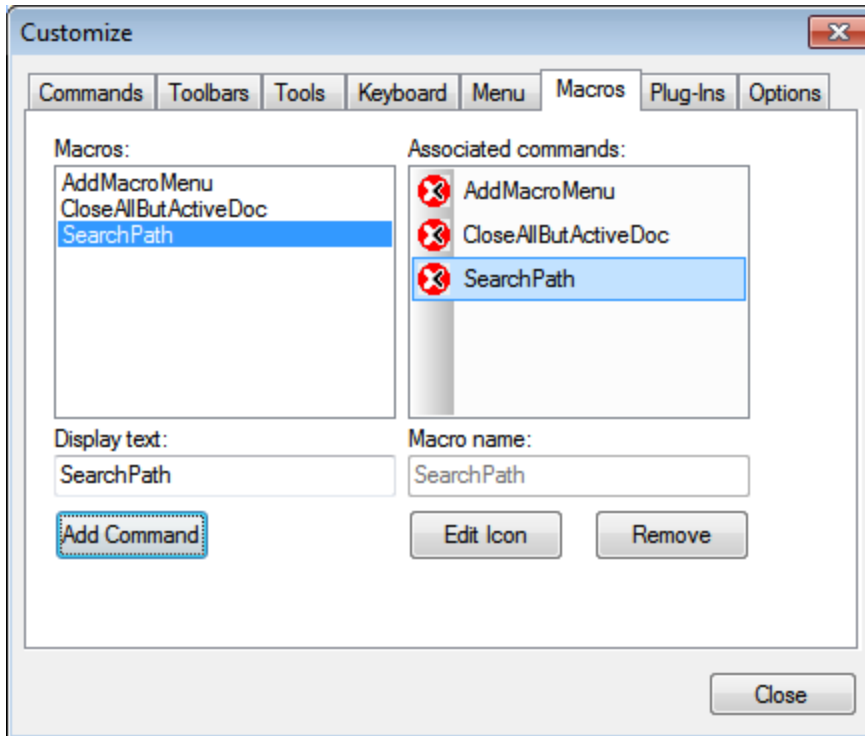

To edit the icon of an associated command, select the command and click **Edit Icon**. To delete an associated command, click **Remove**.

Placing a macro-associated command in a menu or toolbar

There are two ways to place a macro-associated command in a menu or toolbar:

- Drag the command from the Associated Commands list box to the desired location in the menu or toolbar.
- Use the mechanisms available in the [Commands tab of the Customize dialog](#)¹⁰²³.

In either case, the command will be created at the desired location. Clicking on the command in the menu or toolbar will execute the macro.

Note: If a macro has been set as an associated command, you can set a [keyboard shortcut for it](#)¹⁰²⁷. In the [Keyboard tab of the Customize dialog](#)¹⁰²⁷, select *Macros* in the *Category* combo box, then select the required macro, and set the shortcut. You must set a macro as an associated command in order for it to be available to be created as a keyboard shortcut.

25.14.12.7 Plug-Ins

The **Plug-Ins** tab allows you to integrate plug-ins and to place commands, where these have been so programmed, in an application menu and/or toolbar. In the Plug-In tab (*screenshot below*), click **Add Plug-In**, and browse for the plug-in's DLL file (*see 'Creating plug-ins' below*). Click **OK** to add the plug-in. Multiple plug-ins can be added.

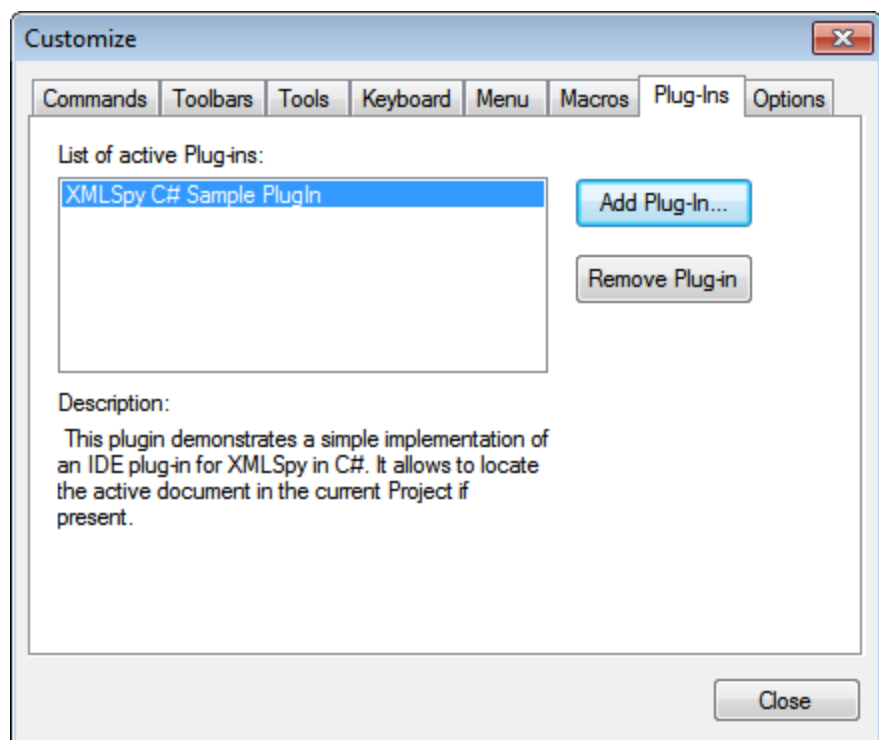

After a plug-in has been added successfully, a description of the plug-in appears in the dialog and the **Remove Plug-In** button becomes enabled. If the plug-in code creates toolbars and menus, these will be immediately visible in the application interface. To remove a plug-in select it and click **Remove Plug-In**.

Creating plug-ins

Source code for sample plug-ins has been provided in the application's [\(My\) Documents folder](#)²⁸:
`Examples\IDEPlugin` folder. To build a plug-in from such source code, do the following:

1. Open the solution you want to build as a plug-in in Visual Studio.
2. Build the plug-in with the command in the Build menu.
3. The plug-in's DLL file will be created in the `Bin` or `Debug` folder. This DLL file is the file that must be added as a plug-in (see *above*).

For more information about plug-ins, see the section [IDE Plugins](#)¹¹¹⁹.

25.14.12.8 Options

The **Options** tab allows you to define general environment settings.

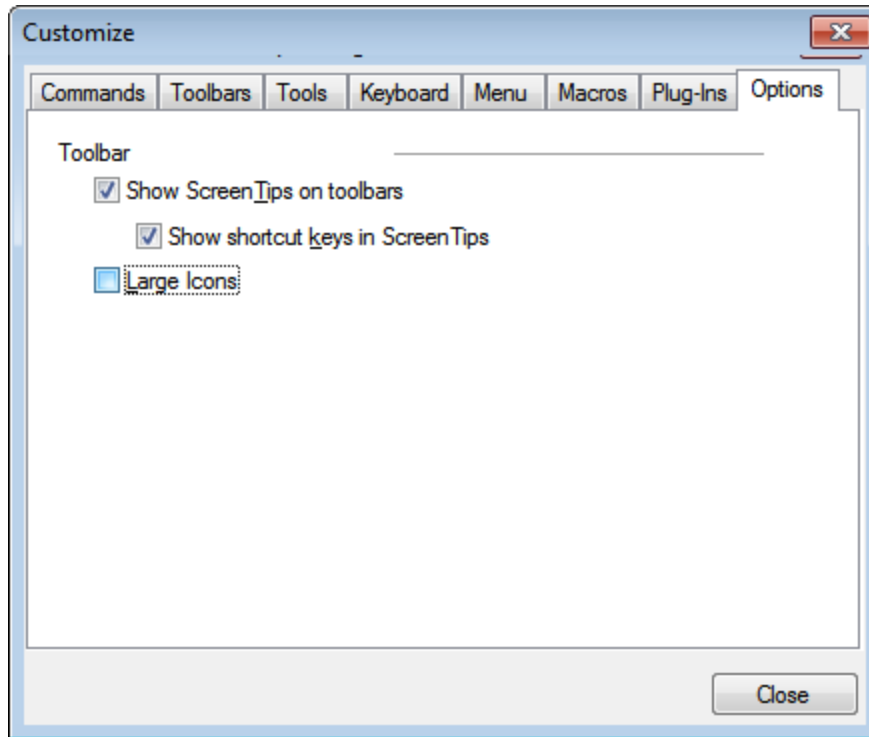

Click the check boxes to toggle on the following options:

- *Show ScreenTips on toolbar*: Displays a popup when the mouse pointer is placed over an icon in any toolbar. The popup contains a short description of the icon function, as well as the associated keyboard shortcut, if one has been assigned and if the *Show shortcut keys* option has been checked.
- *Show shortcut keys in Screen Tips*: Defines whether shortcut information will be shown in screen tips.
- *Large icons*: Toggles the size of toolbar icons between standard and large.

25.14.12.9 Customize Context Menu

The **Customize context menu** (*screenshot below*) is the menu that appears when you have the Customize dialog open and then right-click an application menu, a menu command, or a toolbar icon.

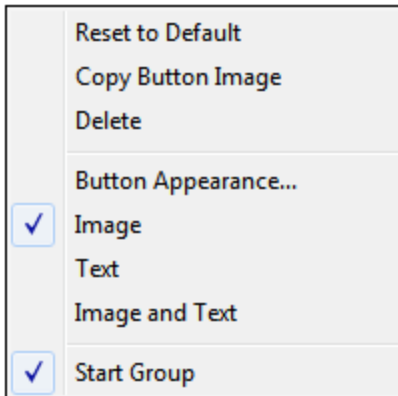

The following functionality is available:

- *Reset to Default*: Currently no function.
- *Copy Button Image*: Copies the icon you right-click to the clipboard.
- *Delete*: Deletes the selected menu, menu command, or toolbar icon. For information about how to restore deleted items, see below.
- *Button Appearance*: Pops up the Button Appearance dialog (*see screenshot below*), in which you can set properties that define the appearance of the selected toolbar icon. See the description below for details.
- *Image, Text, Image and Text*: Mutually exclusive options that determine whether the selected toolbar icon will be an icon only, text only, or both icon and text. You can select one of these options to make the change. Alternatively, you can make this change in the Button Appearance dialog.
- *Start Group*: Inserts a vertical group-divider to the left of the selected toolbar icon. This makes the selected toolbar icon the first of a group of icons.

The Button Appearance dialog

Right-click a toolbar icon and click **Button Appearance** to get the Button Appearance dialog (*screenshot below*). Via this dialog you can edit the toolbar icon image, as well as its text. Currently only toolbar icons for macros and from plug-ins can be edited using this dialog.

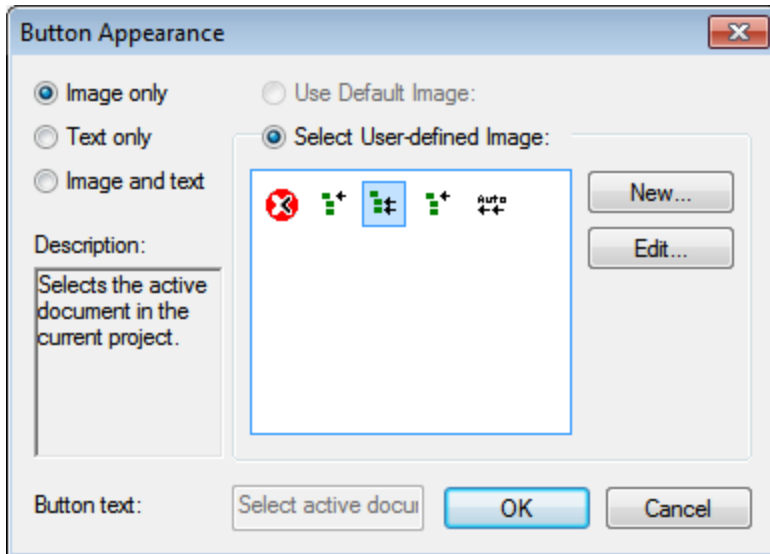

The following editing functionality is available for the selected toolbar icon (the one that was right-clicked to get the Customize context menu):

- *Image only, Text only, Image and text*: Select the desired radio button to specify what form the toolbar icon will take.
- *Image editing*: When *Image only* or *Image and text* is selected, then the image editing options are enabled. Click **New** to create a new image that will be added to the user-defined images in the images pane. Select an image and click **Edit** to edit it.

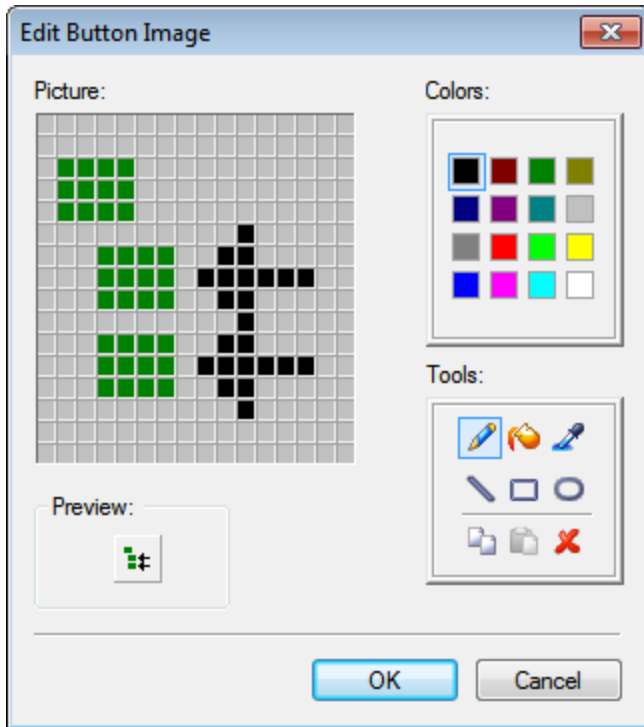

- *Image selection:* Select an image from the Images pane and click OK to use the selected image as the toolbar icon.
- *Text editing and selection:* When *Text only* or *Image and text* is selected, then the *Button Text* text box is enabled. Enter or edit the text and click **OK** to make this the text of the toolbar icon.

Note: The Button Appearance dialog can also be used to edit the text of menu commands. Right-click the menu command (with the Customize dialog open), click **Button Appearance**, and then edit the menu command text in the *Button Text* text box.

Restoring deleted menus, menu commands, and toolbar icons

If a menu, menu command, or toolbar icon has been deleted by using the **Delete** command in the Customize context menu, these can be restored as follows:

- *Menus:* Go to [Tools | Customize | Menu](#) ¹⁰³¹, and click the **Reset** button in the *Application Frame Menus* pane. Alternatively, go to [Tools | Customize | Toolbars](#) ¹⁰²⁴, select *Menu Bar*, and click the **Reset** button.
- *Menu commands:* Go to [Tools | Customize | Commands](#) ¹⁰²³, and drag the command from the *Commands* list box into the menu.
- *Toolbar icons:* Go to [Tools | Customize | Commands](#) ¹⁰²³, and drag the command from the *Commands* list box into the toolbar.

25.14.13 Restore Toolbars and Windows

The **Restore Toolbars and Windows** command closes down XMLSpy and re-starts it with the default settings. Before it closes down a dialog pops up asking for confirmation about whether XMLSpy should be closed (*screenshot below*).

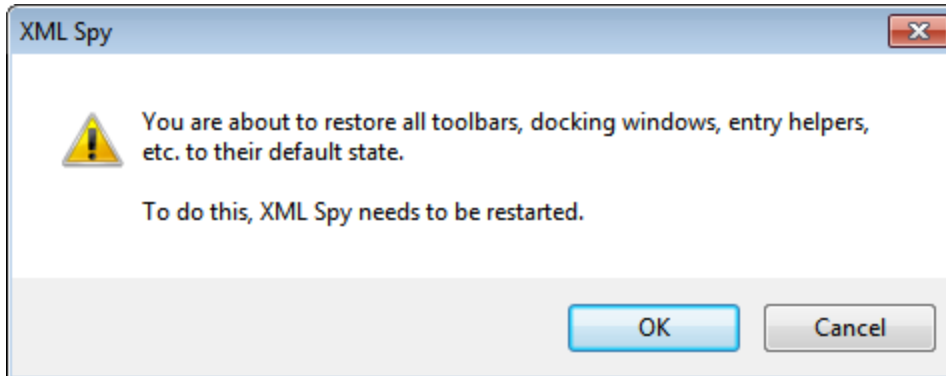

This command is useful if you have been resizing, moving, or hiding toolbars or windows, and would now like to have all the toolbars and windows as they originally were.

25.14.14 Options

The **Tools | Options** command enables you to define global application settings. These settings are organized in sections (*see left pane in screenshot below; note that XBRL options are available in the Enterprise Edition only*). For example, the [File section](#)¹⁰⁴¹ (*shown in the screenshot below*) contains options that specify how you want XMLSpy to open and save files. To specify options of a particular section, select that section in the left pane and specify the property values you want. The **OK** button saves changes to the registry and closes the dialog. The **Apply** button causes changes to be displayed in currently open documents.

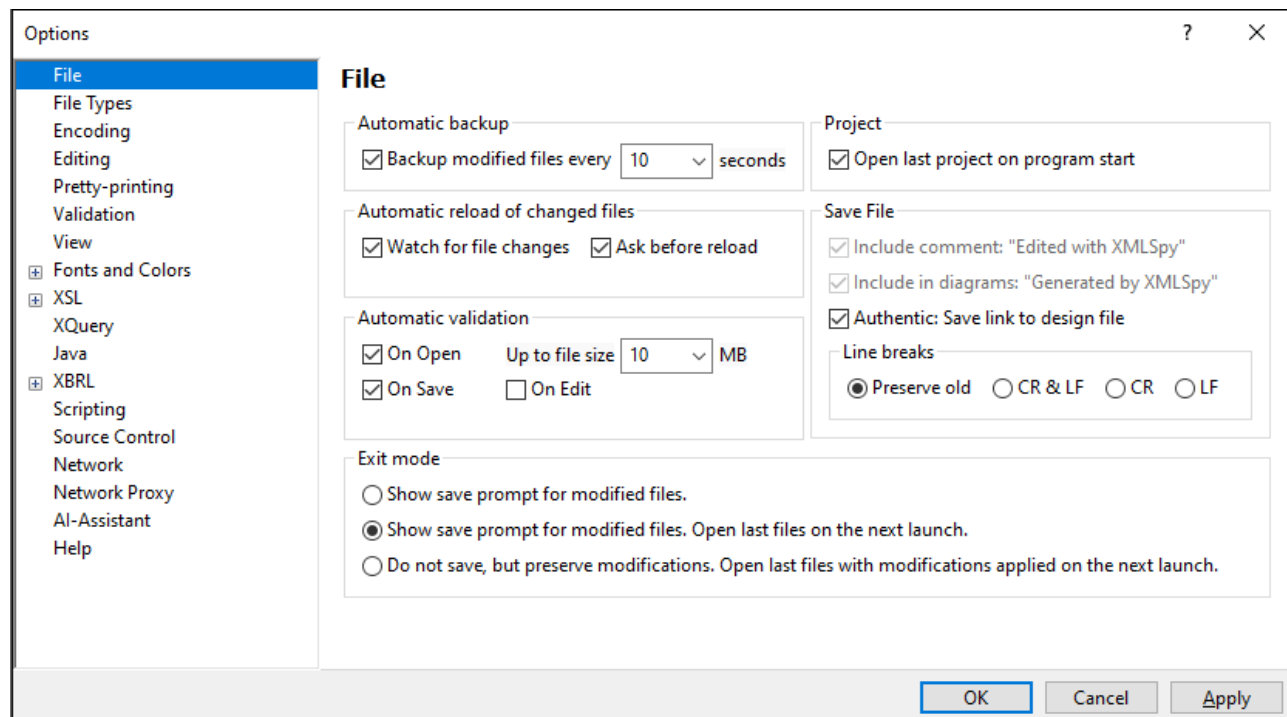

Each section of the Options dialog is described in detail in its sub-section of this section.

25.14.14.1 File

The **File** section defines the way XMLSpy opens and saves documents. Related settings are in the [Encoding section](#)¹⁰⁴⁶.

File

Automatic backup

 Backup modified files every seconds

Project

 Open last project on program start

Automatic reload of changed files

 Watch for file changes Ask before reload

Save File

 Include comment: "Edited with XMLSpy"
 Include in diagrams: "Generated by XMLSpy"
 Authentic: save link to design file

Automatic validation

 On Open Up to file size MB
 On Save On Edit

Line breaks

 Preserve old CR & LF CR LF

Exit mode

 Show save prompt for modified files.
 Show save prompt for modified files. Open last files on the next launch.
 Do not save, but preserve modifications. Open last files with modifications applied on the next launch.

Automatic backup

Files that you are currently editing will be automatically backed up if this option is enabled. You can select a backup frequency from between 5 seconds to 60 seconds in the combo box or enter a custom value up to 300 seconds. For more information, see the section [Automatic Backup of Files](#)¹²⁸.

Automatic reload of changed files

If you are working in a multi-user environment, or if you are working on files that are dynamically generated on a server, you can watch for changes to files that are currently open in the interface. Each time XMLSpy detects a change in an open document, it will prompt you about whether you want to reload the changed file.

Automatic Validation

If you are using DTDs or XML Schemas to define the structure of your XML documents, you can automatically validate your instance documents in the following situations:

- On opening the file if the file has a size below a size you specify in MB
- On saving the file
- While editing the file. If this option is selected, validation will be carried out as you type in [Text View](#)¹³⁰ or [Grid View](#)¹⁵⁹. For more information, also see [XML validation in Text View](#)²⁹⁴.

If the document is not valid, an error message will be displayed. If it is valid, no message will be displayed and the operation will proceed without any notification.

Project

When you start XMLSpy, you can open the last-used project automatically.

Save File

When saving an XML document, XMLSpy includes a short comment `<!-- Edited with XMLSpy http://www.altova.com -->` near the top of the file. This option can only be deactivated by licensed users, and takes effect when editing or saving files in the Enhanced Grid or Schema Design View.

When saving a content model diagram (using the menu option **Schema design | Generate Documentation**), XMLSpy includes the XMLSpy logo. This option can only be deactivated by licensed users.

If a StyleVision Power Stylesheet is associated with an XML file, the 'Authentic: save link to design file' option will cause the link to the StyleVision Power Stylesheet to be saved with the XML file.

Line breaks

When you open a file, the character coding for line breaks in it are preserved if **Preserve old** is selected. Alternatively, you can choose to code line breaks in any of three codings: **CR&LF** (for PC), **CR** (for MacOS), or **LF** (for Unix).

Exit mode

These options determine how to handle files that are open when XMLSpy is exited. The following options are available:

- *Show save prompt for modified files:* If an open file contains unsaved modifications, a prompt will appear asking whether you want to save the file modifications. Depending on your response, the file is saved or not saved, and the program is subsequently exited.
- *Show save prompt for modified files. Open last files on the next launch:* The Save dialog appears for open files that contain unsaved modifications. The user can save one or more modified files or not. When the program is relaunched after the exit, all the files that were open on exit will be opened on the relaunch. (If modifications had not been saved, then they would be lost.)
- *Do not save, but preserve modifications. Open last files with modifications applied on the next launch:* The program exits directly without saving unsaved modifications. On relaunch of the program, all files that were open on exit will be opened on relaunch, and they will contain the unsaved modifications. It would be as if you were continuing where you left off.

When you exit the program for the first time, the Exit Mode options are presented so that you can choose the exit behavior you want. Thereafter, the options are available in the File section of the Options dialog.

Save and exit

After making the settings, click **OK** to finish.

25.14.14.2 File Types

The **File Types** section (*screenshot below*) allows you to customize the behavior of XMLSpy on a per-file-type basis. (*Note that, in the screenshot below, some options, such as those related to XBRL and Avro support, are available in the Enterprise Edition only.*)

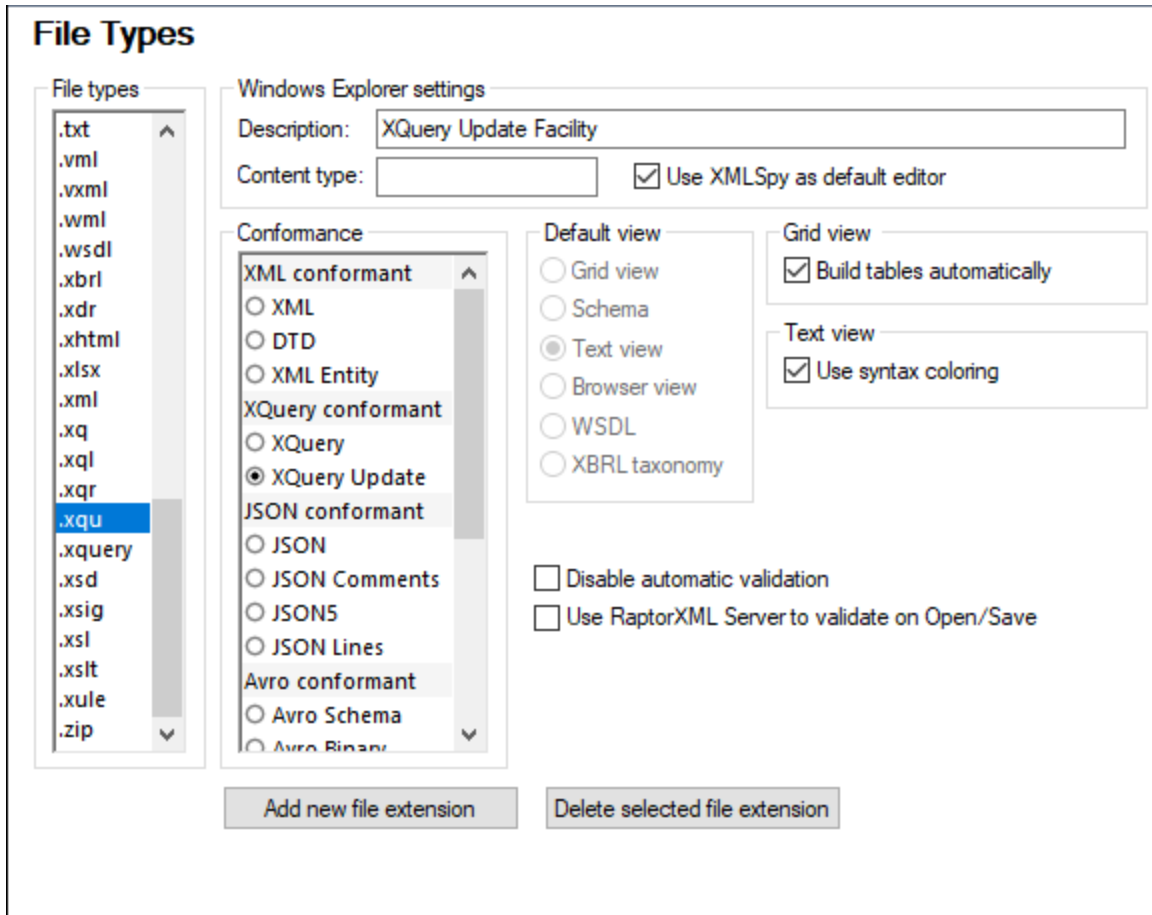

Choose a file type from the File Types list box, and then customize the functions for that particular file type as described below. Note that there are two special entries in the File Types list:

- `<default>` can be used to specify the treatment of files which have any extension that is not in the file-type list.
- `<none>` can be used to specify the treatment of files that have no extension at all.

Windows Explorer settings

You can define the file type description and MIME-compliant content type used by Windows Explorer and whether XMLSpy is to be the default editor for documents of this file type.

Conformance

XMLSpy provides specific intelligent editing features, as well as other features, for different file types. XMLSpy sets the features for a particular file type on the basis of the conformance you set in this option. For example, in the screenshot above, files with the `.xqu` file extension are set to be conformant to XQuery Update. XMLSpy will therefore open `.xqu` files with XQuery Update editing support. XMLSpy lets you set the following conformance options: XML, [XQuery](#)³⁷⁴, [ZIP](#)⁶⁰¹, [JSON](#)⁶⁰⁷, other formats. XML conformance is further differentiated between XML, DTD, and XML Entity file types. A large number of file types are defined with a

default conformance that is appropriate for the file type. We recommend that you do not modify these settings unless you are adding a new file type or deliberately wish to set a file type to another kind of conformance.

Default view

This group lets you define the default view to be used for each file type. The screenshot above shows the *File types* section of the Enterprise edition. If your edition is not the Enterprise edition, it will have fewer views than shown in the screenshot. If a particular conformance can be viewed in one view only, then that view is selected by default and view selection is disabled. For example, XQuery Update documents can only be viewed in Text View, so this view is selected by default and view selection is disabled.

Grid View

This check box lets you define whether the Grid View should automatically build tables.

Text View

This check box lets you set syntax-coloring for particular file types.

Disable automatic validation

This option enables you to disable automatic validation per file type. Automatic validation typically takes place when a file is opened or saved, or when a view is changed.

Use RaptorXML Server to validate on Open/Save

Specifies whether RaptorXML Server should be used to validate files of the selected file type when the file is opened and saved. For this to work, a [RaptorXML Server must be set up and configured](#)¹⁰¹⁹.

Add new file extension

Adds a new file type to the File types list. You must then define the settings for this new file type using the other options in this tab.

Delete selected file extension

Deletes the currently selected file type and all its associated settings.

Save and exit

After making the settings, click **OK** to finish.

25.14.14.3 Encoding

The **Encoding** section specifies options for file encodings.

Encoding

Default encoding for new XML files

Unicode UTF-8

Little-endian byte order

Big-endian byte order

Open XML files with unknown encoding as

Unicode UTF-8

Open non-XML files in

Codepage 1252 (Western)

BOM

Always create BOM if not UTF-8

Preserve detected BOM on saving

Default encoding for new XML files

The default encoding for new XML files can be set by selecting an option from the dropdown list. A new document is created with an XML declaration containing the encoding value you specify here. If a two- or four-byte encoding is selected as the default encoding (i.e. UTF-16, UCS-2, or UCS-4) you can also choose between little-endian and big-endian byte-ordering.

The encoding of existing XML files will be retained and can only be changed with the [File | Encoding](#)⁷⁹² command.

Open XML files with unknown encoding as

If the encoding of an XML file cannot be determined or if the XML document has no encoding specification, the file will be opened with the encoding you select in this combo box.

Open non-XML files in

Existing and new non-XML files are opened with the encoding you select in this combo box. You can change the encoding of the document by using the [File | Encoding](#)⁷⁹² command.

BOM (Byte Order Mark)

When a document with two-byte or four-byte character encoding is saved, the document can be saved either with (i) little-endian byte-ordering and a little-endian BOM (*Always create BOM if not UTF-8*); or (ii) the detected byte-ordering and the detected BOM (*Preserve detected BOM on saving*).

Save and exit

After making the settings, click **OK** to finish.

25.14.14.4 Editing

The **Editing** section enables you to specify editing behavior in XMLSpy.

Editing

Show entry helpers

Load entry helpers upon opening file

Sort: Attributes Elements

Mandatory first: Attributes Elements

Auto-append mandatory children to new elements

First branch of choice

All branches of choice (may take a long time and make the result invalid)

Branch of choice with the smallest number of elements

Generate non-mandatory Elements

Generate non-mandatory Attributes

Treat element content of nillable elements as non-mandatory

For elements with an abstract type, try to use a non-abstract type for xsi:type

Auto-complete in Text View

Disable auto-completion and entry helpers if file size is bigger than MB

Entry helpers

While editing documents, XMLSpy provides intelligent editing based on these settings. You can customize various aspects of entry helper behavior in this pane, including the order in which items appear in the entry helpers. The customization settings made here will be applied when relevant to the file type being edited. For example, the option to load entry helpers on opening the file and sorting attributes will not be applicable to DTD or XQuery documents.

Creating XML structure from XML Schema

When you create a new XML document that is based on an XML Schema, the document will be generated with a structure that is derived from the definitions in the schema. The settings described below determine some ambiguous aspects related to the creation of this structure.

Auto-append mandatory children

Mandatory child elements of `choice` groups in the schema are auto-appended on the basis of the setting made in this pane. You can select whether (i) the first branch (element) of the `choice` group, (ii) all branches, or (iii) the branch with the smallest number of descendant elements is generated. Note that the *All branches* selection could generate an invalid document since only one branch from a `choice` group is allowed.

Non-mandatory nodes and elements of an abstract type

To add non-mandatory elements or attributes, select the respective option. If these options are not selected, then only mandatory nodes will be added. You can also (i) set element content of nillable elements to be non-mandatory, and (ii) try to use a non-abstract type as the `xsi:type` of an element of an abstract type.

Text View

The *Auto-complete* option automatically adds unambiguous structural components. For example, when the closing angular bracket of the start tag of an element is entered, then the end tag of that element is automatically added if this option is enabled.

In Text View, Auto-completion and entry helpers can be disabled if a file is bigger than the size specified in the *Disable Auto-completion* combo box. This is useful if you wish to speed up the editing of large files and can do without the auto-completion feature and entry helpers. If the file size is bigger than that specified for this option, then the Text View context menu contains a toggle command for switching on and off Auto-completion and entry helper use. So you can always switch these editing aids on and off at any time during editing (in the event of files having a size greater than the size specified for this option). If the value specified for this option is smaller than the size of the opened file, locations indicated in error messages will not correctly correspond to the location in Text View.

Save and exit

After making the settings, click **OK** to finish.

25.14.14.5 Pretty Printing

The **Pretty Printing** section (see *screenshots below*) enables you to specify how text is displayed in Text View. The definitions in this section are grouped into the following categories:

- XML settings (select the XML tab)
- JSON settings (select the JSON tab)
- YAML settings (select the YAML tab)
- Text View Settings (click the button to access the settings dialog)

The *Use indentation* check box switches [pretty-printing](#)¹³¹ on/off. The *Automatically pretty-print in Text View* check box can be selected to automatically apply pretty-printing when a document is loaded.

XML settings

The XML settings are in the XML tab and are described below the screenshot.

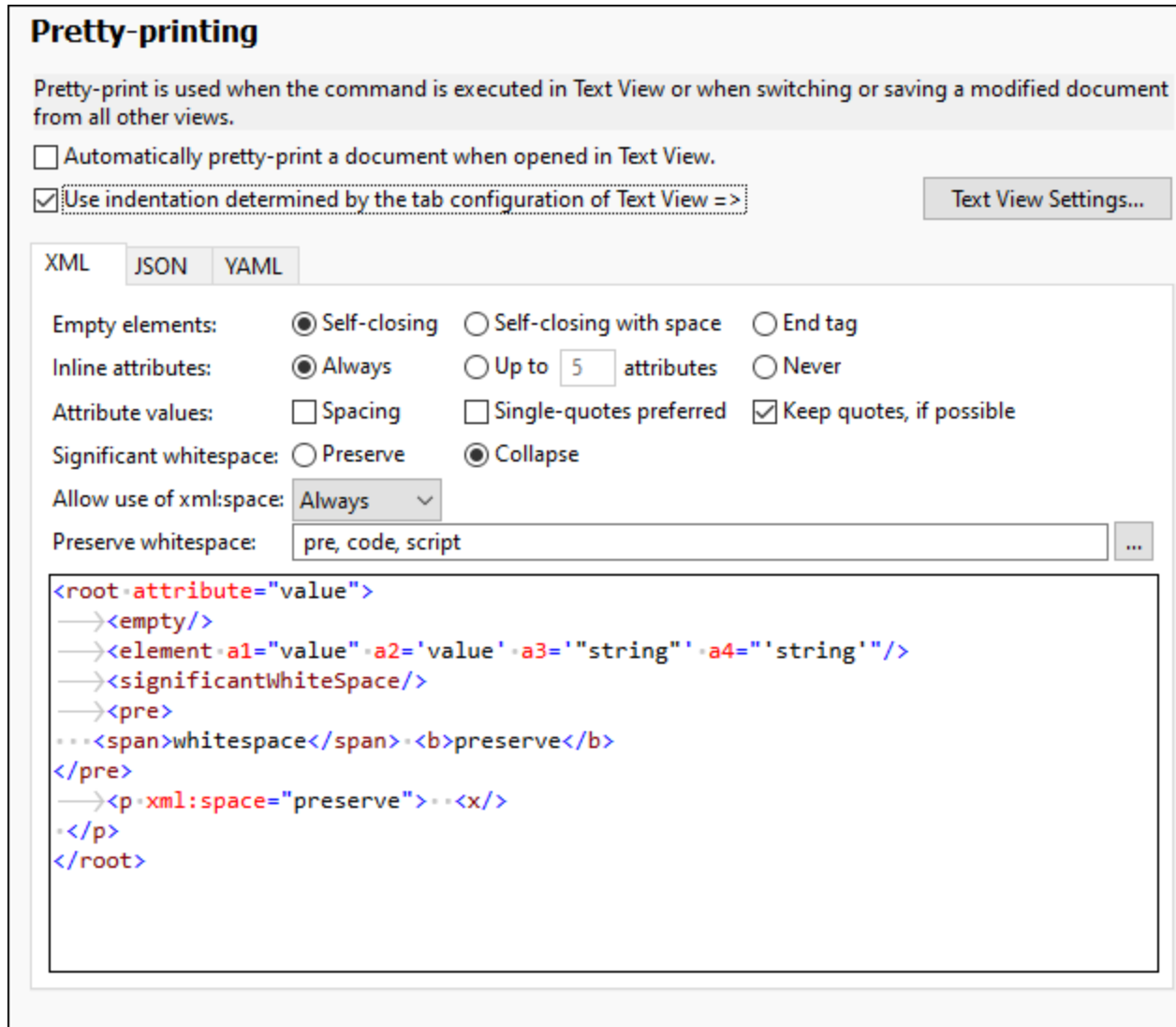

When you select an option, its effect is displayed in the preview pane at the bottom of the dialog, which allows you to see the effect before you confirm with **OK**. You can specify via the check box above the XML tab whether to use the indentation specified in the [Text View Settings](#)⁹⁹⁵ dialog or whether to use no indentation at all.

- How empty elements are written and displayed in the document: with one tag (*Self-closing*) or two tags (*End tag*).
- Whether attributes are displayed inline (on the same line as its parent element) or not. Attributes are displayed inline if *Always* is selected, or if *Up to X attributes* is selected and the number of attributes does not exceed X. Attributes are shown on new lines if *Never* is selected or if *Up to X attributes* is selected and the number of attributes does not exceeds X.
- How attribute values are written: (i) with spaces on either side of the equals sign or not; (ii) whether values are enclosed in single quotes or double quotes; (iii) whether quotes in the source text are preserved as entered by you, or whether they are overridden by other options (such as *Single-quotes Preferred*); note that, if selected, *Keep quotes* is applied only as far as it is possible to do so without invalidating the document.

- Whether to preserve or collapse whitespace. Whitespace characters are: space, tab, carriage return, and line feed. See the section [Whitespace](#)²⁹⁶ for details.
- If elements in a document contain the `xml:space="preseve"` attribute-value pair, then you can specify, with the *Allow use of xml:space* setting, how this attribute-value pair should be treated when pretty-printing. The *Always* option specifies that the attribute's intention is to be followed during pretty-printng of any document: whitespace in the respective elements will be preserved and these elements will not be pretty-printed. The *Never* option causes the `xml:space` attribute to be ignored and the respective elements to be pretty-printed. The *Ask* option causes XMLSpy to ask what should be done every time a document containing `xml:space="preseve"` is pretty-printed.
- Set which elements will preserve whitespace.
- Whether the indentation specified in the [Text View Settings](#)⁹⁹⁵ dialog is used or whether no indentation is used (specified via the check box above the pane).

JSON settings

The JSON settings are in the JSON tab and are described below the screenshot.

Pretty-printing

Pretty-print is used when the command is executed in Text View or when switching or saving a modified document from all other views.

Automatically pretty-print a document when opened in Text View.

Use indentation determined by the tab configuration of Text View => Text View Settings...

XML **JSON** YAML

Inline array: Never Empty only Up to items

Inline object: Never Empty only Up to members

Inline padding Single quoted strings (json5)

Inline padding empty Unquoted keys (json5)

```

{
  → "array": [
  → → 1,
  → → 2,
  → → 3
  → ],
  → "empty array": [
  → ],
  → "object": {
  → → "key": "value"
  → },
  → "empty object": {
  → }
}
```

For every option you select, the effect is shown immediately in the preview pane at the bottom of the dialog. You can specify via the check box above the JSON tab whether to use the indentation specified in the [Text View Settings](#) ⁹⁹⁵ dialog or whether to use no indentation at all.

- *Inline Array*: Displays the items of an array in a single line (or inline). You can choose to (i) never apply inline formatting, (ii) apply inline formatting to empty arrays only, (iii) apply inline formatting to arrays up to a specific size. If the size of an array is greater than the size you select, then the items are each displayed on a separate line.
- *Inline Object*: Displays the properties of an object in a single line (or inline). You can choose to (i) never apply inline formatting, (ii) to apply inline formatting to empty objects, or (iii) apply inline formatting to objects that have up to a specified number of properties. If the size of an object is greater than the size you select, then the properties of the object are each displayed on a separate line.
- *Inline Padding*: If selected, adds space between the elements of non-empty inline arrays and non-empty inline objects. The option is enabled only if either the non-empty *Inline Array* or non-empty *Inline Object* option has been selected.
- *Inline Padding Empty*: If selected, adds space inside the delimiters of empty inline arrays and empty inline objects. The option is enabled only if either an array or object is set to be inline (empty or non-empty).
- *Single Quoted Strings (JSON5)*: If selected, converts all quotes in JSON5 documents to single quotes.
- *Unquoted Strings (JSON5)*: If selected, removes, in JSON5 documents, quotes from around all keys (of `key:value` pairs).

YAML settings

The YAML settings are in the YAML tab and are described below the screenshot.

Pretty-printing

Pretty-print is used when the command is executed in Text View or when switching or saving a modified document from all other views.

Automatically pretty-print a document when opened in Text View.

Use indentation determined by the tab configuration of Text View => Text View Settings...

XML
JSON
YAML

Inline sequence: Empty only Up to items

Inline mapping: Empty only Up to entries

Inline padding Quoted strings

Inline padding empty Use single quotes

```
array:
  .....-1
  .....-2
  .....-3
empty-array: -[]
object:
  ....key: value
empty-object: -{}
```

For every option you select, the effect is shown immediately in the preview pane at the bottom of the dialog. You can specify via the check box above the YAML tab whether to use the indentation specified in the [Text View Settings](#) ⁹⁹⁵ dialog or whether to use no indentation at all.

- *Inline Sequence*: Displays the items of a sequence in a single line (or inline) if the sequence either (i) is empty or (ii) has up to the number of items you specify. Sequences with more items than the number corresponding to the option you select will have each item on a separate line.
- *Inline Mappings*: Displays the mappings of an object in a single line (or inline) if the object either (i) is empty or (ii) has up to the number of items you specify. Objects with more mappings than the number corresponding to the option you select will have each mapping on a separate line.
- *Inline Padding*: If selected, adds space between the items of non-empty inline sequences and non-empty inline mappings. The option is enabled only if either the non-empty *Inline Sequence* or non-empty *Inline Mapping* option has been selected.
- *Inline Padding Empty*: If selected, adds space inside the delimiters of empty inline sequences and empty inline mappings.
- *Quoted Strings*: If selected, adds quotes around all strings.
- *Use Single Quotes*: If selected, converts all quotes to single quotes.

Text View settings

Click **Text View Settings** to open the Text View Settings dialog, where you can enable properties of Text View such as indentation, bookmark margins, and auto-highlighting. The Text View Settings dialog can also be accessed via the menu command [View | Text View Settings](#)⁹⁹⁵. The dialog is described there.

Save and exit

After making the settings, click **OK** to finish.

25.14.14.6 Validation

The **Validation** section enables you to specify options for validating XML and JSON documents.

Validation

XML

Cache DTD/Schema files in memory

Schema Version

v1.1 if `<xs:schema vc:minVersion="1.1" ... >`
v1.0 otherwise

Always v1.1

Always v1.0

JSON

Validate format

Strict integer check

Message limits

Errors:

Inconsistencies:

Warnings:

XML

XMLSpy can cache DTD and XML Schema files in memory to save unnecessary reloading (for example, when the schema is not local but is accessed via a URL). Note, however, that if you use cached versions of schemas, changes you make to your schema will not be immediately reflected when you validate; in this case, you would need to reload the XML file or restart XMLSpy.

Schema Version

The XSD mode that is enabled in Schema View depends on both (i) the presence/absence—and, if present, the value—of the `/xs:schema/@vc:minVersion` attribute of the XSD document, and (ii) the XML Schema Version option selected in the File section of the Options dialog (**Tools | Options**, *screenshot below*).

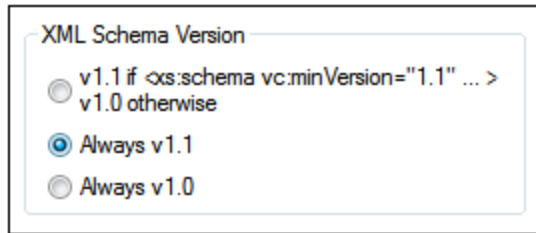

The following situations are possible. *XML Schema Version* in the table below refers to the selection in the XML Schema Version pane shown above. The `vc:minVersion` values in the table refer to the value of the `xs:schema/@vc:minVersion` attribute in the XML Schema document. For more details, see the section [Editing Views | Schema View | XSDMode](#)²⁰⁰.

| XML Schema Version | <code>vc:minVersion</code> attribute | XSD mode |
|--------------------------------|--|----------|
| <i>Always v1.0</i> | Is absent, or is present with any value | 1.0 |
| <i>Always v1.1</i> | Is absent, or is present with any value | 1.1 |
| <i>Value of @vc:minVersion</i> | Attribute has value of 1.1 | 1.1 |
| <i>Value of @vc:minVersion</i> | Attribute is absent, or attribute is present with a value other than 1.1 | 1.0 |

Message limits

These options enable you to set separate limits for the number of errors, XBRL inconsistencies, and warnings that are displayed. The default number for each category is 100. Change it to the number you want.

JSON

The following validation options are available for JSON document validation:

- *Validate format*: The [format of string types](#)⁵⁴⁶ in JSON instance documents is validated.
- *Strict integer check*: There are two JSON numeric types: `number` and `integer`. This option check that integers are of an integer type (and not, for example, floating point numbers (for example, 7.0), or signed (for example, +7), or strings (for example, "7")).

Save and exit

After making the settings, click **OK** to finish.

25.14.14.7 View

The **View** section enables you to customize the XML documents presentation in XMLSpy.

Program logo

You can turn off the splash screen on program startup to speed up the application. Also, if you have a purchased license (as opposed to, say, a trial license), you will have the option of turning off the program logo, copyright notice, and registration details when printing a document from XMLSpy.

Window title

The window title for each document window can contain either the file name only or the full path name.

Text View settings

Click **Text View Settings** to open the Text View Settings dialog, where you can enable properties of Text View such as indentation, bookmark margins, and auto-highlighting. The Text View Settings dialog can also be accessed via the menu command [View | Text View Settings](#)⁹⁹⁵. The dialog is described there.

Grid View settings

Click **Grid View Settings** to open the Grid View Settings dialog. The following options for Grid View can be set:

Grid View settings are described below. Note that these settings apply to the Grid View of all documents (XML, JSON, DTD).

Grid View Settings [X]

Display

- Expand all cells on loading
- Convert XML entities to Raw text on loading
- Show inline previews for attributes only in XML
- Automatically provide optimal cell widths
- Limit optimal cell width to pixels
- Limit cell height to pixels
- Display of text overflow:
- Display whitespace:
- Maximum amount of nodes per sibling group:

Navigation

- Expand on → (right arrow) key
- Collapse on ← (left arrow) key
- Expand/Collapse on spacebar
- Keep column position on ↑↓ (up/down arrow) key

Editing

- Change type of all selected cells simultaneously:
- Keep json value when changing type to object/array:
- Paste direction for inserted items:

Persistence

- Store formulas in document (if possible)

JSON Tables

- Detect tables automatically on loading
- Minimum amount of filled value cells: %

XML Tables

- Detect tables automatically on loading
- Minimum amount of filled value cells: %

Clipboard

- Default copy to clipboard for table value cells:

Display

The check boxes in the *Display* section are fairly self-explanatory. Given below are a few notes for clarification.

- If all cells are not expanded on loading, then the root node and all its descendants are collapsed. You will need to expand each node as you go deeper into the document.
- If *Convert XML entities to raw text on loading* is selected, then XML entities will be loaded in Grid View as the raw text of the respective entity; they will not be resolved to their respective glyph representations.
- If *Show inline previews* is not checked, then, instead of a preview of the cell being shown, only the index number of the element in the cell will be shown. If inline previews are enabled, then you can opt to show a preview that contains (i) both element content and attributes, or (ii) attributes only. To opt for the latter, check *For attributes only*; to opt for the former, uncheck *For attributes only*. Note that only the first part of the inline content of a cell will be shown; you can hover over an element's start tag to see all of its content.
- When optimal widths are switched on, the entire width of the grid is displayed. To achieve this, text in some cells will wrap.
- When text overflows a cell, the overflow can be shown either as text that fades or be indicated by an ellipsis.
- You can switch the display of whitespace in grid cells on or off. A space character is shown as a vertically centered dot and a tabs is displayed as an arrow. An end-of-line is indicated with a new linefeed inside the cell.
- Sibling nodes can be organized into sibling groups of 100, 1k, or 10k nodes (*see screenshot below*). This is useful for two reasons: (i) saving space in the display and aiding navigation; (ii) avoiding a delay in rendering that loading a large number of records would entail. At any time, one sibling group is shown expanded. This group can be collapsed only by expanding another group. If you do not want to group siblings, then select *Unlimited*.

| | | | |
|--------------------------|--|------------|-----------|
| 9998 | 52579269 | 42.454218 | 1.4706366 |
| 9999 | 52579270 | 42.4542084 | 1.4707958 |
| 10000 | 52579271 | 42.4541842 | 1.4709068 |
| ▼ <> node <10001..20000> | | | |
| ▼ <> node <20001..30000> | | | |
| ▼ <> node <30001..40000> | | | |
| ▼ <> node <40001..50000> | | | |
| ▼ <> node <50001..60000> | | | |
| ▼ <> node <60001..70000> | | | |
| ▼ <> node <70001..74427> | | | |
| ▼ <> way (2987) | <way id="6165450" version="12" timestamp="2011-05-17T16:00:08Z" cha | | |
| ▼ <> relation (79) | <relation id="7439" version="186" timestamp="2013-08-27T13:50:01Z" cha | | |

Groups of 10k nodes

Navigation

Basically, you can use the arrow keys to navigate the grid. These settings provide smart options for using the keys.

- *Expand on Right Arrow key*: If a cell item is collapsed, then pressing the *Right Arrow* key expands the item in the cell. If the cell item is not collapsed, the *Right Arrow* key takes you to the next cell on the right (including to the child if the next cell on the right is a child). If the option is not selected, the *Right Arrow* key stops at a collapsed cell. Note that the *Expand on Right Arrow key* feature does not apply to cells within tables; in table cells, the action takes you to the next cell on the right.
- *Collapse on Left Arrow key*: When you move left with the *Left Arrow* key, then, at some points, you

must also move up the document hierarchy. If this option is selected, then items that can be collapsed will be collapsed when the *Left Arrow* key is pressed; otherwise such items will not be collapsed although the focus will shift to the parent item. Note that the *Collapse on Left Arrow key* feature does not apply to cells within tables; in table cells, the action takes you to the next cell on the left.

- *Expand/Collapse on Spacebar*: The spacebar functions as a toggle to expand/collapse an item. It can therefore be used as an additional key for navigating the grid.
- *Keep Column Position on Up/Down Arrow keys*: The *Up* and *Down Arrow* keys take you, respectively, up and down through cells of the grid, including through parent and children items—which are hierarchically at different levels, and so in different columns. If this option is selected, levels that are represented in columns other than the current column are skipped. This works, for example, like this. Say the cursor is in the column for the element `subject/course/books/book/title`. With the *Keep Column Position* option selected, you can use the *Up* and *Down* arrow keys to navigate only through titles of books (without going into the `book`, `books`, `course`, or `subject` columns, or any columns for descendant items of `title`.)

Editing

The check boxes in the *Display* section are fairly self-explanatory. Given below are a few notes for clarification.

- When changing the type of multiple selected cells, you are given the following options about whether to go ahead with the action of the setting: *Always*, *Never*, or *Ask* (for user decision).
- When changing a JSON type to from an atomic type to object or array, you are given the following options about whether to go ahead with the action of the setting: (i) *Ask* (whether the value of the atomic type should be retained as the value of an unnamed child `key:value` pair, or discarded), (ii) *Always* (retain the value in an unnamed child `key:value` pair), (iii) *Never* (retain the value, that is, discard the value).
- The *Paste direction* option determines whether a selection in the clipboard is pasted above or below the selected cell.

Persistence

Formula expressions and formula results are always stored in the application metadata file for filters and formulas. However, if the *Persistence* option is selected, then formulas can also be saved in the document itself.

- In XML documents, formula expressions are stored as processing instructions and formula results are stored as element content.
- In JSON5 and JSONC documents, formula expressions are stored as comments and formula results are stored as JSON properties.

The *if possible* terminology of the option refers to the fact that comments are allowed only in JSON5 and JSONC documents—not in other JSON documents.

JSON Tables. XML Tables

If the setting to detect Grid View tables automatically on loading is selected, then you can select the minimum percentage of filled table cells that qualify tables to be detected as tables. If the number of filled table cells does not exceed this level, then the structure is displayed as a normal grid with the repeating elements listed one below the other.

Clipboard

You can also choose whether clipboard contents should be stored as tab-separated values (TSV), or as XML/JSON (depending on the document type). This is a very useful feature: If you want to paste a table from the clipboard to another document, this setting enables you to choose whether the copied table is stored as TSV or with markup. (To see the difference, try pasting a table to a text editor after copying the table to the clipboard in each of the formats.)

Schema view

An XML Schema datatype can be derived from another datatype. For example, a datatype for E-mail elements can be derived from a base datatype of `xs:string` (for example, by restricting the `xs:string` datatype to a specific set of characters). If the base datatype is subsequently changed, you can set the following options:

- *Preserve content*: If the definitions used to define the derived type can be used with the new base type, checking this option will automatically preserve the definitions.
- *Confirm on every modification*: After changing the base type, a dialog (see screenshot below) will pop up asking whether the old definitions should be preserved and used with the new base type.

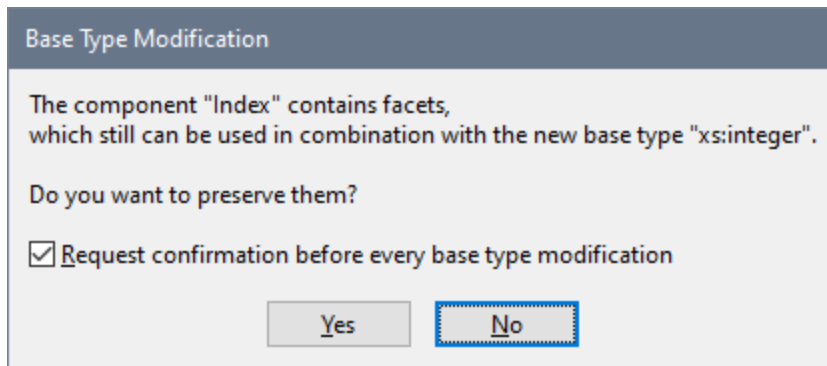

Authentic View

XML files based on a **StyleVision Power Stylesheet** are automatically opened in Authentic View when this option is active.

Browser View

You can choose to see the browser view in a separate window, enabling side-by-side placement of the edit and browser views.

Browser engine

The browser engine that is used in Authentic View and Browser View is currently Internet Explorer (IE), and IE is therefore the default browser engine for these two views. Alternatively, you can use Microsoft Edge Web View 2 as the engine for Browser View. If Edge is not installed on your machine, go to the [WebView2 download page](#), from where you can install the Evergreen Bootstrapper. This will enable you to use Microsoft Edge WebView2 as the engine for Browser View.

See the topic [Browser View](#)²⁷⁶ for more information.

Save and exit

After making the settings, click **OK** to finish.

25.14.14.8 Fonts and Colors

The **Fonts and Colors** section provides customization options for the appearance of text items in the various views of XMLSpy.

Note: The Fonts and Colors options apply to the currently active theme. To modify fonts and colors in another theme, make it the active theme before changing these options.

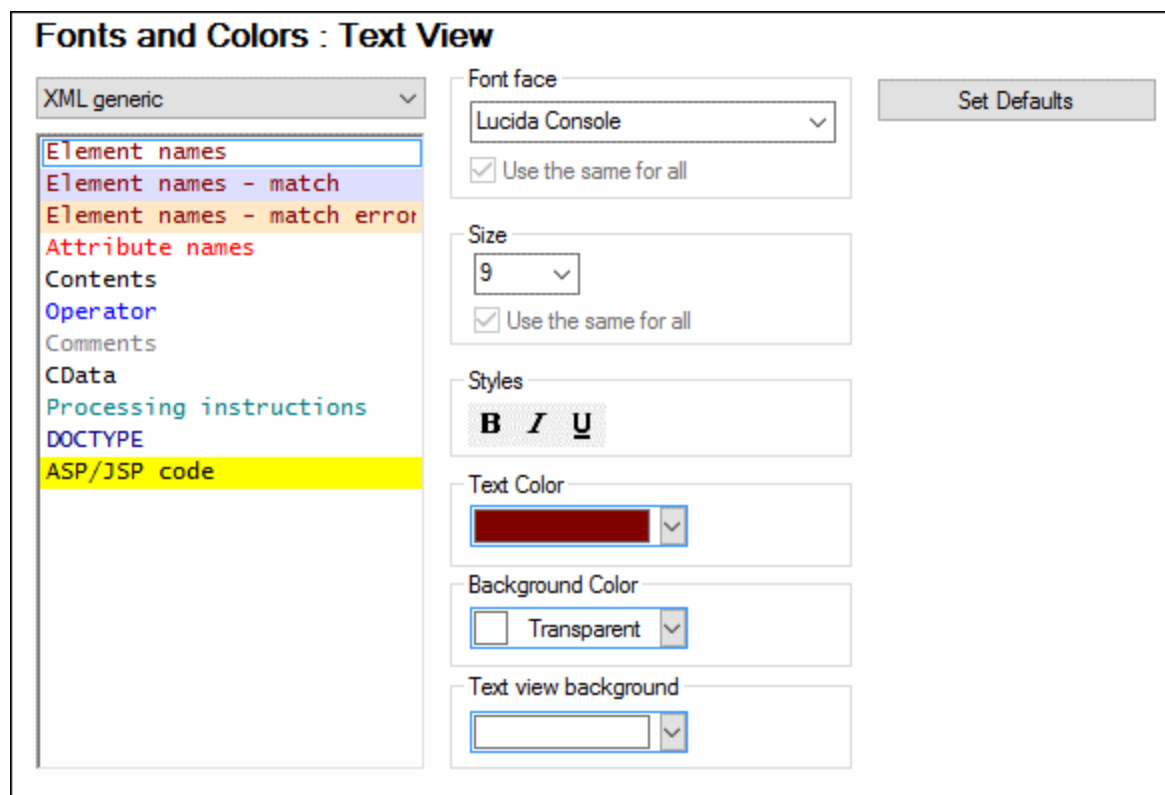

Options for the following views are available:

- [Text View](#)¹⁰⁶¹
- [Grid View](#)¹⁰⁶³
- [Schema Design View](#)¹⁰⁶⁵

In the left-hand pane of the dialog, select the view what you want to customize. The text item types that can be formatted are displayed in the right-hand pane (*screenshot above*). Select the text item type that you want to format, and then assign to it the desired formatting property values.

25.14.14.8.1 Text View

The **Text View** section enables you to customize, for the currently active theme, the appearance of individual text-item types in various types of documents (see *screenshot below and list of documents in Document Types section below*). For example, you can specify different formatting for the display of element names and attribute names in XML documents, or for the display of keywords and variables in XQuery documents.

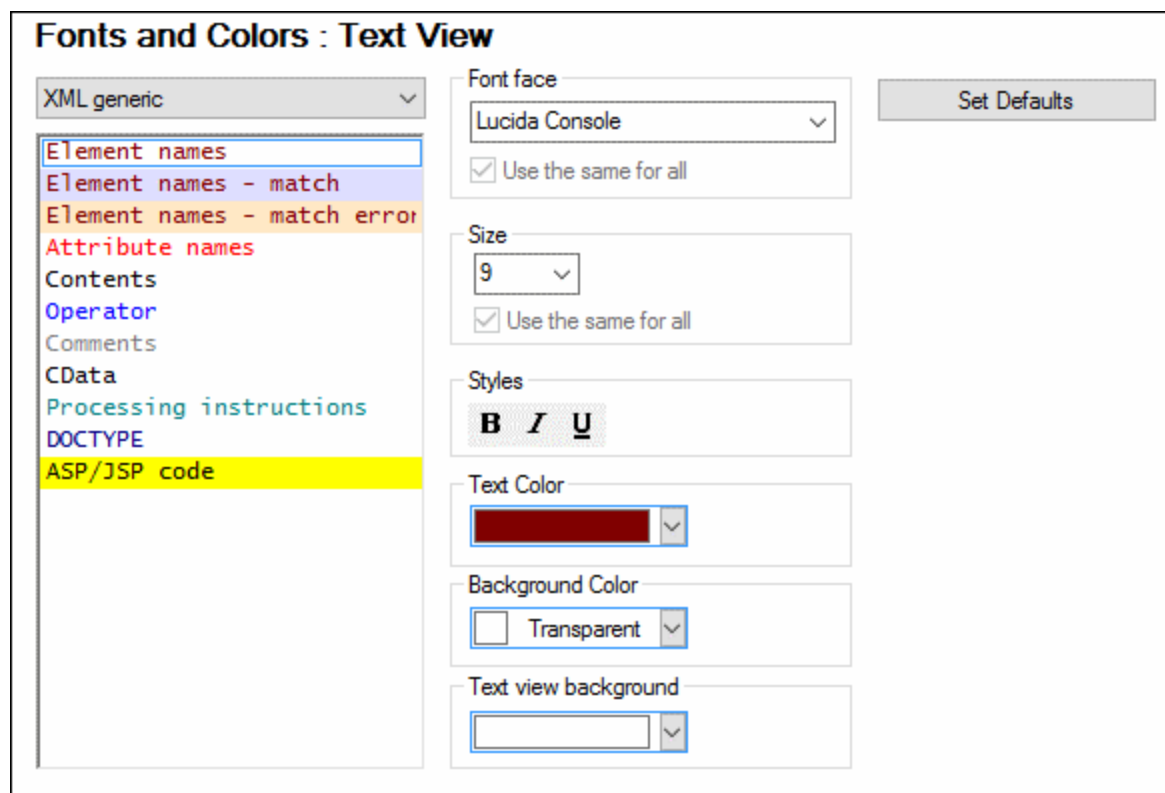

Note: Formatting will be set for the [currently active theme](#)¹⁰⁸⁰. To set the formatting of another theme, make the other theme the active theme.

Document types

You can select a specific document type in the combo box at top left of the dialog and then define the formatting of this document type's text items.

Text items of the following types of documents can be formatted:

- XML generic
- XQuery
- CSS
- JSON
- C-family
- Python
- Markdown
- YAML

- XULE
- Miscellaneous
- Output

How to customize

To customize individual text item types of a particular document type, do the following:

1. In the combo box at top left, select the type of document for which you wish to customize text. On doing this, the text item types of that document type appear in the box below the combo box. (*In the screenshot above, XML generic has been selected as the document type.*)
2. Select the text item type you wish to customize by clicking it. (*In the screenshot above, Element names has been selected.*)
3. Set the font properties of the selected text item type by using the options in the panes on the right-hand side. The *Text View Background* option enables the selection of a background color for the entire Text View.

Note the following points:

- The same font face, size, and style are used for **all text item types** of a particular document type (such as the XML generic document type). Within a document type, only the text color and background color of individual text types can be changed. This enables the syntax coloring feature.
- In the *Generic XML* category, the *Element names* text type consists of three subtypes: (i) *Element names* applies to element names that are not selected; (ii) *Element names - match* applies to those element names that are selected (names in which the cursor is placed) and where the start tag name matches the end tag name; (iii) *Element names - match error* applies to those element names that are selected, but where the start tag name does not match the end tag name. Element names that are being edited will therefore be highlighted with different background colors according to whether the start tag names match the end tag names or not. These highlight colors can be changed by changing the respective background colors. Highlighting is turned on by default, and can be turned off by deselecting the *Highlight elements* option in the [Text View Settings](#)⁹⁹⁵ dialog.
- In the *Miscellaneous* category: (i) *Selection* refers to the currently selected text content; *inactive selection* refers to other occurrences in the document of the same text content; (ii) *Find active marker* refers to the currently selected occurrence of a search result, whereas *Find marker* refers to other (inactive) occurrences of the search result; (iii) *Debug/Call marker* refers to the currently selected step in a debug session; (iv) *Visible Whitespace* refers to the whitespace markers in a document. The whitespace in a document can be made visible by [switching on whitespace markers](#)⁹⁹⁵.

Set defaults

The **Set Defaults** button resets fonts to the original installation settings.

Save and exit

After making the settings, click **OK** to finish.

25.14.14.8.2 Grid View

The **Grid View** section (*screenshot below*) allows you to customize the appearance of text in the [XML Grid View](#)¹⁴⁶ and [JSON Grid View](#)⁵²⁰. The *Cell Colors* option (*see screenshot*) enables you to set the colors of cells when grid components are displayed as tables. In the combo box, select the document display for which you want to configure Grid View. Then select the text item type you want to format and assign to it the desired formatting properties (*listed below*).

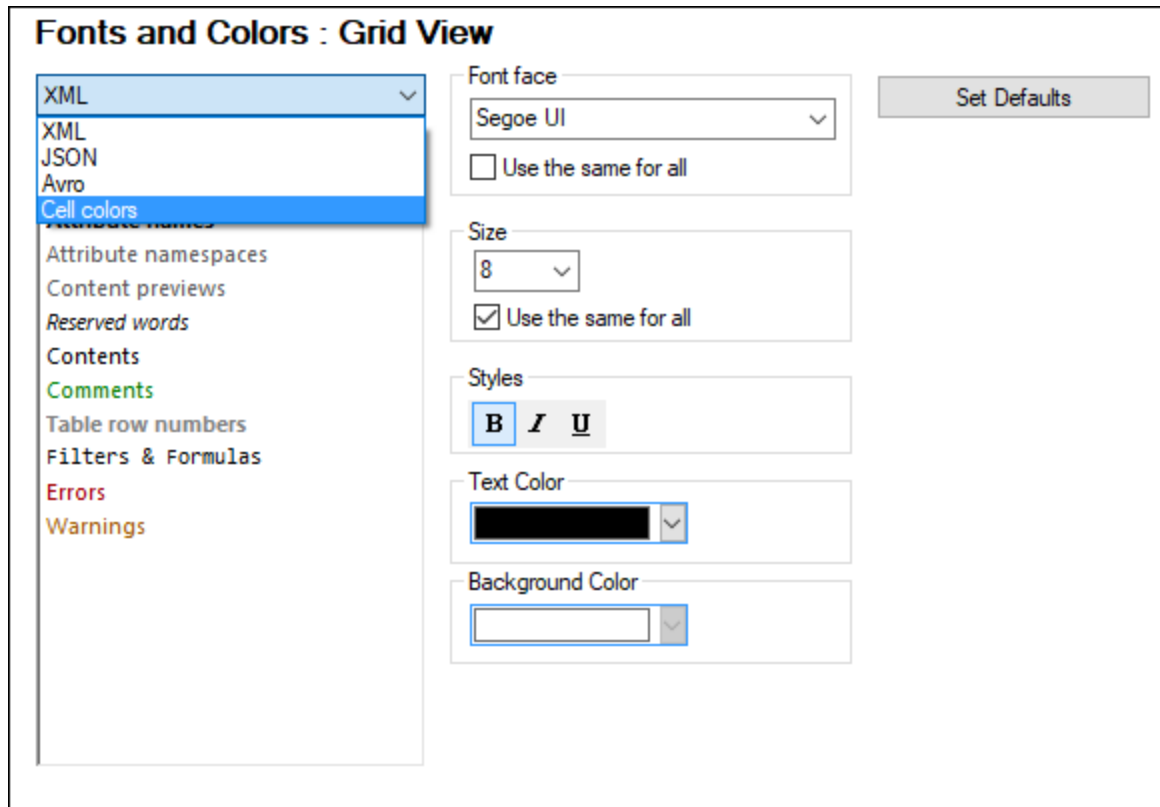

Note: Formatting will be set for the [currently active theme](#)¹⁰⁸⁰. To set the formatting of another theme, make the other theme the active theme.

XML Grid, JSON Grid

You can set the following properties for the selected text item type:

- **Font face and size:** The selected font will also be used in printouts of Grid View. If you want to use the same font face or size for all text item types, check the respective *Use the same for all* check box.
- **Text style, text color, text background:** Sets the style, color, and background of individual text item types. The current settings are immediately reflected in the list in the left-hand pane, so you can preview how the text item will look.

Cell Colors (of Table Displays in all Grids)

Table displays in all grids (XML, JSON) can be configured not only on the basis of their language-related semantics (for example, an XML element can be formatted differently than an XML comment). You can also

format Grid View on the basis of cell function: for example, to differentiate between the selected/unselected state of different table components. Such differentiation is best achieved by assigning different background colors to each item (see *screenshot below*), but you can also use other/additional formatting properties for different types of cell.

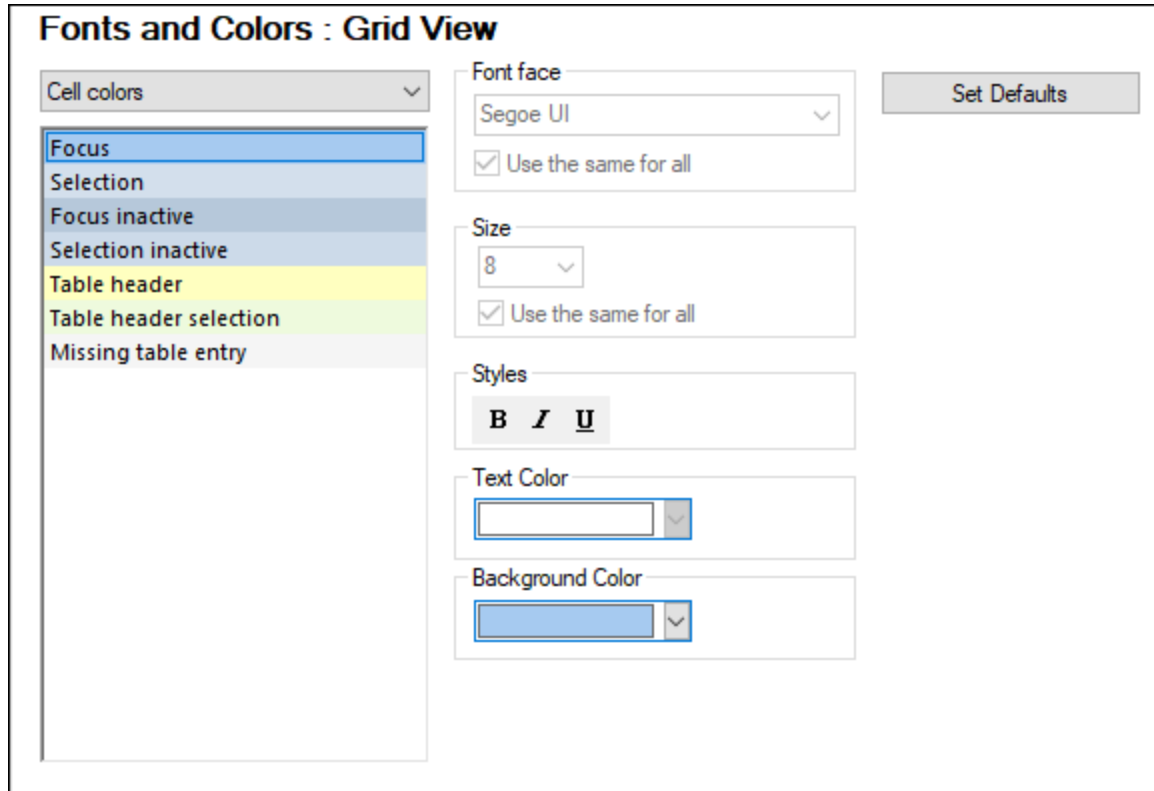

Settings for the following components are available:

- *Table Header (unselected) and Table Header Selection:* These refer to column and row headers. The screenshot below shows headers unselected; its background color is as set in the dialog above. The *Header Selected* color is activated when all headers are selected—not when an individual header is selected. All headers can be selected by clicking the cell that intersects the column and row headers, or by selecting the element created as the table—or any of its ancestors.

| <> Name | Administration | | |
|--------------|----------------|---------|---------------------|
| ▲ Person (3) | <> First | <> Last | <> Title |
| 1 | Vernon | Callaby | |
| 2 | Frank | Further | Accounts Receivable |
| 3 | Loby | Matise | Accounting Manager |

- *Missing Table Entry:* Refers to non-existent elements or attributes in the document (see *screenshot below*).
- *Selection and Focus:* Refers to the cells that are selected and the cells that have the focus. For example, in the screenshot below, the entire `Person` table is selected, and the cell at bottom right has the focus.

| <> Name | Administration | | |
|--------------|----------------|---------|---------------------|
| ▲ Person (3) | <> First | <> Last | <> Title |
| 1 | Vernon | Callaby | |
| 2 | Frank | Further | Accounts Receivable |
| 3 | Loby | Matise | Accounting Manager |

- *Inactive Selection, Inactive Focus:* If a block of cells has been selected and one or more cells in that block has been made the focus, then both the selection and focus are active as long as Grid View is active. If, however, some other dialog or window is made active without having removed the selection or focus in Grid View, then the selection and focus in Grid View are inactive. If Grid View is made active again, then the selection and focus become active again.

Note: In addition to the colors you define here, XMLSpy uses the regular selection and menu color preferences set in the Display Settings in the Control Panel of your Windows installation.

Set Defaults

The **Set Defaults** button resets fonts to the original installation settings.

Save and exit

After making the settings, click **OK** to finish.

25.14.14.8.3 Schema Design View

The **Schema Design View** section enables you to customize the appearance of the [Schema View](#)¹⁹⁸ display of [XML Schema](#)³²⁶ and [JSON Schema](#)⁵¹² documents. Formatting will be set for the [currently active theme](#)¹⁰⁸⁰. To set the formatting of another theme, make the other theme the active theme.

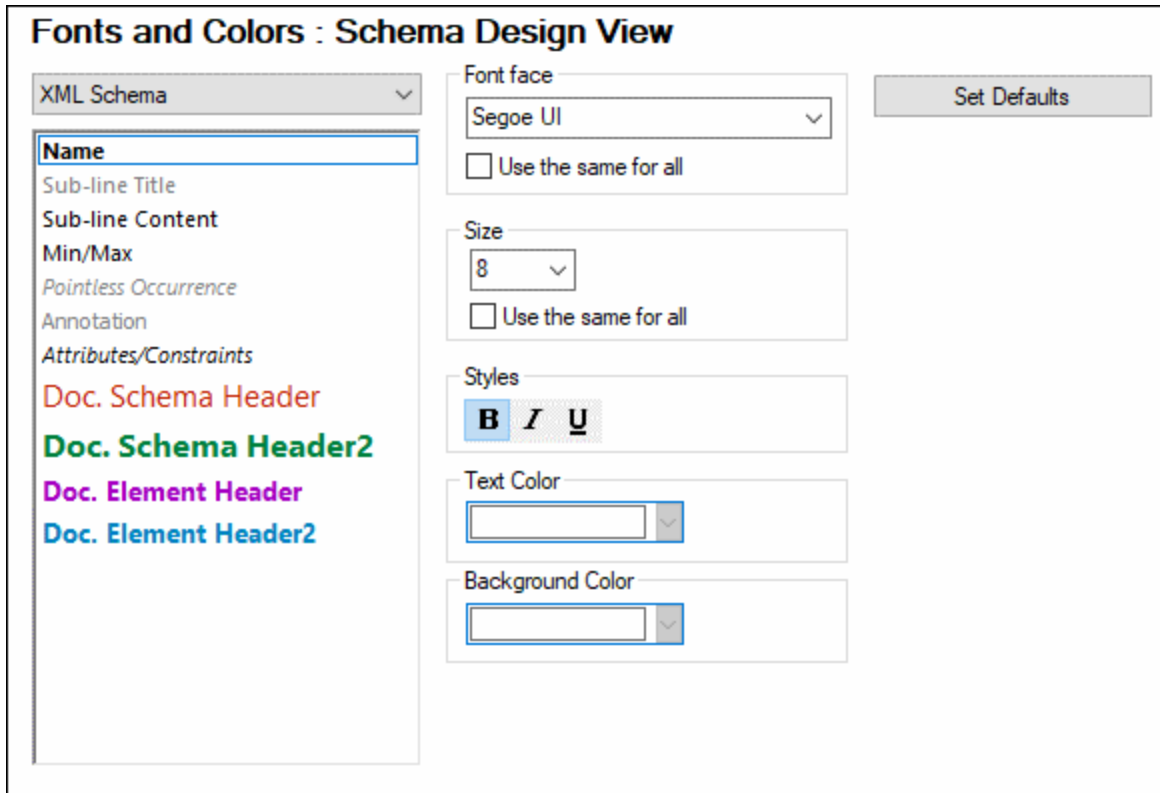

How to customize

To customize individual text item types of the selected document type, do the following:

1. In the combo box at top left, select XML Schema or JSON Schema. The text item types of the selected document type appear in the box below the combo box.
2. Select the text item type you wish to format by clicking it.
3. Set the font properties of the selected text item type by using the options in the panes on the right-hand side.

Note:

The *Doc.Schema Header(2)* and *Doc.Element Header(2)* text item types refer, respectively, to the schema header and to the element headers in the [generated documentation of the schema](#)⁸⁸⁷. Compare the colors of these properties in the dialog above with the colors of the schema header and element header of the generated documentation in the screenshot below.

Schema ExpReport.xsd

schema location: <C:\Users\am\Documents\Altova\XMLSpy2018\Examples\ExpReport.xsd>
 attributeFormDefault: **unqualified**
 elementFormDefault: **qualified**

Elements Simple types
Date [emailType](#)
[description](#)
[expense](#)
[expense-item](#)
[expense-report](#)
[Location](#)
[Meal](#)
[Parking](#)
[Travel](#)

schema location: <C:\Users\ala\Documents\Altova\XMLSpy2018\Examples\TextState.xsd>
 attributeFormDefault: **unqualified**
 elementFormDefault: **qualified**
 targetNamespace: <http://www.xmlspy.com/schemas/textstate>

Elements Complex types
bold [TextType](#)
[italic](#)
[underline](#)

element Date

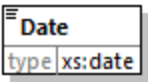
| | |
|---------|---|
| diagram |  |
| type | xs:date |

Set defaults

The **Set Defaults** button resets fonts to the original installation settings.

Save and exit

After making the settings, click **OK** to finish.

25.14.14.9 XSL

The **XSL** section (*screenshot below*) enables you to define options for XSLT transformations and XSL-FO transformations carried out from within the application. You can choose a preferred XSLT engine for transformations in XMLSpy. The relevant options for each engine are displayed in the *Engine* settings section when you select an engine. The *Output File* settings and *XSL-FO Transformation* settings that are available are the same for all engines. The screenshot below shows the settings when the built-in Altova RaptorXML XSLT engine is used.

XSL

Engine: Built-in RaptorXML XSLT engine ▼

Validate XML files used in transformation

Output file

Default file extension:

Reuse output window

Use file extension from <xsl:output method=""> attribute if provided

XSL-FO transformation

Path to engine (if using FOP, path to fop.bat):

For the XSLT part of the transformation use selected XSLT engine XSL-FO engine

Engine settings

You can set up an XSLT processor to carry out XSLT transformations when the [XSLT Transformation](#) ⁹⁰⁷ command is invoked.

You can select one of the following XSLT engine options:

- Built-in RaptorXML XSLT engine
- Microsoft XML Parser (MSXML)
- External XSLT engine

Note: For XSLT debugging in XMLSpy, the built-in RaptorXML XSLT engine is always used—even if another XSLT engine is selected here for transformations.

Altova RaptorXML XSLT Engine

XMLSpy contains the Altova RaptorXML XSLT 1.0, XSLT 2.0, and XSLT 3.0 engines, which you can use for XSLT transformations. The appropriate XSLT engine (1.0, 2.0, or 3.0) is used (according to the value of the *version* attribute of the `xsl:stylesheet` or `xsl:transform` element). This applies both for XSLT transformations as well as for XSLT debugging using XMLSpy's XSLT/XQuery Debugger.

If you wish to validate the XML files used in transformations, select the *Validate* option (see screenshot above).

Microsoft XML Parser (MSXML)

One or more of the MSXML 3.0, 4.0, or 6.0 parsers will be pre-installed on your machine. If you know which installed version you want to use, you could select it. Otherwise, you should let XMLSpy select the version automatically. (The *Choose version automatically* option is active by default.) In this case, XMLSpy tries to select the most recent available version.

External XSLT engine

Choose an external XSLT processor of your choice by entering the path to its executable file.

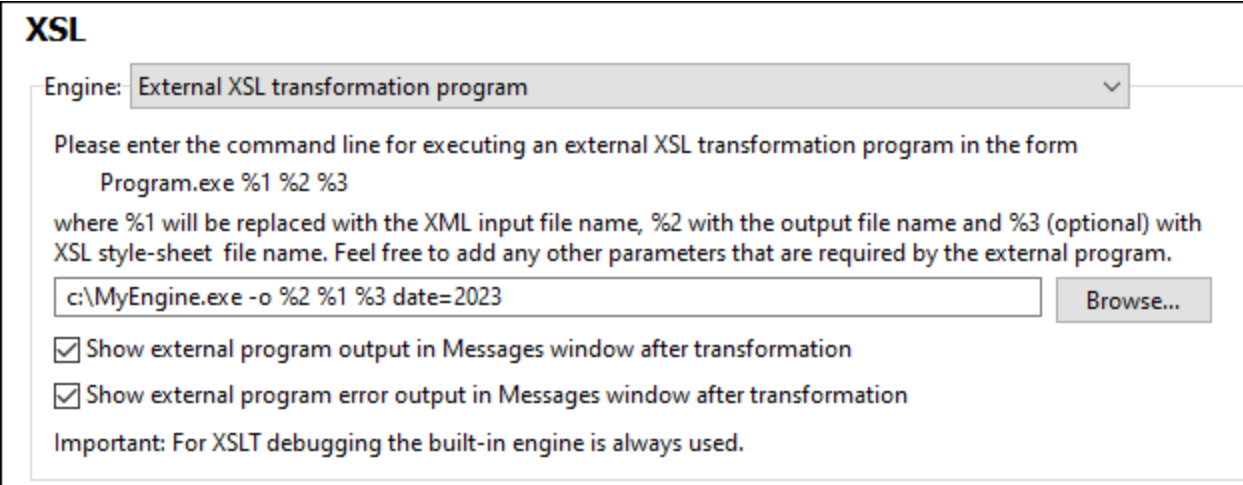

You must specify the command line string that the external XSLT processor uses to run a transformation. You can build the command line string with the following components:

- %1 = XML document to process
- %2 = Output file to generate
- %3 = XSLT stylesheet to use (if the XML document does not contain a reference to a stylesheet)

For example, say you have a processor that uses the following command pattern to run an XSLT transformation:

```
myxsltengine.exe -o <output.xml> <input.xml> <stylesheet.xslt> <param-name>=<param-value>?
```

Then, in XMLSpy, build the command line using the corresponding variables in the correct locations. For example:

```
c:\MyEngine.exe -o %2 %1 %3 date=2023
```

XMLSpy will send the correct input files to the external engine for processing and return the output file/s to an output location if one is specified and/or to an application window.

Check the respective check boxes to show the output and error messages of the external program in the Messages Window of XMLSpy.

Note: The parameters set in XMLSpy's [XSLT Input Parameters dialog](#)⁹¹⁰ are passed to the internal Altova XSLT Engines only. They are not passed to any other XSLT Engine that is set up as the default XSLT processor.

Output File settings

The following options are available:

- *Default file extension:* Sets a default file extension for output files, which can be overridden by the file extension named in the XSLT element `xs1:output` (see *last list item*).
- *Reuse output window:* Causes subsequent transformations to display the result document in the same output window. If the input XML file belongs to a project and *Reuse output window* option is disabled, the setting only takes effect if the *Save in folder* output file path (screenshot below) in the relevant [project properties](#)⁸⁴⁹ is **also** disabled.

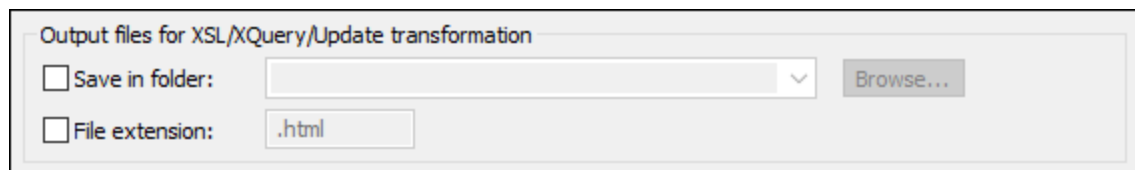

- *Use file extension of xs1:output element:* Selects whether the file extension specified in the `xs1:output` element of the XSLT stylesheet would override the default extension specified in the first option of this list.

XSL-FO Transformation settings

FO documents are processed using an FO processor, and the path to the executable of the FO processor must be specified in the text box for the XSL-FO transformation engine. The transformation is carried out using the [XSL/XQuery | XSL-FO Transformation](#)⁹⁰⁸ menu command. If the source file (the active document when the command is executed in the IDE) is an XSL-FO document, the FO processor is invoked for the transformation. If the source document is an XML document, an XSLT transformation is required to first convert the XML document to an XSL-FO document. This XSLT transformation can be carried out either by the XSLT engine you have specified as the default engine for the application (see above¹⁰⁶⁸), or by the XSLT engine that might be built into the FO processor you have specified as the default FO processor for the application. To select between these two options, click the appropriate radio button.

Note: Unless you deselected the option to install the FOP processor of the [Apache XML Project](#), it will have been installed in the folder `C:\ProgramData\Altova\SharedBetweenVersions`. If installed, the path to it will have been entered automatically in the XSL-FO Engine input box. You can set the path to any FO processor you wish to use. Note, however, that the same path will be used by other Altova products that use FO processors and have settings to select the FO processor (StyleVision and Authentic Desktop).

Save and exit

After making the settings, click **OK** to finish.

25.14.14.10 XQuery

The **XQuery** section (*screenshot below*) defines options related to the editing and execution of XQuery and XQuery Update documents.

XQuery

General Settings

Default version: 1.0 3.1

Always skip XML Source

Validate XML files used in execution

DB2 commands will retrieve maximum rows

Output

Serialization Method (XML input):

Serialization Encoding (XML input):

Serialization Method (JSON input):

Serialization Encoding (JSON input):

Omit XML Declaration

Indent Output

XQuery Update

Open files on updating Update files directly on disk

Preserve original formatting of files to the maximum extent possible
(always preserved when executed from XPath/XQuery output window)

General XQuery options

The following options are available:

- **Serialization:** Serialization refers to the way in which text is written to the output document. You can choose the serialization method (adaptive*, HTML, JSON, text, XHTML, or XML) and serialization encoding of the output for different types of input. Output serialization can be selected separately for XML input and JSON input. (*Note:* The adaptive method enables an instance document to be processed without error; it automatically determines the serialization method on the basis of the input document.)
- **Omit XML declaration:** Omits the XML declaration in the serialized (output) document.
- **Indent output:** Indents the output document to show the document hierarchy.
- **Always skip XML source:** When an XQuery document is executed, XMLSpy can prompt for an XML source on which to execute the XQuery document. The prompt is a dialog that enables you to browse for the XML file. Select this option to skip this dialog and directly execute the XQuery document. If this option is selected, then the XQuery document should be able to execute correctly without being

passed an XML document. This could be either because no XML document is required, or because XML data is accessed via functions within the XQuery document.

- *Validate XML files:* Validates XML files that are used in the execution of XQuery documents. Invalid XML files are flagged, and the XQuery document is not processed.
- *DB2 row retrieval:* In displays that show DB data, you can specify the maximum number of rows to be retrieved. XMLSpy recognizes `.xqr` [file extensions](#)¹⁰⁴³ as XQuery-for-DB files.
- *XQuery default version:* Specifies the XQuery engine version to use for execution of XQuery documents that do not have a `version` keyword. This applies to both XQuery and XQuery Update documents, and selects the default XQuery Engine to use.

XQuery Update options

The following XQuery Update options are available:

- *Updating:* When an XQuery Update file is executed, target XML files can either be updated directly on disk, or be opened in XMLSpy and updated in memory. The *Open Files on Updating* option enables you to review the updates and save the file to disk or reject the updates (by closing the file without saving).
- *Preserve original formatting:* Preserves the original formatting of the updated document as much as possible.

Save and exit

After making the settings, click **OK** to finish.

25.14.14.11 Java

In the *Java* section (see *screenshot below*), you can optionally enter the path to a Java VM (Virtual Machine) on your file system. Note that adding a custom Java VM path is not always necessary. By default, XMLSpy attempts to detect the Java VM path automatically by reading (in this order) the Windows registry and the `JAVA_HOME` environment variable. The custom path added in this dialog box will take priority over any other Java VM path detected automatically.

You may need to add a custom Java VM path, for example, if you are using a Java virtual machine which does not have an installer and does not create registry entries (e.g., Oracle's OpenJDK). You might also want to set this path if you need to override, for whatever reason, any Java VM path detected automatically by XMLSpy.

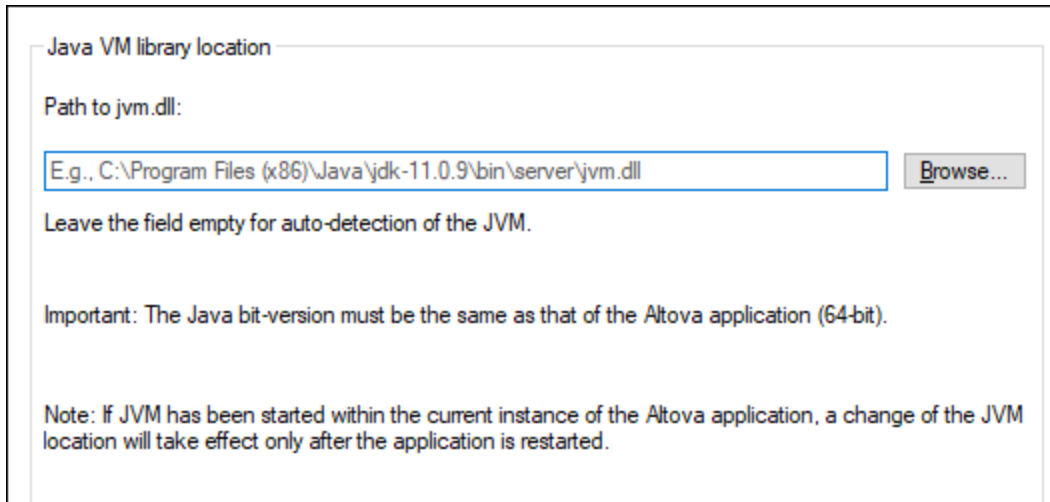

Java VM library location

Path to jvm.dll:

E.g., C:\Program Files (x86)\Java\jdk-11.0.9\bin\server\jvm.dll

Leave the field empty for auto-detection of the JVM.

Important: The Java bit-version must be the same as that of the Altova application (64-bit).

Note: If JVM has been started within the current instance of the Altova application, a change of the JVM location will take effect only after the application is restarted.

Note the following:

- The Java VM path is shared between Altova desktop (not server) applications. Consequently, if you change it in one application, it will automatically apply to all other Altova applications.
- The path must point to the `jvm.dll` file from the `\bin\server` or `\bin\client` directory, relative to the directory where the JDK was installed.
- The XMLSpy platform (32-bit, 64-bit) must be the same as that of the JDK.
- After changing the Java VM path, you may need to restart XMLSpy for the new settings to take effect.

Changing the Java VM path affects the following areas:

- JDBC connectivity
- Java extension functions for XSLT/XPath

25.14.14.12 Scripting

The **Scripting** section (*screenshot below*) allows you to enable the [Scripting Environment](#)⁹⁹⁹ on application startup. Check the *Activate Scripting* check box to do this. You can then specify the Global Scripting Project file (*see screenshot below*).

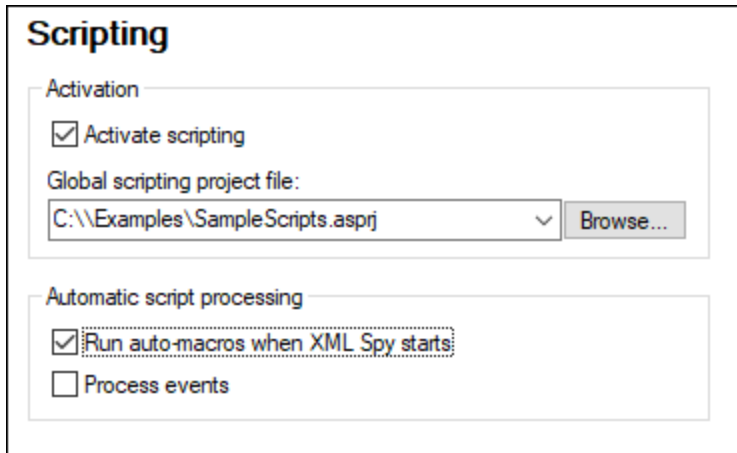

To set a global scripting project for XMLSpy, check the *Activate Scripting* check box and then browse for the Altova Scripting Project (.asprj) file you want. You can also specify: (i) whether Auto-Macros in the scripting project should be automatically executed when XMLSpy starts, and (ii) whether application event handler scripts in the project should be automatically executed or not; check or uncheck the respective check boxes accordingly.

Save and exit

After making the settings, click **OK** to finish. Macros in the Global Scripting Project will then be displayed in the submenu of the **Macros** command.

25.14.14.13 Source Control

The **Source Control** section (*screenshot below*) enables you to specify the source control provider, and the settings and default logon ID for each source control provider.

Source Control

Current source control plug-in:
Microsoft Visual SourceSafe

Logon ID (SourceSafe):
MYFAVID

Perform background status updates every 500 ms
 Display output messages from plug-in
 Get everything when opening a project
 Check in everything when closing a project
 Don't show Check Out dialog box when checking out items
 Don't show Check In dialog box when checking in items
 Keep items checked out when checking in or adding items

If dialogs were hidden using Don't show this again, click Reset to view them again.

Source Control Plugin

The current source control plugin can be selected from among the currently installed source control systems. These systems are listed in the dropdown list of the combo box. After selecting the required source control, specify the login ID for it in the next text box. The **Advanced** button pops up a dialog specific to the selected source control plugin, in which you can define settings for that source control plugin. These settings are different for different source control plugins.

User preferences

A range of user preferences is available, including the following:

- Status updates can be performed in the background after a user-defined interval of time, or they can be switched off entirely. Very large source control databases could consume considerable CPU and network resources. The system can be speeded up, however, by disabling background status updates or increasing the interval between them..
- When opening and closing projects, files can be automatically checked out and checked in, respectively.
- The display of the Check Out and Check In dialogs can be suppressed.
- The **Reset** button is enabled if you have checked/activated the *Don't show this again* option in one of the dialog boxes. On clicking the **Reset** button, the *Don't show this again* prompt is re-enabled.

Save and exit

After making the settings, click **OK** to finish.

25.14.14.14 Network

The **Network** section (*screenshot below*) enables you to configure important network settings.

Network

IP Addresses

Use IPv6 addresses

Timeout

Transfer timeout: 40 s

Connect phase timeout: 300 s

Certificate

Verify TLS/SSL server certificate

Verify TLS/SSL server identity

IP addresses

When host names resolve to more than one address in mixed IPv4/IPv6 networks, selecting this option causes the IPv6 addresses to be used. If the option is not selected in such environments and IPv4 addresses are available, then IPv4 addresses are used.

Timeout

- *Transfer timeout*: If this limit is reached for the transfer of any two consecutive data packages of a transfer (sent or received), then the entire transfer is aborted. Values can be specified in seconds [s] or milliseconds [ms], with the default being 40 seconds. If the option is not selected, then there is no time limit for aborting a transfer.
- *Connection phase timeout*: This is the time limit within which the connection has to be established, including the time taken for security handshakes. Values can be specified in seconds [s] or milliseconds [ms], with the default being 300 seconds. This timeout cannot be disabled.

Certificate

- *Verify TLS/SSL server certificate*: If selected, then the authenticity of the server's certificate is checked by verifying the chain of digital signatures until a trusted root certificate is reached. This option is enabled by default. If this option is not selected, then the communication is insecure, and attacks (for example, a man-in-the-middle attack) would not be detected. Note that this option does not verify that the certificate is actually for the server that is communicated with. To enable full security, both the certificate and the identity must be checked (*see next option*).
- *Verify TLS/SSL server identity*: If selected, then the server's certificate is verified to belong to the server we intend to communicate with. This is done by checking that the server name in the URL is the same as the name in the certificate. This option is enabled by default. If this option is not selected, then the server's identity is not checked. Note that this option does not enable verification of the server's certificate. To enable full security, both the certificate as well as the identity must be checked (*see*

previous option).

Save and exit

After making the settings, click **OK** to finish.

25.14.14.15 Network Proxy

The *Network Proxy* section enables you to configure custom proxy settings. These settings affect how the application connects to the Internet (for XML validation purposes, for example). By default, the application uses the system's proxy settings, so you should not need to change the proxy settings in most cases. If necessary, however, you can set an alternative network proxy by selecting, in the *Proxy Configuration* combo box, either *Automatic* or *Manual* to configure the settings accordingly.

Note: The network proxy settings are shared among all Altova MissionKit applications. So, if you change the settings in one application, all MissionKit applications will be affected.

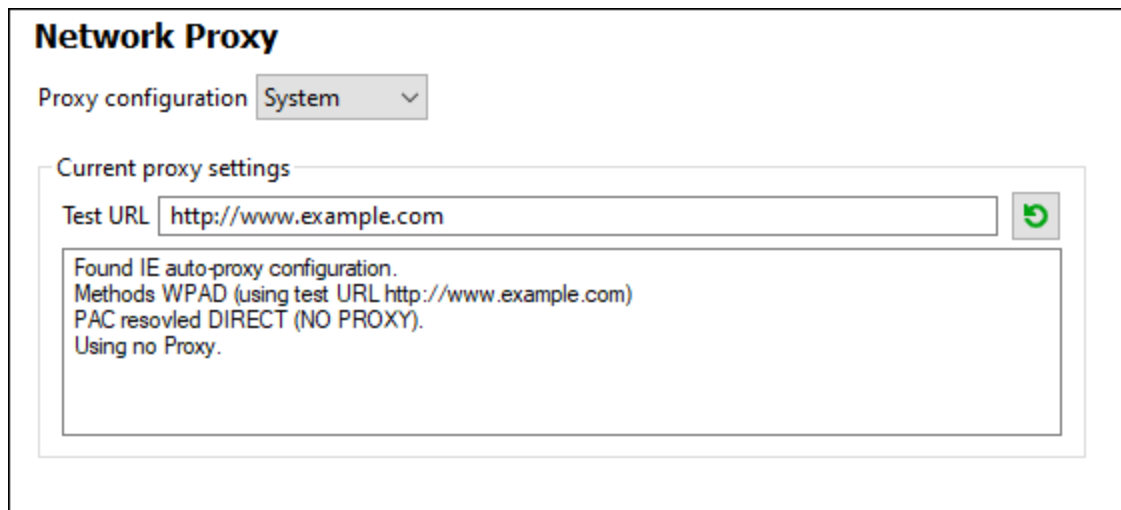

Use system proxy settings

Uses the Internet Explorer (IE) settings configurable via the system proxy settings. It also queries the settings configured with `netsh.exe winhttp`.

Automatic proxy configuration

The following options are provided:

- *Auto-detect settings*: Looks up a WPAD script (`http://wpad.LOCALDOMAIN/wpad.dat`) via DHCP or DNS, and uses this script for proxy setup.
- *Script URL*: Specify an HTTP URL to a proxy-auto-configuration (`.pac`) script that is to be used for proxy setup.
- *Reload*: Resets and reloads the current auto-proxy-configuration. This action requires Windows 8 or newer, and may need up to 30s to take effect.

Manual proxy configuration

Manually specify the fully qualified host name and port for the proxies of the respective protocols. A supported

scheme may be included in the host name (for example: `http://hostname`). It is not required that the scheme is the same as the respective protocol if the proxy supports the scheme.

Network Proxy

Proxy configuration Manual ▼

HTTP Proxy Port

Use this proxy server for all protocols

SSL Proxy Port

No Proxy for

Do not use the proxy server for local addresses

Current proxy settings

Test URL ↻

(using test URL `http://www.example.com`)
Using no Proxy.

The following options are provided:

- *HTTP Proxy*: Uses the specified host name and port for the HTTP protocol. If *Use this proxy server for all protocols* is selected, then the specified HTTP proxy is used for all protocols.
- *SSL Proxy*: Uses the specified host name and port for the SSL protocol.
- *No Proxy for*: A semi-colon (;) separated list of fully qualified host names, domain names, or IP addresses for hosts that should be used without a proxy. IP addresses may not be truncated and IPv6 addresses have to be enclosed by square brackets (for example: `[2606:2800:220:1:248:1893:25c8:1946]`). Domain names must start with a leading dot (for example: `.example.com`).
- *Do not use the proxy server for local addresses*: If checked, adds `<1oca1>` to the *No Proxy for* list. If this option is selected, then the following will not use the proxy: (i) `127.0.0.1`, (ii) `:::1`, (iii) all host names not containing a dot character (.).

Current proxy settings

Provides a verbose log of the proxy detection. It can be refreshed with the **Refresh** button to the right of the *Test URL* field (for example, when changing the test URL, or when the proxy settings have been changed).

- *Test URL*: A test URL can be used to see which proxy is used for that specific URL. No I/O is done with this URL. This field must not be empty if proxy-auto-configuration is used (either through *Use system proxy settings* or *Automatic proxy configuration*).

25.14.14.16 AI-Assistant

Enter your OpenAI API key in the AI-Assistant options section. This enables you to use XMLSpy's AI-Assistant (accessible via the Window menu) directly—that is, without having to enter your OpenAI API key each time you open the assistant or make an OpenAI request.

In order to create an OpenAI API key, you will need to first open an OpenAI account and then generate the key. Instructions for how to do this are given in the Options dialog.

25.14.14.17 Help

XMLSpy provides Help (the user manual) in two formats:

- Online Help, in HTML format, which is available at the Altova website. In order to access the Online Help you will need Internet access.
- A Help file in PDF format, which is installed on your machine when you install XMLSpy. It is named `XMLSpy.pdf` and is located in the application folder (in the Program Files folder). If you do not have Internet access, you can always open this locally saved Help file.

The Help option (*screenshot below*) enables you to select which of the two formats is opened when you click the **Help (F1)** command in the **Help** menu.

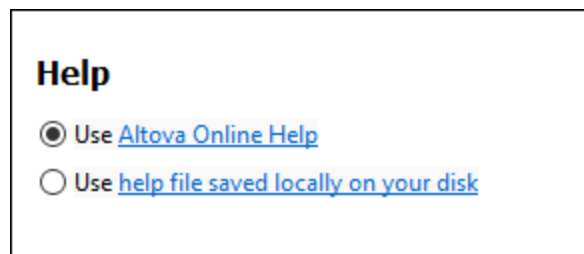

You can change this option at any time for the new selection to take effect. The links in this section (see *screenshot above*) open the respective Help format.

25.15 Window Menu

The **Window** menu contains commands that let you organize individual application and document windows within the GUI. You can cascade or tile open document windows, and you can arrange entry helper and output windows as well as hide them.

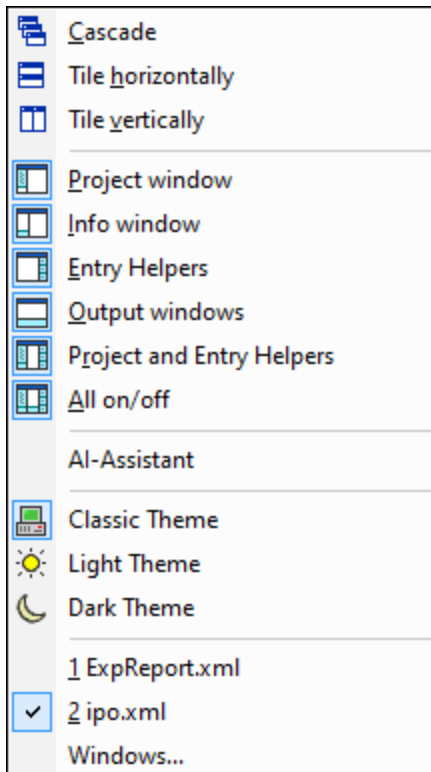

Cascade, Tile Horizontally/Vertically

The **Cascade** command arranges document windows so that they are staggered in a sequence from back to forward.

The **Tile Horizontally** and **Tile Vertically** arranges the windows of open and non-minimized documents so that they are re-sized as tiles that are all visible within the application window.

Project Window, Info Window, Entry Helpers, Output Windows

These commands switch the display of, respectively, the [Project Window](#)¹¹⁰, [Info Window](#)¹¹², [Entry Helpers](#)¹¹², and [Output Windows](#)¹¹³ on or off.

Each of these windows is a dockable window. Dragging on the window's title bar detaches it from its current position and makes it a floating window. Click right on the title bar, to allow docking or hide the window.

AI-Assistant

The **AI-Assistant** command opens the AI-Assistant dialog, in which you can ask for assistance from ChatGPT

for your work in XMLSpy. Note that, in order to use the AI-Assistant, you must create an OpenAI account, generate an OpenAI API key, and register the key in XMLSpy in the AI-Assistant section of XMLSpy's Options dialog.

The AI-Assistant works as follows:

- Type your request in the input field at the bottom of the dialog and click **Send**. (Alternatively, you can select a sample request in the combo box. This request will be entered in the input field, where you can modify it before sending.)
- The response from ChatGPT will be displayed in the dialog's main pane.
- You can send additional requests, and these, followed by the respective responses from ChatGPT, will be appended to the chat history in the main pane.
- You can start an additional chat by clicking the **+** icon to the right of the chat tab/s at the top of the main pane. The new chat will be opened in its own tab.
- You can copy a response (by clicking it in its tab) or a part of a response (by selecting the part you want) either to the clipboard or to a new file. Click the respective command icon (Copy to clipboard or Create new file) in the toolbar of the dialog. You can also use regular Windows command shortcuts, such as **Ctrl+C** to copy to clipboard. You can also copy a selection to the XPath/XQuery Window by clicking the corresponding toolbar command icon.
- To close a chat, click the **X** icon in the chat's tab header.

Project and Entry Helpers

This command toggles on and off the display of the [Project Window](#)¹¹⁰ and the [Entry Helpers](#)¹¹² together. It saves you the trouble of switching on/off the display of these windows individually.

All On/Off

This command lets you switch all dockable windows (*listed below*) on or off.

- [Project Window](#)¹¹⁰
- [Info Window](#)¹¹²
- [Entry Helpers](#)¹¹²
- [Output Windows](#)¹¹³

This is useful if you want to hide all non-document windows quickly, to get the maximum viewing area for the document/s you are working on.

Themes

XMLSpy offers you a choice of the three themes listed below. When you select a theme, it is applied immediately.

- Classic (the default)
- Light
- Dark

For the currently active theme, you can customize the formatting of a document type's individual text components. Do this in the [Fonts and Colors](#)¹⁰⁶⁶ tabs of the Options dialog ([Tools | Options](#)¹⁰⁴⁰).

Currently open window list

This list shows all currently open windows, and lets you quickly switch between them.

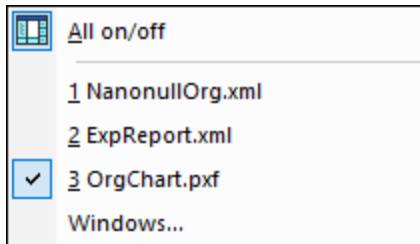

You can also use **CTRL+F6** keyboard shortcuts to cycle through the open windows.

25.16 Help Menu

The **Help** menu contains commands required to get help or more information about XMLSpy, as well as links to information and support pages on the Altova web server.

The **Help** menu also contains the [Registration dialog](#)¹⁰⁸⁴, which lets you enter your license key-code once you have purchased the product.

25.16.1 Help

The **Help (F1)** command opens the application's Help documentation (its user manual). By default, the Online Help in HTML format at the Altova website will be opened.

If you do not have Internet access or do not want, for some other reason, to access the Online Help, you can use the locally stored version of the user manual. The local version is a PDF file named `XMLSpy.pdf` that is stored in the application folder (in the Program Files folder).

If you want to change the default format to open (Online Help or local PDF), do this in the Help section of the Options dialog (menu command **Tools | Options**).

25.16.2 Keyboard Map

The **Help | Keyboard Map** command causes an information box to be displayed that contains a menu-by-menu listing of all commands in XMLSpy. Menu commands are listed with a description and shortcut keystrokes for the command.

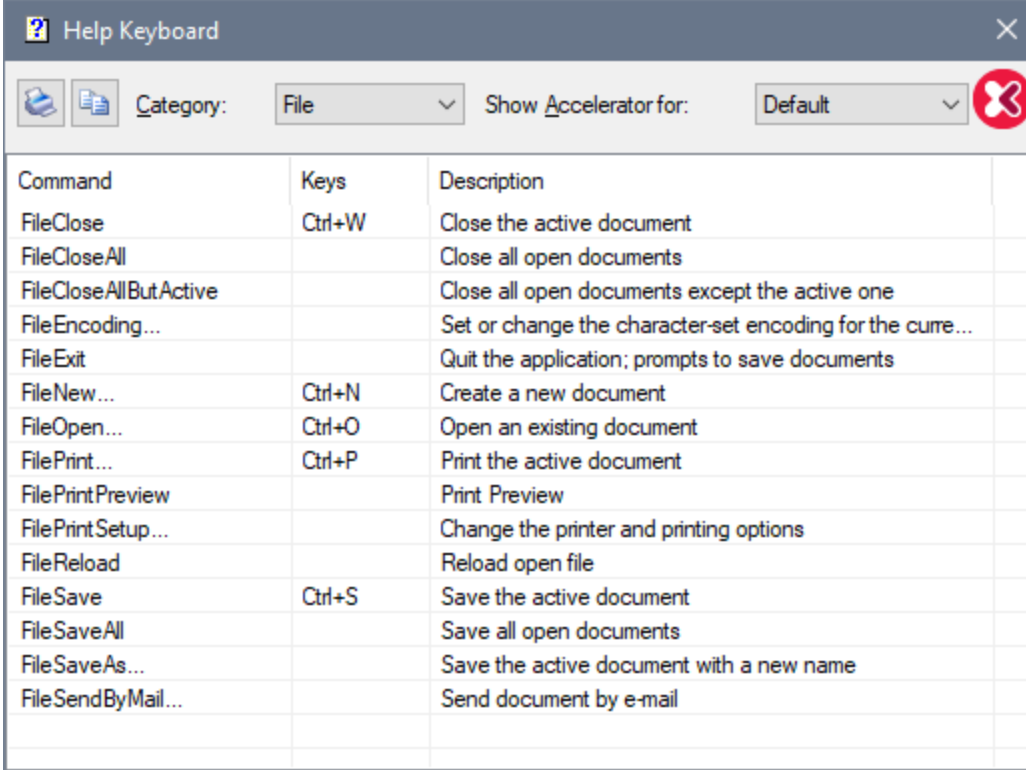

| Command | Keys | Description |
|-----------------------|--------|---|
| FileClose | Ctrl+W | Close the active document |
| FileCloseAll | | Close all open documents |
| FileCloseAllButActive | | Close all open documents except the active one |
| FileEncoding... | | Set or change the character-set encoding for the curre... |
| FileExit | | Quit the application; prompts to save documents |
| FileNew... | Ctrl+N | Create a new document |
| FileOpen... | Ctrl+O | Open an existing document |
| FilePrint... | Ctrl+P | Print the active document |
| FilePrintPreview | | Print Preview |
| FilePrintSetup... | | Change the printer and printing options |
| FileReload | | Reload open file |
| FileSave | Ctrl+S | Save the active document |
| FileSaveAll | | Save all open documents |
| FileSaveAs... | | Save the active document with a new name |
| FileSendByMail... | | Send document by e-mail |

To view commands in a particular menu, select the menu name in the Category combo box. You can print the command by clicking the printer icon.

You should note the following points about shortcuts:

- Certain commands (and their shortcuts) are applicable only within a certain view. For example, most of the commands in the XML menu are applicable only in Grid View. Other commands (such as **File | Save** or **XML | Check Well-Formedness**) are available in multiple views.
- Other cool shortcuts: For example, **Shift+F10** brings up the context menu in Text View and Schema View; **Ctrl+E** when the cursor is inside an element start or end tag in Text View moves the cursor to the end or start tag, respectively.
- In the [Keyboard tab](#) ⁽¹⁰²⁷⁾ of the Customize dialog, you can also set your own shortcuts for various menu commands.

25.16.3 Activation, Order Form, Registration, Updates

☐ Software Activation

License your product

After you download your Altova product software, you can license—or activate—it using either a free evaluation key or a purchased permanent license key.

- **Free evaluation license.** When you first start the software after downloading and installing it, the **Software Activation** dialog will pop up. In it is a button to request a free evaluation license. Click

it to get your license. When you click this button, your machine-ID will be hashed and sent to Altova via HTTPS. The license information will be sent back to the machine via an HTTP response. If the license is created successfully, a dialog to this effect will appear in your Altova application. On clicking **OK** in this dialog, the software will be activated for a period of 30 days **on this particular machine**.

- **Permanent license key.** The **Software Activation** dialog allows you to purchase a permanent license key. Clicking this button takes you to Altova's online shop, where you can purchase a permanent license key for your product. Your license will be sent to you by e-mail in the form of a license file, which contains your license-data.

There are three types of permanent license: *installed*, *concurrent user*, and *named user*. An installed license unlocks the software on a single computer. If you buy an installed license for N computers, then the license allows use of the software on up to N computers. A concurrent-user license for N concurrent users allows N users to run the software concurrently. (The software may be installed on $10N$ computers.) A named-user license authorizes a specific user to use the software on up to 5 different computers. To activate your software, click **Upload a New License**, and, in the dialog that appears, enter the path to the license file, and click **OK**.

Note: For multi-user licenses, each user will be prompted to enter his or her own name.

Your license email and the different ways to license (activate) your Altova product

The license email that you receive from Altova will contain your license file as an attachment. The license file has a `.altova_licenses` file extension.

To activate your Altova product, you can do one of the following:

- Save the license file (`.altova_licenses`) to a suitable location, double-click the license file, enter any requested details in the dialog that appears, and finish by clicking **Apply Keys**.
- Save the license file (`.altova_licenses`) to a suitable location. In your Altova product, select the menu command **Help | Software Activation**, and then **Upload a New License**. Browse for or enter the path to the license file, and click **OK**.
- Save the license file (`.altova_licenses`) to any suitable location, and upload it from this location to the license pool of your [Altova LicenseServer](#). You can then either: (i) acquire the license from your Altova product via the product's Software Activation dialog (see below) or (ii) assign the license to the product from Altova LicenseServer. *For more information about licensing via LicenseServer, read the rest of this topic.*

You can access the **Software Activation** dialog (screenshot below) at any time by clicking the **Help | Software Activation** command.

Activate your software

You can activate the software by registering the license in the Software Activation dialog or by licensing via [Altova LicenseServer](#) (see details below).

- *Registering the license in the Software Activation dialog.* In the dialog, click **Upload a New License** and browse for the license file. Click **OK** to confirm the path to the license file and to confirm any data you entered (your name in the case of multi-user licenses). Finish by clicking

Save.

- Licensing via Altova LicenseServer on your network:* To acquire a license via an Altova LicenseServer on your network, click **Use Altova LicenseServer**, located at the bottom of the **Software Activation** dialog. Select the machine on which the LicenseServer you want to use has been installed. Note that the auto-discovery of License Servers works by means of a broadcast sent out on the LAN. As these broadcasts are limited to a subnet, License Server must be on the same subnet as the client machine for auto-discovery to work. If auto-discovery does not work, then type in the name of the server. The Altova LicenseServer must have a license for your Altova product in its license pool. If a license is available in the LicenseServer pool, this is indicated in the **Software Activation** dialog (see *screenshot below showing the dialog in Altova XMLSpy*). Click **Save** to acquire the license.

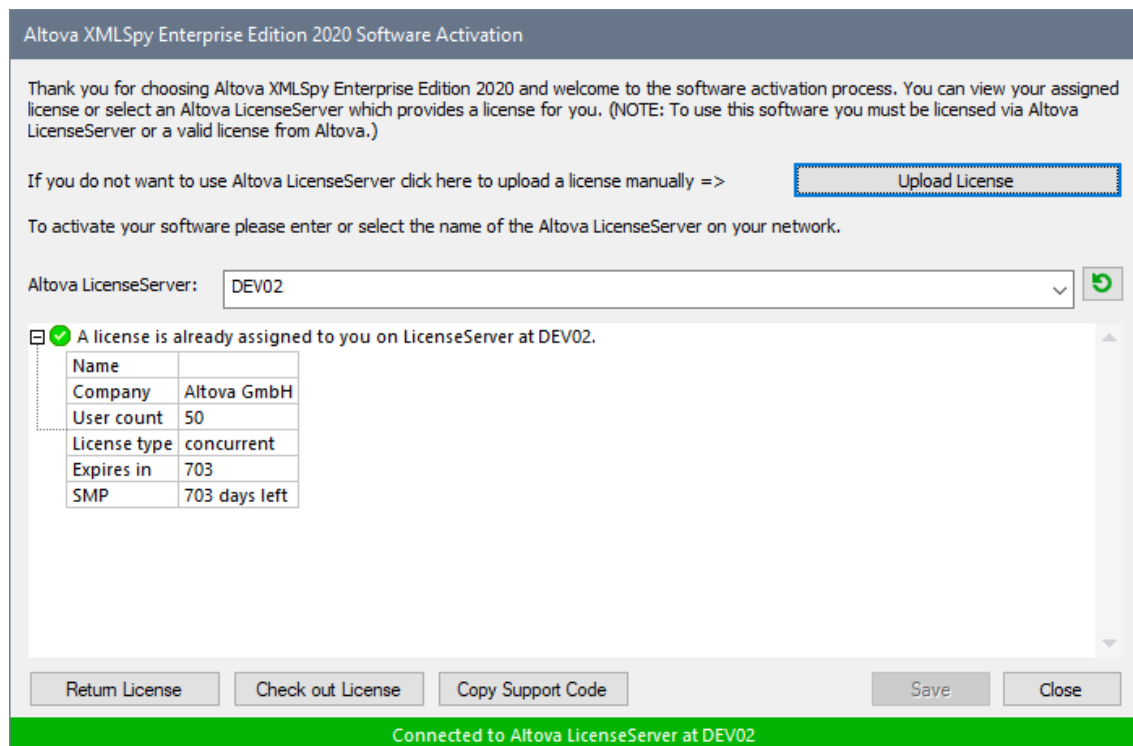

After a machine-specific (aka installed) license has been acquired from LicenseServer, it cannot be returned to LicenseServer for a period of seven days. After that time, you can return the machine license to LicenseServer (click **Return License**) so that this license can be acquired from LicenseServer by another client. (A LicenseServer administrator, however, can unassign an acquired license at any time via the administrator's Web UI of LicenseServer.) Note that the returning of licenses applies only to machine-specific licenses, not to concurrent licenses.

Check out license

You can check out a license from the license pool for a period of up to 30 days so that the license is stored on the product machine. This enables you to work offline, which is useful, for example, if you wish to work in an environment where there is no access to your Altova LicenseServer (such as when your Altova product is installed on a laptop and you are traveling). While the license is checked out, LicenseServer displays the license as being in use, and the license cannot be used by any other machine. The license automatically reverts to the checked-in state when the check-out period ends. Alternatively, a checked-out license can be checked in at any time via the **Check**

in button of the **Software Activation** dialog.

To check out a license, do the following: (i) In the **Software Activation** dialog, click **Check out License** (see *screenshot above*); (ii) In the **License Check-out** dialog that appears, select the check-out period you want and click **Check out**. The license will be checked out. After checking out a license, two things happen: (i) The **Software Activation** dialog will display the check-out information, including the time when the check-out period ends; (ii) The **Check out License** button in the dialog changes to a **Check In** button. You can check the license in again at any time by clicking **Check In**. Because the license automatically reverts to the checked-in status after the check-out period elapses, make sure that the check-out period you select adequately covers the period during which you will be working offline.

If the license being checked out is a Installed User license or Concurrent User license, then the license is checked out to the machine and is available to the user who checked out the license. If the license being checked out is a Named User license, then the license is checked out to the Windows account of the named user. License check-out will work for virtual machines, but not for virtual desktop (in a VDI). Note that, when a Named User license is checked out, the data to identify that license check-out is stored in the user's profile. For license check-out to work, the user's profile must be stored on the local machine that will be used for offline work. If the user's profile is stored at a non-local location (such as a file-share), then the checkout will be reported as invalid when the user tries to start the Altova application.

License check-ins must be to the same major version of the Altova product from which the license was checked out. So make sure to check in a license before you upgrade your Altova product to the next major version.

Note: For license check-outs to be possible, the check-out functionality must be enabled on LicenseServer. If this functionality has not been enabled, you will get an error message to this effect when you try to check out. In this event, contact your LicenseServer administrator.

Copy Support Code

Click **Copy Support Code** to copy license details to the clipboard. This is the data that you will need to provide when requesting support via the [online support form](#).

Altova LicenseServer provides IT administrators with a real-time overview of all Altova licenses on a network, together with the details of each license as well as client assignments and client usage of licenses. The advantage of using LicenseServer therefore lies in administrative features it offers for large-volume Altova license management. Altova LicenseServer is available free of cost from the [Altova website](#). For more information about Altova LicenseServer and licensing via Altova LicenseServer, see the [Altova LicenseServer documentation](#).

☐ Order Form

When you are ready to order a licensed version of the software product, you can use either the **Purchase a Permanent License Key** button in the **Software Activation** dialog (see *previous section*) or the **Order Form** command to proceed to the secure Altova Online Shop.

☐ Registration

Opens the Altova Product Registration page in a tab of your browser. Registering your Altova software will help ensure that you are always kept up to date with the latest product information.

☐ Check for Updates

Checks with the Altova server whether a newer version than yours is currently available and displays a message accordingly.

25.16.4 Other Commands

Support Center

A link to the Altova Support Center on the Internet. The Support Center provides FAQs, discussion forums where problems are discussed, and access to Altova's technical support staff.

Download Components and Free Tools

A link to Altova's Component Download Center on the Internet. From here you can download a variety of companion software to use with Altova products. Such software ranges from XSLT and XSL-FO processors to Application Server Platforms. The software available at the Component Download Center is typically free of charge.

XMLSpy on the Internet

A link to the [Altova website](#) on the Internet. You can learn more about XMLSpy, related technologies and products on the [Altova website](#).

XMLSpy Training

A link to the Online Training page on the [Altova website](#). Here you can select from online courses conducted by Altova's expert trainers.

About XMLSpy

Displays the splash window and version number of your product. If you are using the 64-bit version of XMLSpy, this is indicated with the suffix (x64) after the application name. There is no suffix for the 32-bit version.

25.17 Command Line

Certain XMLSpy actions can be carried out from the command line. These commands are listed below:

Open a file

```
xmlspy.exe file.xml
```

Opens the file, `file.xml`, in XMLSpy

Open multiple files

```
xmlspy.exe file1.xml file2.xml
```

Opens the files, `file1.xml` and `file2.xml`, in XMLSpy

Assign an SPS file to an XML file for Authentic View editing

```
xmlspy.exe myxml.xml /sps myspys.sps
```

Opens the file, `myxml.xml` in Authentic View with `myspys.sps` as its SPS file. The `/sps` flag specifies that the SPS file that follows is to be used with the XML file that precedes the `/sps` flag (for Authentic View editing).

Open a new XML template file via an SPS file

```
xmlspy.exe myspys.sps
```

Opens a new XML file in Authentic View. The display will be based on the SPS and the new XML file will have a skeletal structure based on the SPS schema. The name of the newly created XML file must be assigned when saving the XML file.

Open an SPS file as an XML document in Text View

```
xmlspy.exe /raw myspys.sps
```

Opens the file `myspys.sps` as an XML document in Text View. The `/raw` flag specifies that the SPS file that follows is to be edited as an XML file.

26 Programmers' Reference

XMLSpy is an Automation Server: It exposes programmable objects to other applications called Automation Clients. An Automation Client can directly access the objects and functionality that the Automation Server makes available. So, an Automation Client of XMLSpy can use, for example, the XML validation functionality of XMLSpy. As a consequence, developers can enhance their applications with the ready-made functionality of XMLSpy.

The programmable objects of XMLSpy are made available to Automation Clients via the Application API of XMLSpy, which is a COM API. The Application API of XMLSpy will also be called Application API for short from now onwards. The object model of the Application API and a complete description of all the available objects are provided in this documentation (see the section [Application API](#)¹¹³⁴).

Execution environments

The Application API can be accessed from within the following environments:

- [Scripting Editor](#)¹⁰⁹²
- [IDE Plug-ins](#)¹¹¹⁹
- [External programs](#)¹¹³⁴
- [ActiveX Integration](#)¹⁴⁸⁰

Each of these environments is described briefly below.

Scripting Editor: Customizing and modifying XMLSpy functionality

You can customize your installation of XMLSpy by modifying and adding functionality to it. You can also create Forms for user input and modify the user interface so that it contains new menu commands and toolbar shortcuts. All these features are achieved by writing scripts that interact with objects of the Application API. To aid you in carrying out these tasks efficiently, XMLSpy offers you an in-built Scripting Editor. A complete description of the functionality available in the Scripting Editor and how it is to be used is given in the [Scripting Editor](#)¹⁰⁹² section of this documentation. The supported programming languages are **JScript** and **VBScript**.

IDE Plug-ins: Creating plug-ins for XMLSpy

XMLSpy enables you to create your own plug-ins and integrate them into XMLSpy. You can do this using XMLSpy's special interface for plug-ins. A description of how to create plug-ins is given in the section [XMLSpy IDE Plug-ins](#)¹¹¹⁹. An application object gets passed to most methods that must be implemented by an IDE plug-in and gets called by the application. Typical languages used to implement an IDE plug-in are **C#** and **C++**. For more information, see the section [XMLSpy IDE Plug-ins](#)¹¹¹⁹.

External programs

Additionally, you can manipulate XMLSpy with external scripts. For example, you could write a script to open XMLSpy at a given time, then open an XML file in XMLSpy, validate the file, and print it out. External scripts would again make use of the Application API to carry out these tasks. For a description of the Application API, see the section [Application API](#)¹¹³⁴.

Using the Application API from outside XMLSpy requires an instance of XMLSpy to be started first. How this is done depends on the programming language used. See the section, [Programming Languages](#)¹¹³⁶, for information about individual languages.

Essentially, XMLSpy will be started via its COM registration. Then the `Application` object associated with the XMLSpy instance is returned. Depending on the COM settings, an object associated with an already running XMLSpy can be returned. Any programming language that supports creation and invocation of COM objects can be used. The most common of these are listed below.

- [JScript](#)¹¹⁵⁹ and [VBScript](#)¹¹⁴⁶ script files have a simple syntax and are designed to access COM objects. They can be run directly from a DOS command line or with a double click on Windows Explorer. They are best used for simple automation tasks.
- [C#](#)¹¹⁴⁹ is a full-fledged programming language that has a wide range of existing functionality. Access to COM objects can be automatically wrapped using C#.
- C++ provides direct control over COM access but requires relatively larger amounts of code than the other languages.
- [Java](#)¹¹⁵⁹: Altova products come with native Java classes that wrap the Application API and provide a full Java look-and-feel.
- Other programming languages that make useful alternatives are: Visual Basic for Applications, Perl, and Python.

ActiveX Integration

A special case of accessing the Application API is via the XMLSpy ActiveX control. This feature is only available if the [XMLSpy integration package](#)¹⁴⁸⁰ is installed. Every ActiveX Control has a property that returns a corresponding COM object for its underlying functionality. The manager control provides an `Application` object, the document control a `Document` object, and the placeholder object, in cases where it contains the project tree, returns the `Project` object. The methods supported by these objects are exactly as described in the [Interfaces section of the Application API](#)¹¹⁷¹. Care must be taken not to use methods that do not make sense in the context of ActiveX control integration. For details see [ActiveX Integration](#)¹⁴⁸⁰.

About Programmers' Reference

The documentation contained in the Programmers' Reference for XMLSpy consists of the following sections:

- [Scripting Editor](#)¹⁰⁹²: a user reference for the Scripting Environment available in XMLSpy
- [IDE Plug-ins](#)¹¹¹⁹: a description of how to create plug-ins for XMLSpy
- [Application API](#)¹¹³⁴: a reference for the Application API
- [ActiveX Integration](#)¹⁴⁸⁰: a guide and reference for how to integrate the XMLSpy GUI and XMLSpy functionality using an ActiveX control

26.1 Scripting Editor

Scripting Editor is a development environment built into XMLSpy from where you can customize the functionality of XMLSpy with the help of JScript or VBScript scripts. For example, you can add a new menu item to perform a custom project task, or you can have XMLSpy trigger some behavior each time when a document is opened or closed. To make this possible, you create scripting projects—files with .asprj extension (Altova Scripting Project).

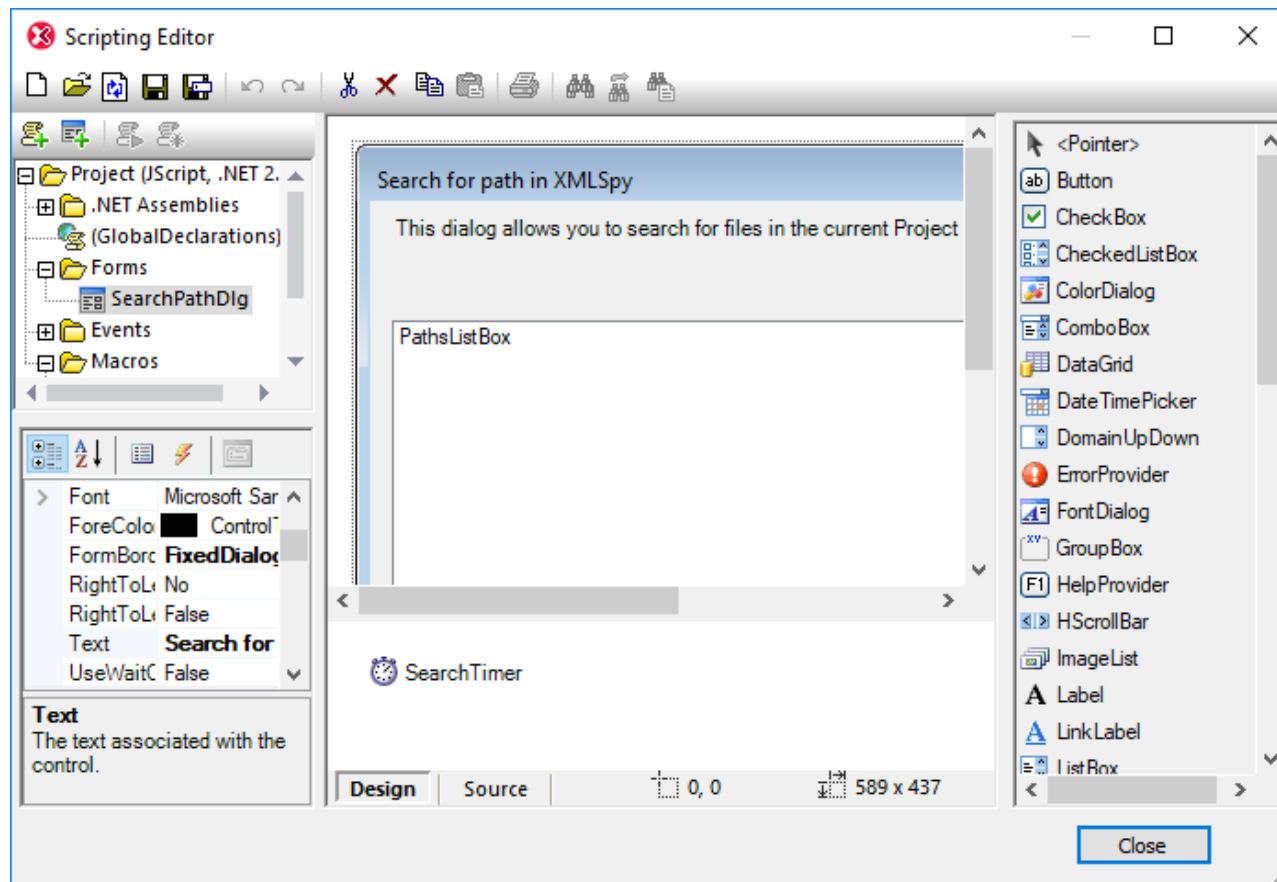

Scripting Editor

Scripting projects typically include one or several macros—these are programs that perform miscellaneous custom tasks when invoked. You can run macros either explicitly from a menu item (or a toolbar button, if configured), or you can set up a macro to run automatically whenever XMLSpy starts. The scripting environment also integrates with the XMLSpy COM API. For example, your VBScript or JScript scripts can handle application or document events such as starting or shutting down XMLSpy, opening or closing a project, and so on. Scripting projects can include Windows Forms that you can design visually, in a way similar to Visual Studio. In addition, several built-in commands are available that help you instantiate and use .NET classes from VBScript or JScript code.

Once your scripting project is complete, you can enable it either globally in XMLSpy, or only for specific projects.

Scripting Editor requires .NET Framework 2.0 or later to be installed before XMLSpy is installed.

26.1.1 Creating a Scripting Project

All scripts and scripting information created in the Scripting Editor are stored in Altova Scripting Projects (.asprj files). A scripting project may contain macros, application event handlers, and forms (which can have their own event handlers). In addition, you can add global variables and functions to a "Global Declarations" script—this makes such variables and functions accessible across the entire project.

To start a new project, run the menu command **Tools | Scripting Editor**.

The languages supported for use in a scripting project are JScript and VBScript (not to be confused with Visual Basic, which is not supported). These scripting engines are available by default on Windows and have no special requirements to run. You can select a scripting language as follows:

1. Right-click the **Project** item in the upper-left pane, and select **Project settings** from the context menu.
2. Select a language (JScript or VBScript), and click **OK**.

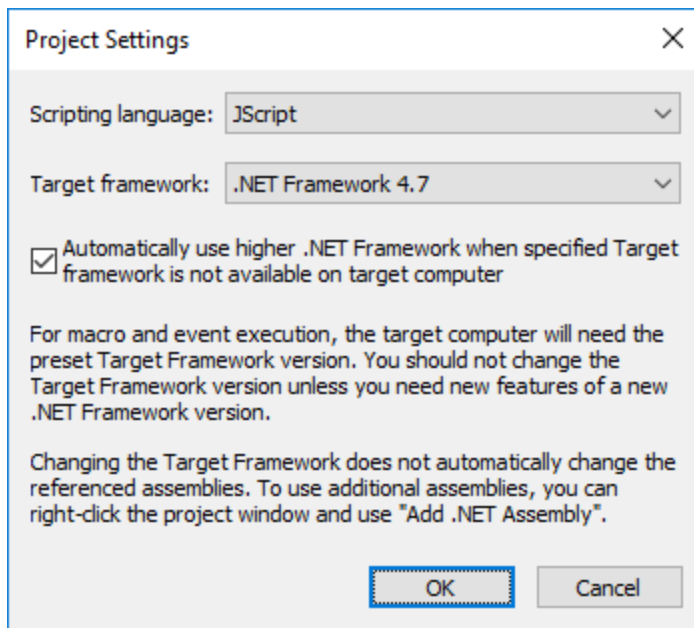

From the Project settings dialog box above, you can also change the target .NET Framework version. This is typically necessary if your scripting project requires features available in a newer .NET Framework version. Note that any clients using your scripting project will need to have the same .NET Framework version installed (or a later compatible version).

By default, a scripting project references several .NET assemblies, like `System`, `System.Data`, `System.Windows.Forms`, and others. If necessary, you can import additional .NET assemblies, including assemblies from .NET Global Assembly Cache (GAC) or custom .dll files. You can import assemblies as follows:

1. Statically, by adding them manually to the project. Right-click **Project** in the top-left pane, and select **Add .NET Assembly** from the context menu.

2. Dynamically, at runtime, by calling the `CLR.LoadAssembly`¹¹⁰⁹ command from the code.

You can create multiple scripting projects if necessary. You can save a scripting project to the disk, and then load it back into the Scripting Editor later. To do this, use the standard Windows buttons available in the toolbar: **New**, **Open**, **Save**, **Save As**. Once the scripting project has been tested and is ready for deployment, you can load it into XMLSpy and run any of its macros or event handlers. For more information, see [Enabling Scripts and Macros](#)¹¹¹⁶.

You can also find an example scripting project at the following path: **C:\Users\\Documents\Altova\XMLSpy2024\Examples\SampleScripts.asprj**.

The next sections focus on the parts that your scripting project may need: global declarations, macros, forms, and events.

26.1.1.1 Overview of the Environment

The Scripting Editor consists of the following parts:

- Toolbar
- Project pane
- Properties pane
- Main window
- Toolbox

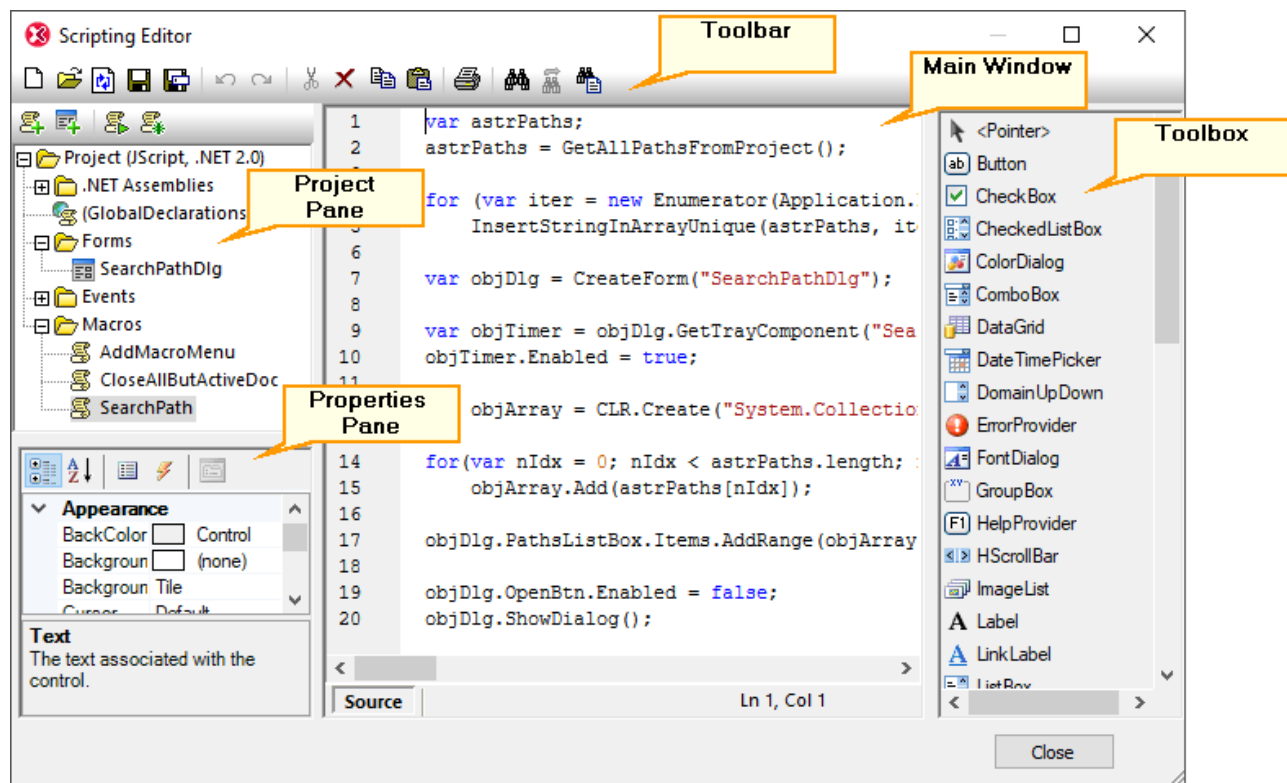

Toolbar

The toolbar includes standard Windows file management commands (**New**, **Open**, **Save**, **Save As**) and editor commands (**Copy**, **Cut**, **Delete**, **Paste**). When editing source code, the **Find** and **Replace** commands are additionally available, as well as the **Print** command.





Project pane

The project pane helps you view and manage the structure of the project. A scripting project consists of several components that can work together and may be created in any order:

- A "*Global Declarations*" script. As the name suggests, this script stores information available globally across the project. You can declare in this script any variables or functions that you need to be available in all forms, event handler scripts, and macros.
- *Forms*. Forms are typically necessary to collect user input, or provide some informative dialog boxes. A form is invoked by a call to it either within a function (in the Global Declarations script) or directly in a macro.
- *Events*. The "Events" folder displays XMLSpy application events provided by the COM API. To write a script that will be executed when an event occurs, double-click any event, and then type the handling code in the editor. The application events should not be confused with form events; the latter are handled at form level, as further detailed below.
- *Macros*. A macro is a script that can be invoked either on demand from a context menu or be executed automatically when XMLSpy starts. Macros do not have parameters or return values. A macro can access all variables and functions declared in the Global Declarations script and it can also display forms.

Right-click any of the components to see the available context menu commands and their shortcuts. Double-click any file (such as a form or a script) to open it in the main window.



The toolbar buttons provide the following quick commands:



-  **New macro** Adds a new macro to the project, in the **Macros** directory.
-  **New form** Adds a new form to the project, in the **Forms** directory.
-  **Run macro** Runs the selected macro.
-  **Debug macro** Runs the selected macro in debug mode.

Properties pane

The Properties pane is very similar to the one in Visual Studio. It displays the following:

- Form properties, when a form is selected
- Object properties, when an object in a form is selected
- Form events, when a form is selected
- Object events, when an object in a form is selected

To switch between the properties and events of the selected component, click the **Properties**  or **Events**  buttons, respectively.

The **Categorized**  and **Alphabetical**  icons display the properties or events either organized by category or organized in ascending alphabetical order.

When a property or event is selected, a short description of it is displayed at the bottom of the Properties pane.

Main window

The main window is the working area where you can enter source code or modify the design of the form. When editing forms, you can work in two tabs: the **Design** tab and the **Source** tab. The **Design** tab shows the layout of the form, while the **Source** tab contains the source code such as handler methods for the form events.

The source code editor provides code editing aids such as syntax coloring, source code folding, highlighting of starting and ending braces, zooming, autocompletion suggestions, bookmarks.

Autocompletion suggestions

JScript and VBScript are untyped languages, so autocompletion is limited to COM API names and XMLSpy built-in [commands](#)¹¹⁰⁶. The full method or property signature is shown next to the autocompletion entry helper.

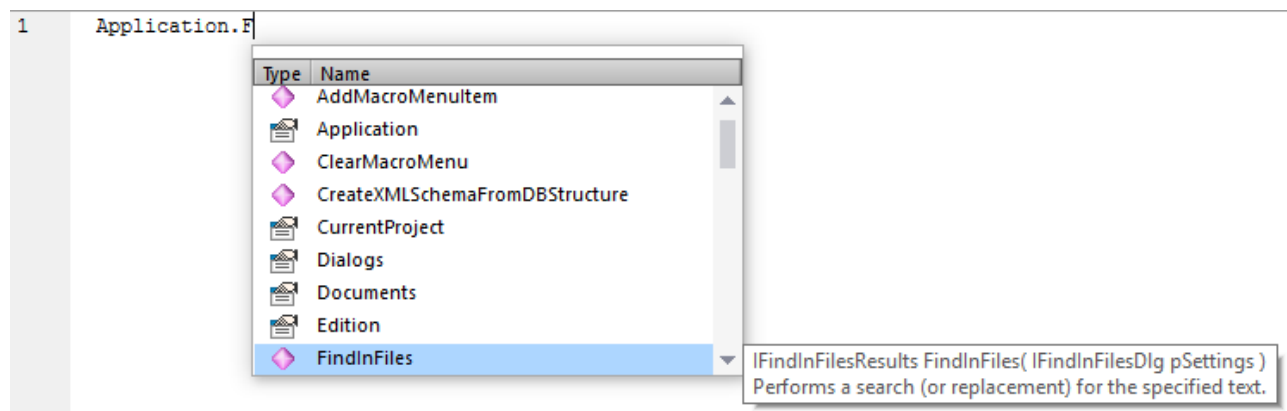

If names start with `objDocument`, `objProject`, `objXMLData`, or `objAuthenticRange`, members of the corresponding interface will be shown.

Placing the mouse over a known method or property displays its signature (and documentation if available), for example:

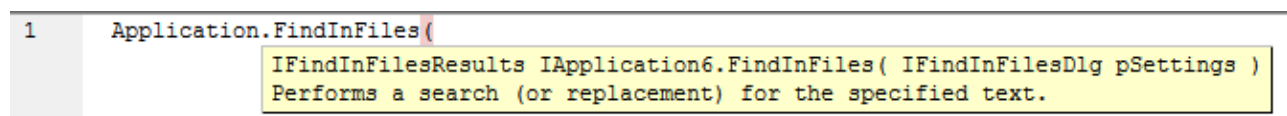

The auto-completion entry helper is normally shown automatically during editing, but it can also be obtained on demand by pressing **Ctrl+Space**.

Bookmarks

- To set or remove a bookmark, click inside a line, and then press **Ctrl+F2**
- To navigate to the next bookmark, press **F2**
- To navigate to the previous bookmark, press **Shift+F2**
- To delete all bookmarks, press **Ctrl+Shift+F2**

Zooming in/out

- To zoom in or out, hold the **Ctrl** key pressed and then press the "+" or "-" keys or rotate the mouse wheel.

Text view settings

To trigger text settings, right-click inside the editor, and select **Text View Settings** from the context menu.

Font settings

To change the font, right-click inside the editor, and select **Text View Font** from the context menu.

Toolbox

The Toolbox contains all the objects that are available for designing forms, such as buttons, text boxes, combo boxes, and so on.

To add a Toolbox item to a form:

1. Create or open a form and make sure that the **Design** tab is selected.
2. Click the Toolbox object (for example, **Button**), and then click at the location in the form where you wish to insert it. Alternatively, drag the object directly onto the form.

Some objects such as `Timer` are not added to the Form but are created in a tray at the bottom of the main window. You can select the object in the tray and set properties and event handlers for the object from the Properties pane. For an example of handling tray components from the code, see [Handling form events](#)^[1099].

You can also add registered ActiveX controls to the form. To do this, right-click the Toolbox area and select **Add ActiveX Control** from the context menu.

26.1.1.2 Global Declarations

The "Global Declarations" script is present by default in any scripting project; you do not need to create it explicitly. Any variables or functions that you add to this script are considered global across the entire project. Consequently, you can refer to such variables and functions from any of the project's macros and events. The following is an example of a global declarations script that imports the `System.Windows.Forms` namespace into the project. To achieve that, the code below invokes the `CLR.Import` command built into Scripting Editor.

```
// import System.Windows.Forms namespace for all macros, forms and events:  
CLR.Import( "System.Windows.Forms" );
```

Note: Every time a macro is executed or an event handler is called, the global declarations are re-initialized.

26.1.1.3 Macros

Macros are scripts that contain JScript (or VBScript, depending on your project's language) statements, such as variable declarations and functions.

If your projects should use macros, you can add them as follows: right-click inside the Project pane, select **Add Macro** from the context menu, and then enter the macro's code in the main form. The code of a macro could be as simple as an alert, for example:

```
alert("Hello, I'm a macro!");
```



More advanced macros can contain variables and local functions. Macros can also contain code that invokes forms from the project. The listing below illustrates an example of a macro that shows a form. It is assumed that this form has already been created in the "Forms" folder and has the name "SampleForm", see also [Forms](#) ¹⁰⁹⁸.

```
// display a form  
ShowForm( "SampleForm" );
```

In the code listing above, `ShowForm` is a command built into Scripting Editor. For reference to other similar commands that you can use to work with forms and .NET objects, see the [Built-in Commands](#) ¹¹⁰⁶.

You can add multiple macros to the same project, and you can designate any macro as "auto-macro". When a macro is designated as "auto-macro", it runs automatically when XMLSpy starts. To designate a macro as auto-macro, right-click it, and select **Set as Auto-Macro** from the context menu.

Only one macro can be run at a time. After a macro (or event) is executed, the script is closed and global variables lose their values.

To run a macro directly in Script Editor, click **Run Macro** . To debug a macro using the Visual Studio debugger, click **Debug Macro** . For information about enabling and running macros in XMLSpy, see [Enabling Scripts and Macros](#) ¹¹¹⁶.

26.1.1.4 Forms

Forms are particularly useful if you need to collect input data from users or display data to users. A form can contain miscellaneous controls to facilitate this, such as buttons, check boxes, combo boxes, and so on.

To add a form, right-click inside the Project pane, and then select **Add Form** from the context menu. To add a control to a form, drag it from the Toolbox available to the right side of Scripting Editor and drop it onto the form.

You can change the position and size of the controls directly on the form, by using the handles that appear when you click any control, for example:

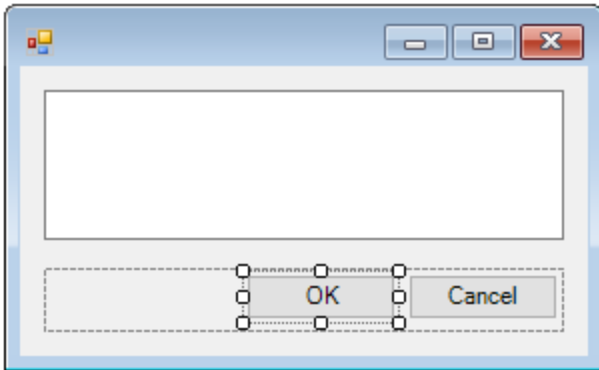

All form controls have properties that you can easily adjust in the Properties pane. To do this, first select the control on the form, and then edit the required properties in the Properties pane.

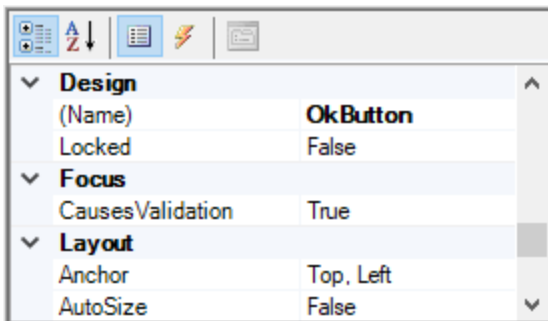

Handling form events

Each form control also exposes various events to which your scripting project can bind. For example, you might want to invoke some XMLSpy COM API method whenever a button is clicked. To create a function that binds to a form event, do the following:

1. In the Properties pane, click **Events** .
2. In the **Action** column, double-click the event where you need the method (for example, in the image below, the handled event is "Click").

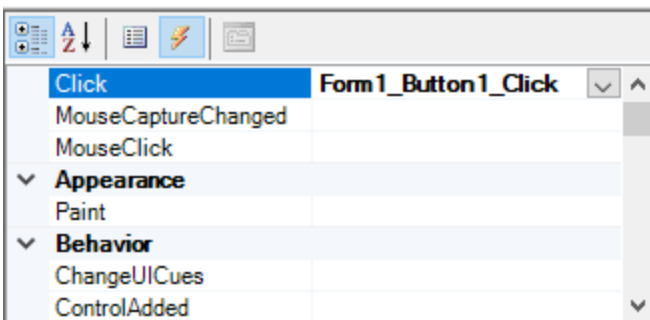

You can also add handler methods by double-clicking a control on the form. For example, double-clicking a button in the form design generates a handler method for the "Click" event of that button.

Once the body of the handler method is generated, you can type code that handles this event, for example:

```
//Occurs when the component is clicked.
function MyForm_ButtonClick( objSender, e_EventArgs )
{
    alert("A button was clicked");
}
```

To display a work-in-progress form detached from the Scripting Editor, right-click the form in the Project window, and select **Test Form** from the context menu. Note that the **Test Form** command just displays the form; the form's events (such as button clicks) are still disabled. To have the form react to events, call it from a macro, for example:

```
// Instantiate and display a form
ShowForm( "SampleForm" );
```

Accessing form controls

You can access any components on a form from your code by using field access syntax. For example, suppose there is a form designed as follows:

```
// MyForm
//   ButtonPanel
//     OkButton
//     CancelButton
//   TextEditor
//     AxMediaPlayer1
// TrayComponents
//   MyTimer
```

The code below shows how to instantiate the form, access some of its controls using field access syntax, and then display the form:

```
// Instantiate the form
var objForm = CreateForm("MyForm");
// Disable the OK button
objForm.ButtonPanel.OkButton.Enabled = false;
// Change the text of TextEditor
objForm.TextEditor.Text = "Hello";
// Show the form
objForm.ShowDialog();
```

When you add certain controls such as timers to the form, they are not displayed on the form; instead, they are shown as tray components at the base of the form design, for example:

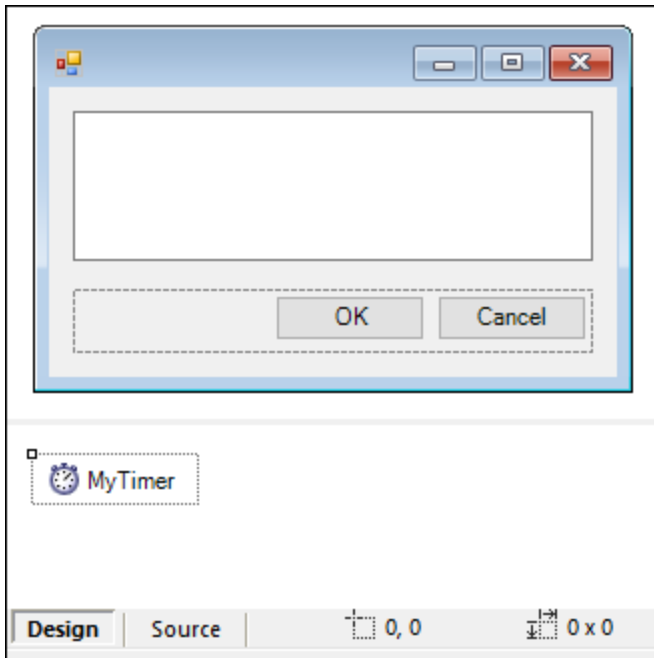

To access controls from the tray, use the `GetTrayComponent` method on the form object, and supply the name of the control as argument. In this example, to get a reference to `MyTimer` and enable it, use the following code:

```
var objTimer = objForm.GetTrayComponent("MyTimer");
objTimer.Enabled = true;
```

For ActiveX Controls, you can access the underlying COM object via the `OCX` property:

```
var ocx = lastform.AxMediaPlayer1.OCX; // get underlying COM object
ocx.enableContextMenu = true;
ocx.URL = "mms://apasf.apa.at/fm4_live_worldwide";
```

26.1.1.5 Events

Your scripting project may optionally include scripts that handle XMLSpy events such as opening, closing, or saving a document, starting or closing XMLSpy, adding an element to a diagram, and others. These events are provided by the XMLSpy COM API, and you can find them in the "Events" folder of your scripting project. Note that these events are XMLSpy-specific, as opposed to form events. Events are organized into folders as follows:

- Application Events
- Document Events
- AuthenticView Events
- GridView Events
- TextView Events

To create an event handler script, right-click an event, and select **Open** from the context menu (or double-click the event). The event handler script is displayed in the main window, where you can start editing it. For example, the event handler illustrated below displays an alert each time XMLSpy starts:

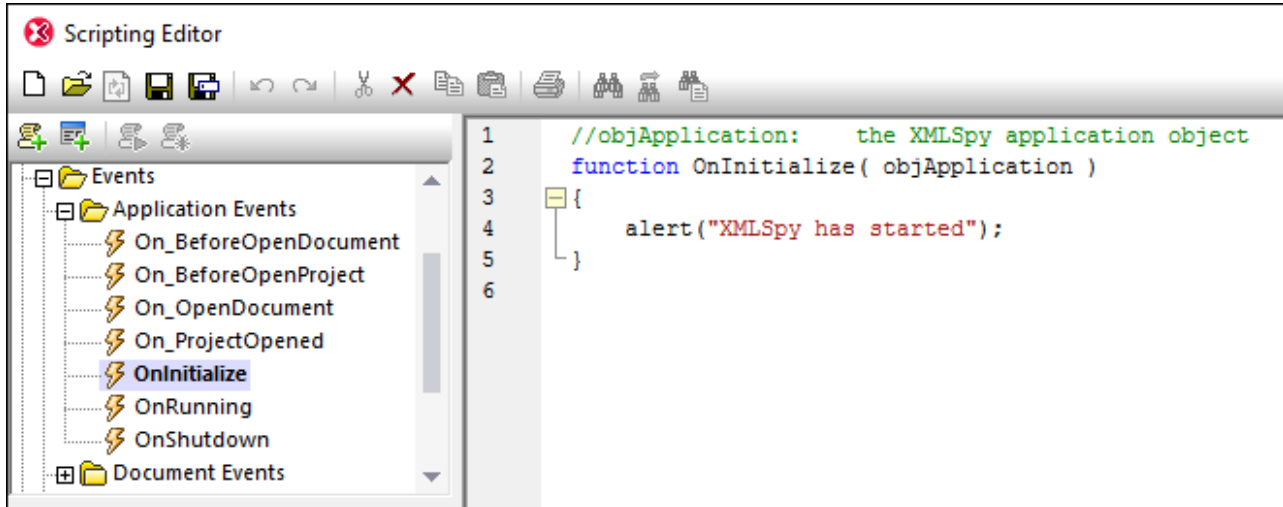

Note the following:

- The `alert` command is applicable to JScript. The VBScript equivalent is `MsgBox`. See also [alert](#)¹¹⁰⁷.
- The name of the event handler function must not be changed; otherwise, the event handler script will not be called.
- In order for events to be processed, the **Process Events** check box must be selected when you enable the scripting project in XMLSpy. For more information, see [Enabling Scripts and Macros](#)¹¹¹⁶.

You can optionally define local variables and helper functions within event handler scripts, for example:

```

var local;

function OnInitialize( objApplication )
{
    local = "OnInitialize";
    Helper();
}

function Helper()
{
    alert("I'm a helper function for " + local);
}

```

26.1.1.6 JScript Programming Tips

Below are a few JScript programming tips that you may find useful while developing a scripting project in XMLSpy Scripting Editor.

Out parameters

Out parameters from methods of the .NET Framework require special variables in JScript. For example:

```
var dictionary =
CLR.Create("System.Collections.Generic.Dictionary<System.String, System.String>");
dictionary.Add("1", "A");
dictionary.Add("2", "B");

// use JScript method to access out-parameters
var strOut = new Array(1);
if ( dictionary.TryGetValue("1", strOut) ) // TryGetValue will set the out parameter
    alert( strOut[0] ); // use out parameter
```

Integer arguments

.NET Methods that require integer arguments should not be called directly with JScript number objects which are floating point values. For example, instead of:

```
var objCustomColor = CLR.Static("System.Drawing.Color").FromArgb(128,128,128);
```

use:

```
var objCustomColor =
CLR.Static("System.Drawing.Color").FromArgb(Math.floor(128),Math.floor(128),Math.floor(128));
```

Iterating .NET collections

To iterate .NET collections, the JScript Enumerator as well as the .NET iterator technologies can be used, for example:

```
// iterate using the JScript iterator
var itr = new Enumerator( coll );
for ( ; !itr.atEnd(); itr.moveNext() )
    alert( itr.item() );

// iterate using the .NET iterator
var itrNET = coll.GetEnumerator();
while( itrNET.MoveNext() )
    alert( itrNET.Current );
```

.NET templates

.NET templates can be instantiated as shown below:

```
var coll = CLR.Create( "System.Collections.Generic.List<System.String>" );
```

or

```
CLR.Import( "System" );
CLR.Import( "System.Collections.Generic" );
var dictionary = CLR.Create( "Dictionary<String,Dictionary<String,String>>" );
```

.NET enumeration values

.NET enumeration values are accessed as shown below:

```
var enumValStretch = CLR.Static( "System.Windows.Forms.ImageLayout" ).Stretch;
```

Enumeration literals

The enumeration literals from the XMLSpy API can be accessed as shown below (there is no need to know their numerical value).

```
objExportXMIFileDialog.XMIType = eXMI21ForUML23;
```

26.1.1.7 Example Scripting Project

A demo project that illustrates scripting with XMLSpy is available at the following path: **C:\Users\<user>\Documents\Altova\XMLSpy2024\Examples\SampleScripts.asprj**. This scripting project consists of a few macros and a Windows form.

To load the scripting project into Scripting Editor:

1. On the **Tools** menu, click **Scripting Editor**.
2. Click **Open** and browse for the **SampleScripts.asprj** file from the path above.

The project contains several macros in the "Macros" directory.

| Macro | Description |
|----------------------------------|--|
| AddMacroMenu | <p>This macro adds a new menu item to XMLSpy, by invoking the <code>Application.AddMacroMenuItem</code> method of the COM API. The first argument of the <code>AddMacroMenuItem</code> method is the name of the macro to be added (in this example, "CloseAllButActiveDoc") and the second argument is the display text for the menu item.</p> <p>Whenever this macro is run, a new menu command called "CloseAllButActiveDoc" is added under the Tools menu. To clear macro menu items created previously, either restart XMLSpy or create a macro that calls the <code>Application.ClearMacroMenu</code> API method.</p> |
| CloseAllButActiveDocument | <p>When executed, the macro iterates through the currently open documents in XMLSpy and closes all of them, except for the active document.</p> |

| | |
|--------------------------|--|
| <p>SearchPath</p> | <p>This macro displays a form that lets users perform search for files within the current project. The form is available in the "Forms" directory, where you can view its design and the associated event handlers.</p> <p>The <code>GetAllPathsFromProject()</code> method returns all the file paths that belong to the currently opened project, as an array. The definition of this method is in the GlobalDeclarations script of the project. The <code>InsertStringInArrayUnique</code> method ensures that only unique paths are added to the array. Next, the form is initialized with CreateForm¹¹¹². Finally, the array is converted to a .NET type with the help of the CLR.Create¹¹⁰⁸ method and the form is populated with the resulting <code>ArrayList</code> collection.</p> <p>The Open button of the form has a handler that calls the <code>Application.Documents.OpenFile</code> API method to open the currently selected file.</p> |
|--------------------------|--|

To enable the scripting project as global XMLSpy scripting project:

1. On the **Tools** menu, click **Options**.
2. Click the **Scripting** tab.
3. Under "Global scripting project file", click **Browse** and select the **SampleScripts.asprj** file from the path above.
4. This scripting project does not have auto-macros and application event handlers; therefore, you don't need to select either the **Run auto-macros...** or **Process events** check boxes.
5. Click **Apply**.

At this stage, several new menu items (one for each macro) become available under the **Tools | Macros** menu.

To run the "SearchPath" macro:

1. Open an XMLSpy project that contains several files (in this example, **C:\Users\<user>\Documents\Altova\XMLSpy2024\Examples\Examples.spp**).
2. On the **Tools** menu, click **Macros**, and then click **Search Path**.
3. Type the search term (in this example, ".xml").

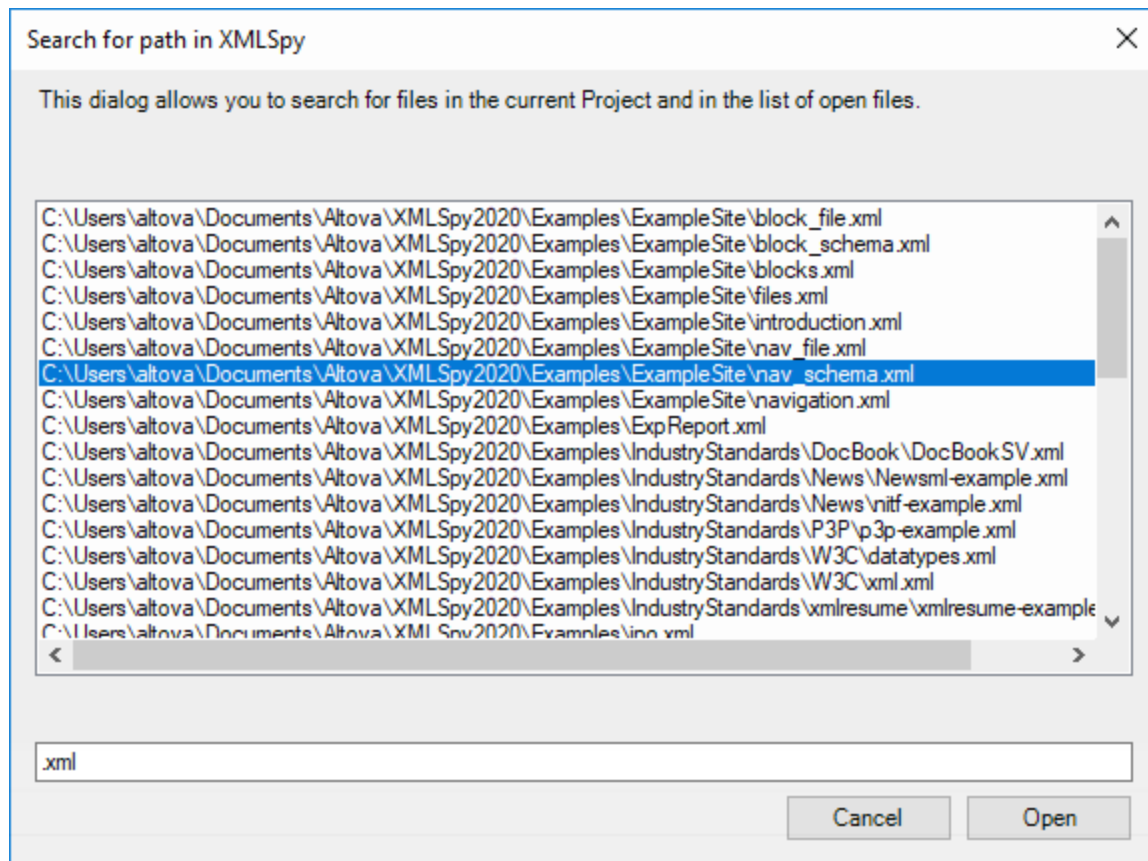

As shown above, all file names that contain the search term are now listed. You can click any element in the list, and then click **Open** to display it in the main editor.

26.1.2 Built-in Commands

This section provides reference to all the commands you can use in the XMLSpy Scripting Editor.

- [alert](#) ¹¹⁰⁷
- [confirm](#) ¹¹⁰⁷
- [CLR.Create](#) ¹¹⁰⁸
- [CLR.Import](#) ¹¹⁰⁹
- [CLR.LoadAssembly](#) ¹¹⁰⁹
- [CLR.ShowImports](#) ¹¹¹⁰
- [CLR.ShowLoadedAssemblies](#) ¹¹¹¹
- [CLR.Static](#) ¹¹¹¹
- [CreateForm](#) ¹¹¹²
- [doevents](#) ¹¹¹³
- [lastform](#) ¹¹¹³
- [prompt](#) ¹¹¹⁴
- [ShowForm](#) ¹¹¹⁵
- [watchdog](#) ¹¹¹⁵

26.1.2.1 alert

Displays a message box that shows a given message and the "OK" button. To proceed, the user will have to click "OK".

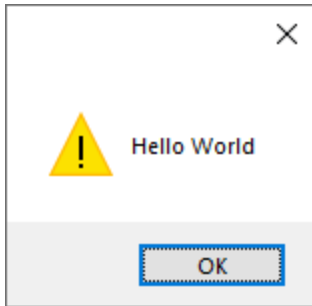

Signature

For JScript, the signature is:

```
alert(strMessage : String) -> void
```

For VBScript, the signature is:

```
MsgBox(strMessage : String) -> void
```

Example

The following JScript code displays a message box with the text "Hello World".

```
alert("Hello World");
```

26.1.2.2 confirm

Opens a dialog box that shows a given message, a confirmation button, and a cancel button. The user will have to click either "OK" or "Cancel" to proceed. Returns a Boolean that represents the user's answer. If the user clicked "OK", the function returns **true**; if the user clicked "Cancel", the function returns **false**.

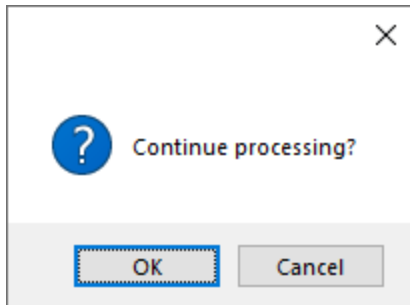

Signature

```
confirm(strMessage : String) -> result : Boolean
```

Example (JScript)

```
if ( confirm( "Continue processing?" ) == false )
    alert("You have cancelled this action");
```

Example (VBScript)

```
If ( confirm( "Continue processing?" ) = false ) Then
    MsgBox ("You have cancelled this action")
End If
```

26.1.2.3 CLR.Create

Creates a new .NET object instance of the type name supplied as argument. If more than one argument is passed, the successive arguments are interpreted as the arguments for the constructor of the .NET object. The return value is a reference to the created .NET object

Signature

```
CLR.Create(strTypeNameCLR : String, constructor arguments ... ) -> object
```

Example

The following JScript code illustrates how to create instances of various .NET classes.

```
// Create an ArrayList
var objArray = CLR.Create("System.Collections.ArrayList");
// Create a ListViewItem
var newItem = CLR.Create( "System.Windows.Forms.ListViewItem", "NewItemText" );
// Create a List<string>
```



```
var coll = CLR.Create( "System.Collections.Generic.List<System.String>" );
// Import required namespaces and create a Dictionary object
CLR.Import( "System" );
CLR.Import( "System.Collections.Generic" );
var dictionary = CLR.Create( "Dictionary<String, Dictionary<String, String >>" );
```

26.1.2.4 CLR.Import

Imports a namespace. This is the scripting equivalent of C# `using` and VB.Net `imports` keyword. Calling `CLR.Import` makes it possible to leave out the namespace part in subsequent calls like `CLR.Create()` and `CLR.Static()`.

Note: Importing a namespace does not add or load the corresponding assembly to the scripting project. You can add assemblies to the scripting project dynamically (at runtime) in the source code by calling [CLR.LoadAssembly](#)¹¹⁰⁸.

Signature

```
CLR.Import(strNamespaceCLR : String) -> void
```

Example

Instead of having to use fully qualified namespaces like:

```
if ( ShowForm( "FormName" ) == CLR.Static( "System.Windows.Forms.DialogResult" ).OK )
{
    var sName = lastform.textboxFirstName.Text + " " + lastform.textboxLastName.Text;
    CLR.Static( "System.Windows.Forms.MessageBox" ).Show( "Hello " + sName );
}
```

One can import namespaces first and subsequently use the short form:

```
CLR.Import( "System.Windows.Forms" );

if ( ShowForm( "FormName" ) == CLR.Static( "DialogResult" ).OK )
{
    var sName = lastform.textboxFirstName.Text + " " + lastform.textboxLastName.Text;
    CLR.Static( "MessageBox" ).Show( "Hello " + sName );
}
```

26.1.2.5 CLR.LoadAssembly

Loads the .NET assembly with the given long assembly name or file path. Returns Boolean **true** if the assembly could be loaded; **false** otherwise.

Signature

```
CLR.LoadAssembly(strAssemblyNameCLR : String, showLoadErrors : Boolean) -> result : Boolean
```

Example

The following JScript code attempts to set the clipboard text by loading the required assembly dynamically.

```
// set clipboard text (if possible)
// System.Windows.Clipboard is part of the PresentationCore assembly, so load this
// assembly first:
if ( CLR.LoadAssembly( "PresentationCore, Version=3.0.0.0, Culture=neutral,
PublicKeyToken=31bf3856ad364e35", true ) )
{
    var clipboard = CLR.Static( "System.Windows.Clipboard" );
    if ( clipboard != null )
        clipboard.SetText( "HelloClipboard" );
}
```

26.1.2.6 CLR.ShowImports

Opens a message box that shows the currently imported namespaces. The user will have to click "OK" to proceed.

Signature

```
CLR.ShowImports() -> void
```

Example

The following JScript code first imports a namespace, and then displays the list of imported namespaces:

```
CLR.Import( "System.Windows.Forms" );
CLR.ShowImports();
```

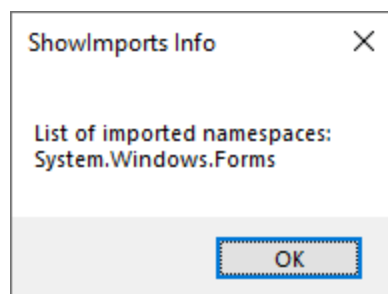

26.1.2.7 CLR.ShowLoadedAssemblies

Opens a message box that shows the currently loaded assemblies. The user will have to click "OK" to proceed.

Signature

```
CLR.ShowLoadedAssemblies() -> void
```

Example

```
CLR.ShowLoadedAssemblies();
```

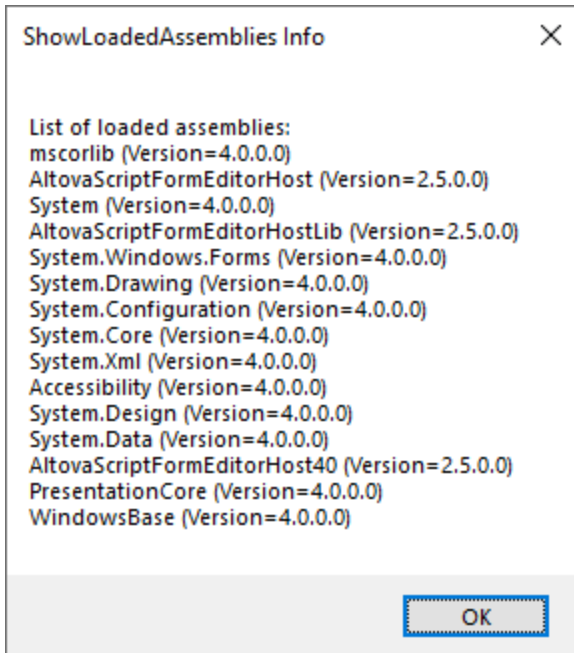

26.1.2.8 CLR.Static

Returns a reference to a static .NET object. You can use this function to get access to .NET types that have no instances and contain only static members.

Signature

```
CLR.Static(strTypeNameCLR : String) -> object
```

Example (JScript)

```
// Get the value of a .NET Enum into a variable
var enumValStretch = CLR.Static( "System.Windows.Forms.ImageLayout" ).Stretch

// Set the value of the Windows clipboard
var clipboard = CLR.Static( "System.Windows.Clipboard" );
clipboard.SetText( "HelloClipboard" );

// Check the buttons pressed by the user on a dialog box
if ( ShowForm( "FormName" ) == CLR.Static( "System.Windows.Forms.DialogResult" ).OK )
    alert( "ok" );
else
    alert( "cancel" );
```

26.1.2.9 CreateForm

Instantiates the `Form` object identified by the name supplied as argument. The form must exist in the "Forms" folder of the scripting project. Returns the form object (`System.Windows.Forms.Form`) corresponding to the given name, or `null` if no form with such name exists.

Signature

```
CreateForm (strFormName : String) -> System.Windows.Forms.Form | null
```

Example

Let's assume that a form called "FormName" exists in the scripting project.

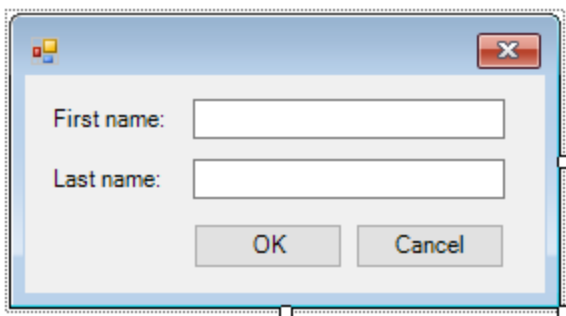

The following JScript code instantiates the form with some default values and displays it to the user.

```
var myForm = CreateForm( "FormName" );
if ( myForm != null )
{
    myForm.textboxFirstName.Text = "Daniela";
    myForm.textboxLastName.Text = "Heidegger";
}
```

```
var dialogResult = myForm.ShowDialog();  
}
```

The `dialogResult` can subsequently be evaluated as follows:

```
if ( dialogResult == CLR.Static( "System.Windows.Forms.DialogResult" ).OK )  
    alert( "ok" );  
else  
    alert( "cancel" );
```

Note: The code above will work only if the **DialogResult** property of the "OK" and "Cancel" buttons is set correctly from the Properties pane (for example, it must be **OK** for the "OK" button).

26.1.2.10 `doevents`

Processes all Windows messages currently in the message queue.

Signature

```
doevents() -> void
```

Example (JScript)

```
for ( i=0; i < nLongLastingProcess; ++i )  
{  
    // do long lasting process  
  
    doevents(); // process Windows messages; give UI a chance to update  
}
```

26.1.2.11 `lastform`

This is a global field that returns a reference to the last form object that was created via `CreateForm()` or `ShowForm()`.

Signature

```
lastform -> formObj : System.Windows.Forms.Form
```

Example

The following JScript code shows the form "FormName" as a dialog box.

```
CreateForm( "FormName" );  
if ( lastform != null )
```

```
{  
  lastform.textBoxFirstName.Text = "Daniela";  
  lastform.textBoxLastName.Text = "Heidegger";  
  var dialogResult = lastform.ShowDialog();  
}
```

The values of both textbox controls are initialized with the help of `lastform`.

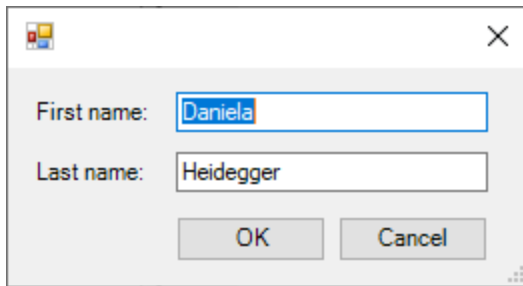

26.1.2.12 prompt

Opens a dialog box that shows a message and a textbox control with a default answer. This can be used to let the user input a simple string value. The return value is a string that contains the textbox value or null if the user selected "Cancel".

Signature

```
prompt(strMessage : String, strDefault : String) -> val : String
```

Example

```
var name = prompt( "Please enter your name", "Daniel Smith" );  
if ( name != null )  
  alert( "Hello " + name + "!" );
```

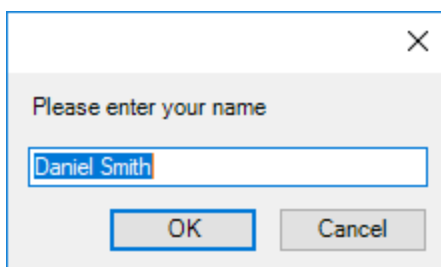

26.1.2.13 ShowForm

Instantiates a new form object from the given form name and immediately shows it as dialog box. The return value is an integer that represents the generated `DialogResult` (`System.Windows.Forms.DialogResult`). For the list of possible values, refer to the documentation of the `DialogResult` Enum (<https://docs.microsoft.com/en-us/dotnet/api/system.windows.forms.dialogresult?view=netframework-4.8>).

Signature

```
ShowForm(strFormName : String) -> result : Integer
```

Example

The following JScript code

```
var dialogResult = ShowForm( "FormName" );
```

Shows the form "FormName" as a dialog box:

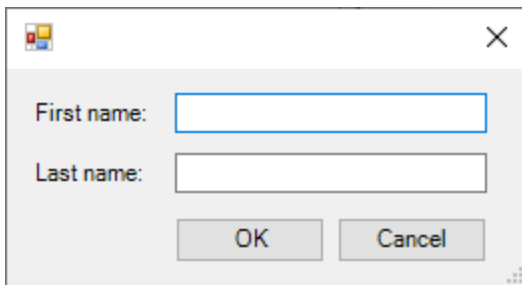

The `DialogResult` can subsequently be evaluated, for example:

```
if ( dialogResult == CLR.Static( "System.Windows.Forms.DialogResult" ).OK )  
    alert( "ok" );  
else  
    alert( "cancel" );
```

Note: The code above will work only if the **DialogResult** property of the "OK" and "Cancel" buttons is set correctly from the Properties pane (for example, it must be **OK** for the "OK" button).

26.1.2.14 watchdog

Long running CPU-intensive scripts may ask the user if the script should be terminated. The `watchdog()` method is used to disable or enable this behavior. By default, the watchdog is enabled.

Calling `watchdog(true)` can also be used to reset the watchdog. This can be useful before executing long running CPU-intensive tasks to ensure they have the maximum allowed script processing quota.

Signature

```
watchdog(bEnable : boolean) -> void
```

Example

```
watchdog( false ); // disable watchdog - we know the next statement is CPU intensive but
it will terminate for sure
doCPUIntensiveScript();
watchdog( true ); // re-enable watchdog
```

26.1.3 Enabling Scripts and Macros

Once a scripting project is complete and tested, you can use it in the following ways:

1. As the global scripting project for XMLSpy. This means that all the scripts and macros from the scripting project are available to XMLSpy.
2. At XMLSpy project level. This means that a reference to the .asprj file is saved together with the XMLSpy project. When the XMLSpy project is opened, its associated scripts and macros can be called.

To set a scripting project as global:

1. On the **Tools** menu, click **Options**.
2. Click the **Scripting** tab.
3. Select the **Activate scripting** check box and browse for the .asprj file to be used as global scripting project.

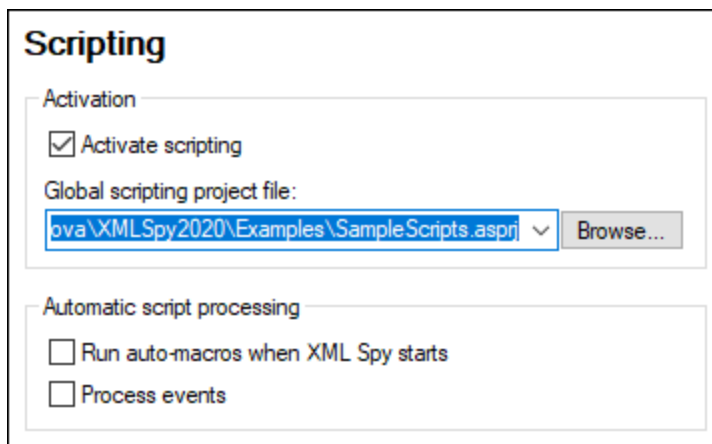

You can optionally enable the following additional script processing options:

| | |
|--|--|
| <p>Run auto-macros when XMLSpy starts</p> | <p>If you select this check box, any macros that were set as "Auto-macro" in the project will be triggered</p> |
|--|--|

| | |
|-----------------------|---|
| | automatically when XMLSpy starts. |
| Process events | Select this check box if your scripts bind to any application events. Clear the check box to prevent the scripts from reacting to events. |

To enable a scripting project at project level:

1. Open the project.
2. On the **Project** menu, click **Script Settings**.
3. Select the **Activate project scripts** check box and browse for the .asprj file.

The **Run-auto macros...** check box has the same meaning as already described above.

26.1.3.1 Running Macros

When a scripting project is active in XMLSpy, any macros available in that project are displayed in the **Tools | Macros** menu. Therefore, you can run a macro at any time, by triggering the respective menu command, for example **Tools | Macros | <SomeMacro>**.

Macros that were configured as auto-macros will run automatically whenever XMLSpy starts, provided that this behavior is enabled from options, as described in [Enabling Scripts and Macros](#)¹¹¹⁶.

For convenience, you can create toolbar buttons for macros, as follows:

1. On the **Tools** menu, click **Customize**.
2. Click the **Macros** tab. Any macros that are available at application level (in the *global* scripting project) are listed.
3. Click **Add Command**.

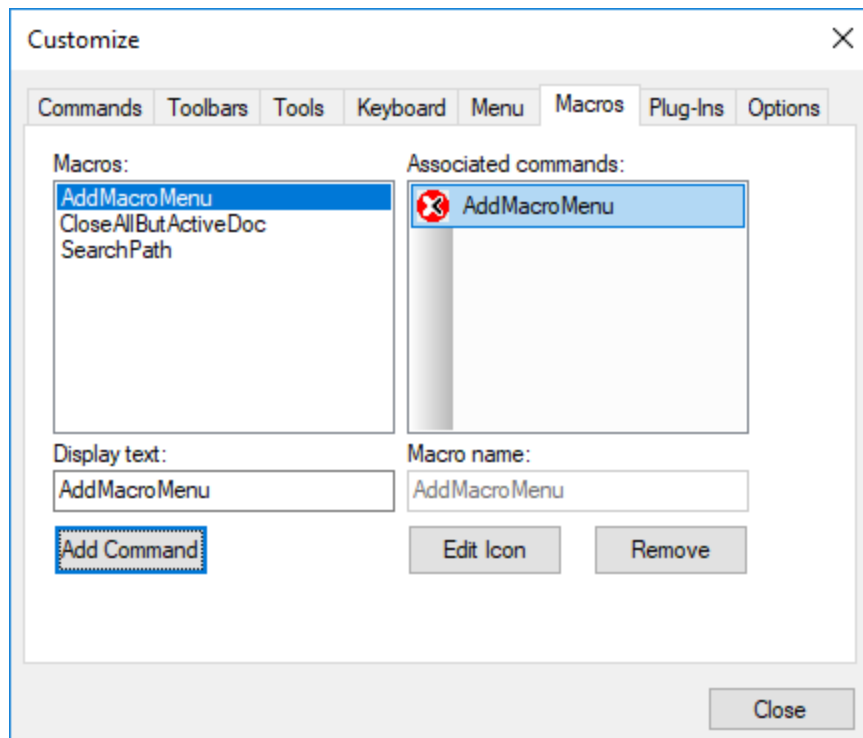

4. Optionally, click **Edit icon** and draw a new icon for the new macro. You can also assign a shortcut to the macro, from the **Keyboard** tab.
5. Drag the macro from the **Associated commands** pane onto the toolbar where you would like it to appear.

To remove a macro from a toolbar:

1. On the **Tools** menu, click **Customize**.
2. Click the **Macros** tab.
3. Drag the macro from the toolbar where it appears back into the **Associated commands** pane.

26.2 IDE Plugins

XMLSpy allows you to create your own IDE plug-ins and integrate them into XMLSpy.

Use plug-ins to:

- Configure your version of XMLSpy, add commands through menus, icons, buttons etc.
- React to events from XMLSpy.
- Run your specific code within XMLSpy with access to the complete XMLSpy API

XMLSpy expects your plug-in to implement the [IXMLSpyPlugin](#)¹¹²⁸ interface. C# and C++ are the currently supported languages, and examples using these languages are included with your installation package and are located in the `XMLSpy2024\Examples\IDEPlugin` folder of your XMLSpy installation.

| | |
|----------------------|-------------------------------|
| Windows 7, 8, 10, 11 | C:/Users/<username>/Documents |
|----------------------|-------------------------------|

See [ATL sample files](#)¹¹²³ for an example using C++.

26.2.1 Registration of IDE Plugins

XMLSpy maintains a specific key in the Registry where it stores all registered IDE plug-ins:

```
HKEY_CURRENT_USER\Software\Altova\XML Spy\PlugIns
```

All values of this key are treated as references to registered plug-ins and must conform to the following format:

| | |
|-------------|------------------------|
| Value name: | ProgID of the plug-in |
| Value type: | must be REG_SZ |
| Value data: | CLSID of the component |

Each time the application starts the values of the `PlugIns` key is scanned, and the registered plug-ins are loaded.

Register plug-in manually

To register a plug-in manually, use the Customize dialog box of XMLSpy's **Tools** menu. Use the **Add Plug-In** button to specify the DLL that implements your plug-in. XMLSpy registers the DLL as a COM server and adds the corresponding entry in its `PlugIns` key.

If you experience problems with manual registration, check whether the CLSID of your plug-in is correctly registered in the `PlugIns` key. If the registration is incorrect, then the name of your plug-in DLL was probably not sufficiently unique. Use a different name or perform direct registration.

Register plug-in directly

A plug-in can be directly registered as an IDE plug-in by first registering the DLL and then adding the appropriate value to the `Plugins` key of XMLSpy. (This can be done, for example, during plug-in setup.) The new plug-in will be activated the next time XMLSpy is launched.

Creating plug-ins

Source code for sample plug-ins has been provided in the application's [\(My\) Documents folder](#)²⁸: `Examples\IDEPlugin` folder. To build a plug-in from such source code, do the following:

1. Open the solution you want to build as a plug-in in Visual Studio.
2. Build the plug-in with the command in the Build menu.
3. The plug-in's DLL file will be created in the `Bin` or `Debug` folder. This DLL file is the file that must be added as a plug-in (see above).

Note: C# and C++ are the currently supported languages.

26.2.2 ActiveX Controls

ActiveX controls are supported. Any IDE PlugIn which is also an ActiveX control will be displayed in a Dialog Control Bar. A sample PlugIn that is also an ActiveX control is included in the `IDEPlugin` folder in the `Examples` folder of your application folder.

26.2.3 Configuration XML

The IDE plug-in allows you to change the user interface (UI) of XMLSpy. This is done by describing each separate modification using an XML data stream. The XML configuration is passed to XMLSpy using the [GetUIModifications](#)¹¹³² method of the `IXMLSpyPlugIn` interface.

The XML file containing the UI modifications for the IDE PlugIn, must have the following structure:

```
<ConfigurationData>
  <ImageFile>Path to image file</ImageFile>
  <Modifications>
    <Modification>
      ...
    </Modification>
    ...
  </Modifications>
</ConfigurationData>
```

You can define icons or toolbar buttons for new menu items that are added to the UI of XMLSpy by the plug-in. The path to the file containing the images is set using the `ImageFile` element. Each image must be 16x16 pixels using maximum 256 colors. The image references must be arranged from left to right in a single `<ImageFile>` element. The rightmost image index value is zero.

The **Modification** element can have any number of **Modification** child elements. Each **Modification** element defines a specific change to the standard UI of XMLSpy. The modifications you can carry out are described in the next section below.

Structure of Modification elements

A **Modification** element has two child elements:

```
<Modification>
  <Action>Type of action</Action>
  <UIElement Type="Type of UI element" />
</Modification>
```

Valid values for the **Action** element are:

Add: to add the following UI element to XMLSpy

Hide: to hide the following UI element in XMLSpy

Remove: to remove the UI element from the "Commands" list box, in the customize dialog

Multiple modifications can be combined in an **Action** element, like this: "**Add Hide**"

The **UIElement** element defines any new or existing UI element and may be one of the the following types: toolbars, buttons, menus, or menu items. The **type** attribute specifies which of these types the UI element belongs to. The structure of **UIElement** is described in the sections below.

Common UIElement children

The **ID** and **Name** elements are defined for all types of UI element. In the case of some types, however, one of these elements is ignored. For example, **Name** is ignored for a separator.

```
<ID></ID>
<Name></Name>
```

If **UIElement** describes an existing element of the UI, the value of the **ID** element is predefined by XMLSpy. Normally these ID values are not known to the public. If the XML fragment describes a new part of the UI, then the ID is arbitrary and the value should be less than 1000. The **Name** element sets the textual value. Existing UI elements can be identified just by name; for example, menus and menu items that have sub menus. For new UI elements, the **Name** element sets the caption (for example, the title of a toolbar) or the text of a menu item.

Toolbars and Menus

To define a toolbar it is necessary to specify the ID and/or the name of the toolbar. An existing toolbar can be specified using only the name or ID (if the latter is known). To create a **new** toolbar, both values must be set. The **type** attribute must have a value of **ToolBar**.

```
<UIElement Type="ToolBar">
  <ID>1</ID>
  <Name>TestPlugIn</Name>
</UIElement>
```

To specify an XMLSpy menu you need two parameters:

- The ID of the menu bar which contains the menu. If no XML documents are open in the main window, the menu bar ID is 128. If one or more XML documents are open, the menu bar ID is 129.
- The menu name. Menus do not have an associated ID value. The following example defines the "Edit" menu of the menu bar which is active, when at least one XML document is open:

```
<UIElement Type="Menu">
  <ID>129</ID>
  <Name>Edit</Name>
</UIElement>
```

An additional element is used if you want to create a new menu. The `Place` element defines the position of the new menu in the menu bar:

```
<UIElement Type="Menu">
  <ID>129</ID>
  <Name>PlugIn Menu</Name>
  <Place>12</Place>
</UIElement>
```

A value of `-1` for the `Place` element sets the new button or menu item at the end of the menu or toolbar.

Commands

If you add a new command (through a toolbar button or a menu item), the `UIElement` fragment can contain any of these sub elements:

```
<MacroName></MacroName>
<Info></Info>
<ImageID></ImageID>
```

If `MacroName` is specified, XMLSpy searches for a macro with the same name in the scripting environment and executes it each time this command is processed. The `Info` element contains a description string that is displayed in the status bar when the mouse pointer is over the associated command (button or menu item). `ImageID` defines the index of the icon in the image file. Note that all icons are stored in one image file.

To define a toolbar button, create an `UIElement` with this structure:

```
<UIElement Type="ToolBarItem">
  <!--don't reuse local IDs even the commands do the same-->
  <ID>5</ID>
  <Name>Open file from repository...</Name>
  <!--Set Place To -1 If this is the first button To be inserted-->
  <Place>-1</Place>
  <ImageID>0</ImageID>
  <ToolBarID>1</ToolBarID>
  <!--instead of the toolbar ID the toolbar name could be used-->
  <ToolBarName>TestPlugIn</ToolBarName>
</UIElement>
```

Additional elements to declare a toolbar button are `Place`, `ToolBarID` and `ToolBarName`. The `ToolBarID` and `ToolBarName` elements are used to identify the toolbar which contains the new or existing button. The textual value of `ToolBarName` is case-sensitive. The (UIElement) `type` attribute must be `ToolBarItem`.

To define a menu item, the elements `MenuItem`, `Place` and `Parent` are available in addition to the standard elements used to declare a command. The content of the `MenuItem` element can be either 128 or 129. See the section "Toolbars and Menus" above for more information.

The `Parent` element is used to identify the menu where the new menu entry should be inserted. As sub menu items have no unique Windows ID, we need some other way to identify the parent of the menu item. We do this by setting the content of the `Parent` element to be the path to the menu item. The steps in the path are indicated by a colon. The pattern would be `ParentMenu:SubMenu`. If the menu has no parent (because it is not a submenu), add a colon to the beginning of the name (see example below). The `type` attribute must be set to `MenuItem`.

The example below defines a menu item, where the containing menu is not a sub menu:

```
<UIElement Type="MenuItem">
  <!--the following element is a Local command ID-->
  <ID>3</ID>
  <Name>Open file from repository...</Name>
  <Place>-1</Place>
  <MenuItem>129</MenuItem>
  <Parent>:PlugIn Menu</Parent>
  <ImageID>0</ImageID>
</UIElement>
```

You can add toolbar separators and menus if the value of the `ID` element is set to 0.

26.2.4 ATL Sample Files

This section shows how to create a simple XMLSpy IDE plug-in DLL using ATL. You must know how to work with MS VisualStudio, ATL, and the wizards that generate new ATL objects. To access the API, the implementation imports the Type Library of XMLSpy. The code reads various properties and calls methods using the smart pointers provided by the `#import` statement of the code. In addition, the sample code uses the MFC class `CString` and ATL conversion macros such as `W2T`.

The broad steps to create an ATL DLL are as follows:

1. Open VisualStudio and select **File | New**.
2. Select the *Projects* tab.
3. Select *ATL COM AppWizard*, and type in a project name.
4. Select *Support for MFC* if you want to use MFC classes or if you want to create a project for the sample code.

Having created the project files you can add an ATL object to implement the `IXMLSpyPlugIn` interface:

1. Select **Insert | New ATL Object**.
2. Select *Simple Object* from the wizard. and click **Next**.
3. Type in a name for the object.
4. On the *Attributes* tab, select *Custom* for the type of interface and disable *Aggregation*.

These steps produce the skeleton code for the implementation of the IDE plug-in interface. See the following pages for information about how to modify the code and specify some basic functionality.

26.2.4.1 Interface description (IDL)

The IDL of the newly created ATL object contains a declaration for one COM interface.

- This interface declaration must be replaced by the declaration of `IXMLSpyPlugIn` as shown below.
- The IDL must also contain the definition of the `SPYUpdateAction` enumeration.
- Replace the generated default interface name (created by the wizard) with `IXMLSpyPlugIn` in the `coclass` declaration.

The IDL should then look something like the example code below. After creating the ATL object, you need to implement the IDE plug-in interface of XMLSpy.

```
import "oaidl.idl";
import "ocidl.idl";

// ----- please insert the following block into your IDL file -----
typedef enum {
    spyEnable = 1,
    spyDisable = 2,
    spyCheck = 4,
    spyUncheck = 8
} SPYUpdateAction;

// ----- end insert block -----

// ----- E.g. Interface entry automatically generated by the ATL wizard -----
// [
//     object,
//     uuid(AB7CD86A-8145-429A-A1F3-270692E08AFC),

//     helpstring("IXMLSpyPlugIn Interface")
//     pointer_default(unique)
// ]
// interface IXMLSpyPlugIn : IUnknown
// {
// };
// ----- end automatically generated Interface Entry

// ----- replace the Interface Entry (shown above) generated for you by the ATL wizard,
// with the following block -----

[
    odl,
    uuid(88F2A622-4B7E-42CD-8D04-3C0E5389DD85),
    helpstring("IXMLSpyPlugIn Interface")
]
interface IXMLSpyPlugIn : IUnknown
{
    HRESULT STDMETHODCALLTYPE OnCommand([in] long nID, [in] IDispatch* pXMLSpy);
};
```



```

        HRESULT _stdcall OnUpdateCommand([in] long nID, [in] IDispatch* pXMLSpy, [out,
retval] SPYUpdateAction* pAction);
        HRESULT _stdcall OnEvent([in] long nEventID, [in] SAFEARRAY(VARIANT)*
arrayParameters, [in] IDispatch* pXMLSpy, [out, retval] VARIANT* pReturnValue);
        HRESULT _stdcall GetUIModifications([out, retval] BSTR* pModificationsXML);
        HRESULT _stdcall GetDescription([out, retval] BSTR* pDescription);
};

```

```
// ----- end replace block -----
```

```
// ----- The code below is automatically generated by the ATL wizard and will look slightly
different in your case -----
```

```

[
    uuid(24FE0D1B-3FC0-494E-B36E-1D4CE412B014),
    version(1.0),
    helpstring("XMLSpyIDEPlugInDLL 1.0 Type Library")
]
library XMLSPYIDEPLUGINDLLLib
{
    importlib("stdole32.tlb");
    importlib("stdole2.tlb");

    [
        uuid(3800E791-7F6B-4ACD-9E32-2AC184444501),
        helpstring("XMLSpyIDEPlugIn Class")
    ]
    coclass XMLSpyIDEPlugIn
    {
        [default] interface IXMLSpyPlugIn; // ----- define IXMLSpyPlugIn as the default
interface -----
    };
};

```

26.2.4.2 Class definition

In the class definition of the ATL object, the following changes must be made:

- The class has to derive from IXMLSpyPlugIn
- The "Interface Map" needs an entry for IXMLSpyPlugIn
- The methods of the IDE plug-in interface must be declared

These changes can be made as shown below:

```

#ifdef __XMLSPYIDEPLUGIN_H_
#define __XMLSPYIDEPLUGIN_H_

#include "resource.h" // main symbols

////////////////////////////////////
// CXMLSpyIDEPlugIn

```

```

class ATL_NO_VTABLE CXMLSpyIDEPlugIn :
public CComObjectRootEx<CComSingleThreadModel>,
public CComCoClass<CXMLSpyIDEPlugIn, &CLSID_XMLSpyIDEPlugIn>,
public IXMLSpyPlugIn
{
public:
    CXMLSpyIDEPlugIn()
    {
    }

DECLARE_REGISTRY_RESOURCEID(IDR_XMLSPYIDEPLUGIN)
DECLARE_NOT_AGGREGATABLE(CXMLSpyIDEPlugIn)

DECLARE_PROTECT_FINAL_CONSTRUCT()

BEGIN_COM_MAP(CXMLSpyIDEPlugIn)
    COM_INTERFACE_ENTRY(IXMLSpyPlugIn)
END_COM_MAP()

// IXMLSpyIDEPlugIn
public:
    virtual HRESULT _stdcall OnCommand(long nID, IDispatch* pXMLSpy);
    virtual HRESULT _stdcall OnUpdateCommand(long nID, IDispatch* pXMLSpy, SPYUpdateAction*
pAction);
    virtual HRESULT _stdcall OnEvent(long nEventID, SAFEARRAY **arrayParameters, IDispatch*
pXMLSpy, VARIANT* pReturnValue);
    virtual HRESULT _stdcall GetUIModifications(BSTR* pModificationsXML);
    virtual HRESULT _stdcall GetDescription(BSTR* pDescription);
};

#endif // __XMLSPYIDEPLUGIN_H_

```

26.2.4.3 Implementation

The code below shows a simple implementation of an XMLSpy IDE plug-in. It adds a menu item and a separator (available with XMLSpy) to the Tools menu. Inside the OnUpdateCommand() method, the new command is only enabled when the active document is displayed using the Grid View. The command searches for the XML element which has the current focus, and opens any URL starting with "http://", from the textual value of the element.

```

////////////////////////////////////
// CXMLSpyIDEPlugIn

#import "XMLSpy.tlb"
using namespace XMLSpyLib;

HRESULT CXMLSpyIDEPlugIn::OnCommand(long nID, IDispatch* pXMLSpy)
{
    USES_CONVERSION;

    if(nID == 1) {

```

```

IApplicationPtr    ipSpyApp;

if(pXMLSpy) {
    if(SUCCEEDED(pXMLSpy->QueryInterface(__uuidof(IApplication), (void **)&ipSpyApp))
{
    IDocumentPtr  ipDocPtr = ipSpyApp->ActiveDocument;

    // we assume that grid view is active
    if(ipDocPtr) {
        IGridViewPtr  ipGridPtr = ipDocPtr->GridView;

        if(ipGridPtr) {
            IXMLDataPtr  ipXMLData = ipGridPtr->CurrentFocus;

            CString  strValue = W2T(ipXMLData->TextValue);

            if(!strValue.IsEmpty() && (strValue.Left(7) == _T("http://")))
                ::ShellExecute(NULL, _T("open"), W2T(ipXMLData->TextValue), NULL, NULL, SW_SHOWNORMAL);
        }
    }
}

return S_OK;
}

```

```

HRESULT CXMLSpyIDEPlugIn::OnUpdateCommand(long nID, IDispatch* pXMLSpy, SPYUpdateAction*
pAction)
{
    *pAction = spyDisable;

    if(nID == 1) {
        IApplicationPtr    ipSpyApp;

        if(pXMLSpy) {
            if(SUCCEEDED(pXMLSpy->QueryInterface(__uuidof(IApplication), (void **)&ipSpyApp))
        {
            IDocumentPtr  ipDocPtr = ipSpyApp->ActiveDocument;

            // only enable if grid view is active
            if((ipDocPtr != NULL) && (ipDocPtr->CurrentViewMode == spyViewGrid))
                *pAction = spyEnable;
        }
    }
}

return S_OK;
}

```

```

HRESULT CXMLSpyIDEPlugIn::OnEvent(long nEventID, SAFEARRAY **arrayParameters, IDispatch*
pXMLSpy, VARIANT* pReturnValue)
{

```

```

    return S_OK;
}

HRESULT CXMLSpyIDEPlugIn::GetUIModifications(BSTR* pModificationsXML)
{
    CComBSTR bstrMods = _T(" \
        <ConfigurationData> \
            <Modifications> ");
    // add "Open URL..." to Tools menu
    bstrMods.Append (_T(" \
        <Modification> \
            <Action>Add</Action> \
            <UIElement type=\"MenuItem\"> \
                <ID>1</ID> \
                <Name>Open URL...</Name> \
                <Place>0</Place> \
                <MenuID>129</MenuID> \
                <Parent>:Tools</Parent> \
            </UIElement> \
        </Modification> "));
    // add Seperator to Tools menu
    bstrMods.Append (_T(" \
        <Modification> \
            <Action>Add</Action> \
            <UIElement type=\"MenuItem\"> \
                <ID>0</ID> \
                <Place>1</Place> \
                <MenuID>129</MenuID> \
                <Parent>:Tools</Parent> \
            </UIElement> \
        </Modification> "));
    // finish modification description
    bstrMods.Append (_T(" \
        </Modifications> \
        </ConfigurationData>"));

    return bstrMods.CopyTo(pModificationsXML);
}

HRESULT CXMLSpyIDEPlugIn::GetDescription(BSTR* pDescription)
{
    CComBSTR bstrDescr = _T("ATL C++ XMLSpy IDE PlugIn;This PlugIn demonstrates the
implementation of a simple ATL DLL as a IDE PlugIn for XMLSpy.");
    return bstrDescr.CopyTo(pDescription);
}

```

26.2.5 IXMLSpyPlugIn

Methods

[OnCommand](#) ¹¹²⁹

[OnUpdateCommand](#) ¹¹³⁰

[OnEvent](#) ¹¹³¹

[GetUIModifications](#) ¹¹³²

[GetDescription](#) ¹¹³³**Description**

If a DLL is added to XMLSpy as an IDE plug-in, it is necessary that it registers a COM component that answers to an `IXMLSpyPlugIn` interface with the reserved `uuid(88F2A622-4B7E-42CD-8D04-3C0E5389DD85)`. This is required for it to be recognized as a plug-in.

26.2.5.1 OnCommand

Declaration

```
OnCommand(nID as long, pXMLSpy as IDispatch)
```

Description

The `OnCommand()` method of the interface implementation is called each time a command added by the IDE plug-in (menu item or toolbar button) is processed. `nID` stores the command ID defined by the `ID` element of the respective `UIElement`. `pXMLSpy` holds a reference to the dispatch interface of the `Application` object of XMLSpy.

Example

```
Public Sub IXMLSpyPlugIn_OnCommand(ByVal nID As Long, ByVal pXMLSpy As Object)
    If (Not (pXMLSpy Is Nothing)) Then
        Dim objDlg
        Dim objDoc As XMLSpyLib.Document
        Dim objSpy As XMLSpyLib.Application
        Set objSpy = pXMLSpy

        If nID = 3 Or nID = 5 Then
            Set objDlg = CreateObject("MSComDlg.CommonDialog")
            objDlg.Filter = "XML Files (*.xml)|*.xml|All Files (*.*)|*.*||"
            objDlg.FilterIndex = 1
            objDlg.ShowOpen

            If Len(objDlg.FileName) > 0 Then
                Set objDoc = objSpy.Documents.OpenFile(objDlg.FileName, False)
                Set objDoc = Nothing
            End If
        End If

        If nID = 4 Or nID = 6 Then
            Set objDlg = CreateObject("MSComDlg.CommonDialog")
            objDlg.Filter = "All Files (*.*)|*.*||"
            objDlg.Flags = cdlOFNPathMustExist
            objDlg.ShowSave

            If Len(objDlg.FileName) > 0 Then
                Set objDoc = objSpy.ActiveDocument

                If Not (objDoc Is Nothing) Then
                    objDoc.SetPathName objDlg.FileName
                    objDoc.Save
                    Set objDoc = Nothing
                End If
            End If
        End If
    End If
End Sub
```

```

        End If
    End If
End If

    Set objSpy = Nothing
End If
End Sub

```

26.2.5.2 OnUpdateCommand

Declaration

OnUpdateCommand(nID as long, pXMLSpy as IDispatch) as SPYUpdateAction

Description

The `OnUpdateCommand()` method is called each time the visible state of a button or menu item needs to be set. `nID` stores the command ID defined by the `ID` element of the respective `UIElement`. `pXMLSpy` holds a reference to the dispatch interface of the `Application` object.

Possible return values to set the update state are:

```

spyEnable      = 1
spyDisable     = 2
spyCheck       = 4
spyUncheck     = 8

```

Example

```

Public Function IXMLSpyPlugIn_OnUpdateCommand(ByVal nID As Long, ByVal pXMLSpy As Object)
As SPYUpdateAction
    IXMLSpyPlugIn_OnUpdateCommand = spyDisable

    If (Not (pXMLSpy Is Nothing)) Then
        Dim objSpy As XMLSpyLib.Application
        Set objSpy = pXMLSpy

        If nID = 3 Or nID = 5 Then
            IXMLSpyPlugIn_OnUpdateCommand = spyEnable
        End If
        If nID = 4 Or nID = 6 Then
            If objSpy.Documents.Count > 0 Then
                IXMLSpyPlugIn_OnUpdateCommand = spyEnable
            Else
                IXMLSpyPlugIn_OnUpdateCommand = spyDisable
            End If
        End If
    End If
End Function

```

26.2.5.3 OnEvent

Declaration

OnEvent(nEventID as long, arrayParameters as SAFEARRAY(VARIANT), pXMLSpy as IDispatch) as VARIANT

Description

OnEvent () is called each time an event is raised from XMLSpy.

Possible values for nEventID are:

| | |
|----------------------------|------|
| On_BeforeStartEditing | = 1 |
| On_EditingFinished | = 2 |
| On_FocusChanged | = 3 |
| On_Beforedrag | = 4 |
| On_BeforeDrop | = 5 |
| On_OpenProject | = 6 |
| On_OpenDocument | = 7 |
| On_CloseDocument | = 8 |
| On_SaveDocument | = 9 |
| On_DocEditDragOver | = 10 |
| On_DocEditDrop | = 11 |
| On_DocEditKeyDown | = 12 |
| On_DocEditKeyUp | = 13 |
| On_DocEditKeyPressed | = 14 |
| On_DocEditMouseMove | = 15 |
| On_DocEditButtonUp | = 16 |
| On_DocEditButtonDown | = 17 |
| On_DocEditContextMenu | = 18 |
| On_DocEditPaste | = 19 |
| On_DocEditCut | = 20 |
| On_DocEditCopy | = 21 |
| On_DocEditClear | = 22 |
| On_DocEditSelectionChanged | = 23 |
| On_DocEditDragOver | = 10 |
| On_BeforeOpenProject | = 25 |
| On_BeforeOpenDocument | = 26 |
| On_BeforeSaveDocument | = 27 |
| On_BeforeCloseDocument | = 28 |
| On_ViewActivation | = 29 |

| | |
|--|------|
| <code>On_DocEditKeyboardEvent</code> | = 30 |
| <code>On_DocEditMouseEvent</code> | = 31 |
| <code>On_BeforeValidate</code> | = 32 |
| <code>On_BeforeShowSuggestions</code> | = 33 |
| <code>On_ProjectOpened</code> | = 34 |
| <code>On_Char</code> | = 35 |
| <code>On_Initialize</code> | = 36 |
| <code>On_Running</code> | = 37 |
| <code>On_Shutdown</code> | = 38 |
| <code>On_AuthenticBeforeSave</code> | = 39 |
| <code>On_AuthenticContextMenuActivated</code> | = 40 |
| <code>On_AuthenticLoad</code> | = 41 |
| <code>On_AuthenticToolBarButtonClicked</code> | = 42 |
| <code>On_AuthenticToolBarButtonExecuted</code> | = 43 |
| <code>On_AuthenticUserAddedXMLNode</code> | = 44 |

The names of the events are the same as they appear in the Scripting Environment of XMLSpy. For IDE plug-ins the names used are immaterial. The events are identified using the ID value.

`arrayParameters` is an array which is filled with the parameters of the currently raised event. Order, type, and meaning of the single parameters are available through the scripting environment of XMLSpy. The events module of a scripting project contains predefined functions for all events prior to version 4.4. The parameters passed to the predefined functions are identical to the array elements of the `arrayParameters` parameter.

Events raised from the Authentic View of XMLSpy do not pass any parameters directly. An "event" object is used instead. The event object can be accessed through the `Document` object of the active document.

`pXMLSpy` holds a reference to the dispatch interface of the `Application` object of XMLSpy.

If the return value of `OnEvent()` is set, then neither the IDE plug-in nor an event handler inside of the scripting environment will get this event afterwards. Please note that all IDE plug-ins get/process the event before the Scripting Environment does.

26.2.5.4 GetUIModifications

Declaration

```
GetUIModifications() as String
```

Description

The `GetUIModifications()` method is called during initialization of the plug-in, to get the configuration XML data that defines the changes to the UI of XMLSpy. The method is called when the plug-in is loaded for the first time, and at every start of XMLSpy. See also [Configuration XML](#)¹¹²⁰ for a detailed description how to change the UI.

Example

```
Public Function IXMLSpyPlugIn_GetUIModifications() As String
    ' GetUIModifications() gets the XML file with the specified modifications of
    ' the UI from the config.xml file in the plug-in folder
    Dim strPath As String
    strPath = App.Path

    If Len(strPath) > 0 Then
        Dim fso As New FileSystemObject
        Dim file As file
        Set file = fso.GetFile(strPath & "\config.xml")

        If (Not (file Is Nothing)) Then
            Dim stream As TextStream
            Set stream = file.OpenAsTextStream(ForReading)

            ' this replaces the token '**path**' from the XML file with
            ' the actual installation path of the plug-in to get the image file
            Dim strMods As String
            strMods = stream.ReadAll
            strMods = Replace(strMods, "**path**", strPath)

            IXMLSpyPlugIn_GetUIModifications = strMods
        Else
            IXMLSpyPlugIn_GetUIModifications = ""
        End If
    End If
End Function
```

26.2.5.5 GetDescription

Declaration

```
GetDescription() as String
```

Description

GetDescription() is used to define the description string for the plug-in entries visible in the Customize dialog box.

Example

```
Public Function IXMLSpyPlugIn_GetDescription() As String
    IXMLSpyPlugIn_GetDescription = "Sample Plug-in for XMLSpy;This Plug-in demonstrates the
    implementation of a simple VisualBasic DLL as a Plug-in for XMLSpy."
End Function
```

26.3 Application API

The COM-based API of XMLSpy (also called the Application API from now on) enables other applications to use the functionality of XMLSpy. As a result, it is possible to automate a wide range of tasks, from validating an XML file to modifying complex XML content (with the [XMLData](#)¹³⁷³ interface).

XMLSpy and its Application API follow the common specifications for automation servers set out by Microsoft. It is possible to access the methods and properties of the Application API from common development environments, such as those using C#, C++, VisualBasic, and Delphi, and with scripting languages like JScript and VBScript.

Execution environments for the Application API

The Application API can be accessed from the following execution environments:

- External programs (described [below](#)¹¹³⁴ and in the [Overview](#)¹¹³⁵ part of this section)
- From within the built-in Scripting Editor of XMLSpy. For a description of the scripting environment, see the section, [Scripting Editor](#)¹⁰⁹².
- XMLSpy allows you to create and integrate your own plug-ins into the application using a special interface for plug-ins. A description of how to create plug-ins is given in the section [IDE Plug-ins](#)¹¹¹⁹.
- Via an ActiveX Control, which is available if the [integration package](#)¹⁴⁸⁰ is installed. For more information, see the section [ActiveX Integration](#)¹⁴⁸⁰.

External programs

In the [Overview](#)¹¹³⁵ part of this section, we describe how the functionality of XMLSpy can be accessed and automated from external programs.

Using the Application API from outside XMLSpy requires an instance of XMLSpy to be started first. How this is done depends on the programming language used. See the section, [Programming Languages](#)¹¹³⁶, for information about individual languages.

Essentially, XMLSpy will be started via its COM registration. Then the `Application` object associated with the XMLSpy instance is returned. Depending on the COM settings, an object associated with an already running XMLSpy can be returned. Any programming language that supports creation and invocation of COM objects can be used. The most common of these are listed below.

- JScript and [VBScript](#)¹¹⁴⁶ script files have a simple syntax and are designed to access COM objects. They can be run directly from a DOS command line or with a double click on Windows Explorer. They are best used for simple automation tasks.
- [C#](#)¹¹⁴⁹ is a full-fledged programming language that has a wide range of existing functionality. Access to COM objects can be automatically wrapped using `C#`.
- C++ provides direct control over COM access but requires relatively larger amounts of code than the other languages.
- [Java](#)¹¹⁵⁹: Altova products come with native Java classes that wrap the Application API and provide a full Java look-and-feel.
- Other programming languages that make useful alternatives are: Visual Basic for Applications, Perl, and Python.

Programming points

The following limitations must be considered in your client code:

- Be aware that if your client code crashes, instances of XMLSpy may still remain in the system.
- Don't hold references to objects in memory longer than you need them, especially those from the `XMLData` interface. If the user interacts between two calls of your client, then there is no guarantee that these references are still valid.
- Don't forget to disable dialogs if the user interface is not visible.
- See [Error handling in JScript](#)¹¹⁴¹ (and in [C#](#)¹¹⁵⁷ and [Java](#)¹¹⁶⁵) for details of how to avoid annoying error messages.
- Free references explicitly if you are using C# or C++.

This documentation

This documentation section about the Application API is broadly divided into two parts.

- The first part consists of an [Overview](#)¹¹³⁵, which describes the object model for the API and explains how the API is accessed via various [programming languages](#)¹¹³⁶.
- The second part is a reference section ([Interfaces](#)¹¹⁷¹ and [Enumerations](#)¹⁴²²) that contains descriptions of the interface objects of the Application API.

26.3.1 Overview

This overview of the Application API is organized as follows:

- [The Object Model](#)¹¹³⁵ describes the relationships between the objects of the Application API.
- [Programming Languages](#)¹¹³⁶ explains how the most commonly used programming languages (JScript, VBScript, C#, and Java) can be used to access the functionality of the Application API. Code listings from the example files supplied with your application package are used to describe basic mechanisms.
- [The DOM and XMLData](#)¹¹⁶⁷ explains the relationship between the Application API's XMLData interface and the DOM.
- [Obsolete: Authentic View Row Operations](#)¹¹⁷⁰ supplies information about obsolete objects for Authentic View table row operations.
- [Obsolete: Authentic View Editing Operations](#)¹¹⁷⁰ supplies information about obsolete objects for Authentic View editing operations.

26.3.1.1 Object Model

The starting point for every application which uses the Application API is the [Application](#)¹¹⁷² object. This object contains general methods like import/export support and references to the open documents and any open project.

The `Application` object is created differently in various programming languages. In scripting languages such as JScript or VBScript, this involves calling a function which initializes the application's COM object. For examples, see the [Programming Languages](#)¹¹³⁶ section.

Broad structure of the object model

The picture below shows the links between the main objects of the Application API:

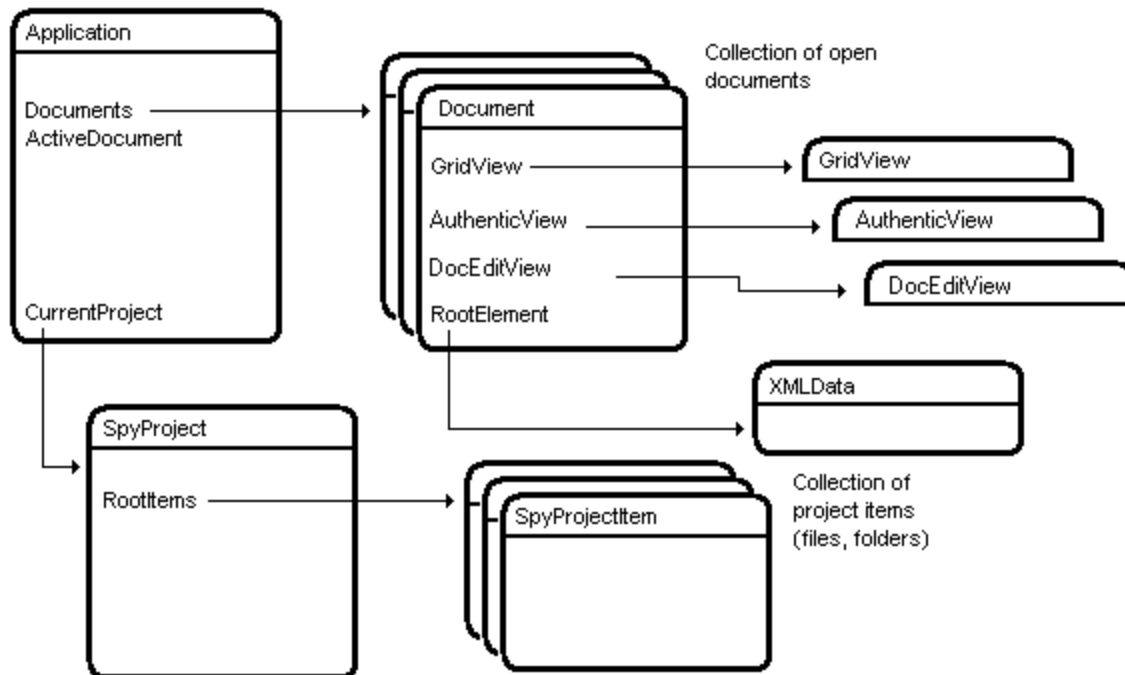

The `Application` object consists of the following parts:

- Document collection and reference to the active document.
- Reference to current project and methods for creating and opening projects.
- Methods to support the export to and import from databases, text files, and Word documents.
- URL management.
- Methods for macro menu items.

Once you have created an `Application` object you can start using the functionality of `XMLSpy`. In most cases, you either open a project and access the documents from there or you directly open a document via the [Documents](#) ¹²³⁶ interface.

26.3.1.2 Programming Languages

Programming languages differ in the way they support COM access. A few examples for the most frequently used languages (*links below*) will help you get started. The code listings in this section show how basic functionality can be accessed. The files in the `API` subfolder of the `Examples` folder can be used to test this functionality:

| | |
|---|--|
| Windows 7, Windows 8,
Windows 10, Windows 11 | C:\Users\ <username>\Documents\
Altova\XMLSpy\2024\Examples</username> |
|---|--|

JScript

The JScript listings demonstrate the following basic functionality:

- [Start application or attach to a running instance](#) ¹¹³⁸
- [Simple document access](#) ¹¹³⁹
- [Iteration](#) ¹¹⁴⁰
- [Error handling](#) ¹¹⁴¹
- [Events](#) ¹¹⁴¹
- [Import and export of data](#) ¹¹⁴²

VBScript

VBScript is different than JScript only syntactically; otherwise it works in the same way. The link below goes to an example of how VBScript can be used. For more information, refer to the [JScript examples](#) ¹¹³⁸.

- [Events](#) ¹¹⁴⁶: Shows how events are handled using VBScript.

C#

C# can be used to access the Application API functionality. The code listings show how to access the API for certain basic functionality.

- [Start XMLSpy](#) ¹¹⁵⁴: Starts XMLSpy, which is registered as an automation server, or activates the program if XMLSpy is already running.
- [Open OrgChart.pxf](#) ¹¹⁵⁵: Locates one of the example documents installed with XMLSpy and opens it. If this document is already open it becomes the active document.
- [OnDocumentOpened Event On/Off](#) ¹¹⁵⁸: Shows how to listen to XMLSpy events. When turned on, a message box will pop up after a document has been opened.
- [Open ExpReport.xml](#) ¹¹⁵⁵: Opens another example document.
- [Toggle View Mode](#) ¹¹⁵⁶: Changes the view of all open documents between Text View and Authentic View. The code shows how to iterate through open documents.
- [Validate](#) ¹¹⁵⁷: Validates the active document and shows the result in a message box. The code shows how to handle errors and COM output parameters.
- [Shutdown XMLSpy](#) ¹¹⁵⁴: Stops XMLSpy.

Java

The XMLSpy API can be accessed from Java code. [The Java sub-section of this section](#) ¹¹⁵⁹ explains how some basic XMLSpy functionality can be accessed from Java code. It is organized into the following sub-sections:

- [Mapping Rules for the Java Wrapper](#) ¹¹⁵⁹
- [Example Java Project](#) ¹¹⁶⁰
- [Application Startup and Shutdown](#) ¹¹⁶⁴
- [Simple Document Access](#) ¹¹⁶⁵
- [Iterations](#) ¹¹⁶⁵
- [Use of Out-Parameters](#) ¹¹⁶⁵
- [Event Handlers](#) ¹¹⁶⁶

26.3.1.2.1 JScript

This section contains listings of JScript code that demonstrate the following basic functionality:

- [Start application or attach to a running instance](#) ¹¹³⁸
- [Simple document access](#) ¹¹³⁹
- [Iteration](#) ¹¹⁴⁰
- [Error handling](#) ¹¹⁴¹
- [Events](#) ¹¹⁴¹
- [Import and export of data](#) ¹¹⁴²

Example files

The code listings in this section are available in example files that you can test as is or modify to suit your needs. The JScript example files are located in the `JScript` subfolder of the API Examples folder:

| | |
|---|--|
| Windows 7, Windows 8,
Windows 10, Windows 11 | C:\Users\<<username>\Documents\
Altova\XMLSpy\2024\Examples |
|---|--|

The example files can be run in one of two ways:

- *From the command line:* Open a command prompt window, change the directory to the path above, and type the name of one of the example scripts (for example, `Start.js`).
- *From Windows Explorer:* In Windows Explorer, browse for the JScript file and double-click it.

The script is executed by Windows Script Host that is packaged with Windows operating system. For more information about Windows Script Host, refer to MSDN documentation (<https://msdn.microsoft.com>).

26.3.1.2.1.1 Start Application

The JScript below starts the application and shuts it down. If the COM object of the 32-bit XMLSpy cannot be found, the code attempts to get the COM object of the 64-bit application; otherwise, an error is thrown. If an instance of the application is already running, the running instance will be returned.

Note: For 32-bit XMLSpy, the registered name, or programmatic identifier (ProgId) of the COM object is `XMLSpy.Application`. For 64-bit XMLSpy, the name is `XMLSpy_x64.Application`. Be aware, though, that the calling program will access the CLASSES registry entries in its own registry hive, or group (32-bit or 64-bit). Therefore, if you run scripts using the standard command prompt and Windows Explorer on 64-bit Windows, the 64-bit registry entries will be accessed, which point to the 64-bit XMLSpy. For this reason, if both XMLSpy 32-bit and 64-bit are installed, special handling is required in order to call the 32-bit XMLSpy. For example, assuming that Windows Scripting Host is the calling program, do the following:

1. Change the current directory to **C:\Windows\SysWOW64**.
2. At the command line, type **wscript.exe** followed by the path to the script that you would like to run, for example:

```
wscript.exe "C:\Users\...\Documents\Altova\StyleVision2024\StyleVisionExamples\API\JScript\start.js"wscript.exe "C:\Users\...\Documents\Altova\XMLSpy2024\Examples\API\JScript\start.js"
```

```
// Initialize application's COM object. This will start a new instance of the application and
// return its main COM object. Depending on COM settings, the main COM object of an already
// running application might be returned.

try {   objSpy = WScript.GetObject("", "XMLSpy.Application");   }
catch(err) {}

if( typeof( objSpy ) == "undefined" )
{
    try   {   objSpy = WScript.GetObject("", "XMLSpy_x64.Application")   }
    catch(err)
    {
        WScript.Echo( "Can't access or create XMLSpy.Application" );
        WScript.Quit();
    }
}

// if newly started, the application will start without its UI visible. Set it to visible.
objSpy.Visible = true;

WScript.Echo(objSpy.Edition + " has successfully started. ");

objSpy.Visible = false;           // will shutdown application if it has no more COM
connections
//objSpy.Visible = true;         // will keep application running with UI visible
```

The JScript code listed above is available in the sample file `Start.js` (see [Example Files](#)¹¹³⁹).

26.3.1.2.1.2 Simple Document Access

After you have started the application as shown in [Start Application](#)¹¹³⁹, you will most likely want to programmatically open a document in order to work with it. The JScript code listing below illustrates how to open two documents from the XMLSpy Examples folder and set one of them as the active document.

```
// Locate examples via USERPROFILE shell variable. The path needs to be adapted to major
release versions.
objWshShell = WScript.CreateObject("WScript.Shell");
majorVersionYear = objSpy.MajorVersion + 1998
strExampleFolder = objWshShell.ExpandEnvironmentStrings("%USERPROFILE%") + "\\My
Documents\\Altova\\XMLSpy" + majorVersionYear + "\\Examples\\";
```

```

// Tell XMLSpy to open two documents. No dialogs
objDoc1 = objSpy.Documents.OpenFile(strExampleFolder + "OrgChart.pxf", false);
objSpy.Documents.OpenFile(strExampleFolder + "ExpReport.xml", false);

// The document currently active can be easily located.
objDoc2 = objSpy.ActiveDocument;

// Let us make sure that the document is shown in grid view.
objDoc2.SwitchViewMode(0); // SPYViewModes.spyViewGrid = 0

// Now switch back to the document opened first
objDoc1.SetActiveDocument();

```

The JScript code listed above is available in the sample file `DocumentAccess.js` (see [Example Files](#)¹¹³⁸).

26.3.1.2.1.3 Iteration

The JScript listing below shows how to iterate through the open documents. It is assumed that you have already started the application and opened some documents as shown in the previous sections.

```

// go through all open documents using a JScript Enumerator
bRequiresSaving = false;
for (var iterDocs = new Enumerator(objSpy.Documents); !iterDocs.atEnd());
iterDocs.moveNext()
{
    if (iterDocs.item().IsModified)
        bRequiresSaving = true;

    var strErrorText = new Array(1);
    var nErrorNumber = new Array(1);
    var errorData = new Array(1);

    if (!iterDocs.item().IsValid(strErrorText, nErrorNumber, errorData))
    {
        var text = strErrorText;
        // access that XMLData object only if filled in
        if (errorData[0] != null)
            text += "(" + errorData[0].Name + "/" + errorData[0].TextValue + ")";

        WScript.Echo("Document \"" + iterDocs.item().Name + "\" validation error[" +
nErrorNumber + "]: " + text);
    }
    else
    {
        // The COM call succeeded and the document is valid.
        WScript.Echo("Document \"" + iterDocs.item().Name + "\" is valid.");
    }
}

```



```
// go through all open documents using index-based access to the document collection
for (i = objSpy.Documents.Count; i > 0; i--)
    objSpy.Documents.Item(i).Close(false);
```

The JScript code listed above is available in the sample file `DocumentAccess.js` (see [Example Files](#) ¹¹³⁸).

26.3.1.2.1.4 Error Handling

The Application API returns errors in two different ways:

- The `HRESULT` returned by every API method
- The `IErrorInfo` interface of the Application API

Every API method returns an `HRESULT`. This return value gives the caller information about errors during execution of the method. If the call was successful, the return value is `S_OK`. The `HRESULT` option is commonly used in C/C++ programs.

However, programming languages such as VisualBasic and scripting languages (and other high-level development environments) don't give the programmer access to the `HRESULT` return of a COM call. Such languages use the `IErrorInfo` interface, which is also supported by the Application API. If an error occurs, the Application API creates a new object that implements the `IErrorInfo` interface. The information provided by the `IErrorInfo` interface is imported by the development environment into its own error-handling mechanism.

For example, the JScript code listing below causes an error to be thrown by incorrectly declaring an array. Additional information about the error object is provided by its properties `number` and `description`.

```
try {
    var arr = new Array(-1);
}
catch (err) {
    WScript.Echo("Error : (" + (err.number & 0xffff) + ") " + err.description);
}
```

26.3.1.2.1.5 Events

COM specifies that a client must register itself at a server for callbacks using the connection point mechanism. The automation interface for XMLSpy defines the necessary event interfaces. The way to connect to those events depends on the programming language you use in your client. The following code listing shows how this is done using JScript.

The method `WScript.ConnectObject` is used to receive events.

```
// The event-handler function
function DocEvent_OnBeforeCloseDocument(objDocument)
{
```

```

WScript.Echo("Received event - before closing document");
}

// Create or connect to XMLSpy (or Authentic Desktop)
try
{
    // Create the environment and XMLSpy (or Authentic Desktop)
    objWshShell = WScript.CreateObject("WScript.Shell");
    objFSO = WScript.CreateObject("Scripting.FileSystemObject");
    objSpy = WScript.GetObject("", "XMLSpy.Application");

    // If only Authentic Desktop is installed (and XMLSpy is not installed) use:
    // objSpy = WScript.GetObject("", "AuthenticDesktop.Application")

}
catch(err)
    { WScript.Echo ("Can't create WScript.Shell object or XMLSpy"); }

// Create document object and connect to its events
objSpy.Visible = true;
majorVersionYear = objSpy.MajorVersion + 1998
docPath = objWshShell.ExpandEnvironmentStrings("%USERPROFILE%") + "\\Documents\\Altova\\
XMLSpy" + majorVersionYear + "\\Examples\\ExpReport.xml";
objDoc = objSpy.Documents.OpenFile (docPath, false);
WScript.ConnectObject(objDoc, "DocEvent_");

// Keep running while waiting for the event
// In the meanwhile close this document in XMLSpy (or Authentic Desktop) manually
WScript.Echo ("Sleeping for 10 seconds ...");
WScript.Sleep (10000);

objDoc = null;
WScript.Echo ("Stopped listening for event");
objSpy.Quit();

```

26.3.1.2.1.6 *Import and Export of Data*

Before you implement your import and export tasks with the Application API, it is good practice to test the connections, parameters, SQL queries and so on in XMLSpy. In this way you are able to verify the results and make quick adjustments to import or export parameters. Most of the methods for importing and exporting data are placed in the [Application](#)¹¹⁷² object; the remaining functions are accessible via the [Document](#)¹²⁶⁴ interface.

There is some preparatory work necessary before the actual import or export can be started. Every import/export job consists of two parts. You need to define a connection to your data and the specific behavior for the import/export process. In case of an import, the connection is either a database, a text-file, or a Word document. The main issue is which data (columns) to imported into XMLSpy. In case of an export, the connection is either a database or a text file. Specify which data (elements of the XML file) and additional parameters (for example, automatic key generation or number of sub-levels) to use from the XML-structure.

The properties in the `DatabaseConnection`, `TextImportExportSettings` and `ExportSettings` interfaces have default values. See the corresponding descriptions in the [Interfaces](#) ¹¹⁷¹ chapter for further information.

The sub-sections of this section describe each of these operations in detail.

- [Import from Database](#) ¹¹⁴³
- [Export to Database](#) ¹¹⁴⁴
- [Import from Text](#) ¹¹⁴⁴
- [Export to Text](#) ¹¹⁴⁵

Given below are the steps to establish a connection to an existing database for import:

1. Use a [DatabaseConnection](#) ¹²⁵⁴ object and set the following:
 - The method [Application.GetDatabaseSettings](#) ¹¹⁷⁹ returns a new object for a database connection: `objImpSettings = objSpy.GetDatabaseSettings();`
 - You have to set either an ADO connection string, `objImpSettings.ADOConnection = strADOConnection` or the path to an existing database file: `objImpSettings.File = strExampleFolder + "Tutorial\\Company.mdb";`
 - To complete the settings you create an SQL SELECT statement to define the data to be queried: `objImpSettings.SQLSelect = "SELECT * FROM Address";`
2. Call [Application.GetDatabaseImportElementList](#) ¹¹⁷⁹ to get a collection of the resulting columns of the SQL query: `objElementList = objSpy.GetDatabaseImportElementList(objImpSettings);` This collection gives you the opportunity to control which columns should be imported and specify the datatype of the new elements. Each item of the collection represents one column to import. If you remove an item, the corresponding column will not be imported. You can additionally modify the [ElementListItem.ElementKind](#) ¹³⁰⁵ property to set the datatype of the XML elements for each column. Please consider that `GetDatabaseImportElementList()` executes the SQL query and could initiate a time-consuming call. To avoid this, it is possible to pass a null-pointer as the second parameter to `ImportFromDatabase();` this imports all columns as plain XML elements.
3. Start the import with [Application.ImportFromDatabase](#) ¹¹⁸³: `objImpDocFromDB = objSpy.ImportFromDatabase(objImpSettings,objElementList);`

```
// Locate examples via USERPROFILE shell variable.
objWshShell = WScript.CreateObject("WScript.Shell");
majorVersionYear = objSpy.MajorVersion + 1998
strExampleFolder = objWshShell.ExpandEnvironmentStrings("%USERPROFILE%") + "\\My
Documents\\Altova\\XMLSpy" + majorVersionYear + "\\Examples\\";

try
{
    // specify the source of data import
    objImpSettings = objSpy.GetDatabaseSettings();
    objImpSettings.File = strExampleFolder + "Tutorial\\Company.mdb";
    objImpSettings.SQLSelect = "SELECT * FROM Address";

    // column filter
    objElementList = objSpy.GetDatabaseImportElementList(objImpSettings);

    // import into a new XML file
    objImpDocFromDB = objSpy.ImportFromDatabase(objImpSettings,objElementList);
}
catch(err)
```

```

{
    WScript.Echo("Error importing from database.\n\n" +
                "Error: " + (err.number & 0xffff) + "\n" +
                "Description: " + err.description);
}

```

The JScript code listed above is available in the sample file `ImportExport.js` (see [Example Files](#) ¹¹³⁸).

To export data to a database, carry out the steps below:

1. Use a [DatabaseConnection](#) ¹²⁵⁴ object and set the necessary properties. All properties except `SQLSelect` are important for the export. `ADOConnection` or `File` defines the target for the output. You need to set only one of them.
2. Fill an [ExportSettings](#) ¹³⁰⁶ object with the required values. These properties are the same options as those available in the export dialog of XMLSpy. Select the menu option **Convert | Export to Text files/Database** to see the options and try a combination of export settings. After that it is easy to transfer these settings to the properties of the interface. Call [Application.GetExportSettings](#) ¹¹⁸¹ to get an `ExportSettings` object: `objExpSettings = objSpy.GetExportSettings()`
3. Build an element list with [Document.GetExportElementList](#) ¹²⁸³. The element list enables you to eliminate XML elements from the export process. It also gives you information about the record and field count in the `RecordCount` and `FieldCount` properties. Set the [ExportSettings.ElementList](#) ¹³⁰⁶ property to this collection. It is possible to set the element list to `null/Nothing` (default) to export all elements.
4. Call [Document.ExportToDatabase](#) ¹²⁷⁷ to execute the export. The description of the `ExportToDatabase` method contains also a code example for a database export.

```

// set the behaviour of the export with ExportSettings
objExpSettings = objSpy.GetExportSettings()

//set the destination with DatabaseConnection
objDB = objSpy.GetDatabaseSettings();
objDB.CreateMissingTables = true;
objDB.CreateNew = true;
objDB.File = "C:\\Temp\\Export.mdb";

try
{
    objImpDocFromDB.ExportToDatabase(objImpDocFromDB.RootElement, objExpSettings, objDB);
}
catch(err)
{
    WScript.Echo("Error exporting to database.\n\n" +
                "Error: " + (err.number & 0xffff) + "\n" +
                "Description: " + err.description);
}

```

The JScript code listed above is available in the sample file `ImportExport.js` (see [Example Files](#) ¹¹³⁸).

Importing data from a text file is similar to the import from a database. You must use other interfaces (described in steps 1 to 3 below) with different methods and properties:

1. Use a [TextImportExportSettings](#)¹³⁶⁵ object and set the properties: The method [Application.GetTextImportExportSettings](#)¹¹⁸² returns a new object to specify a text file for import: `objImpSettings = objSpy.GetTextImportExportSettings();` You have to set at least the `ImportFile` property to the path of the file for the import. Another important property is `HeaderRow`. Set it to `False` if the text file does not contain a leading line as a header row:
`objImpSettings.ImportFile = strExampleFolder + "Tutorial\\Shapes.txt";`
2. Call [Application.GetTextImportElementList](#)¹¹⁸¹ to get a collection of all columns inside the text file: `objElementList = objSpy.GetTextImportElementList(objImpSettings);`
3. Start the import with [Application.ImportFromText](#)¹¹⁸⁵: `objImpDocFromText = objSpy.ImportFromText(objImpSettings, objElementList);`

```
try
{
    // specify the source of data import
    objImpSettings = objSpy.GetTextImportExportSettings();
    objImpSettings.ImportFile = strExampleFolder + "Tutorial\\Shapes.txt";
    objImpSettings.HeaderRow = false;

    // column filter
    objElementList = objSpy.GetTextImportElementList(objImpSettings);

    // import into a new XML file
    objImpDocFromText = objSpy.ImportFromText(objImpSettings, objElementList);
}
catch(err)
{
    WScript.Echo("Error importing from text file.\n\n" +
        "Error: " + (err.number & 0xffff) + "\n" +
        "Description: " + err.description);
}
```

The JScript code listed above is available in the sample file `ImportExport.js` (see [Example Files](#)¹¹³⁸).

To export data to text, carry out the steps below:

1. Use a [TextImportExportSettings](#)¹³⁶⁵ object and set the necessary properties.
2. Fill an [ExportSettings](#)¹³⁰⁶ object with the required values. See Item 2 in [Export to database](#)¹¹⁴⁴.
3. Build an element list with [Document.GetExportElementList](#)¹²⁸³. See Item 3 in [Export to database](#)¹¹⁴⁴.
4. Call [Document.ExportToText](#)¹²⁷⁸ to execute the export.

```
objExpSettings = objSpy.GetExportSettings();
objExpSettings.ElementList =
objImpDocFromText.GetExportElementList(objImpDocFromText.RootElement, objExpSettings);

objTextExp = objSpy.GetTextImportExportSettings();
objTextExp.HeaderRow = true;
objTextExp.DestinationFolder = "C:\\Temp";
```

```

try
{
    objImpDocFromText.ExportToText(objImpDocFromText.RootElement, objExpSettings,
objTextExp);
}
catch(err)
{
    WScript.Echo("Error exporting to text.\n\n" +
                "Error: " + (err.number & 0xffff) + "\n" +
                "Description: " + err.description);
}

```

The JScript code listed above is available in the sample file `ImportExport.js` (see [Example Files](#)¹¹³⁸).

26.3.1.2.2 VBScript

VBScript is syntactically different than JScript but works in the same way. This section contains a listing showing [how events are used with VBScript](#)¹¹⁴⁶ and an [example](#)¹¹⁴⁸.

For information about other functionality, refer to the JScript examples listed below:

- [Start application or attach to a running instance](#)¹¹³⁸
- [Simple document access](#)¹¹³⁸
- [Iteration](#)¹¹⁴⁰
- [Error handling](#)¹¹⁴¹
- [Import and export of data](#)¹¹⁴²

26.3.1.2.2.1 Events

COM specifies that a client must register itself at a server for callbacks using the connection point mechanism. The automation interface for XMLSpy defines the necessary event interfaces. The way to connect to those events depends on the programming language you use in your client. The following code listing shows how this is done using VBScript.

The method `WScript.ConnectObject` is used to receive events.

To run this code, paste it into a file with `.vbs` extension, and either double-click in Windows Explorer, or run it from a command prompt.

```

' the event handler function
Function DocEvent_OnBeforeCloseDocument(objDocument)
    Call WScript.Echo("received event - before closing document")
End Function

' create or connect to XmlSpy

```

```

Set objWshShell = WScript.CreateObject("WScript.Shell")
Set objFSO = WScript.CreateObject("Scripting.FileSystemObject")
Set objSpy = WScript.GetObject("", "XMLSpy.Application")
' If only Authentic is installed (and XMLSpy is not installed) use:
' Set objSpy = WScript.GetObject("", "AuthenticDesktop.Application")
' If only XMLSpy 64-bit is installed, use:
' Set objSpy = WScript.GetObject("", "XMLSpy_x64.Application")

' create document object and connect to its events
objSpy.Visible = True

' Find out user's personal folder and locate one of the installed examples.
personalFolder = objWshShell.ExpandEnvironmentStrings("%UserProfile%")
majorVersionYear = objSpy.MajorVersion + 1998
xmlspyExamplesFolder = personalFolder & "\Documents\Altova\XMLSpy" & majorVersionYear &
"\Examples\"
docPath = xmlspyExamplesFolder & "ExpReport.xml"

' open a document
Set objDoc = objSpy.Documents.OpenFile (docPath, False)
Call WScript.ConnectObject(objDoc, "DocEvent_")

' keep running while waiting on the event
' in the meantime close the document in XMLSPY manually
Call WScript.Echo ("sleeping for 10 seconds ...")
Call WScript.Sleep (10000)

Set objDoc = Nothing
Call WScript.Echo ("stopped listening for event")
Call objSpy.Quit

```

Note: For 32-bit XMLSpy, the registered name, or programmatic identifier (ProgId) of the COM object is XMLSpy.Application. For 64-bit XMLSpy, the name is XMLSpy_x64.Application. Be aware, though, that the calling program will access the CLASSES registry entries in its own registry hive, or group (32-bit or 64-bit). Therefore, if you run scripts using the standard command prompt and Windows Explorer on 64-bit Windows, the 64-bit registry entries will be accessed, which point to the 64-bit XMLSpy. For this reason, if both XMLSpy 32-bit and 64-bit are installed, special handling is required in order to call the 32-bit XMLSpy. For example, assuming that Windows Scripting Host is the calling program, do the following:

1. Change the current directory to **C:\Windows\SysWOW64**.
2. At the command line, type **wscript.exe** followed by the path to the script that you would like to run, for example:

```

wscript.exe "C:\Users\...
\Documents\Altova\StyleVision2024\StyleVisionExamples\API\JScript\start.js"wscript.exe
"C:\Users\...\Documents\Altova\XMLSpy2024\Examples\API\JScript\start.js"

```

26.3.1.2.2.2 Example: Using Events

Authentic View supports event connection on a per-object basis. Implementation of this feature is based on COM connection points and is available in environments that support this mechanism.

The following example is a VBScript code example that shows how to use events from within a VBScript project.

```
' -----
' VBScript example that demonstrates how to use events.
' -----

' Event handler for OnSelectionChanged event of AuthenticView
Function AuthenticViewEvent_OnSelectionChanged(objAuthenticRange)
    If objAuthenticRange.FirstTextPosition <> objAuthenticRange.LastTextPosition Then
        Call WScript.Echo("Selection: " & objAuthenticRange.Text & vbNewLine & vbNewLine
& "Close this dialog.")
    Else
        Call WScript.Echo("Cursor position: " & objAuthenticRange.FirstTextPosition &
vbNewLine & vbNewLine & "Close this dialog.")
    End If
End Function

' Start/access XMLSpy and connect to its automation interface.
Set WshShell = WScript.CreateObject("WScript.Shell")
Set objSpy = GetObject("", "XMLSpy.Application")
' Make the UI of XMLSpy visible.
objSpy.Visible = True

' Find out user's personal folder and locate one of the installed XMLSpy examples.
personalFolder = WshShell.ExpandEnvironmentStrings("%UserProfile%")
majorVersionYear = objSpy.MajorVersion + 1998
xmlspyExamplesFolder = personalFolder & "\Documents\Altova\XMLSpy" & majorVersionYear &
"\Examples\"
docPath = xmlspyExamplesFolder & "ExpReport.xml"

' Create object to access windows file system and test if the our document exists.
Set fso = CreateObject("Scripting.FileSystemObject")
If fso.FileExists(docPath) Then
    ' open the document
    Call objSpy.Documents.OpenFile(docPath, False)
    set objDoc = objSpy.ActiveDocument

    ' switch active document to authentic view
    objDoc.SwitchViewMode 4 ' spyViewAuthentic

    ' Register for connection point events on the authentic view of the active document.
    ' Any function with a valid event name prefixed with "AuthenticViewEvent_" will
    ' be called when the corresponding event gets triggered on the specified object.
    set objView = objDoc.AuthenticView
    Call WScript.ConnectObject(objView, "AuthenticViewEvent_")
    Call WScript.Echo("Events are connected." & vbNewLine & vbNewLine & "Now set or move
```



```

the cursor in XMLSpy." & vbNewLine & vbNewLine & "Close this dialog to shut down
XMLSpy.")

    ' To disconnect from the events delete the reference to the object.
    set objView = Nothing
Else
    Call WScript.Echo("The file " & docPath & " does not exist.")
End If

' shut down XMLSpy when this script ends
objSpy.Visible = False
    
```

26.3.1.2.3 C#

The C# programming language can be used to access the Application API functionality. You could use Visual Studio 2012/2013/2015/2017/2019/2022 to create the C# code, saving it in a Visual Studio project. Create the project as follows:

1. In Microsoft Visual Studio, add a new project using **File | New | Project**.
2. Add a reference to the XMLSpy Type Library by clicking **Project | Add Reference**. The Add Reference dialog appears. Browse for the XMLSpy Type Library component, which is located in the XMLSpy application folder, and add it.
3. Enter the code you want.
4. Compile the code and run it.

Example C# project

Your XMLSpy package contains an example C# project, which is located in the `API\C#` subfolder of the `Examples` folder :

| | |
|---|--|
| Windows 7, Windows 8,
Windows 10, Windows 11 | C:\Users\ <username>\Documents\
Altova\XMLSpy\2024\Examples</username> |
|---|--|

You can compile and run the project from within Visual Studio 2012/2013/2015/2017/2019/2022. The code listing below shows how basic application functionality can be used. This code is similar to the example C# project in the API Examples folder of your application package, but might differ slightly.

Platform configuration

If you have a 64-bit operating system and are using a 32-bit installation of XMLSpy, you must add the x86 platform in the solution's Configuration Manager and build the sample using this configuration. A new x86 platform (for the active solution in Visual Studio) can be created in the New Solution Platform dialog (**Build | Configuration Manager | Active solution platform | <New...>**).

What the code listing below does

The example code listing below creates a simple user interface (*screenshot below*) with buttons that invoke basic XMLSpy operations:

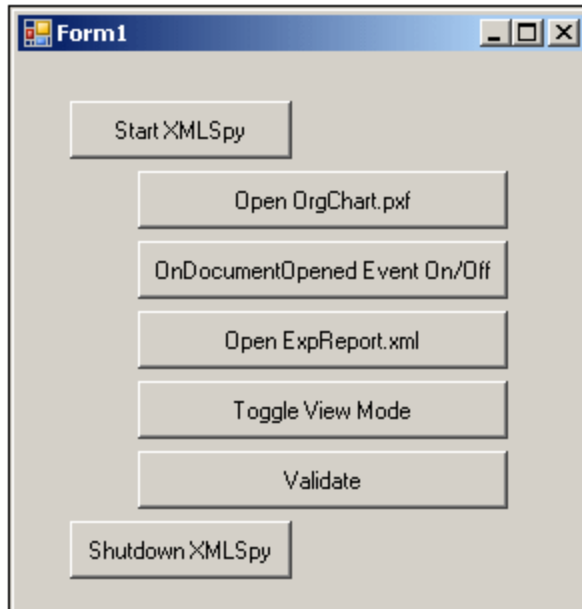

- [Start XMLSpy](#)¹¹⁵⁴: Starts XMLSpy, which is registered as an automation server, or activates the application if it is already running.
- [Open OrgChart.pxf](#)¹¹⁵⁵: Locates one of the example documents installed with XMLSpy and opens it. If this document is already open it becomes the active document.
- [OnDocumentOpened Event On/Off](#)¹¹⁵⁶: Shows how to listen to XMLSpy events. When turned on, a message box will pop up after a document has been opened.
- [Open ExpReport.xml](#)¹¹⁵⁵: Opens another example document.
- [Toggle View Mode](#)¹¹⁵⁶: Changes the view of all open documents between Text View and Authentic View. The code shows how to iterate through open documents.
- [Validate](#)¹¹⁵⁷: Validates the active document and shows the result in a message box. The code shows how to handle errors and COM output parameters.
- [Shut down XMLSpy](#)¹¹⁵⁴: Stops XMLSpy.

You can modify the code (of the code listing below or of the example C# project in the API Examples folder) in any way you like and run it.

Compiling and running the example

In the API Examples folder, double-click the file `AutomateXMLSpy_VS2008.sln` or the file `AutomateXMLSpy_VS2010.sln` (to open in Visual Studio 2012/2013/2015/2017/2019/2022). Alternatively the file can be opened from within Visual Studio (with **File | Open | Project/Solution**). To compile and run the example, select **Debug | Start Debugging** or **Debug | Start Without Debugging**.

Code listing of the example

Given below is the C# code listing of the basic functionality of the form (`Form1.cs`) created in the `AutomateXMLSpy` example. Note that the code listed below might differ slightly from the code in the API Examples form. The listing below is commented for ease of understanding. Parts of the code are also presented separately in the sub-sections of this section, according to the Application API functionality they access.

The code essentially consists of a series of handlers for the buttons in the user interface shown in the screenshot above.

```
namespace WindowsFormsApplication2
{
    public partial class Form1 : Form
    {
        public Form1()
        {
            InitializeComponent();
        }

        // An instance of XMLSpy accessed via its automation interface
        XMLSpyLib.Application XMLSpy;

        // Location of examples installed with XMLSpy
        String strExamplesFolder;

        private void Form1_Load(object sender, EventArgs e)
        {
            // Locate examples installed with XMLSpy
            // REMARK: You might need to adapt this if you have a different major version
of the product
            strExamplesFolder = Environment.GetEnvironmentVariable("USERPROFILE") + "\\My
Documents\\Altova\\XMLSpy2012\\Examples\\";
        }

        // Handler for the "Start XMLSpy" button
        private void StartXMLSpy_Click(object sender, EventArgs e)
        {
            if (XMLSpy == null)
            {
                Cursor.Current = Cursors.WaitCursor;

                // If no XMLSpy instance is open, create one and make it visible
                XMLSpy = new XMLSpyLib.Application();
                XMLSpy.Visible = true;

                Cursor.Current = Cursors.Default;
            }
            else
            {
                // If an instance of XMLSpy is already running, make sure it's visible
                if (!XMLSpy.Visible)
                    XMLSpy.Visible = true;
            }
        }

        // Handler for the "Open OrgChart.pxf" button
        private void openOrgChart_Click(object sender, EventArgs e)
        {
            // Make sure there's a running XMLSpy instance, and that it's visible
            StartXMLSpy_Click(null, null);

            // Open one of the example files installed with the product

```

```

        XMLSpy.Documents.OpenFile(strExamplesFolder + "OrgChart.pxf", false);
    }

    // Handler for the "Open ExpReport.xml" button
    private void openExpReport_Click(object sender, EventArgs e)
    {
        // Make sure there's a running XMLSpy instance, and that it's visible
        StartXMLSpy_Click(null, null);

        // Open one of the sample files installed with the product.
        XMLSpy.Documents.OpenFile(strExamplesFolder + "ExpReport.xml", false);
    }

    // Handler for the "Toggle View Mode" button
    private void toggleView_Click(object sender, EventArgs e)
    {
        // Make sure there's a running XMLSpy instance, and that it's visible
        StartXMLSpy_Click(null, null);

        // Iterate through all open documents and toggle view between Text View and
Authentic View
        foreach (XMLSpyLib.Document doc in XMLSpy.Documents)
            if (doc.CurrentViewMode == XMLSpyLib.SPYViewModes.spyViewText)
                doc.SwitchViewMode(XMLSpyLib.SPYViewModes.spyViewAuthentic);
            else
                doc.SwitchViewMode(XMLSpyLib.SPYViewModes.spyViewText);
    }

    // Handler for the "Shutdown XMLSpy" button
    // Shut down the application instance by explicitly releasing the COM object
    private void shutdownXMLSpy_Click(object sender, EventArgs e)
    {
        if (XMLSpy != null)
        {
            // Allow shutdown of XMLSpy by releasing the UI
            XMLSpy.Visible = false;

            // Explicitly release the COM object
            try
            {
                while (System.Runtime.InteropServices.Marshal.ReleaseComObject(XMLSpy)
> 0) ;
            }
            finally
            {
                // Disallow subsequent access to this object
                XMLSpy = null;
            }
        }
    }

    // Handler for button "Validate"
    private void validate_Click(object sender, EventArgs e)
    {
        // COM errors are returned to C# as exceptions. We use a try/catch block to
handle them.

```

```

        try
        {
            // Method 'IsValid' is one of the few functions that uses output parameters
            // Use 'object' type for these parameters
            object strErrorText = "";
            object nErrorNumber = 0;
            object errorData = null;

            if (!XMLSpy.ActiveDocument.IsValid(ref strErrorText, ref nErrorNumber, ref
errorData))
            {
                // The COM call succeeded but the document is not valid
                // A detailed description of the problem is returned in strErrorText,
nErrorNumber and errorData
                listBoxMessages.Items.Add("Document " + XMLSpy.ActiveDocument.Name + "
is not valid.");
                listBoxMessages.Items.Add("\tErrorText : " + strErrorText);
                listBoxMessages.Items.Add("\tErrorNumber: " + nErrorNumber);
                listBoxMessages.Items.Add("\tElement : " + (errorData != null ?
((XMLSpyLib.XMLData)errorData).TextValue : "null"));
            }
            else
            {
                // The COM call succeeded and the document is valid
                listBoxMessages.Items.Add("Document " + XMLSpy.ActiveDocument.Name + "
is valid.");
            }
        }
        catch (Exception ex)
        {
            // The COM call was not successful
            // Probably no application instance has been started or no document is
open.
            listBoxMessages.Items.Add("Error validating active document: " +
ex.Message);
        }
    }

    // Event handler for OnDocumentOpened event
    private void handleOnDocumentOpened(XMLSpyLib.Document i_ipDocument)
    {
        MessageBox.Show("Document " + i_ipDocument.Name + " was opened!");
    }

    // Remember if the event handler is currently registered.
    private bool bEventHandlerIsRegistered = false;

    // Handler for button 'OnDocuemntOpened Event On/Off
    private void toggleOnDocumentOpenedEvent_Click(object sender, EventArgs e)
    {
        if (XMLSpy != null)
        {
            if (bEventHandlerIsRegistered)

```

```

        XMLSpy.OnDocumentOpened -= new
XMLSpyLib._IApplicationEvents_OnDocumentOpenedEventHandler (handleOnDocumentOpened);
        else
            XMLSpy.OnDocumentOpened += new
XMLSpyLib._IApplicationEvents_OnDocumentOpenedEventHandler (handleOnDocumentOpened);

        bEventHandlerIsRegistered = !bEventHandlerIsRegistered;
    }
}
}
}
}

```

26.3.1.2.3.1 Add Reference to XMLSpy API

Add the application's type library as a reference in a .NET project as follows: With the .NET project open, click **Project | Add Reference**. Then browse for the type library, which is called `XMLSpy.tlb`, and is located in the XMLSpy application folder.

Then declare a variable to access the XMLSpy API:

```

// An instance of XMLSpy is accessed via its automation interface.
XMLSpyLib.Application XMLSpy;

```

26.3.1.2.3.2 Application Startup and Shutdown

In the code snippets below, the methods `StartXMLSpy_Click` and `ShutdownXMLSpy_Click` are those assigned to buttons in the [AutomateXMLSpy example](#)¹¹⁴⁹ that, respectively, start up and shut down the application. This example is located in the `C#` subfolder of the API Examples folder (see the file `Form1.cs`):

| | |
|---|--|
| Windows 7, Windows 8,
Windows 10, Windows 11 | C:\Users\<<username>\Documents\
Altova\XMLSpy\2024\Examples |
|---|--|

You can compile and run the project from within Visual Studio 2012/2013/2015/2017/2019/2022.

Starting XMLSpy

The following code snippet from the [AutomateXMLSpy example](#)¹¹⁴⁹ shows how to start up the application.

```

// Handler for the "Start XMLSpy" button
private void StartXMLSpy_Click(object sender, EventArgs e)
{
    if (XMLSpy == null)
    {
        Cursor.Current = Cursors.WaitCursor;

        // If no XMLSpy instance is running, we create one and make it visible
        XMLSpy = new XMLSpyLib.Application();
        XMLSpy.Visible = true;
    }
}

```

```

        Cursor.Current = Cursors.Default;
    }
    else
    {
        // If an instance of XMLSpy is already running, make sure it's visible
        if (!XMLSpy.Visible)
            XMLSpy.Visible = true;
    }
}

```

Shutting down XMLSpy

The following code snippet from the [AutomateXMLSpy example](#)¹¹⁴⁹ shows how to shut down the application.

```

// Handler for the "Shutdown XMLSpy" button
// Shut down the application instance by explicitly releasing the COM object
private void shutdownXMLSpy_Click(object sender, EventArgs e)
{
    if (XMLSpy != null)
    {
        // Allow shutdown of XMLSpy by releasing the UI
        XMLSpy.Visible = false;

        // Explicitly release COM object
        try
        {
            while (System.Runtime.InteropServices.Marshal.ReleaseComObject (XMLSpy)
                > 0) ;
        }
        finally
        {
            // Disallow subsequent access to this object
            XMLSpy = null;
        }
    }
}

```

26.3.1.2.3.3 Opening Documents

The code snippets below (from the [AutomateXMLSpy example](#)¹¹⁴⁹) show how two files are opened via two separate methods assigned to two buttons in the user interface. Both methods use the same Application API access mechanism: [XMLSpy.Documents.OpenFile\(string, boolean\)](#)¹²⁹⁸.

The [AutomateXMLSpy example](#)¹¹⁴⁹ (see the file *Form1.cs*) is located in the C# subfolder of the API Examples folder:

| | |
|---|--|
| Windows 7, Windows 8,
Windows 10, Windows 11 | C:\Users\<<username>\Documents\
Altova\XMLSpy\2024\Examples |
|---|--|

You can compile and run the project from within Visual Studio 2012/2013/2015/2017/2019/2022.

Code snippet

```
// Handler for the "Open OrgChart.pxf" button
private void openOrgChart_Click(object sender, EventArgs e)
{
    // Make sure there's a running XMLSpy instance, and that it's visible
    StartXMLSpy_Click(null, null);

    // Open a file from the Examples folder installed with the product
    XMLSpy.Documents.OpenFile(strExamplesFolder + "OrgChart.pxf", false);
}

// Handler for the "Open ExpReport.xml" button
private void openExpReport_Click(object sender, EventArgs e)
{
    // Make sure there's a running XMLSpy instance, and that it's visible
    StartXMLSpy_Click(null, null);

    // Open a file from the Examples folder installed with the product
    XMLSpy.Documents.OpenFile(strExamplesFolder + "ExpReport.xml", false);
}
```

The file opened last will be the active file.

26.3.1.2.3.4 Iterating through Open Documents

The code snippet below (from the [AutomateXMLSpy example](#)¹¹⁴⁹; see the file *Form1.cs*) shows how to iterate through open documents. A condition is then tested within the iteration loop, and the document view is switched between Text View and Authentic View.

```
// Handler for the "Toggle view mode" button
private void toggleView_Click(object sender, EventArgs e)
{
    // Make sure there's a running XMLSpy instance, and that it's visible
    StartXMLSpy_Click(null, null);

    // Iterate through open documents and toggle current view between text and
    authentic view.
    foreach (XMLSpyLib.Document doc in XMLSpy.Documents)
        if (doc.CurrentViewMode == XMLSpyLib.SPYViewModes.spyViewText)
            doc.SwitchViewMode(XMLSpyLib.SPYViewModes.spyViewAuthentic);
        else
            doc.SwitchViewMode(XMLSpyLib.SPYViewModes.spyViewText);
}
```

The [AutomateXMLSpy example](#)¹¹⁴⁹ example is located in the C# subfolder of the API Examples folder:

| | |
|---|--|
| Windows 7, Windows 8,
Windows 10, Windows 11 | C:\Users\<>username>\Documents\
Altova\XMLSpy\2024\Examples |
|---|--|

You can compile and run the project from within Visual Studio 2012/2013/2015/2017/2019/2022.

26.3.1.2.3.5 Errors and COM Output Parameters

The code snippet below (from the [AutomateXMLSpy example](#)¹¹⁴⁹) shows how to handle errors and COM output parameters. The method [XMLSpy.ActiveDocument.IsValid\(ref strErrorText, ref nErrorNumber, ref errorData\)](#)¹²⁸⁴ uses output parameters that are used, in the code snippet below, to generate an error-message text.

The [AutomateXMLSpy example](#)¹¹⁴⁹ (see the file *Form1.cs*) is located in the C# subfolder of the API Examples folder:

| | |
|---|--|
| Windows 7, Windows 8,
Windows 10, Windows 11 | C:\Users\<>username>\Documents\
Altova\XMLSpy\2024\Examples |
|---|--|

You can compile and run the project from within Visual Studio 2012/2013/2015/2017/2019/2022.

Code snippet

```
// Handler for button "Validate"
private void validate_Click(object sender, EventArgs e)
{
    // COM errors are returned to C# as exceptions. We use a try/catch block to
handle them.
    try
    {
        // Method 'IsValid' is one of the few functions that uses output parameters
        // Use 'object' type for these parameters
        object strErrorText = "";
        object nErrorNumber = 0;
        object errorData = null;

        if (!XMLSpy.ActiveDocument.IsValid(ref strErrorText, ref nErrorNumber, ref
errorData))
        {
            // The COM call succeeded but the document is not valid
            // A detailed description of the problem is returned in strErrorText,
nErrorNumber and errorData
            listBoxMessages.Items.Add("Document " + XMLSpy.ActiveDocument.Name + "
is not valid.");
            listBoxMessages.Items.Add("\tErrorText : " + strErrorText);
            listBoxMessages.Items.Add("\tErrorNumber: " + nErrorNumber);
            listBoxMessages.Items.Add("\tElement      : " + (errorData != null ?
(XMLSpyLib.XMLData)errorData).TextValue : "null");
        }
        else
        {

```

```

        // The COM call succeeded and the document is valid
        listBoxMessages.Items.Add("Document " + XMLSpy.ActiveDocument.Name + "
is valid.");
    }
}
catch (Exception ex)
{
    // The COM call was not successful
    // Probably no application instance has been started or no document is
open.
    listBoxMessages.Items.Add("Error validating active document: " +
ex.Message);
}
}
}

```

26.3.1.2.3.6 Events

The code snippet below (from the [AutomateXMLSpy example](#)¹¹⁴⁹) lists the code for two event handlers. The [AutomateXMLSpy example](#)¹¹⁴⁹ (see the file *Form1.cs*) is located in the C# subfolder of the API Examples folder:

| | |
|---|--|
| Windows 7, Windows 8,
Windows 10, Windows 11 | C:\Users\<<username>\Documents\
Altova\XMLSpy\2024\Examples |
|---|--|

You can compile and run the project from within Visual Studio 2012/2013/2015/2017/2019/2022.

Code snippet

```

// Event handler for OnDocumentOpened event
private void handleOnDocumentOpened(XMLSpyLib.Document i_ipDocument)
{
    MessageBox.Show("Document " + i_ipDocument.Name + " was opened!");
}

// Remember if the event handler is currently registered.
private bool bEventHandlerIsRegistered = false;

// Handler for button 'OnDocuemntOpened Event On/Off
private void toggleOnDocumentOpenedEvent_Click(object sender, EventArgs e)
{
    if (XMLSpy != null)
    {
        if (bEventHandlerIsRegistered)
            XMLSpy.OnDocumentOpened -= new
XMLSpyLib._IApplicationEvents_OnDocumentOpenedEventHandler (handleOnDocumentOpened);
        else
            XMLSpy.OnDocumentOpened += new
XMLSpyLib._IApplicationEvents_OnDocumentOpenedEventHandler (handleOnDocumentOpened);

        bEventHandlerIsRegistered = !bEventHandlerIsRegistered;
    }
}

```

```
    }
}
```

26.3.1.2.4 Java

The Application API can be accessed from Java code. To allow accessing the XMLSpy automation server directly from Java code, the libraries listed below must reside in the `classpath`. They are installed in the folder: `JavaAPI` in the XMLSpy application folder.

- `AltovaAutomation.dll`: a JNI wrapper for Altova automation servers (`AltovaAutomation_x64.dll` in the case of 64-bit versions)
- `AltovaAutomation.jar`: Java classes to access Altova automation servers
- `XMLSpyAPI.jar`: Java classes that wrap the XMLSpy automation interface
- `XMLSpyAPI_JavaDoc.zip`: a Javadoc file containing help documentation for the Java API

Note: In order to use the Java API, the DLL and Jar files must be on the Java Classpath.

Example Java project

An example Java project is supplied with your product installation. You can test the Java project and modify and use it as you like. For more details of the example Java project, see the section, [Example Java Project](#)¹¹⁶⁰.

Rules for mapping the Application API names to Java

The rules for mapping between the Application API and the Java wrapper are as follows:

- **Classes and class names**
For every interface of the XMLSpy automation interface a Java class exists with the name of the interface.
- **Method names**
Method names on the Java interface are the same as used on the COM interfaces but start with a small letter to conform to Java naming conventions. To access COM properties, Java methods that prefix the property name with `get` and `set` can be used. If a property does not support write-access, no setter method is available. Example: For the `Name` property of the `Document` interface, the Java methods `getName` and `setName` are available.
- **Enumerations**
For every enumeration defined in the automation interface, a Java enumeration is defined with the same name and values.
- **Events and event handlers**
For every interface in the automation interface that supports events, a Java interface with the same name plus 'Event' is available. To simplify the overloading of single events, a Java class with default implementations for all events is provided. The name of this Java class is the name of the event interface plus 'DefaultHandler'. For example:
Application: Java class to access the application
ApplicationEvents: Events interface for the Application
ApplicationEventsDefaultHandler: Default handler for ApplicationEvents

Exceptions to mapping rules

There are some exceptions to the rules listed above. These are listed below:

| Interface | Java name |
|-------------------------------------|-----------------|
| Document, method SetEncoding | setFileEncoding |
| AuthenticView, method Goto | gotoElement |
| AuthenticRange, method Goto | gotoElement |
| AuthenticRange, method Clone | cloneRange |

This section

This section explains how some basic XMLSpy functionality can be accessed from Java code. It is organized into the following sub-sections:

- [Example Java Project](#) ¹¹⁶⁰
- [Application Startup and Shutdown](#) ¹¹⁶⁴
- [Simple Document Access](#) ¹¹⁶⁵
- [Iterations](#) ¹¹⁶⁵
- [Use of Out-Parameters](#) ¹¹⁶⁵
- [Event Handlers](#) ¹¹⁶⁶

26.3.1.2.4.1 Example Java Project

The XMLSpy installation package contains an example Java project, located in the the `API\Java` subfolder of the `Examples` folder :

| | |
|---|--|
| Windows 7, Windows 8,
Windows 10, Windows 11 | C:\Users\ <username>\Documents\
Altova\XMLSpy\2024\Examples</username> |
|---|--|

This folder contains Java examples for the XMLSpy API. You can test it directly from the command line using the batch file `BuildAndRun.bat`, or you can compile and run the example project from within Eclipse. See below for instructions on how to use these procedures.

File list

The Java examples folder contains all the files required to run the example project. These files are listed below. If you are using a 64-bit version of the application, some filenames contain `_x64` in the name. These filenames are indicated with `(_x64)`.

| | |
|-------------------------------------|------------------------------------|
| AltovaAutomation(<u>_x64</u>).dll | Java-COM bridge: DLL part |
| AltovaAutomation.jar | Java-COM bridge: Java library part |
| XMLSpyAPI.jar | Java classes of the XMLSpy API |
| RunXMLSpy.java | Java example source code |

| | |
|-----------------------|--|
| BuildAndRun.bat | Batch file to compile and run example code from the command line prompt. Expects folder where Java Virtual Machine resides as parameter. |
| .classpath | Eclipse project helper file |
| .project | Eclipse project file |
| XMLSpyAPI_JavaDoc.zip | Javadoc file containing help documentation for the Java API |

What the example does

The example starts up XMLSpy and performs a few operations, including opening and closing documents. When done, XMLSpy stays open. You must close it manually.

- [Start XML Spy](#)¹¹⁶⁴: Starts XMLSpy, which is registered as an automation server, or activates XMLSpy if it is already running.
- [Open OrgChart.pxf](#)¹¹⁶⁵: Locates one of the example documents installed with XMLSpy and opens it.
- [Iteration and Changing the View Mode](#)¹¹⁶⁵: Changes the view of all open documents to Text View. The code also shows how to iterate through open documents.
- [Iteration, validation, output parameters](#)¹¹⁶⁵: Validates the active document and shows the result in a message box. The code shows how to use output parameters.
- [Event Handling](#)¹¹⁶⁶: Shows how to handle XMLSpy events.
- [Shut down XMLSpy](#)¹¹⁶⁴: Shuts down XMLSpy.

You can modify the example in any way you like and run it.

Running the example from the command line

To run the example from the command line, open a command prompt window, go to the Java folder of the API Examples folder (see above for location), and then type:

```
buildAndRun.bat "<Path-to-the-Java-bin-folder>"
```

The Java binary folder must be that of a JDK 14 or later installation on your computer. Press the **Return** key. The Java source in `RunXMLSpy.java` will be compiled and then executed.

Loading the example in Eclipse

Open Eclipse and use the **Import | Existing Projects into Workspace** command to add the Eclipse project file (`.project`) located in the Java folder of the API Examples folder (see above for location). The project `RunXMLSpy` will then appear in your Package Explorer or Navigator. Select the project and then the command **Run as | Java Application** to execute the example.

Note: You can select a class name or method of the Java API and press F1 to get help for that class or method.

Java source code listing

The Java source code in the example file `RunXMLSpy.java` is listed below with comments.

```
001 // Access general JAVA-COM bridge classes
```

```
002 import com.altova.automation.libs.*;
003
004 // Access XMLSpy Java-COM bridge
005 import com.altova.automation.XMLSpy.*;
006 import com.altova.automation.XMLSpy.Enums.SPYViewModes;
007
008 /**
009  * An example that starts XMLSpy COM server and performs view operations on it
010  * Feel free to extend
011  */
012 public class RunXMLSpy
013 {
014     public static void main(String[] args)
015     {
016         // An instance of the application.
017         Application xmlSpy = null;
018
019         // Instead of COM error handling, use Java exception mechanism
020         try
021         {
022             // Start XMLSpy as COM server
023             xmlSpy = new Application();
024
025             // COM servers start up invisible, so make it visible
026             xmlSpy.setVisible(true);
027
028             // Locate samples installed with the product
029             String strExamplesFolder =
030             System.getenv("USERPROFILE") + "\\My Documents\\Altova\\XMLSpy2012\\Examples\\";
031
032             // Open two example files
033             xmlSpy.getDocuments().openFile(strExamplesFolder + "OrgChart.pxf", false);
034             xmlSpy.getDocuments().openFile(strExamplesFolder + "ExpReport.xml", false);
035
036             // Iterate through open documents and set view mode to 'Text'.
037             for (Document doc:xmlSpy.getDocuments())
038             if ( doc.getCurrentViewMode() != SPYViewModes.spyViewText)
039                 doc.switchViewMode(SPYViewModes.spyViewText);
040
041             // An alternative iteration mode is index-based
042             // COM indices are typically zero-based
043             Documents documents = xmlSpy.getDocuments();
044             for (int i = 1; i <= documents.getCount();
045                 i++)
046             {
047                 Document doc = documents.getItem(i);
048
049                 // Validation is one of the few methods to have output parameters.
050                 // The class JVariant is the correct type for parameters in these cases.
051                 // To get values back mark them with the by-reference flag.
052                 JVariant validationErrorText = new
053
054                 JVariant.JStringVariant("");
055
056                 validationErrorText.setByRefFlag();
057                 JVariant validationErrorCount = new
```

```
058
059     JVariant.JIntVariant(0);
060
061     validationErrorCount.setByRefFlag();
062     JVariant validationErrorXMLData = new
063
064     JVariant.JIDispatchVariant(0);
065
066     validationErrorXMLData.setByRefFlag();
067     if (!doc.isValid(validationErrorText, validationErrorCount,
validationErrorXMLData))
068         System.out.println("Document" + doc.getName() + " is not wellformed - " +
validationErrorText.getStringValue());
069     else
070         System.out.println("Document" + doc.getName() + " is wellformed.");
071     }
072
073     // The following lines attach to the document events using a default
implementation
074     // for the events and override one of its methods.
075     // If you want to override all document events it is better to derive your
listener class
076     // from DocumentEvents and implement all methods of this interface.
077     Document doc = xmlSpy.getActiveDocument();
078     doc.addListener(new
079
080 DocumentEventsDefaultHandler()
081     {
082         @Override
083         public boolean
084
085 onBeforeCloseDocument(Document i_ipDoc) throws AutomationException
086     {
087         System.out.println("Document
088
089 " + i_ipDoc.getName() + " requested closing.");
090
091         // Allow closing of document
092         return true;
093     }
094 });
095 doc.close(true);
096 doc = null;
097
098     System.out.println("Watch XMLSpy!");
099 }
100 catch (AutomationException e)
101 {
102     // e.printStackTrace();
103 }
104 finally
105 {
106     // Make sure that XMLSpy can shut down properly.
107     if (xmlSpy != null)
108         xmlSpy.dispose();
109 }
```

```
110     // Since the COM server was made visible and still is visible,
111     // it will keep running, and needs to be closed manually.
112     System.out.println("Now close XMLSpy!");
113 }
114 }
115 }
```

26.3.1.2.4.2 Application Startup and Shutdown

The code listings below show how the application can be started up and shut down.

Application startup

Before starting up the application, the appropriate classes must be imported (*see below*).

```
01 // Access general JAVA-COM bridge classes
02 import com.altova.automation.libs.*;
03
04 // Access XMLSpy Java-COM bridge
05 import com.altova.automation.XMLSpy.*;
06 import com.altova.automation.XMLSpy.Enums.SPYViewModes;
07
08 /**
09  * An example that starts XMLSpy COM server and performs view operations on it
10  * Feel free to extend
11  */
12 public class RunXMLSpy
13 {
14     public static void main(String[] args)
15     {
16         // An instance of the application.
17         Application xmlSpy = null;
18
19         // Instead of COM error handling, use Java exception mechanism
20         try
21         {
22             // Start XMLSpy as COM server
23             xmlSpy = new Application();
24             // COM servers start up invisible, so make it visible
25             xmlSpy.setVisible(true);
26
27         ...
28         }
29     }
30 }
```

Application shutdown

The application can be shut down as shown below.

```
01 {
02     // Allow shutdown of XMLSpy by releasing the UI.
03     xmlSpy.setVisible(true);
```



```
04
05     // Make sure that XMLSpy can shut down properly.
06     if (xmlSpy != null)
07         xmlSpy.dispose();
08
09     // Since the COM server was made visible and still is visible,
10     // it will keep running, and needs to be closed manually.
11     System.out.println("Now close XMLSpy!");
12 }
```

26.3.1.2.4.3 Simple Document Access

The code listing below shows how to open a document.

```
1 // Locate samples installed with the product
2 String strExamplesFolder =
3 System.getenv("USERPROFILE") + "\\My Documents\\Altova\\XMLSpy2012\\Examples\\";
4
5
6 // Open file
7 xmlSpy.getDocuments().openFile(strExamplesFolder + "OrgChart.pxf", false);
```

26.3.1.2.4.4 Iterations

The listing below shows how to iterate through open documents.

```
01 // Iterate through open documents and set view mode to 'Text'.
02 for (Document doc:xmlSpy.getDocuments())
03     if ( doc.getCurrentViewMode() != SPYViewModes.spyViewText)
04         doc.switchViewMode(SPYViewModes.spyViewText);
05
06 // An alternative iteration mode is index-based
07 // COM indices are typically zero-based
08 Documents documents = xmlSpy.getDocuments();
09     for (int i = 1; i <= documents.getCount();
10         i++)
11     {
12         Document doc = documents.getItem(i);
13         ...
14     }
```

26.3.1.2.4.5 Use of Out-Parameters

The code listing below iterates through open documents and validates each of them. For each validation, a message is generated using the output parameters of the Validation method.

```
01 // An alternative iteration mode is index-based
02 // COM indices are typically zero-based
03 Documents documents = xmlSpy.getDocuments();
04 for (int i = 1; i <= documents.getCount();
05     i++)
06     {
07         Document doc = documents.getItem(i);
08
09 // Validation is one of the few methods to have output parameters.
10 // The class JVariant is the correct type for parameters in these cases.
11 // To get values back mark them with the by-reference flag.
12 JVariant validationErrorText = new
13
14 JVariant.JStringVariant("");
15
16 validationErrorText.setByRefFlag();
17     JVariant validationErrorCount = new
18
19 JVariant.JIntVariant(0);
20
21 validationErrorCount.setByRefFlag();
22     JVariant validationErrorXMLData = new
23
24 JVariant.JIDispatchVariant(0);
25
26 validationErrorXMLData.setByRefFlag();
27     if (!doc.isValid(validationErrorText,
28
29     validationErrorCount, validationErrorXMLData))
30         System.out.println("Document
31
32     " + doc.getName() + " is not wellformed - " +
33
34     validationErrorText.getStringValue());
35     else
36         System.out.println("Document
37
38     " + doc.getName() + " is wellformed.");
39     }
```

26.3.1.2.4.6 Event Handlers

The listing below shows how to listen for and use events.

```
01 // The following lines attach to the document events using a default implementation
02 // for the events and override one of its methods.
03 // If you want to override all document events it is better to derive your listener
class
04 // from DocumentEvents and implement all methods of this interface.
05
```

```

06 Document doc = xmlSpy.getActiveDocument();
07 doc.addListener(new DocumentEventsDefaultHandler()
08     {
09         @Override
10         public boolean
11         onBeforeCloseDocument(Document i_ipDoc) throws AutomationException
12         {
13             System.out.println("Document " + i_ipDoc.getName() + " requested closing.");
14
15             // Allow closing of document
16             return true;
17         }
18     });
19 doc.close(true);
20 doc = null;

```

26.3.1.3 The DOM and XMLData

The `XMLData` interface gives you full access to the XML structure behind the current document with less methods than DOM and is much simpler. The `XMLData` interface is a minimalist approach to reading and modifying existing, or newly created XML data. You might however, want to use a DOM tree because you can access one from an external source or you just prefer the MSXML DOM implementation.

The `ProcessDOMNode()` and `ProcessXMLDataNode()` functions provided below convert any segments of an XML structure between `XMLData` and DOM.

To use the `ProcessDOMNode()` function:

- pass the root element of the DOM segment you want to convert in `objNode` and
- pass the plugin object with the `CreateChild()` method in `objCreator`

To use the `ProcessXMLDataNode()` function:

- pass the root element of the `XMLData` segment in `objXMLData` and
- pass the `DOMDocument` object created with MSXML in `xmlIDoc`

```

////////////////////////////////////
// DOM To XMLData conversion
Function ProcessDOMNode(objNode,objCreator)
{
    var objRoot;
    objRoot = CreateXMLDataFromDOMNode(objNode,objCreator);

    If(objRoot) {
        If((objNode.nodeValue != Null) && (objNode.nodeValue.length > 0))
            objRoot.TextValue = objNode.nodeValue;
        // add attributes
        If(objNode.attributes) {
            var Attribute;
            var oNodeList = objNode.attributes;

            For(var i = 0;i < oNodeList.length; i++) {
                Attribute = oNodeList.item(i);

```

```

        var newNode;
        newNode = ProcessDOMNode(Attribute,objCreator);

        objRoot.AppendChild(newNode);
    }
}
If(objNode.hasChildNodes) {
    try {
        // add children
        var Item;
        oNodeList = objNode.childNodes;

        For(var i = 0;i < oNodeList.length; i++) {
            Item = oNodeList.item(i);

            var newNode;
            newNode = ProcessDOMNode(Item,objCreator);

            objRoot.AppendChild(newNode);
        }
    }
    catch(err) {
    }
}
}
Return objRoot;
}

Function CreateXMLDataFromDOMNode(objNode,objCreator)
{
    var bSetName = True;
    var bSetValue = True;

    var nKind = 4;

    switch(objNode.nodeType) {
        Case 2:nKind = 5;break;
        Case 3:nKind = 6;bSetName = False;break;
        Case 4:nKind = 7;bSetName = False;break;
        Case 8:nKind = 8;bSetName = False;break;
        Case 7:nKind = 9;break;
    }
    var objNew = Null;
    objNew = objCreator.CreateChild(nKind);

    If(bSetName)
        objNew.Name = objNode.nodeName;

    If(bSetValue && (objNode.nodeValue != Null))
        objNew.TextValue = objNode.nodeValue;

    Return objNew;
}
////////////////////////////////////
// XMLData To DOM conversion

```

```
Function ProcessXMLDataNode (objXMLData, xmlDoc)
{
    var objRoot;
    objRoot = CreateDOMNodeFromXMLData (objXMLData, xmlDoc);

    If(objRoot) {
        If(IsTextNodeEnabled(objRoot) && (objXMLData.TextValue.length > 0))
            objRoot.appendChild(xmlDoc.createTextNode(objXMLData.TextValue));

        If(objXMLData.HasChildren) {
            try {
                var objChild;
                objChild = objXMLData.GetFirstChild(-1);

                While(True) {
                    If(objChild) {
                        var newNode;
                        newNode = ProcessXMLDataNode (objChild, xmlDoc);

                        If(newNode.nodeType == 2) {
                            // child node is an attribute
                            objRoot.attributes.setNamedItem(newNode);
                        }
                        Else
                            objRoot.appendChild(newNode);
                    }
                    objChild = objXMLData.GetNextChild();
                }
            }
            catch(err) {
            }
        }
    }
    Return objRoot;
}

Function CreateDOMNodeFromXMLData (objXMLData, xmlDoc)
{
    switch(objXMLData.Kind) {
        Case 4:Return xmlDoc.createElement(objXMLData.Name);
        Case 5:Return xmlDoc.createAttribute(objXMLData.Name);
        Case 6:Return xmlDoc.createTextNode(objXMLData.TextValue);
        Case 7:Return xmlDoc.createCDATASection(objXMLData.TextValue);
        Case 8:Return xmlDoc.createComment(objXMLData.TextValue);
        Case 9:Return
xmlDoc.createProcessingInstruction(objXMLData.Name, objXMLData.TextValue);
    }

    Return xmlDoc.createElement(objXMLData.Name);
}

Function IsTextNodeEnabled(objNode)
{
    switch(objNode.nodeType) {
        Case 1:
        Case 2:
```

```

    Case 5:
    Case 6:
    Case 11:Return True;
}
Return False;
}

```

26.3.1.4 Obsolete: Authentic View Row operations

If the schema on which an XML document is based specifies that an element is repeatable, such a structure can be represented in Authentic View as a table. When represented as a table, rows and their contents can be manipulated individually, thereby allowing you to manipulate each of the repeatable elements individually. Such row operations would be performed by an external script.

If an external script is to perform row operations then two steps must occur:

- The first step checks whether the cursor is currently in a row using a property. Such a check could be, for example, `IsRowInsertEnabled`, which returns a value of either `TRUE` or `FALSE`.
- If the return value is `TRUE` then a row method, such as `RowAppend`, can be called. (`RowAppend` has no parameters and returns no value.)

The following is a list of properties and methods available for table operations. Each property returns a `BOOL`, and the methods have no parameter.

| Property | Method | Table operations |
|------------------------------------|--|----------------------------------|
| <code>IsRowInsertEnabled</code> | RowInsert ¹⁴¹⁸ , superseded by AuthenticRange.InsertRow ¹²¹⁶ | Insert row operation |
| <code>IsRowAppendEnabled</code> | RowAppend ¹⁴¹⁷ , superseded by AuthenticRange.AppendRow ¹²⁰¹ | Append row operation |
| <code>IsRowDeleteEnabled</code> | RowDelete ¹⁴¹⁷ , superseded by AuthenticRange.DeleteRow ¹²⁰⁵ | Delete row operation |
| <code>IsRowMoveUpEnabled</code> | RowMoveUp ¹⁴¹⁹ , superseded by AuthenticRange.MoveRowUp ¹²²³ | Move XML data up one row |
| <code>IsRowMoveDownEnabled</code> | RowMoveDown ¹⁴¹⁹ , superseded by AuthenticRange.MoveRowDown ¹²²³ | Move XML data down one row |
| <code>IsRowDuplicateEnabled</code> | RowDuplicate ¹⁴¹⁸ , superseded by AuthenticRange.DuplicateRow ¹²⁰⁵ | Duplicate currently selected row |

26.3.1.5 Obsolete: Authentic View Editing operations

When XML data is displayed as data in Authentic View, it is possible to manipulate individual elements using standard editing operations such as cut, copy, and paste. However, not all XML data nodes can be edited. So, in order to carry out an editing operation, first a property is used to test whether editing is possible, and then a method is called to perform the editing operation.

The only method that does not have a test is the method `EditSelectAll`, which automatically selects all elements displayed in the document.

The following is a list of properties and methods that perform editing operations. Each property returns a `BOOL`, and the methods have no parameter.

| Property | Method | Editing operation |
|---------------------------------|---|---|
| <code>IsEditUndoEnabled</code> | EditUndo ¹⁴⁰⁵ , superseded by AuthenticView.Undo ¹²⁴⁷ | Undo an editing operation |
| <code>IsEditRedoEnabled</code> | EditRedo ¹⁴⁰⁴ , superseded by AuthenticView.Redo ¹²⁴⁶ | Redo an editing operation |
| <code>IsEditCopyEnabled</code> | EditCopy ¹⁴⁰³ , superseded by AuthenticRange.Copy ¹²⁰⁴ | Copy selected text to the clipboard |
| <code>IsEditCutEnabled</code> | EditCut ¹⁴⁰³ , superseded by AuthenticRange.Cut ¹²⁰⁴ | Cut selected text to the clipboard |
| <code>IsEditPasteEnabled</code> | EditPaste ¹⁴⁰⁴ , superseded by AuthenticRange.Paste ¹²²³ | Paste from clipboard to current cursor position |
| <code>IsEditClearEnabled</code> | EditClear ¹⁴⁰² , superseded by AuthenticRange.Delete ¹²⁰⁴ | Clear selected text from XML document |

26.3.2 Interfaces

Object Hierarchy



[GenerateSampleXMLDlg](#) ¹³²²
[DTDSchemaGeneratorDlg](#) ¹²⁹⁹
[FindInFilesDlg](#) ¹³¹⁰
[DatabaseConnection](#) ¹²⁵⁴
[ExportSettings](#) ¹³⁰⁶
[TextImportExportSettings](#) ¹³⁶⁵
[ElementList](#) ¹³⁰⁴
[ElementListItem](#) ¹³⁰⁵

[Enumerations](#) ¹⁴²²

Description

This chapter contains the reference of the XMLSpy 1.5 Type Library.

Most of the given examples are written in VisualBasic. These code snippets assume that there is a variable defined and set, called **objSpy of type Application**. There are also some code samples written in JavaScript.

26.3.2.1 Application

Methods

[GetDatabaseImportElementList](#) ¹¹⁷⁹
[GetDatabaseSettings](#) ¹¹⁷⁹
[GetDatabaseTables](#) ¹¹⁸⁰
[ImportFromDatabase](#) ¹¹⁸³
[CreateXMLSchemaFromDBStructure](#) ¹¹⁷⁷

[GetTextImportElementList](#) ¹¹⁸¹
[GetTextImportExportSettings](#) ¹¹⁸²
[ImportFromText](#) ¹¹⁸⁵

[ImportFromWord](#) ¹¹⁸⁵

[ImportFromSchema](#) ¹¹⁸⁴

[GetExportSettings](#) ¹¹⁸¹

[NewProject](#) ¹¹⁸⁷

[OpenProject](#) ¹¹⁸⁷

[AddMacroMenuItem](#) ¹¹⁷⁶

[ClearMacroMenu](#) ¹¹⁷⁷

[ShowForm](#) ¹¹⁹⁰

[ShowApplication](#) ¹¹⁹⁰

[URLDelete](#) ¹¹⁹¹

[URLMakeDirectory](#) ¹¹⁹¹

[AddXSLT_XQParameter](#) ¹¹⁷⁶

[GetXSLT_XQParameterCount](#) ¹¹⁸²
[GetXSLT_XQParameterName](#) ¹¹⁸²
[GetXSLT_XQParameterXPath](#) ¹¹⁸³
[RemoveXSLT_XQParameter](#) ¹¹⁸⁹

[FindInFiles](#) ¹¹⁷⁹

[Quit](#) ¹¹⁸⁸

Properties

[Application](#) ¹¹⁷⁶

[Parent](#) ¹¹⁸⁸

[ActiveDocument](#) ¹¹⁷⁵

[Documents](#) ¹¹⁷⁸

[CurrentProject](#) ¹¹⁷⁷

[Dialogs](#) ¹¹⁷⁸

[WarningNumber](#) ¹¹⁹²

[WarningText](#) ¹¹⁹²

[Status](#) ¹¹⁹¹

[MajorVersion](#) ¹¹⁸⁶

[MinorVersion](#) ¹¹⁸⁶

[Edition](#) ¹¹⁷⁸

[IsAPISupported](#) ¹¹⁸⁶

[ServicePackVersion](#) ¹¹⁸⁹

Description

Application is the root for all other objects. It is the only object you can create by CreateObject (VisualBasic) or other similar COM related functions.

Example

```
Dim objSpy As Application
Set objSpy = CreateObject("XMLSpy.Application")
```

26.3.2.1.1 Events

26.3.2.1.1.1 OnBeforeOpenDocument

Event: OnBeforeOpenDocument(*objDialog* as [FileSelectionDlg](#) ¹³⁰⁸)

Description

This event gets fired whenever a document gets opened via the OpenFile or OpenURL menu command. It is sent after a document file has been selected but before the document gets opened. The file selection dialog object is initialized with the name of the selected document file. You can modify this selection. To continue the

opening of the document leave the [FileSelectionDlg.DialogAction](#)¹³⁰⁹ property of *io_objDialog* at its default value [spyDialogOK](#)¹⁴²⁵. To abort the opening of the document set this property to [spyDialogCancel](#)¹⁴²⁵.

Examples

Given below are examples of how this event can be scripted.

XMLSpy scripting environment - VBScript:

```
Function On_BeforeOpenDocument(objDialog)
End Function
```

XMLSpy scripting environment - JScript:

```
function On_BeforeOpenDocument(objDialog)
{
}
```

XMLSpy IDE Plugin:

```
IXMLSpyPlugIn.OnEvent (26, ...) // nEventId = 26
```

26.3.2.1.1.2 OnBeforeOpenProject

Event: OnBeforeOpenProject(*objDialog* as [FileSelectionDlg](#)¹³⁰⁸)

Description

This event gets fired after a project file has been selected but before the project gets opened. The file selection dialog object is initialized with the name of the selected project file. You can modify this selection. To continue the opening of the project leave the [FileSelectionDlg.DialogAction](#)¹³⁰⁹ property of *io_objDialog* at its default value [spyDialogOK](#)¹⁴²⁵. To abort the opening of the project set this property to [spyDialogCancel](#)¹⁴²⁵.

Examples

Given below are examples of how this event can be scripted.

XMLSpy scripting environment - VBScript:

```
Function On_BeforeOpenProject(objDialog)
End Function
```

XMLSpy scripting environment - JScript:

```
function On_BeforeOpenProject(objDialog)
{
}
```

XMLSpy IDE Plugin:

```
IXMLSpyPlugIn.OnEvent (25, ...) // nEventId = 25
```

26.3.2.1.1.3 OnDocumentOpened

Event: OnDocumentOpened(*objDocument* as [Document](#)¹²⁶⁴)

Description

This event gets fired whenever a document opens in XMLSpy. This can happen due to opening a file with the OpenFile or OpenURL dialog, creating a new file or dropping a file onto XMLSpy. The new document gets passed as parameter. The operation cannot be canceled.

Examples

Given below are examples of how this event can be scripted.

XMLSpy scripting environment - VBScript:

```
Function On_OpenDocument(objDocument)
End Function
```

XMLSpy scripting environment - JScript:

```
function On_OpenDocument(objDocument)
{
}
```

XMLSpy IDE Plugin:

```
IXMLSpyPlugIn.OnEvent (7, ...) // nEventId = 7
```

26.3.2.1.1.4 OnProjectOpened

Event: OnProjectOpened(*objProject* as [SpyProject](#)¹³⁵⁹)

Description

This event gets fired whenever a project gets opened in XMLSpy. The new project gets passed as parameter.

Examples

Given below are examples of how this event can be scripted.

XMLSpy scripting environment - VBScript:

```
Function On_OpenProject(objProject)
End Function
```

XMLSpy scripting environment - JScript:

```
function On_OpenProject(objProject)
{
}
```

XMLSpy IDE Plugin:

```
IXMLSpyPlugIn.OnEvent (6, ...) // nEventId = 6
```

26.3.2.1.2 ActiveDocument

Property: ActiveDocument as [Document](#)¹²⁶⁴

Description

Reference to the active document. If no document is open, `ActiveDocument` is null (nothing).

Errors

| | |
|------|---|
| 1111 | The application object is no longer valid. |
| 1100 | Invalid address for the return parameter was specified. |

26.3.2.1.3 AddMacroMenuItem

Method: `AddMacroMenuItem(strMacro as String, strDisplayText as String)`

Description

Adds a menu item to the **Tools** menu. This new menu item invokes the macro defined by `strMacro`. See also [Example Scripting Project](#) ¹¹⁰⁴.

Errors

| | |
|------|--|
| 1111 | The application object is no longer valid. |
| 1100 | Invalid parameter or invalid address for the return parameter was specified. |
| 1108 | Number of macro items is limited to 16 items. |

26.3.2.1.4 AddXSLT_XQParameter

Method: `AddXSLT_XQParameter(name as String, XPath as String)`

Description

Adds an XSLT or XQuery parameter. The parameter's name and value are the two arguments of the method.

Errors

| | |
|------|---|
| 1111 | The application object is no longer valid. |
| 1100 | Invalid address for the return parameter was specified. |
| 1124 | The XPath expression is not set. |
| 1125 | Not a QName. |
| 1126 | The specified XPath is not valid. Reason for invalidity appended. |
| 1127 | A parameter with the submitted name already exists. |

26.3.2.1.5 Application

Property: `Application` as [Application](#) ¹¹⁷² (read-only)

Description

Accesses the XMLSpy application object.

Errors

| | |
|------|---|
| 1111 | The application object is no longer valid. |
| 1100 | Invalid address for the return parameter was specified. |

26.3.2.1.6 ClearMacroMenu

Method: ClearMacroMenu()

Return Value

None

Description

Removes from the **Tools** menu those menu items that were added by calling [AddMacroMenuItem](#)¹¹⁷⁶. See also [Example Scripting Project](#)¹¹⁰⁴.

Errors

| | |
|------|--|
| 1111 | The application object is no longer valid. |
|------|--|

26.3.2.1.7 CreateXMLSchemaFromDBStructure

Method: CreateXMLSchemaFromDBStructure(pImportSettings as [DatabaseConnection](#)¹²⁵⁴, pTables as [ElementList](#)¹³⁰³)

Description

CreateXMLSchemaFromDBStructure creates from a database specified in pImportSettings for the defined tables in pTables new XML Schema document(s) describing the database tables structure.

The parameter pTables specifies which table structures the XML Schema document should contain. This parameter can be NULL, specifying that all table structures will be exported.

See also [GetDataBaseTables](#)¹¹⁸⁰.

Errors

| | |
|------|-----------------------------|
| 1112 | Invalid database specified. |
| 1120 | Database import failed. |

26.3.2.1.8 CurrentProject

Property: CurrentProject as [SpyProject](#)¹³⁵⁹

Description

Reference to the active document. If no project is open, CurrentProject is null (nothing).

Errors

| | |
|------|---|
| 1111 | The application object is no longer valid. |
| 1100 | Invalid address for the return parameter was specified. |

26.3.2.1.9 Dialogs

Property: Dialogs as [Dialogs](#)¹²⁶¹ (read-only)

Description

Access the built-in dialogs of XMLSpy.

Errors

| | |
|------|---|
| 1111 | The application object is no longer valid. |
| 1100 | Invalid address for the return parameter was specified. |

26.3.2.1.10 Documents

Property: Documents as [Documents](#)¹²⁹⁵

Description

Collection of all open documents.

Errors

| | |
|------|---|
| 1111 | The application object is no longer valid. |
| 1100 | Invalid address for the return parameter was specified. |

26.3.2.1.11 Edition

Property: Edition as String

Description

Returns the edition of the application, for example `Altova XMLSpy Enterprise Edition for the Enterprise edition`.

Errors

| | |
|------|---|
| 1111 | The application object is no longer valid. |
| 1100 | Invalid address for the return parameter was specified. |

26.3.2.1.12 FindInFiles

Method: FindInFiles(*pSettings* as [FindInFilesDlg](#)¹³¹⁰) as [FindInFilesResults](#)¹³²¹

Description

Returns a [FindInFilesResults](#)¹³²¹ object containing information about the files that matched the specified settings.

Errors

| | |
|------|---|
| 1111 | The application object is no longer valid. |
| 1100 | Invalid address for the return parameter was specified. |

26.3.2.1.13 GetDatabaseImportElementList

Method: GetDatabaseImportElementList(*pImportSettings* as [DatabaseConnection](#)¹²⁵⁴) as [ElementList](#)¹³⁰⁴

Description

The function returns a collection of [ElementListItem](#)s where the properties [ElementListItem.Name](#)¹³⁰⁵ contain the names of the fields that can be selected for import and the properties [ElementListItem.ElementKind](#)¹³⁰⁵ are initialized either to *spyXMLDataAttr* or *spyXMLDataElement*, depending on the value passed in [DatabaseConnection.AsAttributes](#)¹²⁵⁶. This list serves as a filter to what finally gets imported by a future call to [ImportFromDatabase](#)¹¹⁸³. Use [ElementList.RemoveElement](#)¹³⁰⁴ to exclude fields from import.

Properties mandatory to be filled out for the database connection are one of [DatabaseConnection.File](#)¹²⁵⁷, [DatabaseConnection.ADOConnection](#)¹²⁵⁵ and [DatabaseConnection.ODBCConnection](#)¹²⁵⁹, as well as [DatabaseConnection.SQLSelect](#)¹²⁶⁰. Use the property [DatabaseConnection.AsAttributes](#)¹²⁵⁶ to initialize [ElementListItem.ElementKind](#)¹³⁰⁵ of the resulting element list to either *spyXMLDataAttr* or *spyXMLDataElement*, respectively.

Example

See example at [ImportFromDatabase](#)¹¹⁸³.

Errors

| | |
|------|--|
| 1111 | The application object is no longer valid. |
| 1100 | Invalid parameter or invalid address for the return parameter was specified. |
| 1107 | Import from database failed. |
| 1112 | Invalid database specified. |
| 1114 | Select statement is missing. |
| 1119 | database element list import failed. |

26.3.2.1.14 GetDatabaseSettings

Method: GetDatabaseSettings() as [DatabaseConnection](#)¹²⁵⁴

Description

GetDatabaseSettings creates a new object of database settings. The object is used to specify database connection parameters for the methods [GetDatabaseTables](#) ⁽¹¹⁸⁰⁾, [GetDatabaseImportElementList](#) ⁽¹¹⁷⁹⁾, [ImportFromDatabase](#) ⁽¹¹⁸³⁾, [ImportFromSchema](#) ⁽¹¹⁸⁴⁾ and [ExportToDatabase](#) ⁽¹²⁷⁷⁾.

Example

See example of [ImportFromDatabase](#) ⁽¹¹⁸³⁾.

Errors

| | |
|------|---|
| 1111 | The application object is no longer valid. |
| 1100 | Invalid address for the return parameter was specified. |

26.3.2.1.15 GetDatabaseTables

Method: GetDatabaseTables(*pImportSettings* as [DatabaseConnection](#) ⁽¹¹⁷²⁾) as [ElementList](#) ⁽¹³⁰⁴⁾

Description

GetDatabaseTables reads the table names from the database specified in *pImportSettings*. Properties mandatory to be filled out for the database connection are one of [DatabaseConnection.File](#) ⁽¹²⁵⁷⁾, [DatabaseConnection.ADOConnection](#) ⁽¹²⁵⁵⁾ and [DatabaseConnection.ODBCConnection](#) ⁽¹²⁵⁹⁾. All other properties are ignored.

The function returns a collection of [ElementListItem](#)s where the properties [ElementListItem.Name](#) ⁽¹³⁰⁵⁾ contain the names of tables stored in the specified database. The remaining properties of [ElementListItem](#) ⁽¹³⁰⁵⁾ are unused.

Errors

| | |
|------|--|
| 1111 | The application object is no longer valid. |
| 1100 | Invalid parameter or invalid address for the return parameter was specified. |
| 1112 | Invalid database specified. |
| 1113 | Error while reading database table information. |
| 1118 | Database table query failed. |

Example

```

Dim objImpSettings As DatabaseConnection
Set objImpSettings = objSpy.GetDatabaseSettings
objImpSettings.ADOConnection = TxtADO.Text

'store table names in list box
ListTables.Clear

Dim objList As ElementList
Dim objItem As ElementListItem
On Error GoTo ErrorHandler
Set objList = objSpy.GetDatabaseTables(objImpSettings)

For Each objItem In objList
    ListTables.AddItem objItem.Name

```

Next

26.3.2.1.16 GetExportSettings

Method: GetExportSettings() as [ExportSettings](#)¹³⁰⁶ (read-only)

Description

GetExportSettings creates a new object of common export settings. This object is used to pass the parameters to the export functions and defines the behaviour of the export calls. See also the export functions from [Document](#)¹²⁶⁴ and the examples at [Import and Export](#)¹¹⁴².

Errors

| | |
|------|---|
| 1111 | The application object is no longer valid. |
| 1100 | Invalid address for the return parameter was specified. |

26.3.2.1.17 GetTextImportElementList

Method: GetTextImportElementList(pImportSettings as [TextImportExportSettings](#)¹³⁶⁵) as [ElementList](#)¹³⁰⁴

Description

GetTextImportElementList retrieves importing information about the text-file as specified in pImportSettings. The function returns a collection of ElementListItem where the properties [ElementListItem.Name](#)¹³⁰⁵ contain the names of the fields found in the file. The values of remaining properties are undefined.

If the text-file does not contain a column header, set pImportSettings.[HeaderRow](#)¹³⁶⁶ to false. The resulting element list will contain general column names like 'Field1' and so on.

See also [Import and export of data](#)¹¹⁴².

Errors

| | |
|------|--|
| 1111 | The application object is no longer valid. |
| 1100 | Invalid parameter or invalid address for the return parameter was specified. |
| 1107 | Import from database failed. |
| 1115 | Error during text element list import. Cannot create parser for import file. |
| 1116 | Error during text element list import. |

Example

```
'
'-----
' VBA client code fragment - import selected fields from text file
'-----
    Dim objImpSettings As TextImportExportSettings
    Set objImpSettings = objSpy.GetTextImportExportSettings

    objImpSettings.ImportFile = "C:\ImportMe.txt"
    objImpSettings.HeaderRow = False
```

```
Dim objList As ElementList
Set objList = objSpy.GetTextImportElementList(objImpSettings)
```

```
'exclude first column
objList.RemoveItem 1
```

```
Dim objImpDoc As Document
On Error Resume Next
Set objImpDoc = objSpy.ImportFromText(objImpSettings, objList)
CheckForError
```

26.3.2.1.18 GetTextImportExportSettings

Method: GetTextImportExportSettings() as [TextImportExportSettings](#)¹³⁶⁵ (read-only)

Description

GetTextImportExportSettings creates a new object of common import and export settings for text files. See also the example for [Application.GetTextImportElementList](#)¹¹⁸¹ and [Import and Export](#)¹¹⁴².

Errors

| | |
|------|---|
| 1111 | The application object is no longer valid. |
| 1100 | Invalid address for the return parameter was specified. |

26.3.2.1.19 GetXSLT_XQParameterCount

Method: GetXSLT_XQParameterCount() as Long

Description

Returns the number of XSLT and XQuery parameters.

Errors

| | |
|------|---|
| 1111 | The application object is no longer valid. |
| 1100 | Invalid address for the return parameter was specified. |

26.3.2.1.20 GetXSLT_XQParameterName

Method: GetXSLT_XQParameterName(index as Long) as String

Description

Returns the name of the XSLT or XQuery parameter identified by the supplied index.

Errors

| | |
|------|---|
| 1111 | The application object is no longer valid. |
| 1100 | Invalid address for the return parameter was specified. |

26.3.2.1.21 GetXSLT_XQParameterXPath

Method: GetXSLT_XQParameterXPath(index as Long) as String

Description

Returns the XPath expression of the XSLT or XQuery parameter identified by the supplied index.

Errors

| | |
|------|---|
| 1111 | The application object is no longer valid. |
| 1100 | Invalid address for the return parameter was specified. |

26.3.2.1.22 ImportFromDatabase

Method: ImportFromDatabase(plmportSettings as [DatabaseConnection](#)¹²⁵⁴, pElementList as [ElementList](#)¹³⁰⁴) as [Document](#)¹²⁶⁴

Return Value

Creates a new document containing the data imported from the database.

Description

ImportFromDatabase imports data from a database as specified in plmportSettings and creates a new document containing the data imported from the database. Properties mandatory to be filled out are one of [DatabaseConnection.File](#)¹²⁵⁷, [DatabaseConnection.ADOConnection](#)¹²⁵⁵ or [DatabaseConnection.ODBCConnection](#)¹²⁵⁹ and [DatabaseConnection.SQLSelect](#)¹²⁶⁰. Additionally, you can use [DatabaseConnection.AsAttributes](#)¹²⁵⁶, [DatabaseConnection.ExcludeKeys](#)¹²⁵⁷, [DatabaseConnection.IncludeEmptyElements](#)¹²⁵⁸ and [NumberDateTimeFormat](#)¹²⁵⁹ to further parameterize import.

The parameter pElementList specifies which fields of the selected data gets written into the newly created document, and which are created as elements and which as attributes. This parameter can be NULL, specifying that all selected fields will be imported as XML elements.

See [GetDatabaseSettings](#)¹¹⁷⁶ and [GetDatabaseImportElementList](#)¹¹⁷⁹ for necessary steps preceding any import of data from a database.

Errors

| | |
|------|--|
| 1111 | The application object is no longer valid. |
| 1100 | Invalid parameter or invalid address for the return parameter was specified. |
| 1107 | Import from database failed. |
| 1112 | Invalid database specified. |

| | |
|------|-------------------------------|
| 1114 | Select statement is missing. |
| 1117 | Transformation to XML failed. |
| 1120 | Database import failed. |

Example

```
Dim objImpSettings As DatabaseConnection
Set objImpSettings = objSpy.GetDatabaseSettings

objImpSettings.ADOConnection = strADOConnection
objImpSettings.SQLSelect = "SELECT * FROM MyTable"

Dim objDoc As Document
On Error Resume Next
Set objDoc = objSpy.ImportFromDatabase(objImpSettings,
objSpy.GetDatabaseImportElementList(objImpSettings))
' CheckForError here
```

26.3.2.1.23 ImportFromSchema

Method: `ImportFromSchema(pImportSettings as DatabaseConnection1254, strTable as String, pSchemaDoc as Document1263) as Document1264`

Return Value

Creates a new document filled with data from the specified database as specified by the schema definition in *pSchemaDoc*.

Description

`ImportFromSchema` imports data from a database specified in `pImportSettings`. Properties mandatory to be filled out are one of `DatabaseConnection.File1257`, `DatabaseConnection.ADOConnection1255` or `DatabaseConnection.ODBCConnection1259`. Additionally, you can use `DatabaseConnection.AsAttributes1256`, `DatabaseConnection.ExcludeKeys1257` and `NumberDateTimeFormat1259` to further parameterize import. All other properties get ignored.

`ImportFromSchema` does not use an explicit SQL statement to select the data. Instead, it expects a structure definition of the document to create in form of an XML schema document in *pSchemaDoc*. From this definition the database select statement is automatically deduced. Specify in *strTable* the table name of the import root that will become the root node in the new document.

See `GetDatabaseSettings1179` and `GetDatabaseTables1180` for necessary steps preceding an import from a database based on a schema definition. To create the schema definition file use command 'create database schema' from the 'convert' menu of XMLSpy.

Errors

| | |
|------|--|
| 1111 | The application object is no longer valid. |
| 1100 | Invalid parameter or invalid address for the return parameter was specified. |
| 1107 | Import from database failed. |
| 1112 | Invalid database specified. |

| | |
|------|--|
| 1120 | Database import failed. |
| 1121 | Could not create validator for the specified schema. |
| 1122 | Failed parsing schema for database import. |

26.3.2.1.24 ImportFromText

Method: ImportFromText(*pImportSettings* as [TextImportExportSettings](#)¹³⁶⁵, *pElementList* as [ElementList](#)¹³⁰⁴) as [Document](#)¹²⁶⁴

Description

ImportFromText imports the text file as specified in *pImportSettings*. The parameter *pElementList* can be used as import filter. Either pass the list returned by a previous call to [GetTextImportElementList](#)¹¹⁸¹ or null to import all columns. To avoid import of unnecessary columns use [ElementList.RemoveElement](#)¹³⁰⁴ to remove the corresponding field names from *pElementList* before calling *ImportFromText*. The method returns the newly created document containing the imported data. This document is the same as the active document of XMLSpy.

See also [Import and export of data](#)¹¹⁴².

Errors

| | |
|------|--|
| 1111 | The application object is no longer valid. |
| 1100 | Invalid parameter or invalid address for the return parameter was specified. |
| 1107 | Import from text file failed. |
| 1117 | Transformation to XML failed. |

Example

```
'-----
' VBA client code fragment - import from text file
'-----
    Dim objImpSettings As TextImportExportSettings
    Set objImpSettings = objSpy.GetTextImportExportSettings

    objImpSettings.ImportFile = strFileName
    objImpSettings.HeaderRow = False

    Dim objImpDoc As Document
    On Error Resume Next
    Set objImpDoc = objSpy.ImportFromText(objImpSettings,
objSpy.GetTextImportElementList(objImpSettings))

    CheckForError
```

26.3.2.1.25 ImportFromWord

Method: ImportFromWord(*strFile* as String) as [Document](#)¹²⁶⁴

Description

ImportFromWord imports the MS-Word Document strFile into a new XML document.

Errors

| | |
|------|--|
| 1111 | The application object is no longer valid. |
| 1100 | Invalid parameter or invalid address for the return parameter was specified.
Import from document failed. |

26.3.2.1.26 IsAPISupported

Property: IsAPISupported as Boolean

Description

Returns whether the API is supported in this version or not.

Errors

| | |
|------|---|
| 1111 | The application object is no longer valid. |
| 1100 | Invalid address for the return parameter was specified. |

26.3.2.1.27 MajorVersion

Property: MajorVersion as Integer

Description

Returns the application version's major number, for example 15 for 2013 versions, and 16 for 2014 versions..

Errors

| | |
|------|---|
| 1111 | The application object is no longer valid. |
| 1100 | Invalid address for the return parameter was specified. |

26.3.2.1.28 MinorVersion

Property: MinorVersion as Integer

Description

Returns the application version's minor number.

Errors

| | |
|------|---|
| 1111 | The application object is no longer valid. |
| 1100 | Invalid address for the return parameter was specified. |

26.3.2.1.29 NewProject

Method: NewProject(*strPath* as String,*bDiscardCurrent* as Boolean)

Description

NewProject creates a new project.

If there is already a project open that has been modified and *bDiscardCurrent* is false, then NewProject() fails.

Errors

| | |
|------|---|
| 1111 | The application object is no longer valid. |
| 1102 | A project is already open but <i>bDiscardCurrent</i> is true. |
| 1103 | Creation of new project failed. |

26.3.2.1.30 OpenProject

Method: OpenProject(*strPath* as String,*bDiscardCurrent* as Boolean,*bDialog* as Boolean)

Parameters

strPath

Path and file name of the project to open. Can be empty if *bDialog* is true.

bDiscardCurrent

Discard currently open project and possibly lose changes.

bDialog

Show dialogs for user input.

Return Value

None

Description

OpenProject opens an existing project. If there is already a project open that has been modified and *bDiscardCurrent* is false, then OpenProject() fails.

Errors

| | |
|------|--|
| 1111 | The application object is no longer valid. |
| 1100 | Invalid parameter or invalid address for the return parameter was specified. |
| 1101 | Cannot open specified project. |
| 1102 | A project is already open but <i>bDiscardCurrent</i> is true. |

26.3.2.1.31 Parent

Property: Parent as [Application](#)¹¹⁷² (read-only)

Description

Accesses the XMLSpy application object.

Errors

| | |
|------|---|
| 1111 | The application object is no longer valid. |
| 1100 | Invalid address for the return parameter was specified. |

26.3.2.1.32 Quit

Method: Quit()

Return Value

None

Description

This method terminates XMLSpy. All modified documents will be closed without saving the changes. This is also true for an open project.

If XMLSpy was automatically started as an automation server by a client program, the application will not shut down automatically when your client program shuts down if a project or any document is still open. Use the Quit method to ensure automatic shut-down.

Errors

| | |
|------|--|
| 1111 | The application object is no longer valid. |
|------|--|

26.3.2.1.33 ReloadSettings

Method: ReloadSettings

Return Value

Description

The application settings are reloaded from the registry.

Available with TypeLibrary version 1.5

Errors

| | |
|------|--|
| 1111 | The application object is no longer valid. |
|------|--|

26.3.2.1.34 RemoveXSLT_XQParameter

Method: RemoveXSLT_XQParameter(index as Long)

Description

Removes the XSLT or XQuery parameter identified by the supplied index.

Errors

| | |
|------|---|
| 1111 | The application object is no longer valid. |
| 1100 | Invalid address for the return parameter was specified. |

26.3.2.1.35 RunMacro

Method: RunMacro(strMacro as String)

Return Value

Description

Calls the specified macro either from the project scripts (if present) or from the global scripts.

Available with TypeLibrary version 1.5

Errors

| | |
|------|--|
| 1111 | The application object is no longer valid. |
|------|--|

26.3.2.1.36 ScriptingEnvironment

Property: ScriptingEnvironment as IUnknown (read-only)

Description

Reference to any active scripting environment. This property makes it possible to access the TypeLibrary of the XMLSpyFormEditor.exe application which is used as the current scripting environment.

Available with TypeLibrary version 1.5

Errors

| | |
|------|---|
| 1111 | The application object is no longer valid. |
| 1100 | Invalid address for the return parameter was specified. |

26.3.2.1.37 ServicePackVersion

Property: ServicePackVersion as Long

Description

Returns the Service Pack version number of the application. Eg: 1 for 2010 R2 SP1

Errors

| | |
|------|---|
| 1111 | The application object is no longer valid. |
| 1100 | Invalid address for the return parameter was specified. |

26.3.2.1.38 ShowApplication

Method: ShowApplication(*bShow* as Boolean)

Return Value

None

Description

The method shows (*bShow* = True) or hides (*bShow* = False) XMLSpy.

Errors

| | |
|------|--|
| 1110 | The application object is no longer valid. |
|------|--|

26.3.2.1.39 ShowFindInFiles

Method: ShowFindInFiles(*pSettings* as [FindInFilesDlg](#)¹³¹⁰) as Boolean

Return Value

Returns false if the user pressed the Cancel button, true otherwise.

Description

Displays the FindInFiles dialog preset with the given settings. The user modifications of the settings are stored in the passed dialog object.

Errors

| | |
|------|--|
| 1111 | The application object is no longer valid. |
| 1100 | Invalid parameter or invalid address for the return parameter was specified. |

26.3.2.1.40 ShowForm

Method: ShowForm(*strFormName* as String) as Long

Return Value

Returns zero if the user pressed a Cancel button or the form calls TheView.Cancel().

Description

Displays the form *strFormName*.

Forms, event handlers and macros can be created with the Scripting Environment. Select "Switch to scripting environment" from the **Tools** menu to invoke the Scripting Environment.

Errors

| | |
|------|--|
| 1111 | The application object is no longer valid. |
| 1100 | Invalid parameter or invalid address for the return parameter was specified. |

26.3.2.1.41 Status

Property: Status as [ENUMApplicationStatus](#)¹⁴²²

Description

Returns the current status of the running application.

Errors

| | |
|------|---|
| 1111 | The application object is no longer valid. |
| 1100 | Invalid address for the return parameter was specified. |

26.3.2.1.42 URLDelete

Method: URLDelete(*strURL* as String,*strUser* as String,*strPassword* as String)

Return Value

None

Description

The method deletes the file at the URL *strURL*.

Errors

| | |
|------|--|
| 1111 | The application object is no longer valid. |
| 1109 | Error deleting file at specified URL. |

26.3.2.1.43 URLMakeDirectory

Method: URLMakeDirectory(*strURL* as String,*strUser* as String,*strPassword* as String)

Return Value

None

Description

The method creates a new directory at the URL *strURL*.

Errors

| | |
|------|--|
| 1111 | The application object is no longer valid. |
| 1100 | Invalid parameter specified. |

26.3.2.1.44 Visible

Property: Visible as VARIANT_BOOL

Description

Sets or gets the visibility attribute of XMLSpy. This standard automation property makes usage of [ShowApplication](#) ¹¹⁹⁰ obsolete.

Errors

| | |
|------|---|
| 1110 | The application object is no longer valid. |
| 1100 | Invalid address for the return parameter was specified. |

26.3.2.1.45 WarningNumber

Property: WarningNumber as integer

Description

Some methods fill the property WarningNumber with additional information if an error occurs.

Currently just [Documents.OpenFile](#) ¹²⁹⁸ fills this property.

Errors

| | |
|------|---|
| 1111 | The application object is no longer valid. |
| 1100 | Invalid address for the return parameter was specified. |

26.3.2.1.46 WarningText

Property: WarningText as String

Description

Some methods fill the property WarningText with additional information if an error occurs.

Currently just [Documents.OpenFile](#) ¹²⁹⁸ fills this property.

Errors

| | |
|------|---|
| 1111 | The application object is no longer valid. |
| 1100 | Invalid address for the return parameter was specified. |

26.3.2.2 AuthenticContextMenu

The context menu interface provides the means for the user to customize the context menus shown in Authentic. The interface has the methods listed in this section.

26.3.2.2.1 CountItems

Method: CountItems () nItems as long

Return Value

Returns the number of menu items.

Errors

| | |
|------|-----------------|
| 2501 | Invalid object. |
|------|-----------------|

26.3.2.2.2 DeleteItem

Method: DeleteItem (IndexPosition as long)

Return Value

Deletes the menu item that has the index position submitted in the first parameter.

Errors

| | |
|------|----------------|
| 2501 | Invalid object |
| 2502 | Invalid index |

26.3.2.2.3 GetItemText

Method: GetItemText (IndexPosition as long) MenuItemName as string

Return Value

Gets the name of the menu item located at the index position submitted in the first parameter.

Errors

| | |
|------|----------------|
| 2501 | Invalid object |
| 2502 | Invalid index |

26.3.2.2.4 InsertItem

Method: InsertItem (IndexPosition as long, MenuItemName as string, MacroName as string)

Return Value

Inserts a user-defined menu item at the position in the menu specified in the first parameter and having the name submitted in the second parameter. The menu item will start a macro, so a valid macro name must be submitted.

Errors

| | |
|------|----------------|
| 2501 | Invalid object |
| 2502 | Invalid index |
| 2503 | No such macro |
| 2504 | Internal error |

26.3.2.2.5 SetItemText

Method: `SetItemText(IndexPosition as long, MenuItemName as string)`

Return Value

Sets the name of the menu item located at the index position submitted in the first parameter.

Errors

| | |
|------|----------------|
| 2501 | Invalid object |
| 2502 | Invalid index |

26.3.2.3 AuthenticDataTransfer

Renamed from DocEditDataTransfer to AuthenticDataTransfer

The DocEditView object is renamed to OldAuthenticView.
 DocEditSelection is renamed to AuthenticSelection.
 DocEditEvent is renamed to AuthenticEvent.
 DocEditDataTransfer is renamed to AuthenticDataTransfer.

Their usage—except for AuthenticDataTransfer—is no longer recommended. We will continue to support existing functionality for a yet undefined period of time but no new features will be added to these interfaces. All functionality available up to now in [DocEditView](#)¹⁴⁰⁰, [DocEditSelection](#)¹³⁹⁸, [DocEditEvent](#)¹³⁸⁵ and [DocEditDataTransfer](#)¹¹⁹⁵ is now available via [AuthenticView](#)¹²²⁹, [AuthenticRange](#)¹¹⁹⁹ and [AuthenticDataTransfer](#)¹¹⁹⁴. Many new features have been added.

For examples on migrating from DocEdit to Authentic see the description of the different methods and properties of the different DocEdit objects.

Methods

[getData](#)¹¹⁹⁵

Properties

[dropEffect](#)¹¹⁹⁵
[ownDrag](#)¹¹⁹⁵
[type](#)¹¹⁹⁶

Description

The events OnDragOver and OnBeforeDrop provide information about the object being dragged with an instance of type AuthenticDataTransfer. It contains a description of the dragged object and its content. The latter is available either as string or a pointer to a COM object supporting the IUnkown interface.

26.3.2.3.1 [dropEffect](#)

Property: dropEffect as long

Description

The property stores the drop effect from the default event handler. You can set the drop effect if you change this value and return TRUE for the event handler (or set [AuthenticEvent.cancelBubble](#)¹³⁸⁹ to TRUE if you are still using the now obsolete AuthenticEvent interface).

Errors

| | |
|------|---|
| 2101 | Invalid address for the return parameter was specified. |
|------|---|

26.3.2.3.2 [getData](#)

Method: getData() as Variant

Description

Retrieve the data associated with the dragged object. Depending on [AuthenticDataTransfer.type](#)¹¹⁹⁶, that data is either a string or a COM interface pointer of type IUnknown.

Errors

| | |
|------|---|
| 2101 | Invalid address for the return parameter was specified. |
|------|---|

26.3.2.3.3 [ownDrag](#)

Property: ownDrag as Boolean (read-only)

Description

The property is TRUE if the current dragging source comes from inside Authentic View.

Errors

| | |
|------|---|
| 2101 | Invalid address for the return parameter was specified. |
|------|---|

26.3.2.3.4 type

Property: type as String (read-only)

Description

Holds the type of data you get with the [DocEditDataTransfer.getData](#)¹¹⁹⁵ method.

Currently supported data types are:

| | |
|-------------|---------------------------------|
| OWN | data from Authentic View itself |
| TEXT | plain text |
| UNICODETEXT | plain text as UNICODE |

Errors

| | |
|------|---|
| 2101 | Invalid address for the return parameter was specified. |
|------|---|

26.3.2.4 AuthenticEventContext

The `EventContext` interface gives access to many properties of the context in which a macro is executed.

26.3.2.4.1 EvaluateXPath

Method: EvaluateXPath (strExpression as string) as strValue as string

Return Value

The method evaluates the XPath expression in the context of the node within which the event was triggered and returns a string.

Description

`EvaluateXPath()` executes an XPath expression with the given event context. The result is returned as a string, in the case of a sequence it is a space-separated string.

Errors

| | |
|------|--------------------|
| 2201 | Invalid object. |
| 2202 | No context. |
| 2209 | Invalid parameter. |
| 2210 | Internal error. |
| 2211 | XPath error. |

26.3.2.4.2 GetEventContextType

Method: `GetEventContextType ()` Type as `AuthenticEventContextType` enumeration

Return Value

Returns the context node type.

Description

`GetEventContextType` allows the user to determine whether the macro is in an XML node or in an XPath atomic item context. The enumeration `AuthenticEventContextType` is defined as follows:

`authenticEventContextXML`,
`authenticEventContextAtomicItem`,
`authenticEventContextOther`

If the context is a normal XML node, the `GetXMLNode ()` function gives access to it (returns `NULL` if not).

Errors

| | |
|------|--------------------|
| 2201 | Invalid object. |
| 2202 | No context. |
| 2209 | Invalid parameter. |

26.3.2.4.3 GetNormalizedTextValue

Method: `GetNormalizedTextValue ()` `strValue` as string

Return Value

Returns the value of the current node as string

Errors

| | |
|------|--------------------|
| 2201 | Invalid object. |
| 2202 | No context. |
| 2203 | Invalid context |
| 2209 | Invalid parameter. |

26.3.2.4.4 GetVariableValue

Method: `GetVariableValue (strName as string)` `strValue` as string

Return Value

Gets the value of the variable submitted as the parameter.

Description

`GetVariableValue` gets the variable's value in the scope of the context.

```
nZoom = parseInt( AuthenticView.EventContext.GetVariableValue( 'Zoom' ) );
if ( nZoom > 1 )
{
    AuthenticView.EventContext.SetVariableValue( 'Zoom', nZoom - 1 );
}
```

Errors

| | |
|------|------------------------------|
| 2201 | Invalid object. |
| 2202 | No context. |
| 2204 | No such variable in scope |
| 2205 | Variable cannot be evaluated |
| 2206 | Variable returns sequence |
| 2209 | Invalid parameter |

26.3.2.4.5 GetXMLNode

Method: `GetXMLNode()` Node as `XMLData` object

Return Value

Returns the context XML node or `NULL`

Errors

| | |
|------|--------------------|
| 2201 | Invalid object. |
| 2202 | No context. |
| 2203 | Invalid context |
| 2209 | Invalid parameter. |

26.3.2.4.6 IsAvailable

Method: `IsAvailable()` as Boolean

Return Value

Returns true if `EventContext` is set, false otherwise.

Errors

| | |
|------|-----------------|
| 2201 | Invalid object. |
|------|-----------------|

26.3.2.4.7 SetVariableValue

Method: SetVariableValue(strName as string, strValue as string)

Return Value

Sets the value (second parameter) of the variable submitted in the first parameter.

Description

SetVariableValue sets the variable's value in the scope of the context.

```
nZoom = parseInt( AuthenticView.EventContext.GetVariableValue( 'Zoom' ) );
if ( nZoom > 1 )
{
    AuthenticView.EventContext.SetVariableValue( 'Zoom', nZoom - 1 );
}
```

Errors

| | |
|------|------------------------------|
| 2201 | Invalid object. |
| 2202 | No context. |
| 2204 | No such variable in scope |
| 2205 | Variable cannot be evaluated |
| 2206 | Variable returns sequence |
| 2207 | Variable read-only |
| 2208 | No modification allowed |

26.3.2.5 AuthenticRange

The first table lists the properties and methods of AuthenticRange that can be used to navigate through the document and select specific portions.

| Properties | Methods | |
|--|--|--|
| Application ¹²⁰² | Clone ¹²⁰³ | MoveBegin ¹²²² |
| FirstTextPosition ¹²⁰⁶ | CollapsToBegin ¹²⁰³ | MoveEnd ¹²²² |
| FirstXMLData ¹²⁰⁷ | CollapsToEnd ¹²⁰³ | NextCursorPosition ¹²¹³ |
| FirstXMLDataOffset ¹²⁰⁸ | ExpandTo ¹²⁰⁶ | PreviousCursorPosition ¹²¹⁴ |
| LastTextPosition ¹²¹⁹ | Goto ¹²¹² | Select ¹²²⁵ |
| LastXMLData ¹²²⁰ | GotoNext ¹²¹² | SelectNext ¹²²⁵ |
| LastXMLDataOffset ¹²²¹ | GotoPrevious ¹²¹⁴ | SelectPrevious ¹²²⁶ |
| Parent ¹²²³ | IsEmpty ¹²¹⁷ | SetFromRange ¹²²⁸ |

| | | |
|--|---|--|
| | IsEqual ¹²¹⁷ | |
|--|---|--|

The following table lists the content modification methods, most of which can be found on the right/button mouse menu.

| Properties | Edit operations | Dynamic table operations |
|--------------------------------------|---|--|
| Text ¹²²⁸ | Copy ¹²⁰⁴ | AppendRow ¹²⁰¹ |
| | Cut ¹²⁰⁴ | DeleteRow ¹²⁰⁵ |
| | Delete ¹²⁰⁴ | DuplicateRow ¹²⁰⁵ |
| | IsCopyEnabled ¹²¹⁶ | InsertRow ¹²¹⁶ |
| | IsCutEnabled ¹²¹⁷ | IsFirstRow ¹²¹⁸ |
| | IsDeleteEnabled ¹²¹⁷ | IsInDynamicTable ¹²¹⁸ |
| | IsPasteEnabled ¹²¹⁸ | IsLastRow ¹²¹⁸ |
| | Paste ¹²²³ | MoveRowDown ¹²²³ |
| | | MoveRowUp ¹²²³ |

The following methods provide the functionality of the Authentic entry helper windows for range objects.

| Operations of the entry helper windows | | |
|--|--|--|
| Elements | Attributes | Entities |
| CanPerformActionWith ¹²⁰² | GetElementAttributeValue ¹²¹⁰ | GetEntityNames ¹²¹¹ |
| CanPerformAction ¹²⁰² | GetElementAttributeNames ¹²⁰⁹ | InsertEntity ¹²¹⁵ |
| PerformAction ¹²²⁴ | GetElementHierarchy ¹²¹⁰ | |
| | HasElementAttribute ¹²¹⁵ | |
| | IsTextStateApplied ¹²¹⁹ | |
| | SetElementAttributeValue ¹²²⁷ | |

Description

AuthenticRange objects are the 'cursor' selections of the automation interface. You can use them to point to any cursor position in the Authentic view, or select a portion of the document. The operations available for AuthenticRange objects then work on this selection in the same way, as the corresponding operations of the user interface do with the current user interface selection. The main difference is that you can use an arbitrary number of AuthenticRange objects at the same time, whereas there is exactly one cursor selection in the user interface.

To get to an initial range object use [AuthenticView.Selection](#)¹²⁴⁶, to obtain a range corresponding with the current cursor selection in the user interface. Alternatively, some trivial ranges are accessible via the read/only properties [AuthenticView.DocumentBegin](#)¹²⁴¹, [AuthenticView.DocumentEnd](#)¹²⁴¹, and

[AuthenticView.WholeDocument](#)¹²⁴⁸. The most flexible method is [AuthenticView.Goto](#)¹²⁴³, which allows navigation to a specific portion of the document within one call. For more complex selections, combine the above with the various navigation methods on range objects listed in the first table on this page.

Another method to select a portion of the document is to use the position properties of the range object. Two positioning systems are available and can be combined arbitrarily:

- **Absolute** text cursor positions, starting with position 0 at the document beginning, can be set and retrieved for the beginning and end of a range. For more information see [FirstTextPosition](#)¹²⁰⁶ and [LastTextPosition](#)¹²¹⁹. This method requires complex internal calculations and should be used with care.
- The **XMLData** element and a text position inside this element, can be set and retrieved for the beginning and end of a range. For more information see [FirstXMLData](#)¹²⁰⁷, [FirstXMLDataOffset](#)¹²⁰⁸, [LastXMLData](#)¹²²⁰, and [LastXMLDataOffset](#)¹²²¹. This method is very efficient but requires knowledge of the underlying document structure. It can be used to locate XMLData objects and perform operations on them otherwise not accessible through the user interface.

Modifications to the document content can be achieved by various methods:

- The [Text](#)¹²²⁸ property allows you to retrieve the document text selected by the range object. If set, the selected document text gets replaced with the new text.
- The standard document edit functions [Cut](#)¹²⁰⁴, [Copy](#)¹²⁰⁴, [Paste](#)¹²²³ and [Delete](#)¹²⁰⁴.
- Table operations for tables that can grow dynamically.
- Methods that map the functionality of the Authentic entry helper windows.
- Access to the [XMLData](#)¹³⁷³ objects of the underlying document to modify them directly.

26.3.2.5.1 AppendRow

Method: AppendRow()as Boolean

Description

If the beginning of the range is inside a dynamic table, this method inserts a new row at the end of the selected table. The selection of the range is modified to point to the beginning of the new row. The function returns *true* if the append operation was successful, otherwise *false*.

Errors

| | |
|------|---|
| 2001 | The authentic range object or its related view object is no longer valid. |
| 2005 | Invalid address for the return parameter was specified. |

Examples

```
' -----
' Scripting environment - VBScript
' Append row at end of current dynamically growable table
' -----

Dim objRange
' we assume that the active document is open in authentic view mode
Set objRange = Application.ActiveDocument.AuthenticView.Selection
```

```
' check if we can insert something
If objRange.IsInDynamicTable Then
    objRange.AppendRow
    ' objRange points to beginning of new row
    objRange.Select
End If
```

26.3.2.5.2 Application

Property: Application as [Application](#)¹¹⁷² (read-only)

Description

Accesses the XMLSpy application object.

Errors

| | |
|------|---|
| 2001 | The authentic range object or its related view object is no longer valid. |
| 2005 | Invalid address for the return parameter was specified. |

26.3.2.5.3 CanPerformAction

Method: CanPerformAction (*eAction* as [SPYAuthenticActions](#)¹⁴²³, *strElementName* as String) as Boolean

Description

CanPerformAction and its related methods enable access to the entry-helper functions of Authentic. This function allows easy and consistent modification of the document content, without having to know exactly where the modification will take place. The beginning of the range object is used to locate the next valid location where the specified action can be performed. If the location can be found, the method returns *True*, otherwise it returns *False*.

HINT: To find out all valid element names for a given action, use [CanPerformActionWith](#)¹²⁰².

Errors

| | |
|------|---|
| 2001 | The authentic range object or its related view object is no longer valid. |
| 2005 | Invalid address for the return parameter was specified. |
| 2007 | Invalid action was specified. |

Examples

See [PerformAction](#)¹²²⁴.

26.3.2.5.4 CanPerformActionWith

Method: CanPerformActionWith (*eAction* as [SPYAuthenticActions](#)¹⁴²³, *out_arrElementNames* as Variant)

Description

PerformActionWith and its related methods, enable access to the entry-helper functions of Authentic. This function allows easy and consistent modification of the document content without having to know exactly where the modification will take place.

This method returns an array of those element names that the specified action can be performed with.

HINT: To apply the action use [CanPerformActionWith](#)¹²⁰².

Errors

| | |
|------|--|
| 2001 | The authentic range object, or its related view object is no longer valid. |
| 2005 | Invalid address for the return parameter was specified. |
| 2007 | Invalid action was specified. |

Examples

See [PerformAction](#)¹²²⁴.

26.3.2.5.5 Clone

Method: Clone() as [AuthenticRange](#)¹¹⁹⁹

Description

Returns a copy of the range object.

Errors

| | |
|------|--|
| 2001 | The authentic range object, or its related view object is no longer valid. |
| 2005 | Invalid address for the return parameter was specified. |

26.3.2.5.6 CollapsToBegin

Method: CollapsToBegin() as [AuthenticRange](#)¹¹⁹⁹

Description

Sets the end of the range object to its begin. The method returns the modified range object.

Errors

| | |
|------|--|
| 2001 | The authentic range object, or its related view object is no longer valid. |
| 2005 | Invalid address for the return parameter was specified. |

26.3.2.5.7 CollapsToEnd

Method: CollapsToEnd() as [AuthenticRange](#)¹¹⁹⁹

Description

Sets the beginning of the range object to its end. The method returns the modified range object.

Errors

| | |
|------|--|
| 2001 | The authentic range object, or its related view object is no longer valid. |
| 2005 | Invalid address for the return parameter was specified. |

26.3.2.5.8 Copy

Method: Copy() as Boolean

Description

Returns *False* if the range contains no portions of the document that may be copied.

Returns *True* if text, and in case of fully selected XML elements the elements as well, has been copied to the copy/paste buffer.

Errors

| | |
|------|---|
| 2001 | The authentic range object or its related view object is no longer valid. |
| 2005 | Invalid address for the return parameter was specified. |

26.3.2.5.9 Cut

Method: Cut() as Boolean

Description

Returns *False* if the range contains portions of the document that may not be deleted.

Returns *True* after text, and in case of fully selected XML elements the elements as well, has been deleted from the document and saved in the copy/paste buffer.

Errors

| | |
|------|--|
| 2001 | The authentic range object, or its related view object is no longer valid. |
| 2005 | Invalid address for the return parameter was specified. |

26.3.2.5.10 Delete

Method: Delete() as Boolean

Description

Returns *False* if the range contains portions of the document that may not be deleted.

Returns *True* after text, and in case of fully selected XML elements the elements as well, has been deleted from the document.

Errors

| | |
|------|---|
| 2001 | The authentic range object or its related view object is no longer valid. |
| 2005 | Invalid address for the return parameter was specified. |

26.3.2.5.11 DeleteRow

Method: DeleteRow() as Boolean

Description

If the beginning of the range is inside a dynamic table, this method deletes the selected row. The selection of the range gets modified to point to the next element after the deleted row. The function returns *true*, if the delete operation was successful, otherwise *false*.

Errors

| | |
|------|--|
| 2001 | The authentic range object, or its related view object is no longer valid. |
| 2005 | Invalid address for the return parameter was specified. |

Examples

```
' -----
' Scripting environment - VBScript
' Delete selected row from dynamically growing table
' -----
Dim objRange
' we assume that the active document is open in authentic view mode
Set objRange = Application.ActiveDocument.AuthenticView.Selection

' check if we are in a table
If objRange.IsInDynamicTable Then
    objRange.DeleteRow
End If
```

26.3.2.5.12 DuplicateRow

Method: DuplicateRow() as Boolean

Description

If the beginning of the range is inside a dynamic table, this method inserts a duplicate of the current row after the selected one. The selection of the range gets modified to point to the beginning of the new row. The function returns *true* if the duplicate operation was successful, otherwise *false*.

Errors

| | |
|------|--|
| 2001 | The authentic range object, or its related view object is no longer valid. |
| 2005 | Invalid address for the return parameter was specified. |

Examples

```
' -----
' Scripting environment - VBScript
' duplicate row in current dynamically growable table
' -----
Dim objRange
' we assume that the active document is open in authentic view mode
Set objRange = Application.ActiveDocument.AuthenticView.Selection
```

```
' check if we can insert something
If objRange.IsInDynamicTable Then
    objRange.DuplicateRow
    ' objRange points to beginning of new row
    objRange.Select
End If
```

26.3.2.5.13 EvaluateXPath

Method: EvaluateXPath (strExpression as string) strValue as string

Return Value

The method returns a string

Description

EvaluateXPath() executes an XPath expression with the context node being the beginning of the range selection. The result is returned as a string, in the case of a sequence it is a space-separated string. If XML context node is irrelevant, the user may provide any node, like `AuthenticView.XMLDataRoot`.

Errors

| | |
|------|----------------------|
| 2001 | Invalid object |
| 2005 | Invalid parameter |
| 2008 | Internal error |
| 2202 | Missing context node |
| 2211 | XPath error |

26.3.2.5.14 ExpandTo

Method: ExpandTo (eKind as [SPYAuthenticElementKind](#)¹⁴²⁴), as [AuthenticRange](#)¹¹⁹⁹

Description

Selects the whole element of type eKind, that starts at, or contains, the first cursor position of the range. The method returns the modified range object.

Errors

| | |
|------|--|
| 2001 | The authentic range object, or its related view object is no longer valid. |
| 2003 | Range expansion would be beyond end of document. |
| 2005 | Invalid address for the return parameter was specified. |

26.3.2.5.15 FirstTextPosition

Property: FirstTextPosition as Long

Description

Set or get the left-most text position index of the range object. This index is always less or equal to [LastTextPosition](#)¹²¹⁹. Indexing starts with 0 at document beginning, and increments with every different position that the text cursor can occupy. Incrementing the test position by 1, has the same effect as the cursor-right key. Decrementing the test position by 1 has the same effect as the cursor-left key.

If you set FirstTextPosition to a value greater than the current [LastTextPosition](#)¹²¹⁹, [LastTextPosition](#)¹²¹⁹ gets set to the new FirstTextPosition.

HINT: Use text cursor positions with care, since this is a costly operation compared to XMLData based cursor positioning.

Errors

| | |
|------|--|
| 2001 | The authentic range object, or its related view object is not valid. |
| 2005 | Invalid address for the return parameter was specified. |
| 2006 | A text position outside the document was specified. |

Examples

```
'
'-----
' Scripting environment - VBScript
'-----

Dim objAuthenticView
' we assume that the active document is open in authentic view mode
Set objAuthenticView = Application.ActiveDocument.AuthenticView

nDocStartPosition = objAuthenticView.DocumentBegin.FirstTextPosition
nDocEndPosition = objAuthenticView.DocumentEnd.FirstTextPosition

' let's create a range that selects the whole document
' in an inefficient way
Dim objRange
' we need to get a (any) range object first
Set objRange = objAuthenticView.DocumentBegin
objRange.FirstTextPosition = nDocStartPosition
objRange.LastTextPosition = nDocEndPosition

' let's check if we got it right
If objRange.IsEqual(objAuthenticView.WholeDocument) Then
    MsgBox "Test using direct text cursor positioning was ok"
Else
    MsgBox "Ooops!"
End If
```

26.3.2.5.16 FirstXMLData

Property: FirstXMLData as [XMLData](#)¹³⁷³

Description

Set or get the first XMLData element in the underlying document that is partially, or completely selected by the range. The exact beginning of the selection is defined by the [FirstXMLDataOffset](#)¹²⁰⁸ attribute.

Whenever you set FirstXMLData to a new data object, [FirstXMLDataOffset](#)¹²⁰⁸ gets set to the first cursor position inside this element. Only XMLData objects that have a cursor position may be used. If you set FirstXMLData / [FirstXMLDataOffset](#)¹²⁰⁸ selects a position greater than the current [LastXMLData](#)¹²²⁰ / [LastXMLDataOffset](#)¹²²¹, the latter gets moved to the new start position.

HINT: You can use the [FirstXMLData](#)¹²⁰⁷ and [LastXMLData](#)¹²²⁰ properties to directly access and manipulate the underlying XML document in those cases where the methods available with the [AuthenticRange](#)¹¹⁹⁹ object are not sufficient.

Errors

| | |
|------|--|
| 2001 | The authentic range object, or its related view object is not valid. |
| 2005 | Invalid address for the return parameter was specified. |
| 2008 | Internal error |
| 2009 | The XMLData object cannot be accessed. |

Examples

```
' -----
' Scripting environment - VBScript
' show name of currently selected XMLData element
' -----

Dim objAuthenticView
' we assume that the active document is open in authentic view mode
Set objAuthenticView = Application.ActiveDocument.AuthenticView

Dim objXMLData
Set objXMLData = objAuthenticView.Selection.FirstXMLData
' authentic view adds a 'text' child element to elements
' of the document which have content. So we have to go one
' element up.
Set objXMLData = objXMLData.Parent
MsgBox "Current selection selects element " & objXMLData.Name
```

26.3.2.5.17 FirstXMLDataOffset

Property: FirstXMLDataOffset as Long

Description

Set or get the cursor position offset inside [FirstXMLData](#)¹²⁰⁷ element for the beginning of the range. Offset positions are based on the characters returned by the [Text](#)¹²²⁸ property, and start with 0. When setting a new offset, use -1 to set the offset to the last possible position in the element. The following cases require specific attention:

- The textual form of entries in Combo Boxes, Check Boxes and similar controls can be different from what you see on screen. Although the data offset is based on this text, there only two valid offset positions, one at the beginning and one at the end of the entry. An attempt to set the offset to somewhere in the middle of the entry, will result in the offset being set to the end.

- The textual form of XML Entities might differ in length from their representation on the screen. The offset is based on this textual form.

If [FirstXMLData](#) / [FirstXMLDataOffset](#)¹²⁰⁸ selects a position after the current [LastXMLData](#)¹²²⁰ / [LastXMLDataOffset](#)¹²²¹, the latter gets moved to the new start position.

Errors

| | |
|------|--|
| 2001 | The authentic range object, or its related view object is not valid. |
| 2005 | Invalid offset was specified.
Invalid address for the return parameter was specified. |

Examples

```
' -----
' Scripting environment - VBScript
' Select the complete text of an XMLData element
' using XMLData based selection and ExpandTo
' -----
Dim objAuthenticView
' we assume that the active document is open in authentic view mode
Set objAuthenticView = Application.ActiveDocument.AuthenticView

' first we use the XMLData based range properties
' to select all text of the first XMLData element
' in the current selection
Dim objRange
Set objRange = objAuthenticView.Selection
objRange.FirstXMLDataOffset = 0 ' start at beginning of element text
objRange.LastXMLData = objRange.FirstXMLData ' select only one element
objRange.LastXMLDataOffset = -1 ' select till its end

' the same can be achieved with the ExpandTo method
Dim objRange2
Set objRange2 = objAuthenticView.Selection.ExpandTo(spyAuthenticTag)

' were we successful?
If objRange.IsEqual(objRange2) Then
    objRange.Select()
Else
    MsgBox "Oops"
End If
```

26.3.2.5.18 [GetElementAttributeNames](#)

Method: [GetElementAttributeNames](#) (*strElementName* as String, *out_arrAttributeNames* as Variant)

Description

Retrieve the names of all attributes for the enclosing element with the specified name. Use the element/attribute pairs, to set or get the attribute value with the methods [GetElementAttributeValue](#)¹²¹⁰ and [SetElementAttributeValue](#)¹²²⁷.

Errors

| | |
|------|--|
| 2001 | The authentic range object, or its related view object is no longer valid. |
| 2005 | Invalid element name was specified.
Invalid address for the return parameter was specified. |

Examples

See [SetElementAttributeValue](#)¹²²⁷.

26.3.2.5.19 GetElementAttributeValue

Method: GetElementAttributeValue (*strElementName* as String, *strAttributeName* as String) as String

Description

Retrieve the value of the attribute specified in *strAttributeName*, for the element identified with *strElementName*. If the attribute is supported but has no value assigned, the empty string is returned. To find out the names of attributes supported by an element, use [GetElementAttributeNames](#)¹²⁰⁹, or [HasElementAttribute](#)¹²¹⁵.

Errors

| | |
|------|---|
| 2001 | The authentic range object, or its related view object is no longer valid. |
| 2005 | Invalid element name was specified.
Invalid attribute name was specified.
Invalid address for the return parameter was specified. |

Examples

See [SetElementAttributeValue](#)¹²²⁷.

26.3.2.5.20 GetElementHierarchy

Method: GetElementHierarchy (*out_arrElementNames* as Variant)

Description

Retrieve the names of all XML elements that are parents of the current selection. Inner elements get listed before enclosing elements. An empty list is returned whenever the current selection is not inside a single XMLData element.

The names of the element hierarchy, together with the range object uniquely identify XMLData elements in the document. The attributes of these elements can be directly accessed by [GetElementAttributeNames](#)¹²⁰⁹, and related methods.

Errors

| | |
|------|--|
| 2001 | The authentic range object, or its related view object is no longer valid. |
| 2005 | Invalid address for the return parameter was specified. |

C# Examples

```

'-----
' C#
'-----

namespace ConsoleApplication1
{
    class Program
    {
        static void Main(string[] args)
        {
            XMLSpyLib.Application app = new XMLSpyLib.Application();

            app.ShowApplication(true);

            XMLSpyLib.AuthenticView view = app.ActiveDocument.AuthenticView;
            XMLSpyLib.AuthenticRange range = view.DocumentBegin;

            object o = null;
            range.GetElementHierarchy(ref o);

            object[] elements = (object[])o;

            foreach (string e in elements)
            {
                Console.WriteLine(e);
            }
        }
    }
}

```

Also see: [SetElementAttributeValue](#)¹²²⁷.

26.3.2.5.21 GetEntityNames

Method: GetEntityNames (*out_arrEntityNames* as Variant)

Description

Retrieve the names of all defined entities. The list of retrieved entities is independent of the current selection, or location. Use one of these names with the [InsertEntity](#)¹²¹⁵ function.

Errors

| | |
|------|--|
| 2001 | The authentic range object, or its related view object is no longer valid. |
| 2005 | Invalid address for the return parameter was specified. |

Examples

See: [GetElementHierarchy](#)¹²¹⁰ and [InsertEntity](#)¹²¹⁵.

26.3.2.5.22 GetVariableValue

Method: `GetVariableValue(strName as string) strVal as string`

Return Value

Gets the value of the variable named as the method's parameter.

Errors

| | |
|------|------------------------------|
| 2001 | Invalid object. |
| 2202 | No context. |
| 2204 | No such variable in scope |
| 2205 | Variable cannot be evaluated |
| 2206 | Variable returns sequence |
| 2209 | Invalid parameter |

26.3.2.5.23 Goto

Method: `Goto(eKind as SPYAuthenticElementKind1424, nCount as Long, eFrom as SPYAuthenticDocumentPosition1423) as AuthenticRange1199`

Description

Sets the range to point to the beginning of the nCount element of type eKind. The start position is defined by the parameter eFrom.

Use positive values for nCount to navigate to the document end. Use negative values to navigate to the beginning of the document. The method returns the modified range object.

Errors

| | |
|------|---|
| 2001 | The authentic range object, or its related view object is no longer valid. |
| 2003 | Target lies after end of document. |
| 2004 | Target lies before begin of document. |
| 2005 | Invalid element kind specified.
Invalid start position specified.
Invalid address for the return parameter was specified. |

26.3.2.5.24 GotoNext

Method: `GotoNext(eKind as SPYAuthenticElementKind1424) as AuthenticRange1199`

Description

Sets the range to the beginning of the next element of type eKind. The method returns the modified range object.

Errors

| | |
|------|--|
| 2001 | The authentic range object, or its related view object is no longer valid. |
| 2003 | Target lies after end of document. |
| 2005 | Invalid element kind specified.
Invalid address for the return parameter was specified. |

Examples

```
'-----
' Scripting environment - VBScript
' Scan through the whole document word-by-word
'-----

Dim objAuthenticView
' we assume that the active document is open in authentic view mode
Set objAuthenticView = Application.ActiveDocument.AuthenticView

Dim objRange
Set objRange = objAuthenticView.DocumentBegin
Dim bEndOfDocument
bEndOfDocument = False

On Error Resume Next
While Not bEndOfDocument
    objRange.GotoNext(spyAuthenticWord).Select
    If ((Err.number - vbObjecterror) = 2003) Then
        bEndOfDocument = True
        Err.Clear
    ElseIf (Err.number <> 0) Then
        Err.Raise ' forward error
    End If
Wend
```

26.3.2.5.25 GotoNextCursorPosition

Method: GotoNextCursorPosition() as [AuthenticRange](#) ¹¹⁹⁹

Description

Sets the range to the next cursor position after its current end position. Returns the modified object.

Errors

| | |
|------|--|
| 2001 | The authentic range object, or its related view object is no longer valid. |
| 2003 | Target lies after end of document. |
| 2005 | Invalid address for the return parameter was specified. |

26.3.2.5.26 GotoPrevious

Method: GotoPrevious (eKind as [SPYAuthenticElementKind](#)¹⁴²⁴) as [AuthenticRange](#)¹¹⁹⁹

Description

Sets the range to the beginning of the element of type eKind which is before the beginning of the current range. The method returns the modified range object.

Errors

| | |
|------|--|
| 2001 | The authentic range object, or its related view object is no longer valid. |
| 2004 | Target lies before beginning of document. |
| 2005 | Invalid element kind specified.
Invalid address for the return parameter was specified. |

Examples

```
' -----
' Scripting environment - VBScript
' Scan through the whole document tag-by-tag
' -----
Dim objAuthenticView
' we assume that the active document is open in authentic view mode
Set objAuthenticView = Application.ActiveDocument.AuthenticView

Dim objRange
Set objRange = objAuthenticView.DocumentEnd
Dim bBeginOfDocument
bBeginOfDocument = False

On Error Resume Next
While Not bBeginOfDocument
    objRange.GotoPrevious(spyAuthenticTag).Select
    If ((Err.number - vbObjecterror) = 2004) Then
        bBeginOfDocument = True
        Err.Clear
    ElseIf (Err.number <> 0) Then
        Err.Raise ' forward error
    End If
Wend
```

26.3.2.5.27 GotoPreviousCursorPosition

Method: GotoPreviousCursorPosition() as [AuthenticRange](#)¹¹⁹⁹

Description

Set the range to the cursor position immediately before the current position. Returns the modified object.

Errors

| | |
|------|--|
| 2001 | The authentic range object, or its related view object is no longer valid. |
| 2004 | Target lies before begin of document. |
| 2005 | Invalid address for the return parameter was specified. |

26.3.2.5.28 HasElementAttribute

Method: HasElementAttribute (*strElementName* as String, *strAttributeName* as String) as Boolean

Description

Tests if the enclosing element with name *strElementName*, supports the attribute specified in *strAttributeName*.

Errors

| | |
|------|--|
| 2001 | The authentic range object, or its related view object is no longer valid. |
| 2005 | Invalid element name was specified.
Invalid address for the return parameter was specified. |

26.3.2.5.29 InsertEntity

Method: InsertEntity (*strEntityName* as String)

Description

Replace the ranges selection with the specified entity. The specified entity must be one of the entity names returned by [GetEntityNames](#) ¹²¹¹.

Errors

| | |
|------|--|
| 2001 | The authentic range object, or its related view object is no longer valid. |
| 2005 | Unknown entry name was specified. |

Examples

```
' -----
' Scripting environment - VBScript
' Insert the first entity in the list of available entities
' -----
Dim objRange
' we assume that the active document is open in authentic view mode
Set objRange = Application.ActiveDocument.AuthenticView.Selection

' first we get the names of all available entities as they
' are shown in the entry helper of XMLSpy
Dim arrEntities
objRange.GetEntityNames arrEntities

' we insert the first one of the list
If UBound(arrEntities) >= 0 Then
    objRange.InsertEntity arrEntities(0)
Else
```

```

    MsgBox "Sorry, no entities are available for this document"
End If

```

26.3.2.5.30 InsertRow

Method: InsertRow() as Boolean

Description

If the beginning of the range is inside a dynamic table, this method inserts a new row before the current one. The selection of the range gets modified to point to the beginning of the newly inserted row. The function returns *true* if the insert operation was successful, otherwise *false*.

Errors

| | |
|------|--|
| 2001 | The authentic range object, or its related view object is no longer valid. |
| 2005 | Invalid address for the return parameter was specified. |

Examples

```

' -----
' Scripting environment - VBScript
' Insert row at beginning of current dynamically growing table
' -----

Dim objRange
' we assume that the active document is open in authentic view mode
Set objRange = Application.ActiveDocument.AuthenticView.Selection

' check if we can insert something
If objRange.IsInDynamicTable Then
    objRange.InsertRow
    ' objRange points to beginning of new row
    objRange.Select
End If

```

26.3.2.5.31 IsCopyEnabled

Property: IsCopyEnabled as Boolean (read-only)

Description

Checks if the copy operation is supported for this range.

Errors

| | |
|------|--|
| 2001 | The authentic range object, or its related view object is no longer valid. |
| 2005 | Invalid address for the return parameter was specified. |

26.3.2.5.32 IsCutEnabled

Property: IsCutEnabled as Boolean (read-only)

Description

Checks if the cut operation is supported for this range.

Errors

| | |
|------|--|
| 2001 | The authentic range object, or its related view object is no longer valid. |
| 2005 | Invalid address for the return parameter was specified. |

26.3.2.5.33 IsDeleteEnabled

Property: IsDeleteEnabled as Boolean (read-only)

Description

Checks if the delete operation is supported for this range.

Errors

| | |
|------|--|
| 2001 | The authentic range object, or its related view object is no longer valid. |
| 2005 | Invalid address for the return parameter was specified. |

26.3.2.5.34 IsEmpty

Method: IsEmpty() as Boolean

Description

Tests if the first and last position of the range are equal.

Errors

| | |
|------|--|
| 2001 | The authentic range object, or its related view object is no longer valid. |
| 2005 | Invalid address for the return parameter was specified. |

26.3.2.5.35 IsEqual

Method: IsEqual (objCmpRange as [AuthenticRange](#)¹¹⁹⁹) as Boolean

Description

Tests if the start and end of both ranges are the same.

Errors

| | |
|------|--|
| 2001 | One of the two range objects being compared, is invalid. |
| 2005 | Invalid address for a return parameter was specified. |

26.3.2.5.36 IsFirstRow

Property: IsFirstRow as Boolean (read-only)

Description

Test if the range is in the first row of a table. Which table is taken into consideration depends on the extent of the range. If the selection exceeds a single row of a table, the check is if this table is the first element in an embedding table. See the entry helpers of the user manual for more information.

Errors

| | |
|------|--|
| 2001 | The authentic range object, or its related view object is no longer valid. |
| 2005 | Invalid address for the return parameter was specified. |

26.3.2.5.37 IsInDynamicTable

Method: IsInDynamicTable() as Boolean

Description

Test if the whole range is inside a table that supports the different row operations like 'insert', 'append', duplicate, etc.

Errors

| | |
|------|--|
| 2001 | The authentic range object, or its related view object is no longer valid. |
| 2005 | Invalid address for the return parameter was specified. |

26.3.2.5.38 IsLastRow

Property: IsLastRow as Boolean (read-only)

Description

Test if the range is in the last row of a table. Which table is taken into consideration depends on the extent of the range. If the selection exceeds a single row of a table, the check is if this table is the last element in an embedding table. See the entry helpers of the user manual for more information.

Errors

| | |
|------|--|
| 2001 | The authentic range object, or its related view object is no longer valid. |
| 2005 | Invalid address for the return parameter was specified. |

26.3.2.5.39 IsPasteEnabled

Property: IsPasteEnabled as Boolean (read-only)

Description

Checks if the paste operation is supported for this range.

Errors

| | |
|------|--|
| 2001 | The authentic range object, or its related view object is no longer valid. |
| 2005 | Invalid address for the return parameter was specified. |

26.3.2.5.40 **IsSelected**

Property: IsSelected as Boolean

Description

Returns true() if selection is present. The selection range still can be empty: that happens when e.g. only the cursor is set.

26.3.2.5.41 **IsTextStateApplied**

Method: IsTextStateApplied (*i_strElementName* as String) as Boolean

Description

Checks if all the selected text is embedded into an XML Element with name *i_strElementName*. Common examples for the parameter *i_strElementName* are "strong", "bold" or "italic".

Errors

| | |
|------|--|
| 2001 | The authentic range object, or its related view object is no longer valid. |
| 2005 | Invalid address for the return parameter was specified. |

26.3.2.5.42 **LastTextPosition**

Property: LastTextPosition as Long

Description

Set or get the rightmost text position index of the range object. This index is always greater or equal to [FirstTextPosition](#)¹²⁰⁶. Indexing starts with 0 at the document beginning, and increments with every different position that the text cursor can occupy. Incrementing the test position by 1, has the same effect as the cursor-right key. Decreasing the test position by 1 has the same effect as the cursor-left key.

If you set LastTextPosition to a value less then the current [FirstTextPosition](#)¹²⁰⁶, [FirstTextPosition](#)¹²⁰⁶ gets set to the new LastTextPosition.

HINT: Use text cursor positions with care, since this is a costly operation compared to XMLData based cursor positioning.

Errors

| | |
|------|--|
| 2001 | The authentic range object, or its related view object is not valid. |
| 2005 | Invalid address for the return parameter was specified. |
| 2006 | A text position outside the document was specified. |

Examples

```
'
-----
' Scripting environment - VBScript
'
-----
Dim objAuthenticView
' we assume that the active document is open in authentic view mode
Set objAuthenticView = Application.ActiveDocument.AuthenticView

nDocStartPosition = objAuthenticView.DocumentBegin.FirstTextPosition
nDocEndPosition = objAuthenticView.DocumentEnd.FirstTextPosition

' let's create a range that selects the whole document
' in an inefficient way
Dim objRange
' we need to get a (any) range object first
Set objRange = objAuthenticView.DocumentBegin
objRange.FirstTextPosition = nDocStartPosition
objRange.LastTextPosition = nDocEndPosition

' let's check if we got it right
If objRange.IsEqual(objAuthenticView.WholeDocument) Then
    MsgBox "Test using direct text cursor positioning was ok"
Else
    MsgBox "Oops!"
End If
```

26.3.2.5.43 LastXMLData

Property: LastXMLData as [XMLData](#)¹³⁷³

Description

Set or get the last XMLData element in the underlying document that is partially or completely selected by the range. The exact end of the selection is defined by the [LastXMLDataOffset](#)¹²²¹ attribute.

Whenever you set LastXMLData to a new data object, [LastXMLDataOffset](#)¹²²¹ gets set to the last cursor position inside this element. Only XMLData objects that have a cursor position may be used. If you set LastXMLData / [LastXMLDataOffset](#)¹²²¹, select a position less than the current [FirstXMLData](#)¹²⁰⁷ / [FirstXMLDataOffset](#)¹²⁰⁸, the latter gets moved to the new end position.

HINT: You can use the [FirstXMLData](#)¹²⁰⁷ and [LastXMLData](#)¹²²⁰ properties to directly access and manipulate the underlying XML document in those cases, where the methods available with the [AuthenticRange](#)¹¹⁹⁹ object are not sufficient.

Errors

| | |
|------|--|
| 2001 | The authentic range object, or its related view object is not valid. |
|------|--|

| | |
|------|---|
| 2005 | Invalid address for the return parameter was specified. |
| 2008 | Internal error |
| 2009 | The XMLData object cannot be accessed. |

26.3.2.5.44 LastXMLDataOffset

Property: LastXMLDataOffset as Long

Description

Set or get the cursor position inside [LastXMLData](#)¹²²⁰ element for the end of the range.

Offset positions are based on the characters returned by the [Text](#)¹²²⁸ property and start with 0. When setting a new offset, use -1 to set the offset to the last possible position in the element. The following cases require specific attention:

- The textual form of entries in Combo Boxes, Check Boxes and similar controls can be different from what you see on the screen. Although, the data offset is based on this text, there only two valid offset positions, one at the beginning and one at the end of the entry. An attempt to set the offset to somewhere in the middle of the entry, will result in the offset being set to the end.
- The textual form of XML Entities might differ in length from their representation on the screen. The offset is based on this textual form.

If [LastXMLData](#)¹²²⁰ / [LastXMLDataOffset](#)¹²²¹ selects a position before [FirstXMLData](#)¹²⁰⁷ / [FirstXMLDataOffset](#)¹²⁰⁸, the latter gets moved to the new end position.

Errors

| | |
|------|--|
| 2001 | The authentic range object, or its related view object is not valid. |
| 2005 | Invalid offset was specified.
Invalid address for the return parameter was specified. |

Examples

```
' -----
' Scripting environment - VBScript
' Select the complete text of an XMLData element
' using XMLData based selection and ExpandTo
' -----
Dim objAuthenticView
' we assume that the active document is open in authentic view mode
Set objAuthenticView = Application.ActiveDocument.AuthenticView

' first we use the XMLData based range properties
' to select all text of the first XMLData element
' in the current selection
Dim objRange
Set objRange = objAuthenticView.Selection
objRange.FirstXMLDataOffset = 0 ' start at beginning of element text
objRange.LastXMLData = objRange.FirstXMLData ' select only one element
objRange.LastXMLDataOffset = -1 ' select till its end
```

```
' the same can be achieved with the ExpandTo method
Dim objRange2
Set objRange2 = objAuthenticView.Selection.ExpandTo(spyAuthenticTag)

' were we successful?
If objRange.IsEqual(objRange2) Then
    objRange.Select()
Else
    MsgBox "Ooops"
End If
```

26.3.2.5.45 MoveBegin

Method: MoveBegin (eKind as [SPYAuthenticElementKind](#)¹⁴²⁴, nCount as Long) as [AuthenticRange](#)¹¹⁹⁹

Description

Move the beginning of the range to the beginning of the nCount element of type eKind. Counting starts at the current beginning of the range object.

Use positive numbers for nCount to move towards the document end, use negative numbers to move towards document beginning. The end of the range stays unmoved, unless the new beginning would be larger than it. In this case, the end is moved to the new beginning. The method returns the modified range object.

Errors

| | |
|------|--|
| 2001 | The authentic range object, or its related view object is no longer valid. |
| 2003 | Target lies after end of document. |
| 2004 | Target lies before beginning of document. |
| 2005 | Invalid element kind specified.
Invalid address for the return parameter was specified. |

26.3.2.5.46 MoveEnd

Method: MoveEnd (eKind as [SPYAuthenticElementKind](#)¹⁴²⁴, nCount as Long) as [AuthenticRange](#)¹¹⁹⁹

Description

Move the end of the range to the begin of the nCount element of type eKind. Counting starts at the current end of the range object.

Use positive numbers for nCount to move towards the document end, use negative numbers to move towards document beginning. The beginning of the range stays unmoved, unless the new end would be less than it. In this case, the beginning gets moved to the new end. The method returns the modified range object.

Errors

| | |
|------|--|
| 2001 | The authentic range object, or its related view object is no longer valid. |
| 2003 | Target lies after end of document. |
| 2004 | Target lies before begin of document. |

| | |
|------|--|
| 2005 | Invalid element kind specified.
Invalid address for the return parameter was specified. |
|------|--|

26.3.2.5.47 MoveRowDown

Method: MoveRowDown() as Boolean

Description

If the beginning of the range is inside a dynamic table and selects a row which is not the last row in this table, this method swaps this row with the row immediately below. The selection of the range moves with the row, but does not otherwise change. The function returns *true* if the move operation was successful, otherwise *false*.

Errors

| | |
|------|---|
| 2001 | The authentic range object or its related view object is no longer valid. |
| 2005 | Invalid address for the return parameter was specified. |

26.3.2.5.48 MoveRowUp

Method: MoveRowUp() as Boolean

Description

If the beginning of the range is inside a dynamic table and selects a row which is not the first row in this table, this method swaps this row with the row above. The selection of the range moves with the row, but does not change otherwise. The function returns *true* if the move operation was successful, otherwise *false*.

Errors

| | |
|------|--|
| 2001 | The authentic range object, or its related view object is no longer valid. |
| 2005 | Invalid address for the return parameter was specified. |

26.3.2.5.49 Parent

Property: Parent as [AuthenticView](#)¹²²³ (read-only)

Description

Access the view that owns this range object.

Errors

| | |
|------|--|
| 2001 | The authentic range object, or its related view object is no longer valid. |
| 2005 | Invalid address for the return parameter was specified. |

26.3.2.5.50 Paste

Method: Paste() as Boolean

Description

Returns *False* if the copy/paste buffer is empty, or its content cannot replace the current selection.

Otherwise, deletes the current selection, inserts the content of the copy/paste buffer, and returns *True*.

Errors

| | |
|------|--|
| 2001 | The authentic range object, or its related view object is no longer valid. |
| 2005 | Invalid address for the return parameter was specified. |

26.3.2.5.51 PerformAction

Method: PerformAction (*eAction* as [SPYAuthenticActions](#)¹⁴²³, *strElementName* as String) as Boolean

Description

PerformAction and its related methods, give access to the entry-helper functions of Authentic. This function allows easy and consistent modification of the document content without a need to know exactly where the modification will take place. The beginning of the range object is used to locate the next valid location where the specified action can be performed. If no such location can be found, the method returns *False*. Otherwise, the document gets modified and the range points to the beginning of the modification.

HINT: To find out element names that can be passed as the second parameter use [CanPerformActionWith](#)¹²⁰².

Errors

| | |
|------|--|
| 2001 | The authentic range object, or its related view object is no longer valid. |
| 2005 | Invalid address for the return parameter was specified. |
| 2007 | Invalid action was specified. |

Examples

```
'
'-----
' Scripting environment - VBScript
' Insert the innermost element
'-----
Dim objRange
' we assume that the active document is open in authentic view mode
Set objRange = Application.ActiveDocument.AuthenticView.Selection

' we determine the elements that can be inserted at the current position
Dim arrElements()
objRange.CanPerformActionWith spyAuthenticInsertBefore, arrElements

' we insert the first (innermost) element
If UBound(arrElements) >= 0 Then
    objRange.PerformAction spyAuthenticInsertBefore, arrElements(0)
    ' objRange now points to the beginning of the inserted element
    ' we set a default value and position at its end
    objRange.Text = "Hello"
    objRange.ExpandTo(spyAuthenticTag).CollapsesToEnd().Select
Else
    MsgBox "Can't insert any elements at current position"
```

End If

26.3.2.5.52 Select

Method: Select()

Description

Makes this range the current user interface selection. You can achieve the same result using:
'objRange.Parent.Selection = objRange'

Errors

| | |
|------|---|
| 2001 | The authentic range object or its related view object is no longer valid. |
|------|---|

Examples

```
' _____
' Scripting environment - VBScript
' _____

Dim objAuthenticView
' we assume that the active document is open in authentic view mode
Set objAuthenticView = Application.ActiveDocument.AuthenticView

' set current selection to end of document
objAuthenticView.DocumentEnd.Select()
```

26.3.2.5.53 SelectNext

Method: SelectNext (eKind as [SPYAuthenticElementKind](#)¹⁴²⁴) as [AuthenticRange](#)¹¹⁹⁹

Description

Selects the element of type eKind after the current end of the range. The method returns the modified range object.

Errors

| | |
|------|--|
| 2001 | The authentic range object, or its related view object is no longer valid. |
| 2003 | Target lies after end of document. |
| 2005 | Invalid element kind specified.
Invalid address for the return parameter was specified. |

Examples

```
' _____
' Scripting environment - VBScript
' Scan through the whole document word-by-word
' _____

Dim objAuthenticView
' we assume that the active document is open in authentic view mode
Set objAuthenticView = Application.ActiveDocument.AuthenticView

Dim objRange
```

```

Set objRange = objAuthenticView.DocumentBegin
Dim bEndOfDocument
bEndOfDocument = False

On Error Resume Next
While Not bEndOfDocument
    objRange.SelectNext(spyAuthenticWord).Select
    If ((Err.number - vbObjecterror) = 2003) Then
        bEndOfDocument = True
        Err.Clear
    ElseIf (Err.number <> 0) Then
        Err.Raise ' forward error
    End If
Wend

```

26.3.2.5.54 SelectPrevious

Method: GotoPrevious (eKind as [SPYAuthenticElementKind](#)¹⁴²⁴) as [AuthenticRange](#)¹¹⁹⁹

Description

Selects the element of type eKind before the current beginning of the range. The method returns the modified range object.

Errors

| | |
|------|--|
| 2001 | The authentic range object, or its related view object is no longer valid. |
| 2004 | Target lies before begin of document. |
| 2005 | Invalid element kind specified.
Invalid address for the return parameter was specified. |

Examples

```

' -----
' Scripting environment - VBScript
' Scan through the whole document tag-by-tag
' -----

Dim objAuthenticView
' we assume that the active document is open in authentic view mode
Set objAuthenticView = Application.ActiveDocument.AuthenticView

Dim objRange
Set objRange = objAuthenticView.DocumentEnd
Dim bBeginOfDocument
bBeginOfDocument = False

On Error Resume Next
While Not bBeginOfDocument
    objRange.SelectPrevious(spyAuthenticTag).Select
    If ((Err.number - vbObjecterror) = 2004) Then
        bBeginOfDocument = True
    End If
Wend

```

```

        Err.Clear
    Elseif (Err.number <> 0) Then
        Err.Raise ' forward error
    End If
Wend

```

26.3.2.5.55 SetElementAttributeValue

Method: SetElementAttributeValue (*strElementName* as String, *strAttributeName* as String, *strAttributeValue* as String)

Description

Set the value of the attribute specified in *strAttributeName* for the element identified with *strElementName*. If the attribute is supported but has no value assigned, the empty string is returned. To find out the names of attributes supported by an element, use [GetElementAttributeNames](#)¹²⁰⁹, or [HasElementAttribute](#)¹²¹⁵.

Errors

| | |
|------|--|
| 2001 | The authentic range object or its related view object is no longer valid. |
| 2005 | Invalid element name was specified.
Invalid attribute name was specified.
Invalid attribute value was specified. |

Examples

```

' -----
' Scripting environment - VBScript
' Get and set element attributes
' -----

Dim objRange
' we assume that the active document is open in authentic view mode
Set objRange = Application.ActiveDocument.AuthenticView.Selection

' first we find out all the elements below the beginning of the range
Dim arrElements
objRange.GetElementHierarchy arrElements

If IsArray(arrElements) Then
    If UBound(arrElements) >= 0 Then
        ' we use the top level element and find out its valid attributes
        Dim arrAttrs()
        objRange.GetElementAttributeNames arrElements(0), arrAttrs

        If UBound(arrAttrs) >= 0 Then
            ' we retrieve the current value of the first valid attribute
            Dim strAttrVal
            strAttrVal = objRange.GetElementAttributeValue (arrElements(0), arrAttrs(0))
            msgbox "current value of " & arrElements(0) & "/" & arrAttrs(0) & " is: " & strAttrVal

            ' we change this value and read it again
            strAttrVal = "Hello"
        End If
    End If
End If

```

```

        objRange.SetElementAttributeValue arrElements(0), arrAttrs(0), strAttrVal
        strAttrVal = objRange.GetElementAttributeValue (arrElements(0), arrAttrs(0))
        msgbox "new value of " & arrElements(0) & "/" & arrAttrs(0) & " is: " & strAttrVal
    End If
End If
End If

```

26.3.2.5.56 SetFromRange

Method: SetFromRange (*objSrcRange* as [AuthenticRange](#)¹¹⁹⁹)

Description

Sets the range object to the same beginning and end positions as *objSrcRange*.

Errors

| | |
|------|---|
| 2001 | One of the two range objects, is invalid. |
| 2005 | Null object was specified as source object. |

26.3.2.5.57 SetVariableValue

Method: SetVariableValue (*strName* as string, *strValue* as string)

Return Value

Sets the value (second parameter) of the variable named in the first parameter.

Errors

| | |
|------|------------------------------|
| 2201 | Invalid object. |
| 2202 | No context. |
| 2204 | No such variable in scope |
| 2205 | Variable cannot be evaluated |
| 2206 | Variable returns sequence |
| 2207 | Variable read-only |
| 2208 | No modification allowed |

26.3.2.5.58 Text

Property: Text as String

Description

Set or get the textual content selected by the range object.

The number of characters retrieved are not necessarily identical, as there are text cursor positions between the beginning and end of the selected range. Most document elements support an end cursor position different to the beginning cursor position of the following element. Drop-down lists maintain only one cursor position, but can select strings of any length. In the case of radio buttons and check boxes, the text property value holds the string of the corresponding XML element.

If the range selects more than one element, the text is the concatenation of the single texts. XML entities are expanded so that '&' is expected as '&'.

Setting the text to the empty string, does not delete any XML elements. Use [Cut](#)¹²⁰⁴, [Delete](#)¹²⁰⁴ or [PerformAction](#)¹²²⁴ instead.

Errors

| | |
|------|---|
| 2001 | The authentic range object or its related view object is no longer valid. |
| 2005 | Invalid address for a return parameter was specified. |

26.3.2.6 AuthenticView

| Properties | Methods | Events |
|--|---|--|
| Application ¹²³⁹ | Goto ¹²⁴³ | OnBeforeCopy ¹²³⁰ |
| AsXMLString ¹²³⁹ | IsRedoEnabled ¹²⁴⁴ | OnBeforeCut ¹²³¹ |
| DocumentBegin ¹²⁴¹ | IsUndoEnabled ¹²⁴⁴ | OnBeforeDelete ¹²³¹ |
| DocumentEnd ¹²⁴¹ | Print ¹²⁴⁵ | OnBeforeDrop ¹²³² |
| Event ¹²⁴² | Redo ¹²⁴⁶ | OnBeforePaste ¹²³³ |
| MarkupVisibility ¹²⁴⁵ | Undo ¹²⁴⁷ | OnDragOver ¹²³³ |
| Parent ¹²⁴⁵ | UpdateXMLInstanceEntities ¹²⁴⁷ | OnKeyBoardEvent ¹²³⁵ |
| Selection ¹²⁴⁶ | | OnMouseEvent ¹²³⁶ |
| XMLDataRoot ¹²⁴⁸ | | OnSelectionChanged ¹²³⁶ |
| WholeDocument ¹²⁴⁸ | | |

Description

AuthenticView and its child objects [AuthenticRange](#)¹¹⁹⁹ and AuthenticDataTransfer provide you with an interface for **Authentic View**, which allow easy and consistent modification of document contents. These interfaces replace the following interfaces which are marked now as **obsolete**:

OldAuthenticView (old name was DocEditView)

AuthenticSelection (old name was DocEditSelection, superseded by [AuthenticRange](#)¹¹⁹⁹)

AuthenticEvent (old name was DocEditEvent)

AuthenticView gives you easy access to specific features such as printing, the multi-level undo buffer, and the current cursor selection, or position.

AuthenticView uses objects of type [AuthenticRange](#)¹¹⁹⁹ to make navigation inside the document straightforward, and to allow for the flexible selection of logical text elements. Use the properties [DocumentBegin](#)¹²⁴¹, [DocumentEnd](#)¹²⁴¹, or [WholeDocument](#)¹²⁴⁸ for simple selections, while using the [Goto](#)¹²⁴³ method for more complex selections. To navigate relative to a given document range, see the methods and properties of the [AuthenticRange](#)¹¹⁹⁹ object.

Examples

```
' -----
' XMLSpy scripting environment - VBScript
' secure access to authentic view object
' -----
Dim objDocument
Set objDocument = Application.ActiveDocument
If (Not objDocument Is Nothing) Then
    ' we have an active document, now check for view mode
    If (objDocument.CurrentViewMode <> spyViewAuthentic) Then
        If (Not objDocument.SwitchViewMode (spyViewAuthentic)) Then
            MsgBox "Active document does not support authentic view mode"
        Else
            ' now it is safe to access the authentic view object
            Dim objAuthenticView
            Set objAuthenticView = objDocument.AuthenticView
            ' now use the authentic view object

        End If
    End If
Else
    MsgBox "No document is open"
End If
```

26.3.2.6.1 Events

26.3.2.6.1.1 OnBeforeCopy

Event: OnBeforeCopy() as Boolean

Scripting environment - VBScript:

```
Function On_AuthenticBeforeCopy()
    ' On_AuthenticBeforeCopy = False ' to disable operation
End Function
```

Scripting environment - JScript:

```
function On_AuthenticBeforeCopy()
{
    // return false; /* to disable operation */
}
```

IDE Plugin:

```
IXMLSpyPlugIn.OnEvent (21, ...) // nEventId = 21
```

Description

This event gets triggered before a copy operation gets performed on the document. Return *True* (or nothing) to allow copy operation. Return *False* to disable copying.

26.3.2.6.1.2 *OnBeforeCut*

Event: OnBeforeCut() as Boolean

Scripting environment - VBScript:

```
Function On_AuthenticBeforeCut()  
    ' On_AuthenticBeforeCut = False ' to disable operation  
End Function
```

Scripting environment - JScript:

```
function On_AuthenticBeforeCut()  
{  
    // return false; /* to disable operation */  
}
```

IDE Plugin:

```
IXMLSpyPlugIn.OnEvent (20, ...) // nEventId = 20
```

Description

This event gets triggered before a cut operation gets performed on the document. Return *True* (or nothing) to allow cut operation. Return *False* to disable operation.

26.3.2.6.1.3 *OnBeforeDelete*

Event: OnBeforeDelete() as Boolean

Scripting environment - VBScript:

```
Function On_AuthenticBeforeDelete()  
    ' On_AuthenticBeforeDelete = False ' to disable operation  
End Function
```

Scripting environment - JScript:

```
function On_AuthenticBeforeDelete()  
{  
    // return false; /* to disable operation */  
}
```

IDE Plugin:

```
IXMLSpyPlugIn.OnEvent (22, ...) // nEventId = 22
```

Description

This event gets triggered before a delete operation gets performed on the document. Return *True* (or nothing) to allow delete operation. Return *False* to disable operation.

26.3.2.6.1.4 OnBeforeDrop

Event: OnBeforeDrop (*i_nXPos* as Long, *i_nYPos* as Long, *i_ipRange* as [AuthenticRange](#)¹¹⁹⁹, *i_ipData* as cancelBoolean)

Scripting environment - VBScript:

```
Function On_AuthenticBeforeDrop(nXPos, nYPos, objRange, objData)
    ' On_AuthenticBeforeDrop = False ' to disable operation
End Function
```

Scripting environment - JScript:

```
function On_AuthenticBeforeDrop(nXPos, nYPos, objRange, objData)
{
    // return false; /* to disable operation */
}
```

IDE Plugin:

```
IXMLSpyPlugIn.OnEvent (11, ...) // nEventId = 11
```

Description

This event gets triggered whenever a previously dragged object gets dropped inside the application window. All event related information gets passed as parameters.

The first two parameters specify the mouse position at the time when the event occurred. The parameter *objRange* passes a range object that selects the XML element below the mouse position. The value of this parameter might be *NULL*. Be sure to check before you access the range object. The parameter *objData* allows to access information about the object being dragged.

Return *False* to cancel the drop operation. Return *True* (or nothing) to continue normal operation.

Examples

```
' -----
' VB code snippet - connecting to object level events
' -----
' access XMLSpy (without checking for any errors)
Dim objSpy As XMLSpyLib.Application
Set objSpy = GetObject("", "XMLSpy.Application")

' this is the event callback routine connected to the OnBeforeDrop
' event of object objView
Private Function objView_OnBeforeDrop(ByVal i_nXPos As Long, ByVal i_nYPos As Long,
    ByVal i_ipRange As IAuthenticRange,
    ByVal i_ipData As IAuthenticDataTransfer) As Boolean

    If (Not i_ipRange Is Nothing) Then
        MsgBox ("Dropping on content is prohibited");
        Return False;
    Else
        Return True;
    End If
End Function
```

```
' use VBA keyword WithEvents to connect to object-level event
Dim WithEvents objView As XMLSpyLib.AuthenticView
Set objView = objSpy.ActiveDocument.AuthenticView

' continue here with something useful ...
' and serve the windows message loop
```

26.3.2.6.1.5 OnBeforePaste

Event: OnBeforePaste (*objData* as Variant, *strType* as String) as Boolean

Scripting environment - VBScript:

```
Function On_AuthenticBeforePaste(objData, strType)
    ' On_AuthenticBeforePaste = False ' to disable operation
End Function
```

Scripting environment - JScript:

```
function On_AuthenticBeforePaste(objData, strType)
{
    // return false; /* to disable operation */
}
```

IDE Plugin:

```
IXMLSpyPlugIn.OnEvent (19, ...) // nEventId = 19
```

Description

This event gets triggered before a paste operation gets performed on the document. The parameter *strType* is one of "TEXT", "UNICODETEXT" or "IUNKNOWN". In the first two cases *objData* contains a string representation of the object that will be pasted. In the later case, *objData* contains a pointer to an IUnknown COM interface.

Return *True* (or nothing) to allow paste operation. Return *False* to disable operation.

26.3.2.6.1.6 OnBeforeSave

Event: OnBeforeSave (SaveAs flag) as Boolean

Description: `OnBeforeSave` gives the opportunity to e.g. warn the user about overwriting the existing XML document, or to make the document read-only when specific circumstances are not met. The event will be fired before the file dialog is shown.

26.3.2.6.1.7 OnDragOver

Event: OnDragOver (*nXPos* as Long, *nYPos* as Long, *eMouseEvent* as [SPYMouseEvent](#)¹⁴²⁸, *objRange* as [AuthenticRange](#)¹¹⁹⁹, *objData* as AuthenticDataTransfer) as Boolean

Scripting environment - VBScript:

```
Function On_AuthenticDragOver(nXPos, nYPos, eMouseEvent, objRange, objData)
    ' On_AuthenticDragOver = False ' to disable operation
End Function
```

Scripting environment - JScript:

```
function On_AuthenticDragOver(nXPos, nYPos, eMouseEvent, objRange, objData)
{
    // return false; /* to disable operation */
}
```

IDE Plugin:

```
IXMLSpyPlugIn.OnEvent (10, ...) // nEventId = 10
```

Description

This event gets triggered whenever an object from within or outside of Authentic View gets dragged with the mouse over the application window. All event related information gets passed as parameters.

The first three parameters specify the mouse position, the mouse button status and the status of the virtual keys at the time when the event occurred. The parameter *objRange* passes a range object that selects the XML element below the mouse position. The value of this parameter might be *NULL*. Be sure to check before you access the range object. The parameter *objData* allows to access information about the object being dragged.

Return *False* to cancel the drag operation. Return *True* (or nothing) to continue normal operation.

Examples

```
' -----
' VB code snippet - connecting to object level events
' -----
' access XMLSpy (without checking for any errors)
Dim objSpy As XMLSpyLib.Application
Set objSpy = GetObject("", "XMLSpy.Application")

' this is the event callback routine connected to the OnDragOver
' event of object objView
Private Function objView_OnDragOver(ByVal i_nXPos As Long, ByVal i_nYPos As Long,
    ByVal i_eMouseEvent As SPYMouseEvent,
    ByVal i_ipRange As IAuthenticRange,
    ByVal i_ipData As IAuthenticDataTransfer) As Boolean

    If (((i_eMouseEvent And spyShiftKeyDownMask) <> 0) And
        (Not i_ipRange Is Nothing)) Then
        MsgBox ("Floating over element " & i_ipRange.FirstXMLData.Parent.Name);
    End If

    Return True;
End Function

' use VBA keyword WithEvents to connect to object-level event
Dim WithEvents objView As XMLSpyLib.AuthenticView
Set objView = objSpy.ActiveDocument.AuthenticView
```

```
' continue here with something useful ...
' and serve the windows message loop
```

26.3.2.6.1.8 OnKeyboardEvent

Event: OnKeyboardEvent (eKeyEvent as [SPYKeyEvent](#)¹⁴²⁷, nKeyCode as Long, nVirtualKeyStatus as Long) as Boolean

Scripting environment - VBScript:

```
Function On_AuthenticKeyboardEvent(eKeyEvent, nKeyCode, nVirtualKeyStatus)
    ' On_AuthenticKeyboardEvent = True ' to cancel bubbling of event
End Function
```

Scripting environment - JScript:

```
function On_AuthenticKeyboardEvent(eKeyEvent, nKeyCode, nVirtualKeyStatus)
{
    // return true; /* to cancel bubbling of event */
}
```

IDE Plugin:

```
IXMLSpyPlugIn.OnEvent (30, ...) // nEventId = 30
```

Description

This event gets triggered for *WM_KEYDOWN*, *WM_KEYUP* and *WM_CHAR* Windows messages.

The actual message type is available in the *eKeyEvent* parameter. The status of virtual keys is combined in the parameter *nVirtualKeyStatus*. Use the bit-masks defined in the enumeration datatype [SPYVirtualKeyMask](#)¹⁴³⁵, to test for the different keys or their combinations.

26.3.2.6.1.9 OnLoad

Event: OnLoad ()

Description: OnLoad can be used e.g. to restrict some AuthenticView functionality, as shown in the example below:

```
function On_AuthenticLoad( )
{
    // We are disabling all entry helpers in order to prevent user from manipulating XML tree
    AuthenticView.DisableElementEntryHelper();
    AuthenticView.DisableAttributeEntryHelper();

    // We are also disabling the markup buttons for the same purpose
    AuthenticView.SetToolBarButtonState( 'AuthenticMarkupSmall', authenticToolBarButtonDisabled );
    AuthenticView.SetToolBarButtonState( 'AuthenticMarkupLarge', authenticToolBarButtonDisabled );
    AuthenticView.SetToolBarButtonState( 'AuthenticMarkupMixed', authenticToolBarButtonDisabled );
}
```

In the example the status of the Markup Small, Markup Large, Markup Mixed toolbar buttons are manipulated with the help of button identifiers. See [complete list](#)¹²³⁷.

26.3.2.6.1.10 OnMouseEvent

Event: OnMouseEvent (*nXPos* as Long, *nYPos* as Long, *eMouseEvent* as [SPYMouseEvent](#)¹⁴²⁸, *objRange* as [AuthenticRange](#)¹¹⁹⁹) as Boolean

Scripting environment - VBScript:

```
Function On_AuthenticMouseEvent(nXPos, nYPos, eMouseEvent, objRange)
    ' On_AuthenticMouseEvent = True ' to cancel bubbling of event
End Function
```

Scripting environment - JScript:

```
function On_AuthenticMouseEvent(nXPos, nYPos, eMouseEvent, objRange)
{
    // return true; /* to cancel bubbling of event */
}
```

IDE Plugin:

```
IXMLSpyPlugIn.OnEvent (31, ...) // nEventId = 31
```

Description

This event gets triggered for every mouse movement and mouse button Windows message.

The actual message type and the mouse buttons status, is available in the *eMouseEvent* parameter. Use the bit-masks defined in the enumeration datatype [SPYMouseEvent](#)¹⁴²⁸ to test for the different messages, button status, and their combinations.

The parameter *objRange* identifies the part of the document found at the current mouse cursor position. The range object always selects a complete tag of the document. (This might change in future versions, when a more precise positioning mechanism becomes available). If no selectable part of the document is found at the current position, the range object is *null*.

26.3.2.6.1.11 OnSelectionChanged

Event: OnSelectionChanged (*objNewSelection* as [AuthenticRange](#)¹¹⁹⁹)

Scripting environment - VBScript:

```
Function On_AuthenticSelectionChanged (objNewSelection)
End Function
```

Scripting environment - JScript:

```
function On_AuthenticSelectionChanged (objNewSelection)
{
}
```

IDE Plugin:

```
IXMLSpyPlugIn.OnEvent (23, ...) // nEventId = 23
```

Description

This event gets triggered whenever the selection in the user interface changes.

Examples

```

'-----
' VB code snippet - connecting to object level events
'-----
' access XMLSpy (without checking for any errors)
Dim objSpy As XMLSpyLib.Application
Set objSpy = GetObject("", "XMLSpy.Application")

' this is the event callback routine connected to the OnSelectionChanged
' event of object objView
Private Sub objView_OnSelectionChanged (ByVal i_ipNewRange As XMLSpyLib.IAuthenticRange)
    MsgBox ("new selection: " & i_ipNewRange.Text)
End Sub

' use VBA keyword WithEvents to connect to object-level event
Dim WithEvents objView As XMLSpyLib.AuthenticView
Set objView = objSpy.ActiveDocument.AuthenticView

' continue here with something useful ...
' and serve the windows message loop

```

26.3.2.6.1.12 OnToolbarButtonClicked**Event:** OnToolbarButtonClicked (Button identifier)**Description:** OnToolbarButtonClicked is fired when a toolbar button was clicked by user. The parameter button identifier helps to determine which button was clicked. The list of predefined button identifiers is below:

- AuthenticPrint
- AuthenticPrintPreview
- AuthenticUndo
- AuthenticRedo
- AuthenticCut
- AuthenticCopy
- AuthenticPaste
- AuthenticClear
- AuthenticMarkupHide
- AuthenticMarkupLarge
- AuthenticMarkupMixed
- AuthenticMarkupSmall
- AuthenticValidate
- AuthenticChangeWorkingDBXMLCell
- AuthenticSave
- AuthenticSaveAs
- AuthenticReload
- AuthenticTableInsertRow
- AuthenticTableAppendRow
- AuthenticTableDeleteRow
- AuthenticTableInsertCol
- AuthenticTableAppendCol
- AuthenticTableDeleteCol

- AuthenticTableJoinCellRight
- AuthenticTableJoinCellLeft
- AuthenticTableJoinCellAbove
- AuthenticTableJoinCellBelow
- AuthenticTableSplitCellHorizontally
- AuthenticTableSplitCellVertically
- AuthenticTableAlignCellContentTop
- AuthenticTableCenterCellVertically
- AuthenticTableAlignCellContentBottom
- AuthenticTableAlignCellContentLeft
- AuthenticTableCenterCellContent
- AuthenticTableAlignCellContentRight
- AuthenticTableJustifyCellContent
- AuthenticTableInsertTable
- AuthenticTableDeleteTable
- AuthenticTableProperties
- AuthenticAppendRow
- AuthenticInsertRow
- AuthenticDuplicateRow
- AuthenticMoveRowUp
- AuthenticMoveRowDown
- AuthenticDeleteRow
- AuthenticDefineEntities
- AuthenticXMLSignature

For custom buttons the user might add his own identifiers. Please, note that the user must take care, as the identifiers are not checked for uniqueness. The same identifiers can be used to identify buttons in the `Set/GetToolBarState()` COM API calls. By adding code for different buttons, the user is in the position to completely redefine the `AuthenticView` toolbar behavior, adding own methods for table manipulation, etc.

26.3.2.6.1.13 *OnToolBarButtonExecuted*

Event: `OnToolBarButtonExecuted` (Button identifier)

Description: `OnToolBarButtonClicked` is fired when a toolbar button was clicked by user. The parameter button identifier helps to determine which button was clicked. See the list of [predefined button identifiers](#)¹²³⁷.

`OnToolBarButtonExecuted` is fired after the toolbar action was executed. It is useful e.g. to add update code, as shown in the example below:

```
//event fired when a toolbar button action was executed
function On_AuthenticToolBarButtonExecuted( varBtnIdentifier )
{
    // After whatever command user has executed - make sure to update toolbar button states
    UpdateOwnToolBarButtonStates();
}
```

In this case `UpdateOwnToolBarButtonStates` is a user function defined in the Global Declarations.

26.3.2.6.1.14 OnUserAddedXMLNode

Event: OnUserAddedXMLNode (XML node)

Description: OnUserAddedXMLNode will be fired when the user adds an XML node as a primary action. This happens in the situations, where the user clicks on

- auto-add hyperlinks (see example OnUserAddedXMLNode.sps)
- the Insert..., Insert After..., Insert Before... context menu items
- Append row, Insert row toolbar buttons
- Insert After..., Insert Before... actions in element entry helper (outside StyleVision)

The event doesn't get fired on Duplicate row, or when the node was added externally (e.g. via COM API), or on Apply (e.g. Text State Icons), or when in XML table operations or in DB operations.

The event parameter is the XML node object, which was added giving the user an opportunity to manipulate the XML node added. An elaborate example for an event handler can be found in the OnUserAddedXMLNode.sps file.

26.3.2.6.2 Application

Property: Application as [Application](#)¹¹⁷² (read-only)

Description

Accesses the XMLSpy application object.

Errors

| | |
|------|---|
| 2000 | The authentic view object is no longer valid. |
| 2005 | Invalid address for the return parameter was specified. |

26.3.2.6.3 AsXMLString

Property: AsXMLString as String

Description

Returns or sets the document content as an XML string. Setting the content to a new value does not change the schema file or sps file in use. If the new XMLString does not match the actual schema file error 2011 gets returned.

Errors

| | |
|------|---|
| 2000 | The authentic view object is no longer valid. |
| 2011 | AsXMLString was set to a value which is no valid XML for the current schema file. |

26.3.2.6.4 ContextMenu

Property: ContextMenu() as ContextMenu

Description

The property `ContextMenu` gives access to customize the context menu. The best place to do it is in the event handler `OnContextMenuActivated`.

Errors

| | |
|------|--------------------|
| 2000 | Invalid object. |
| 2005 | Invalid parameter. |

26.3.2.6.5 CreateXMLNode

Method: CreateXMLNode (*nKind* as [SPYXMLDataKind](#)¹⁴³⁵) as [XMLData](#)¹³⁷³

Return Value

The method returns the new [XMLData](#)¹³⁷³ object.

Description

To create a new XMLData object use the `CreateXMLNode()` method.

Errors

| | |
|------|-------------------------|
| 2000 | Invalid object. |
| 2012 | Cannot create XML node. |

26.3.2.6.6 DisableAttributeEntryHelper

Method: DisableAttributeEntryHelper ()

Description

`DisableAttributeEntryHelper ()` disables the attribute entry helper in XMLSpy, Authentic Desktop and Authentic Browser plug-in.

Errors

| | |
|------|-----------------|
| 2000 | Invalid object. |
|------|-----------------|

26.3.2.6.7 DisableElementEntryHelper

Method: DisableElementEntryHelper ()

Description

DisableElementEntryHelper () disables the element entry helper in XMLSpy, Authentic Desktop and Authentic Browser plug-in.

Errors

| | |
|------|-----------------|
| 2000 | Invalid object. |
|------|-----------------|

26.3.2.6.8 DisableEntityEntryHelper

Method: DisableEntityEntryHelper ()

Description

DisableEntityEntryHelper () disables the entity entry helper in XMLSpy, Authentic Desktop and Authentic Browser plug-in.

Errors

| | |
|------|-----------------|
| 2000 | Invalid object. |
|------|-----------------|

26.3.2.6.9 DocumentBegin

Property: DocumentBegin as [AuthenticRange](#)¹¹⁹⁹ (read-only)

Description

Retrieve a range object that points to the beginning of the document.

Errors

| | |
|------|---|
| 2000 | The authentic view object is no longer valid. |
| 2005 | Invalid address for the return parameter was specified. |

26.3.2.6.10 DocumentEnd

Property: DocumentEnd as [AuthenticRange](#)¹¹⁹⁹ (read-only)

Description

Retrieve a range object that points to the end of the document.

Errors

| | |
|------|---|
| 2000 | The authentic view object is no longer valid. |
| 2005 | Invalid address for the return parameter was specified. |

26.3.2.6.11 DoNotPerformStandardAction

Method: DoNotPerformStandardAction ()

Description

DoNotPerformStandardAction() serves as cancel bubble for macros, and stops further execution after macro has finished.

Errors

| | |
|------|-----------------|
| 2000 | Invalid object. |
|------|-----------------|

26.3.2.6.12 EvaluateXPath

Method: EvaluateXPath (XMLData as [XMLData](#)¹³⁷³, strExpression as string) strValue as string

Return Value

The method returns a string

Description

EvaluateXPath() executes an XPath expression with the given XML context node. The result is returned as a string, in the case of a sequence it is a space-separated string.

Errors

| | |
|------|--------------------|
| 2000 | Invalid object. |
| 2005 | Invalid parameter. |
| 2008 | Internal error. |
| 2013 | XPath error. |

26.3.2.6.13 Event

Property: Event as AuthenticEvent (read-only)

Description

This property gives access to parameters of the last event in the same way as OldAuthenticView.event does. Since all events for the scripting environment and external clients are now available with parameters this Event property should only be used from within IDE-Plugins.

Errors

| | |
|------|---|
| 2000 | The authentic view object is no longer valid. |
| 2005 | Invalid address for the return parameter was specified. |

26.3.2.6.14 EventContext

Property: EventContext() as EventContext

Description

EventContext property gives access to the running macros context. See the [EventContext](#)¹¹⁹⁶ interface description for more details.

Errors

| | |
|------|-----------------|
| 2000 | Invalid object. |
|------|-----------------|

26.3.2.6.15 GetToolBarButtonState

Method: GetToolBarButtonState (ButtonIdentifier as string) as AuthenticToolBarButtonState

Return Value

The method returns AuthenticToolBarButtonState

Description

Get/SetToolBarButtonState queries the status of a toolbar button, and lets the user disable or enable the button, identified via its button identifier ([see list above](#)¹²³⁷). One usage is to disable toolbar buttons permanently. Another usage is to put SetToolBarButtonState in the OnSelectionChanged event handler, as toolbar buttons are updated regularly when the selection changes in the document.

ToolBar button states are given by the [listed enumerations](#)¹⁴²⁴.

The default state means that the enable/disable of the button is governed by AuthenticView. When the user sets the button state to enable or disable, the button remains in that state as long as the user does not change it.

Errors

| | |
|------|----------------------------|
| 2000 | Invalid object. |
| 2005 | Invalid parameter. |
| 2008 | Internal error. |
| 2014 | Invalid button identifier. |

26.3.2.6.16 Goto

Method: Goto (eKind as SPYAuthenticElementKind¹⁴²⁴, nCount as Long, eFrom as SPYAuthenticDocumentPosition¹⁴²³) as AuthenticRange¹¹⁹⁹

Description

Retrieve a range object that points to the beginning of the *nCount* element of type *eKind*. The start position is defined by the parameter *eFrom*. Use positive values for *nCount* to navigate to the document end. Use negative values to navigate towards the beginning of the document.

Errors

| | |
|------|--|
| 2000 | The authentic view object is no longer valid. |
| 2003 | Target lies after end of document. |
| 2004 | Target lies before beginning of document. |
| 2005 | Invalid element kind specified.
The document position to start from is not one of <i>spyAuthenticDocumentBegin</i> or <i>spyAuthenticDocumentEnd</i> .
Invalid address for the return parameter was specified. |

Examples

```
'
'-----
' Scripting environment - VBScript
'-----

Dim objAuthenticView
' we assume that the active document is open in authentic view mode
Set objAuthenticView = Application.ActiveDocument.AuthenticView

On Error Resume Next
Dim objRange
' goto beginning of first table in document
Set objRange = objAuthenticView.Goto (spyAuthenticTable, 1, spyAuthenticDocumentBegin)
If (Err.number = 0) Then
    objRange.Select()
Else
    MsgBox "No table found in document"
End If
```

26.3.2.6.17 IsRedoEnabled

Property: IsRedoEnabled as Boolean (read-only)

Description

True if redo steps are available and [Redo](#)¹²⁴⁶ is possible.

Errors

| | |
|------|---|
| 2000 | The authentic view object is no longer valid. |
| 2005 | Invalid address for the return parameter was specified. |

26.3.2.6.18 IsUndoEnabled

Property: IsUndoEnabled as Boolean (read-only)

Description

True if undo steps are available and [Undo](#)¹²⁴⁷ is possible.

Errors

| | |
|------|---|
| 2000 | The authentic view object is no longer valid. |
| 2005 | Invalid address for the return parameter was specified. |

26.3.2.6.19 [MarkupVisibility](#)

Property: MarkupVisibility as [SPYAuthenticMarkupVisibility](#)¹⁴²⁴

Description

Set or get current visibility of markup.

Errors

| | |
|------|---|
| 2000 | The authentic view object is no longer valid. |
| 2005 | Invalid enumeration value was specified.
Invalid address for the return parameter was specified. |

26.3.2.6.20 [Parent](#)

Property: Parent as [Document](#)¹²⁶⁴ (read-only)

Description

Access the document shown in this view.

Errors

| | |
|------|---|
| 2000 | The authentic view object is no longer valid. |
| 2005 | Invalid address for the return parameter was specified. |

26.3.2.6.21 [Print](#)

Method: Print (*bWithPreview* as Boolean, *bPromptUser* as Boolean)

Description

Print the document shown in this view. If *bWithPreview* is set to *True*, the print preview dialog pops up. If *bPromptUser* is set to *True*, the print dialog pops up. If both parameters are set to *False*, the document gets printed without further user interaction.

Errors

| | |
|------|---|
| 2000 | The authentic view object is no longer valid. |
|------|---|

26.3.2.6.22 Redo

Method: Redo() as Boolean

Description

Redo the modification undone by the last undo command.

Errors

| | |
|------|---|
| 2000 | The authentic view object is no longer valid. |
| 2005 | Invalid address for the return parameter was specified. |

26.3.2.6.23 Selection

Property: Selection as [AuthenticRange](#)¹¹⁹⁹

Description

Set or get current text selection in user interface.

Errors

| | |
|------|---|
| 2000 | The authentic view object is no longer valid. |
| 2002 | No cursor selection is active. |
| 2005 | Invalid address for the return parameter was specified. |

Examples

```
' -----
' Scripting environment - VBScript
' -----
Dim objAuthenticView
' we assume that the active document is open in authentic view mode
Set objAuthenticView = Application.ActiveDocument.AuthenticView

' if we are the end of the document, re-start at the beginning
If (objAuthenticView.Selection.IsEqual(objAuthenticView.DocumentEnd)) Then
    objAuthenticView.Selection = objAuthenticView.DocumentBegin
Else
    ' objAuthenticView.Selection = objAuthenticView.Selection.GotoNextCursorPosition()
    ' or shorter:
    objAuthenticView.Selection.GotoNextCursorPosition().Select
End If
```

26.3.2.6.24 SetToolBarButtonState

Method: SetToolBarButtonState (ButtonIdentifier as string, AuthenticToolBarButtonState state)

Description

`Get/SetToolBarButtonState` queries the status of a toolbar button, and lets the user disable or enable the button, identified via its button identifier ([see list above](#)¹²³⁷). One usage is to disable toolbar buttons permanently. Another usage is to put `SetToolBarButtonState` in the `OnSelectionChanged` event handler, as toolbar buttons are updated regularly when the selection changes in the document.

Toolbar button states are given by the [listed enumerations](#)¹⁴²⁴.

The default state means that the enable/disable of the button is governed by `AuthenticView`. When the user sets the button state to enable or disable, the button remains in that state as long as the user does not change it.

Errors

| | |
|------|----------------------------|
| 2000 | Invalid object. |
| 2008 | Internal error. |
| 2014 | Invalid button identifier. |

26.3.2.6.25 Undo

Method: `Undo()` as Boolean

Description

Undo the last modification of the document from within this view.

Errors

| | |
|------|---|
| 2000 | The authentic view object is no longer valid. |
| 2005 | Invalid address for the return parameter was specified. |

26.3.2.6.26 UpdateXMLInstanceEntities

Method: `UpdateXMLInstanceEntities()`

Description

Updates the internal representation of the declared entities, and refills the entry helper. In addition, the validator is reloaded, allowing the XML file to validate correctly. Please note that this may also cause schema files to be reloaded.

Errors

The method never returns an error.

Example

```
// -----
// Scripting environment - JavaScript
// -----
if(Application.ActiveDocument && (Application.ActiveDocument.CurrentViewMode == 4))
{
    var objDocType;
```

```

objDocType = Application.ActiveDocument.DocEditView.XMLRoot.GetFirstChild(10);

if(objDocType)
{
    var objEntity = Application.ActiveDocument.CreateChild(14);
    objEntity.Name = "child";
    objEntity.TextValue = "SYSTEM \"child.xml\"";
    objDocType.AppendChild(objEntity);

    Application.ActiveDocument.AuthenticView.UpdateXMLInstanceEntities();
}
}

```

26.3.2.6.27 WholeDocument

Property: WholeDocument as [AuthenticRange](#)¹¹⁹⁹ (read-only)

Description

Retrieve a range object that selects the whole document.

Errors

| | |
|------|---|
| 2000 | The authentic view object is no longer valid. |
| 2005 | Invalid address for the return parameter was specified. |

26.3.2.6.28 XMLDataRoot

Property: XMLDataRoot as [XMLData](#)¹³⁷³ (read-only)

Description

Returns or sets the top-level XMLData element of the current document. This element typically describes the document structure and would be of kind spyXMLDataXMLDocStruct, spyXMLDataXMLEntityDocStruct or spyXMLDataDTDDocStruct..

Errors

| | |
|------|---|
| 2000 | The authentic view object is no longer valid. |
| 2005 | Invalid address for the return parameter was specified. |

26.3.2.7 CodeGeneratorDlg

Only available/enabled in the Enterprise edition. An error is returned, if accessed by any other version.

Properties and Methods

Standard automation properties

[Application](#)¹²⁴⁹

[Parent](#)¹²⁵³

Programming language selection properties

[ProgrammingLanguage](#)¹²⁵³
[TemplateFileName](#)¹²⁵⁴

Settings for C++ code

[CPPSettings_DOMType](#)¹²⁵⁰
[CPPSettings_LibraryType](#)¹²⁵¹
[CPPSettings_UseMFC](#)¹²⁵¹
[CPPSettings_GenerateVC6ProjectFile](#)¹²⁵⁰
[CPPSettings_GenerateVSProjectFile](#)¹²⁵¹

Settings for C# code

[CSharpSettings_ProjectType](#)¹²⁵²

Dialog handling for above code generation properties

[PropertySheetDialogAction](#)¹²⁵⁴

Output path selection properties

[OutputPath](#)¹²⁵²
[OutputPathDialogAction](#)¹²⁵²

Presentation of result

[OutputResultDialogAction](#)¹²⁵³

Description

Use this object to configure the generation of program code for schema files. The method [GenerateProgramCode](#)¹²⁸¹ expects a CodeGeneratorDlg as parameter to configure code generation as well as the associated user interactions.

26.3.2.7.1 Application

Only available/enabled in the Enterprise edition. An error is returned, if accessed by any other version.

Property: Application as [Application](#)¹¹⁷² (read-only)

Description

Access the XMLSpy application object.

Errors

| | |
|------|---|
| 2200 | The object is no longer valid. |
| 2201 | Invalid address for the return parameter was specified. |

26.3.2.7.2 CompatibilityMode (obsolete)

Property: CompatibilityMode as Boolean

Only available/enabled in the Enterprise edition. An error is returned, if accessed by any other version.

Description

Set to true to generate code compatible to XMLSpy 2005R3. Set to false to use newly added code-generation features.

Errors

| | |
|------|--|
| 2200 | The object is no longer valid. |
| 2201 | Invalid action passed as parameter or an invalid address was specified for the return parameter. |

26.3.2.7.3 CPPSettings_DOMType

Property: CPPSettings_DOMType as [SPYDOMType](#)¹⁴²⁵

Only available/enabled in the Enterprise edition. An error is returned, if accessed by any other version.

Description

Defines one of the settings that configure generation of C++ code.

Errors

| | |
|------|--|
| 2200 | The object is no longer valid. |
| 2201 | Invalid action passed as parameter or an invalid address was specified for the return parameter. |

26.3.2.7.4 CPPSettings_GenerateVC6ProjectFile

Property: CPPSettings_GenerateVC6ProjectFile as Boolean

Only available/enabled in the Enterprise edition. An error is returned, if accessed by any other version.

Description

Defines one of the settings that configure generation of C++ code.

Errors

| | |
|------|--|
| 2200 | The object is no longer valid. |
| 2201 | Invalid action passed as parameter or an invalid address was specified for the return parameter. |

26.3.2.7.5 CPPSettings_GenerateGCCMakefile

Property: CPPSettings_GenerateGCCMakefile as Boolean

Only available/enabled in the Enterprise edition. An error is returned, if accessed by any other version.

Description

Creates makefiles to compile the generated code under Linux with GCC.

Errors

| | |
|------|--|
| 2200 | The object is no longer valid. |
| 2201 | Invalid action passed as parameter or an invalid address was specified for the return parameter. |

26.3.2.7.6 CPPSettings_GenerateVSProjectFile

Property: CSharpSettings_GenerateVSProjectFile as [SPYProjectType](#)¹⁴³⁰
 Only available/enabled in the Enterprise edition. An error is returned, if accessed by any other version.

Description

Defines one of the settings that configure generation of C++ code. Only `spyVisualStudio2005Project (=4)` and `spyVisualStudio2008Project (=5)` and `spyVisualStudio2010Project (=6)` are valid project types.

Errors

| | |
|------|--|
| 2200 | The object is no longer valid. |
| 2201 | Invalid action passed as parameter or an invalid address was specified for the return parameter. |

26.3.2.7.7 CPPSettings_LibraryType

Property: CPPSettings_LibraryType as [SPYLibType](#)¹⁴²⁸
 Only available/enabled in the Enterprise edition. An error is returned, if accessed by any other version.

Description

Defines one of the settings that configure generation of C++ code.

Errors

| | |
|------|--|
| 2200 | The object is no longer valid. |
| 2201 | Invalid action passed as parameter or an invalid address was specified for the return parameter. |

26.3.2.7.8 CPPSettings_UseMFC

Property: CPPSettings_UseMFC as Boolean
 Only available/enabled in the Enterprise edition. An error is returned, if accessed by any other version.

Description

Defines one of the settings that configure generation of C++ code.

Errors

| | |
|------|--|
| 2200 | The object is no longer valid. |
| 2201 | Invalid action passed as parameter or an invalid address was specified for the return parameter. |

26.3.2.7.9 CSharpSettings_ProjectType

Property: CSharpSettings_ProjectType as [SPYProjectType](#)¹⁴³⁰

Only available/enabled in the Enterprise edition. An error is returned, if accessed by any other version.

Description

Defines the only setting to configure generation of C# code.

Errors

| | |
|------|--|
| 2200 | The object is no longer valid. |
| 2201 | Invalid action passed as parameter or an invalid address was specified for the return parameter. |

26.3.2.7.10 OutputPath

Property: OutputPath as String

Only available/enabled in the Enterprise edition. An error is returned, if accessed by any other version.

Description

Selects the base directory for all generated code.

Errors

| | |
|------|---|
| 2200 | The object is no longer valid. |
| 2201 | Invalid address for the return parameter was specified. |

26.3.2.7.11 OutputPathDialogAction

Property: OutputPathDialogAction as [SPYDialogAction](#)¹⁴²⁵

Only available/enabled in the Enterprise edition. An error is returned, if accessed by any other version.

Description

Defines how the sub-dialog for selecting the code generation output path gets handled. Set this value to *spyDialogUserInput(2)* to show the dialog with the current value of the [OutputPath](#)¹²⁵² property as default. Use *spyDialogOK(0)* to hide the dialog from the user.

Errors

| | |
|------|--|
| 2200 | The object is no longer valid. |
| 2201 | Invalid action passed as parameter or an invalid address was specified for the return parameter. |

26.3.2.7.12 OutputResultDialogAction

Property: OutputResultDialogAction as [SPYDialogAction](#)¹⁴²⁵

Only available/enabled in the Enterprise edition. An error is returned, if accessed by any other version.

Description

Defines how the sub-dialog that asks to show the result of the code generation process gets handled. Set this value to *spyDialogUserInput(2)* to show the dialog. Use *spyDialogOK(0)* to hide the dialog from the user.

Errors

| | |
|------|--|
| 2200 | The object is no longer valid. |
| 2201 | Invalid action passed as parameter or an invalid address was specified for the return parameter. |

26.3.2.7.13 Parent

Only available/enabled in the Enterprise edition. An error is returned, if accessed by any other version.

Property: Parent as [Dialogs](#)¹²⁶¹ (read-only)

Description

Access the parent of the object.

Errors

| | |
|------|---|
| 2200 | The object is no longer valid. |
| 2201 | Invalid address for the return parameter was specified. |

26.3.2.7.14 ProgrammingLanguage

Property: ProgrammingLanguage as [ProgrammingLanguage](#)¹⁴²⁹

Only available/enabled in the Enterprise edition. An error is returned, if accessed by any other version.

Description

Selects the output language for the code to be generated.

CAUTION: Setting this property to one of C++, C# or Java, changes the property [TemplateFileName](#)¹²⁵⁴ to the appropriate template file delivered with XMLSpy as well. If you want to generate C++, C# or Java code based on your own templates, set first the programming language and then select your template file.

Errors

| | |
|------|---|
| 2200 | The object is no longer valid. |
| 2201 | Invalid address for the return parameter was specified. |

26.3.2.7.15 PropertySheetDialogAction

Property: PropertySheetDialogAction as [SPYDialogAction](#)¹⁴²⁵

Only available/enabled in the Enterprise edition. An error is returned, if accessed by any other version.

Description

Defines how the sub-dialog that configures the code generation process gets handled. Set this value to *spyDialogUserInput(2)* to show the dialog with the current values as defaults. Use *spyDialogOK(0)* to hide the dialog from the user.

Errors

| | |
|------|--|
| 2200 | The object is no longer valid. |
| 2201 | Invalid action passed as parameter or an invalid address was specified for the return parameter. |

26.3.2.7.16 TemplateFileName

Property: TemplateFileName as String

Only available/enabled in the Enterprise edition. An error is returned, if accessed by any other version.

Description

Selects the code generation template file. XMLSpy comes with template files for C++, C# or Java in the SPL folder of your installation directory.

Setting this property to one of the code generation template files of your XMLSpy installation automatically sets the [ProgrammingLanguage](#)¹²⁵³ property to its appropriate value.

Errors

| | |
|------|---|
| 2200 | The object is no longer valid. |
| 2201 | Invalid address for the return parameter was specified. |

26.3.2.8 DatabaseConnection

Properties for import and export

[File](#)¹²⁵⁷ or

[ADOConnection](#)¹²⁵⁵ or

[ODBCConnection](#)¹²⁵⁹

Properties for import only

[DatabaseKind](#)¹²⁵⁷

[SQLSelect](#)¹²⁶⁰

[AsAttributes](#)¹²⁵⁶

[ExcludeKeys](#)¹²⁵⁷

[IncludeEmptyElements](#)¹²⁵⁸

[NumberDateTimeFormat](#)¹²⁵⁹

[NullReplacement](#)¹²⁵⁸

[CommentIncluded](#) ¹²⁵⁶

Properties for export only

[CreateMissingTables](#) ¹²⁵⁶

[CreateNew](#) ¹²⁵⁶

[TextFieldLen](#) ¹²⁶⁰

[DatabaseSchema](#) ¹²⁵⁷

Properties for XML Schema from DB Structure generation

[PrimaryKeys](#) ¹²⁵⁹

[ForeignKeys](#) ¹²⁵⁸

[UniqueKeys](#) ¹²⁶⁰

[SchemaExtensionType](#) ¹²⁵⁹

[SchemaFormat](#) ¹²⁶⁰

[ImportColumnsType](#) ¹²⁵⁸

Description

DatabaseConnection specifies the parameters for the database connection.

Please note that the properties of the DatabaseConnection interface are referring to the settings of the import and export dialogs of XMLSpy.

26.3.2.8.1 ADOConnection

Property: ADOConnection as String

Description

The property ADOConnection contains a connection string. Either use this property or [ODBCConnection](#) ¹²⁵⁹ or [File](#) ¹²⁵⁷ to refer to a database.

Errors

No error codes are returned.

Example

```
Dim objSpyConn As DatabaseConnection
Set objSpyConn = objSpy.GetDatabaseSettings

Dim objADO As DataLinks
Set objADO = CreateObject("DataLinks")

If Not (objADO Is Nothing) Then
    Dim objConn As Connection
    Set objConn = objADO.PromptNew
    objSpyConn.ADOConnection = objConn.ConnectionString
End If
```

26.3.2.8.2 AsAttributes

Property: AsAttributes as Boolean

Description

Set AsAttributes to true if you want to initialize all import fields to be imported as attributes. Default is false and will initialize all fields to be imported as elements. This property is used only in calls to [Application.GetDatabaseImportElementList](#)¹¹⁷⁹.

Errors

No error codes are returned.

26.3.2.8.3 CommentIncluded

Property: CommentIncluded as Boolean

Description

This property tells whether additional comments are added to the generated XML. Default is true. This property is used only when importing from databases.

Errors

No error codes are returned.

26.3.2.8.4 CreateMissingTables

Property: CreateMissingTables as Boolean

Description

If CreateMissingTables is true, tables which are not already defined in the export database will be created during export. Default is true. This property is used only when exporting to databases.

Errors

No error codes are returned.

26.3.2.8.5 CreateNew

Property: CreateNew as Boolean

Description

Set CreateNew true if you want to create a new database on export. Any existing database will be overwritten. See also [DatabaseConnection.File](#)¹²⁵⁷. Default is false. This property is used only when exporting to databases.

Errors

No error codes are returned.

26.3.2.8.6 DatabaseKind

Property: DatabaseKind as [SPYDatabaseKind](#)¹⁴²⁵

Description

Select the kind of database that gets access. The default value is spyDB_Unspecified(7) and is sufficient in most cases. This property is used only when importing from databases.

Errors

No error codes are returned.

26.3.2.8.7 DatabaseSchema

Property: DatabaseSchema as String

Description

This property specifies the Schema used for export in Schema aware databases. Default is "". This property is used only when exporting to databases.

Errors

No error codes are returned.

26.3.2.8.8 ExcludeKeys

Property: ExcludeKeys as Boolean

Description

Set ExcludeKeys to true if you want to exclude all key columns from the import data. Default is false. This property is used only when importing from databases.

Errors

No error codes are returned.

26.3.2.8.9 File

Property: File as String

Description

The property File sets the path for the database during export or import. This property can only be used in conjunction with a Microsoft Access database. Either use this property or [ODBCConnection](#)¹²⁵⁹ or [ADOConnection](#)¹²⁵⁹ to refer to the database.

See also [Import and Export](#)¹¹⁴².

Errors

No error codes are returned.

26.3.2.8.10 ForeignKeys

Property: ForeignKeys as Boolean

Description

Specifies whether the Foreign Keys constraint is created or not. Default is true. This property is used only when creating a XML Schema from a DB structure.

Errors

No error codes are returned.

26.3.2.8.11 ImportColumnsType

Property: ImportColumnsType as [SPYImportColumnsType](#)¹⁴²⁷

Description

Defines if column information from the DB is saved as element or attribute in the XML Schema. Default is as element. This property is used only when creating a XML Schema from a DB structure.

Errors

No error codes are returned.

26.3.2.8.12 IncludeEmptyElements

Property: IncludeEmptyElements as Boolean

Description

Set IncludeEmptyElements to false if you want to exclude all empty elements. Default is true. This property is used only when importing from databases.

Errors

No error codes are returned.

26.3.2.8.13 NullReplacement

Property: NullReplacement as String

Description

This property contains the text value that is used during import for empty elements (null values). Default is "". This property is used only when importing from databases.

Errors

No error codes are returned.

26.3.2.8.14 NumberDateTimeFormat

Property: NumberDateTimeFormat as [SPYNumberDateTimeFormat](#)¹⁴²⁹

Description

The property NumberDateTimeFormat sets the format of numbers and date- and time-values. Default is [spySystemLocale](#)¹⁴²⁹. This property is used only when importing from databases.

Errors

No error codes are returned.

26.3.2.8.15 ODBCConnection

Property: ODBCConnection as String

Description

The property ODBCConnection contains a ODBC connection string. Either use this property or [ADOConnection](#)¹²⁵⁵ or [File](#)¹²⁵⁷ to refer to a database.

Errors

No error codes are returned.

26.3.2.8.16 PrimaryKeys

Property: PrimaryKeys as Boolean

Description

Specifies whether the Primary Keys constraint is created or not. Default is true. This property is used only when creating a XML Schema from a DB structure.

Errors

No error codes are returned.

26.3.2.8.17 SchemaExtensionType

Property: SchemaExtensionType as [SPYSchemaExtensionType](#)¹⁴³²

Description

Defines the Schema extension type used during the Schema generation. This property is used only when creating a XML Schema from a DB structure.

See also [Create XML Schema from DB Structure](#)⁹⁶⁹.

Errors

No error codes are returned.

26.3.2.8.18 SchemaFormat

Property: SchemaFormat as [SPYSchemaFormat](#) ¹⁴³²

Description

Defines the Schema format used during the Schema generation. This property is used only when creating a XML Schema from a DB structure.

See also [Create XML Schema from DB Structure](#) ⁹⁶⁹.

Errors

No error codes are returned.

26.3.2.8.19 SQLSelect

Property: SQLSelect as String

Description

The SQL query for the import is stored in the property SQLSelect. This property is used only when importing from databases. See also [Import and Export](#) ¹¹⁴².

Errors

No error codes are returned.

26.3.2.8.20 TextFieldLen

Property: TextFieldLen as long

Description

The property TextFieldLen sets the length for created text fields during the export. Default is 255. This property is used only when exporting to databases.

Errors

No error codes are returned.

26.3.2.8.21 UniqueKeys

Property: UniqueKeys as Boolean

Description

Specifies whether the Unique Keys constraint is created or not. Default is true. This property is used only when creating a XML Schema from a DB structure.

Errors

No error codes are returned.

26.3.2.9 Dialogs

Properties and Methods

Standard automation properties

[Application](#)¹²⁶¹
[Parent](#)¹²⁶²

Various dialog objects

[CodeGeneratorDlg](#)¹²⁶¹
[FileSelectionDlg](#)¹²⁶²
[SchemaDocumentationDlg](#)¹²⁶³
[GenerateSampleXMLDlg](#)¹²⁶³
[DTDSchemaGeneratorDlg](#)¹²⁶³
[FindInFilesDlg](#)¹²⁶³

Description

The Dialogs object provides access to different built-in dialogs of XMLSpy. These dialog objects allow to initialize the fields of user dialogs before they get presented to the user or allow to simulate complete user input by your program.

26.3.2.9.1 Application

Property: Application as [Application](#)¹¹⁷² (read-only)

Description

Access the XMLSpy application object.

Errors

| | |
|------|---|
| 2300 | The object is no longer valid. |
| 2301 | Invalid address for the return parameter was specified. |

26.3.2.9.2 CodeGeneratorDlg

Only available/enabled in the Enterprise edition. An error is returned, if accessed by any other version.

Property: CodeGeneratorDlg as [CodeGeneratorDlg](#)¹²⁴⁸ (read-only)

Description

Get a new instance of a code generation dialog object. You will need this object to pass the necessary parameters to the code generation methods. Initial values are taken from last usage of the code generation dialog.

Errors

| | |
|------|--|
| 2300 | The Dialogs object or one of its parents is no longer valid. |
|------|--|

| | |
|------|---|
| 2301 | Invalid address for the return parameter was specified. |
|------|---|

26.3.2.9.3 FileSelectionDlg

Property: FileSelectionDlg as [FileSelectionDlg](#)¹³⁰⁸ (read-only)

Description

Get a new instance of a file selection dialog object.

File selection dialog objects are passed to you with the some events that signal opening or saving of documents and projects.

Errors

| | |
|------|--|
| 2300 | The Dialogs object or one of its parents is no longer valid. |
| 2301 | Invalid address for the return parameter was specified. |

26.3.2.9.4 JSONSchemaDocumentationDlg

Property: JSONSchemaDocumentationDlg as [JSONSchemaDocumentationDlg](#)¹³³¹ (read-only)

Description

Get a new instance of a dialog object that parameterizes generation of JSON Schema documentation. See [Document.GenerateJSONSchemaDocumentation](#)¹²⁸¹ for its usage.

Errors

| | |
|------|--|
| 2300 | The Dialogs object or one of its parents is no longer valid. |
| 2301 | Invalid address for the return parameter was specified. |

26.3.2.9.5 Parent

Property: Parent as [Application](#)¹¹⁷² (read-only)

Description

Access the XMLSpy application object.

Errors

| | |
|------|---|
| 2300 | The object is no longer valid. |
| 2301 | Invalid address for the return parameter was specified. |

26.3.2.9.6 SchemaDocumentationDlg

Property: SchemaDocumentationDlg as [SchemaDocumentationDlg](#)¹³⁴⁵ (read-only)

Description

Get a new instance of a dialog object that parameterizes generation of schema documentation. See [Document.GenerateSchemaDocumentation](#)¹²⁸² for its usage.

Errors

| | |
|------|--|
| 2300 | The Dialogs object or one of its parents is no longer valid. |
| 2301 | Invalid address for the return parameter was specified. |

26.3.2.9.7 GenerateSampleXMLDlg

Property: GenerateSampleXMLDlg as [GenerateSampleXMLDlg](#)¹³²² (read-only)

Description

Get a new instance of a dialog object that parameterizes generation of a sample XML based on a W3C schema or DTD. See [GenerateSampleXML](#)¹²⁸¹ for its usage.

Errors

| | |
|------|--|
| 2300 | The Dialogs object or one of its parents is no longer valid. |
| 2301 | Invalid address for the return parameter was specified. |

26.3.2.9.8 DTDSchemaGeneratorDlg

Property: DTDSchemaGeneratorDlg as [DTDSchemaGeneratorDlg](#)¹²⁹⁹ (read-only)

Description

Get a new instance of a dialog object that parameterizes generation of a schema or DTD. See [Document.GenerateDTDOrSchemaEx](#)¹²⁸⁰ for its usage.

Errors

| | |
|------|--|
| 2300 | The Dialogs object or one of its parents is no longer valid. |
| 2301 | Invalid address for the return parameter was specified. |

26.3.2.9.9 FindInFilesDlg

Property: FindInFilesDlg as [FindInFilesDlg](#)¹³¹⁰ (read-only)

Description

Get a new instance of a dialog object that parameterizes the search (or replacement) of strings in files. See [Application.FindInFiles](#)¹¹⁷³ for its usage.

Errors

| | |
|------|--|
| 2300 | The Dialogs object or one of its parents is no longer valid. |
| 2301 | Invalid address for the return parameter was specified. |

26.3.2.10 Document

The `Document` interface has the following properties and methods.

Properties and Methods

Standard automation properties

[Application](#) ¹²⁶⁹

[Parent](#) ¹²⁸⁷

Various document properties and methods

[AsXMLString](#) ¹²⁷⁰

[SetActiveDocument](#) ¹²⁹⁰

[Encoding](#) ¹²⁷⁵

[SetEncoding \(obsolete\)](#) ¹²⁹⁰

[Suggestions](#) ¹²⁹²

[Selection](#) ¹²⁹⁰

XML validation

[IsValid](#) ¹²⁸⁴

[IsValidEx](#) ¹²⁸⁵

[SetExternalsIsValid](#) ¹²⁹¹

[IsWellFormed](#) ¹²⁸⁶

[ValidateOnServer](#) ¹²⁹⁵

Document conversion and transformation

[AssignDTD](#) ¹²⁶⁹

[AssignSchema](#) ¹²⁶⁹

[AssignXSL](#) ¹²⁶⁹

[AssignXSLFO](#) ¹²⁷⁰

[ConvertDTDOrSchema](#) ¹²⁷¹

[ConvertDTDOrSchemaEx](#) ¹²⁷²

[ConvertXMLToFromJSON](#) ¹²⁷³

[GenerateDTDOrSchema](#) ¹²⁸⁰

[GenerateDTDOrSchemaEx](#) ¹²⁸⁰

[FlattenDTDOrSchema](#) ¹²⁷⁹

[CreateSchemaDiagram](#) ¹²⁷⁴

[ExecuteXQuery](#) ¹²⁷⁶

[TransformXSL](#) ¹²⁹³

[TransformXSLEx](#) ¹²⁹³

[TransformXSLFO](#) ¹²⁹³

[TransformXSLFOEx](#) ¹²⁹⁴

[GenerateProgramCode](#) ¹²⁸¹ (Enterprise Edition only)

[GenerateSchemaDocumentation](#) ¹²⁸²

[GenerateSampleXML](#) ¹²⁸¹

[GenerateJSONSchemaDocumentation](#) ¹²⁸¹
[ConvertToWSDL20](#) ¹²⁷³

Document export

[GetExportElementList](#) ¹²⁸³
[ExportToText](#) ¹²⁷³
[ExportToDatabase](#) ¹²⁷⁷
[CreateDBStructureFromXMLSchema](#) ¹²⁷⁴
[GetDBStructureList](#) ¹²⁸²

File saving and naming

[FullName](#) ¹²⁷³
[Name](#) ¹²⁸⁷
[Path](#) ¹²⁸⁷
[GetPathName \(obsolete\)](#) ¹²⁸³
[SetPathName \(obsolete\)](#) ¹²⁹¹
[Title](#) ¹²⁹³
[IsModified](#) ¹²⁸⁴
[Saved](#) ¹²⁸³
[SaveAs](#) ¹²⁸⁸
[Save](#) ¹²⁸⁸
[SaveInString](#) ¹²⁸⁹
[SaveToURL](#) ¹²⁸³
[Close](#) ¹²⁷¹

View access

[CurrentViewMode](#) ¹²⁷⁵
[SwitchViewMode](#) ¹²⁹²
[TextView](#) ¹²⁹²
[AuthenticView](#) ¹²⁷⁰
[GridView](#) ¹²⁸⁴
[DocEditView \(obsolete\)](#) ¹²⁷⁵

Access to XMLData

[RootElement](#) ¹²⁸³
[DataRoot](#) ¹²⁷⁵
[CreateChild](#) ¹²⁷³
[UpdateViews](#) ¹²⁹⁴
[StartChanges](#) ¹²⁹¹
[EndChanges](#) ¹²⁷⁶
[UpdateXMLData](#) ¹²⁹⁴

Document objects

Document objects represent XML documents opened in XMLSpy.

Use one of the following properties to access documents that are already open XMLSpy:

[Application.ActiveDocument](#) ¹¹⁷⁵
[Application.Documents](#) ¹¹⁷³

Use one of the following methods to open a new document in XMLSpy:

[Documents.OpenFile](#) ¹²⁹⁸
[Documents.OpenURL](#) ¹²⁹⁸

[Documents.OpenURLDialog](#)¹²⁹⁹
[Documents.NewFile](#)¹²⁹⁷
[Documents.NewFileFromText](#)¹²⁹⁷
[SpyProjectItem.Open](#)¹³⁶¹
[Application.ImportFromDatabase](#)¹¹⁸³
[Application.ImportFromSchema](#)¹¹⁸⁴
[Application.ImportFromText](#)¹¹⁸⁵
[Application.ImportFromWord](#)¹¹⁸⁵
[Document.ConvertDTDOrSchema](#)¹²⁷¹
[Document.GenerateDTDOrSchema](#)¹²⁸⁰

26.3.2.10.1 Events

26.3.2.10.1.1 OnBeforeSaveDocument

Event: OnBeforeSaveDocument(*objDocument* as [Document](#)¹²⁶⁴, *objDialog* as [FileSelectionDlg](#)¹³⁰⁸)

XMLSpy scripting environment - VBScript:

```
Function On_BeforeSaveDocument(objDocument, objDialog)
End Function
```

```
' old handler - now obsolete
' return string to save to new file name
' return empty string to cancel save operation
' return nothing to save to original name
Function On_SaveDocument(objDocument, strFilePath)
End Function
```

XMLSpy scripting environment - JScript:

```
function On_BeforeSaveDocument(objDocument, objDialog)
{
}
```

```
// old handler - now obsolete
// return string to save to new file name
// return empty string to cancel save operation
// return nothing to save to original name
function On_SaveDocument(objDocument, strFilePath)
{
}
```

XMLSpy IDE Plugin:

```
IXMLSpyPlugIn.OnEvent (27, ...) // nEventId = 27
```

Description

This event gets fired on any attempt to save a document. The file selection dialog object is initialized with the name chosen for the document file. You can modify this selection. To continue saving the document leave the [FileSelectionDlg.DialogAction](#)¹³⁰⁸ property of *io_objDialog* at its default value [spyDialogOK](#)¹⁴²⁵. To abort saving of the document set this property to [spyDialogCancel](#)¹⁴²⁵.

26.3.2.10.1.2 OnBeforeCloseDocument

Event: OnBeforeCloseDocument(*objDocument* as [Document](#)¹²⁶⁴) as Boolean

XMLSpy scripting environment - VBScript:

```
Function On_BeforeCloseDocument(objDocument)
    ' On_BeforeCloseDocument = False ' to prohibit closing of document
End Function
```

XMLSpy scripting environment - JScript:

```
function On_BeforeCloseDocument(objDocument)
{
    // return false; /* to prohibit closing of document */
}
```

XMLSpy IDE Plugin:

```
IXMLSpyPlugIn.OnEvent (28, ...) // nEventId = 28
```

Description

This event gets fired on any attempt to close a document. To prevent the document from being closed return false.

26.3.2.10.1.3 OnBeforeValidate

Event: OnBeforeValidate(*objDocument* as [Document](#)¹²⁶⁴, *bOnLoading* as Boolean, *bOnCommand* as Boolean) as Boolean

XMLSpy scripting environment - VBScript:

```
Function On_BeforeValidate(objDocument, bOnLoading, bOnCommand)
    On_BeforeValidate = bCancelDefaultValidation 'set by the script if necessary
End Function
```

XMLSpy scripting environment - JScript:

```
function On_BeforeValidate(objDocument, bOnLoading, bOnCommand)
{
    return bCancelDefaultValidation //set by the script if necessary
}
```

XMLSpy IDE Plugin:

```
IXMLSpyPlugIn.OnEvent (32, ...) // nEventId = 32
```

Description

This event gets fired before the document is validated. It is possible to suppress the default validation by returning false from the event handler. In this case the script should also set the validation result using the [SetExternallsValid](#)¹²⁹¹ method.

bOnLoading is true if the event is raised on the initial validation on loading the document.

bOnCommand is true whenever the user selected the Validate command from the Toolbar or menu.

Available with TypeLibrary version 1.5

26.3.2.10.1.4 OnCloseDocument

Event: OnCloseDocument(*objDocument* as [Document](#)¹²⁶⁴)

XMLSpy scripting environment - VBScript:

```
Function On_Close Document(objDocument)  
End Function
```

XMLSpy scripting environment - JScript:

```
function On_Close Document(objDocument)  
{  
}  
}
```

XMLSpy IDE Plugin:

```
IXMLSpyPlugIn.OnEvent (8, ...) // nEventId = 8
```

Description

This event gets fired as a result of closing a document. Do not modify the document from within this event.

26.3.2.10.1.5 OnViewActivation

Event: OnViewActivation(*objDocument* as [Document](#)¹²⁶⁴, *eViewMode* as [SPYViewModes](#)¹⁴³⁴, *bActivated* as Boolean)

XMLSpy scripting environment - VBScript:

```
Function On_ViewActivation(objDocument, eViewMode, bActivated)  
End Function
```

XMLSpy scripting environment - JScript:

```
function On_ViewActivation(objDocument, eViewMode, bActivated)  
{  
}  
}
```

XMLSpy IDE Plugin:

```
IXMLSpyPlugIn.OnEvent (29, ...) // nEventId = 29
```

Description

This event gets fired whenever a view of a document becomes visible (i.e. becomes the active view) or invisible (i.e. another view becomes the active view or the document gets closed). However, the first view activation event after a document gets opened cannot be received, since there is no document object to get the event from. Use the [Application.OnDocumentOpened](#)¹¹⁷⁴ event instead.

26.3.2.10.2 Application

Property: Application as [Application](#)¹¹⁷² (read-only)

Description

Accesses the XMLSpy application object.

Errors

| | |
|------|---|
| 1400 | The object is no longer valid. |
| 1407 | Invalid address for the return parameter was specified. |

26.3.2.10.3 AssignDTD

Method: AssignDTD(*strDTDFile* as String, *bDialog* as Boolean)

Description

The method places a reference to the DTD file "strDTDFile" into the document. Note that no error occurs if the file does not exist, or is not accessible. If bDialog is true XMLSpy presents a dialog to set the file.

Errors

| | |
|------|--|
| 1400 | The object is no longer valid. |
| 1409 | You are not allowed to assign a DTD to the document. |

26.3.2.10.4 AssignSchema

Method: AssignSchema (*strSchemaFile* as String, *bDialog* as Boolean)

Description

The method places a reference to the schema file "strSchemaFile" into the document. Note that no error occurs if the file does not exist or is not accessible. If bDialog is true XMLSpy presents a dialog to set the file.

Errors

| | |
|------|--|
| 1400 | The object is no longer valid. |
| 1409 | You are not allowed to assign a schema file to the document. |

26.3.2.10.5 AssignXSL

Method: AssignXSL (*strXSLFile* as String, *bDialog* as Boolean)

Description

The method places a reference to the XSL file "strXSLFile" into the document. Note that no error occurs if the file does not exist or is not accessible. If bDialog is true XMLSpy presents a dialog to set the file.

Errors

| | |
|------|--|
| 1400 | The object is no longer valid. |
| 1409 | You are not allowed to assign an XSL file to the document. |

26.3.2.10.6 AssignXSLFO

Method: AssignXSLFO (*strXSLFOFile* as String, *bDialog* as Boolean)

Description

The method places a reference to the XSLFO file "strXSLFile" into the document. Note that no error occurs if the file does not exist or is not accessible. If *bDialog* is true XMLSpy presents a dialog to set the file.

Errors

| | |
|------|--|
| 1400 | The object is no longer valid. |
| 1409 | You are not allowed to assign an XSL file to the document. |

26.3.2.10.7 AsXMLString

Property: AsXMLString as String

Description

This property can be used to get or set the document content.

Errors

| | |
|------|---|
| 1400 | The document object is no longer valid. |
| 1404 | Cannot create XMLData object. |
| 1407 | View mode cannot be switched. |

26.3.2.10.8 AuthenticView

Method: AuthenticView as [AuthenticView](#)¹²²³ (read-only)

Description

Returns an object that gives access to properties and methods specific to Authentic view. The object returned is only valid if the current document is opened in Authentic view mode. The lifetime of an object ends with the next view switch. Any attempt to access objects or any of its children afterwards will result in an error indicating that the object is invalid.

[AuthenticView](#)¹²²³ and [DocEditView](#)¹⁴⁰⁰ both provide automation access to the Authentic view mode of XMLSpy. Functional overlap is intentional. A future version of Authentic View will include all functionality of [DocEditView](#)¹⁴⁰⁰ and its sub-objects, thereby making usage of [DocEditView](#)¹⁴⁰⁰ obsolete.

Errors

| | |
|------|---|
| 1400 | The object is no longer valid. |
| 1417 | Document needs to be open in authentic view mode. |

Examples

```

' -----
' XMLSpy scripting environment - VBScript
' secure access to authentic view object
' -----
Dim objDocument
Set objDocument = Application.ActiveDocument
If (Not objDocument Is Nothing) Then
    ' we have an active document, now check for view mode
    If (objDocument.CurrentViewMode <> spyViewAuthentic) Then
        If (Not objDocument.SwitchViewMode (spyViewAuthentic)) Then
            MsgBox "Active document does not support authentic view mode"
        Else
            ' now it is safe to access the authentic view object
            Dim objAuthenticView
            Set objAuthenticView = objDocument.AuthenticView
            ' now use the authentic view object

        End If
    End If
Else
    MsgBox "No document is open"
End If
    
```

26.3.2.10.9 Close

Method: Close (*bDiscardChanges* as Boolean)

Description

To close the document call this method. If *bDiscardChanges* is true and the document is modified, the document will be closed but not saved.

Errors

| | |
|------|-----------------------------------|
| 1400 | The object is no longer valid. |
| 1401 | Document needs to be saved first. |

26.3.2.10.10 ConvertDTDOrSchema

Method: ConvertDTDOrSchema (*nFormat* as [SPYDTDSchemaFormat](#)¹⁴²⁶, *nFrequentElements* as [SPYFrequentElements](#)¹⁴²⁶)

Parameters

nFormat

Sets the schema output format to DTD or W3C.

nFrequentElements

Create complex elements as elements or complex types.

Description

ConvertDTDOrSchema takes an existing schema format and converts it into a different format. For a finer tuning of DTD/XSD conversion, use [ConvertDTDOrSchemaEx](#)¹²⁷².

Errors

| | |
|------|---|
| 1400 | The object is no longer valid. |
| 1412 | Error during conversion. In the case of DTD to DTD or XSD to XSD conversion, the following errors are returned: <i>DTD to DTD conversion is not supported. Please use function FlattenDTDOrSchema instead and Schema to schema conversion is not supported. Please use function FlattenDTDOrSchema instead.</i> |

26.3.2.10.11 ConvertDTDOrSchemaEx

Method: ConvertDTDOrSchemaEx (*nFormat* as [SPYDTDSchemaFormat](#)¹⁴²⁶, *nFrequentElements* as [SPYFrequentElements](#)¹⁴²⁶, *sOutputPath* as String, *nOutputPathDialogAction* as [SPYDialogAction](#)¹⁴²⁵)

Parameters

nFormat

Sets the schema output format to DTD, or W3C.

nFrequentElements

Create complex elements as elements or complex types.

sOutputPath

The file path for the newly generated file.

nOutputPathDialogAction

Defines the dialog interaction for this call.

Description

ConvertDTDOrSchemaEx takes an existing schema format and converts it into a different format.

Errors

| | |
|------|---|
| 1400 | The object is no longer valid. |
| 1412 | Error during conversion. In the case of DTD to DTD or XSD to XSD conversion, the following errors are returned: <i>DTD to DTD conversion is not supported. Please use function FlattenDTDOrSchema instead and Schema to schema conversion is not supported. Please use function FlattenDTDOrSchema instead.</i> |

26.3.2.10.12 ConvertToWSDL20

Method: ConvertToWSDL20 (*sFilePath* as String, *bShowDialogs* as Boolean)

Parameters

sFilePath

This specifies the file name of the converted WSDL. In case the source WSDL includes files which also must be converted, then only the directory part of the given path is used and the file names are generated automatically.

bShowDialogs

Defines whether file/folder selection dialogs are shown.

Description

Converts the WSDL 1.1 document to a WSDL 2.0 file. It will also convert any referenced WSDL files that are referenced from within this document. Note that this functionality is limited to WSDL View only. See [Document.CurrentViewMode](#)¹²⁷⁵ and [SPYViewModes](#)¹⁴³⁴.

Errors

| | |
|------|--|
| 1400 | The document object is no longer valid. |
| 1407 | Invalid parameters have been passed or an empty file name has been specified as output target. |
| 1417 | The document is not opened in WSDL view, maybe it is not an '.wsdl' file. |
| 1421 | Feature is not available in this edition. |
| 1433 | WSDL 1.1 to WSDL 2.0 conversion failed. |

26.3.2.10.13 ConvertXMLToFromJSON

Method: ConvertXMLToFromJSON()

Description

Converts XML files to JSON and JSON files to XML.

Errors

| | |
|------|--------------------------------|
| 1400 | The object is no longer valid. |
| 1412 | Error during conversion. |

26.3.2.10.14 CreateChild

Method: CreateChild (*nKind* as [SPYXMLDataKind](#)¹⁴³⁵) as [XMLData](#)¹³⁷³

Return Value

The method returns the new XMLData object.

Description

To create a new XMLData object use the CreateChild() method.

Errors

| | |
|------|---|
| 1400 | The object is no longer valid. |
| 1404 | Cannot create XMLData object. |
| 1407 | Invalid address for the return parameter was specified. |

26.3.2.10.15 CreateDBStructureFromXMLSchema

Method: CreateDBStructureFromXMLSchema (*pDatabase* as [DatabaseConnection](#)¹²⁵⁴, *pTables* as [ElementList](#)¹³⁰⁴, *bDropTableWithExistingName* as Boolean) as String

Description

CreateDBStructureFromXMLSchema exports the given tables to the specified database. The function returns the SQL statements that were necessary to perform the changes.

See also [GetDBStructureList](#)¹²⁸².

Errors

| | |
|------|-----------------------------|
| 1429 | Database selection missing. |
| 1430 | Document export failed. |
| | |
| | |

26.3.2.10.16 CreateSchemaDiagram

Method: CreateSchemaDiagram (*nKind* as [SPYSchemaDefKind](#)¹⁴³¹, *strName* as String, *strFile* as String)

Return Value

None.

Description

The method creates a diagram of the schema type strName of kind nKind and saves the output file into strFile. Note that this functionality is limited to Schema View only. See [Document.CurrentViewMode](#)¹²⁷⁵ and [SPYViewModes](#)¹⁴³⁴.

Errors

| | |
|------|---|
| 1400 | The object is no longer valid. |
| 1414 | Failed to save diagram. |
| 1415 | Invalid schema definition type specified. |

26.3.2.10.17 CurrentViewMode

Method: CurrentViewMode as [SPYViewModes](#)¹⁴³⁴

Description

The property holds the current view mode of the document. See also [Document.SwitchViewMode](#)¹²⁹².

Errors

| | |
|------|---|
| 1400 | The object is no longer valid. |
| 1407 | Invalid address for the return parameter was specified. |

26.3.2.10.18 DataRoot

Property: DataRoot as [XMLData](#)¹³⁷³ (read-only)

Description

This property provides access to the document's first XMLData object of type *spyXMLDataElement*. This is typically the root element for all document content data. See [XMLSpyDocument.RootElement](#)¹²⁸⁸ to get the root element of the whole document including XML prolog data. If the [CurrentViewMode](#)¹²⁷⁵ is not *spyViewGrid* or *spyViewAuthentic* an [UpdateXMLData](#)¹²⁹⁴ may be necessary to get access to the latest [XMLData](#)¹³⁷³.

Errors

| | |
|------|---|
| 1400 | The document object is no longer valid. |
| 1407 | Invalid address for the return parameter was specified. |

26.3.2.10.19 DocEditView

Method: DocEditView as DocEditView

Description

Holds a reference to the current Authentic View object.

Errors

| | |
|------|---|
| 1400 | The object is no longer valid. |
| 1407 | Invalid address for the return parameter was specified. |
| 1417 | Document needs to be open in authentic view mode. |

26.3.2.10.20 Encoding

Property: Encoding as String

Description

This property provides access to the document's encoding value. However, this property can only be accessed when the document is opened in *spyViewGrid*, *spyViewText* or *spyViewAuthentic*. See [CurrentViewMode](#)¹²⁷⁵ on how to detect a document's actual view mode.

This property makes the method [SetEncoding](#)¹²⁹⁰ obsolete.

Possible values are, for example:

8859-1,
8859-2,
ASCII, ISO-646,
850,
1252,
1255,
SHIFT-JIS, MS-KANJI,
BIG5, FIVE,
UTF-7,
UTF-8,
UTF-16

Errors

| | |
|------|---|
| 1400 | The document object is no longer valid. |
| 1407 | Invalid address for the return parameter was specified. |
| 1416 | Operation not supported in current view mode. |

26.3.2.10.21 EndChanges

Method: EndChanges()

Description

Use the method EndChanges to display all changes since the call to [Document.StartChanges](#)¹²⁹¹.

Errors

| | |
|------|--------------------------------|
| 1400 | The object is no longer valid. |
|------|--------------------------------|

26.3.2.10.22 ExecuteXQuery

Method: ExecuteXQuery (*strXMLFileName* as String)

Description

Execute the XQuery statements contained in the document of the document object. Either an XQuery execution or an XQuery Update is performed depending on the file extension of the document. Use the XML file specified in the argument as the XML target document that the XQuery document processes.

- If the document has an XQuery file extension as defined in the Options dialog of XMLSpy, then an XQuery execution is performed. By default: `.xq`, `.xql`, and `.xquery` are set as XQuery file extensions in XMLSpy.
- If the document has an XQuery Update file extension as defined in the Options dialog of XMLSpy, then an XQuery Update action is performed. By default: `.xqu` is set as an XQuery Update file extension in XMLSpy.

If your XQuery script does not use an XML source, set the parameter `strXMLFileName` to an empty string.

Errors

| | |
|------|--|
| 1400 | The document object is no longer valid. |
| 1423 | XQuery transformation error. |
| 1424 | Not all files required for operation could be loaded. Most likely, the file specified in <code>strXMLFileName</code> does not exist or is not valid. |

26.3.2.10.23 ExportToDatabase

Method: ExportToDatabase (*pFromChild* as [XMLData](#)¹³⁷³, *pExportSettings* as [ExportSettings](#)¹³⁰⁶, *pDatabase* as [DatabaseConnection](#)¹²⁵⁴)

Description

ExportToDatabase exports the XML document starting with the element *pFromChild*. The parameter *pExportSettings* defines the behaviour of the export (see [Application.GetExportSettings](#)¹¹⁸¹). The parameter *pDatabase* specifies the destination of the export (see [Application.GetDatabaseSettings](#)¹¹⁷⁹). [UpdateXMLData\(\)](#)¹²⁹⁴ might be indirectly needed as you have to pass the [XMLData](#)¹³⁷³ as parameter to this function.

Errors

| | |
|------|--|
| 1400 | The object is no longer valid. |
| 1407 | Invalid parameter or invalid address for the return parameter was specified. |
| 1416 | Error during export. |
| 1429 | Database selection missing. |
| 1430 | Document export failed. |

Example

```
Dim objDoc As Document
Set objDoc = objSpy.ActiveDocument

'set the behaviour of the export with ExportSettings
Dim objExpSettings As ExportSettings
Set objExpSettings = objSpy.GetExportSettings

'set the destination with DatabaseConnection
```

```

Dim objDB As DatabaseConnection
Set objDB = objSpy.GetDatabaseSettings

objDB.CreateMissingTables = True
objDB.CreateNew = True
objDB.File = "C:\Export.mdb"

objDoc.ExportToDatabase objDoc.RootElement, objExpSettings, objDB
If Err.Number <> 0 Then
    a = MsgBox("Error: " & (Err.Number - vbObjectError) & Chr(13) &
        "Description: " & Err.Description)
End If

```

26.3.2.10.24 ExportToText

Method: ExportToText (pFromChild as [XMLData](#)¹³⁷³, pExportSettings as [ExportSettings](#)¹³⁰⁶, pTextSettings as [TextImportExportSettings](#)¹³⁶⁵)

Description

ExportToText exports tabular information from the document starting at pFromChild into one or many text files. Columns of the resulting tables are generated in alphabetical order of the column header names. Use [GetExportElementList](#)¹²⁸³ to learn about the data that will be exported. The parameter pExportSettings defines the specifics for the export. Set the property [ExportSettings.ElementList](#)¹³⁰⁶ to the - possibly modified - list returned by [GetExportElementList](#)¹²⁸³ to avoid exporting all contained tables. The parameter pTextSettings defines the options specific to text export and import. You need to set the property [TextImportExportSettings.DestinationFolder](#)¹³⁶⁵ before you call ExportToText. [UpdateXMLData\(\)](#)¹²⁹⁴ might be indirectly needed as you have to pass the [XMLData](#)¹³⁷³ as parameter to this function.

See also [import and export of data](#)¹¹⁴².

Errors

| | |
|------|--|
| 1400 | The object is no longer valid. |
| 1407 | Invalid parameter or invalid address for the return parameter was specified. |
| 1416 | Error during export. |
| 1430 | Document export failed. |

Example

```

'-----
' VBA client code fragment - export document to text files
'-----

Dim objDoc As Document
Set objDoc = objSpy.ActiveDocument

Dim objExpSettings As ExportSettings
Set objExpSettings = objSpy.GetExportSettings
objExpSettings.ElementList = objDoc.GetExportElementList(
    objDoc.RootElement,
    objExpSettings)

```

```

Dim objTextExp As TextImportExportSettings
Set objTextExp = objSpy.GetTextImportExportSettings
objTextExp.HeaderRow = True
objTextExp.DestinationFolder = "C:\Exports"

On Error Resume Next
objDoc.ExportToText objDoc.RootElement, objExpSettings, objTextExp

If Err.Number <> 0 Then
    a = MsgBox("Error: " & (Err.Number - vbObjectError) & Chr(13) & "Description: "
    & Err.Description)
End If
    
```

26.3.2.10.25 FlattenDTDOrSchema

Method: FlattenDTDOrSchema (sOutputPath as String, nOutputPathDialogAction as [SPYDialogAction](#)¹⁴²⁵)

Parameters

sOutputPath

The file path for the newly generated file.

nOutputPathDialogAction

Defines the dialog interaction for this call.

Description

FlattenDTDOrSchema takes an existing DTD or schema, generates a flattened file, and saves the generated file at the specified location. In the case of DTDs, flattening removes parameter entities and produces a single DTD from a collection of modules; sections marked IGNORE are suppressed and unused parameter entities are deleted. When an XML Schema is flattened, (i) the components of all included schemas are added as global components of the active schema, and (ii) included schemas are deleted.

Errors

| | |
|------|--------------------------------|
| 1400 | The object is no longer valid. |
| 1412 | Error during conversion. |

26.3.2.10.26 FullName

Property: FullName as String

Description

This property can be used to get or set the full file name - including the path - to where the document gets saved. The validity of the name is not verified before the next save operation.

This property makes the methods [GetPathName](#)¹²⁸³ and [SetPathName](#)¹²⁹¹ obsolete.

Errors

| | |
|------|--|
| 1400 | The document object is no longer valid. |
| 1402 | Empty string has been specified as full file name. |

26.3.2.10.27 GenerateDTDOrSchema

Method: `GenerateDTDOrSchema` (*nFormat* as [SPYDTDSchemaFormat](#)¹⁴²⁶, *nValuesList* as integer, *nDetection* as [SPYTypeDetection](#)¹⁴³³, *nFrequentElements* as [SPYFrequentElements](#)¹⁴²⁶)

Parameters

nFormat

Sets the schema output format to DTD, or W3C.

nValuesList

Generate not more than this amount of enumeration-facets per type. Set to -1 for unlimited.

nDetection

Specifies granularity of simple type detection.

nFrequentElements

Shall the types for all elements be defined as global? Use the value *spyGlobalComplexType* to define them on global scope. Otherwise, use the value *spyGlobalElements*.

Description

Use this method to automatically generate a DTD or schema for the current XML document.

For a finer tuning of DTD / schema generation, use [GenerateDTDOrSchemaEx](#)¹²⁸⁰.

Note that this functionality is not available in ZIP View only. See [Document.CurrentViewMode](#)¹²⁷⁵ and [SPYViewModes](#)¹⁴³⁴.

Errors

| | |
|------|--|
| 1400 | The object is no longer valid. |
| 1407 | Invalid parameter or invalid address for the return parameter was specified. |

26.3.2.10.28 GenerateDTDOrSchemaEx

Method: `GenerateDTDOrSchemaEx` (*objDlg* as [DTDSchemaGeneratorDlg](#)¹²⁹⁹) as [Document](#)¹²⁶⁴

Description

Use this method to automatically generate a DTD or schema for the current XML document. A

[DTDSchemaGeneratorDlg](#)¹²⁹⁹ object is used to pass information to the schema/DTD generator. The generation process can be configured to allow user interaction or run without further user input.

Note that this functionality is not available in ZIP View only. See [Document.CurrentViewMode](#)¹²⁷⁵ and [SPYViewModes](#)¹⁴³⁴.

Errors

| | |
|------|--|
| 1400 | The object is no longer valid. |
| 1407 | Invalid parameter or invalid address for the return parameter was specified. |

26.3.2.10.29 GenerateJSONSchemaDocumentation

Method: GenerateJSONSchemaDocumentation (*objDlg* as [JSONSchemaDocumentationDlg](#)¹³³¹)

Description

Generate documentation for a JSON Schema file in HTML, MS-Word, or RTF format. The parameter *objDlg* is used to parameterize the generation process. Use [Dialogs.JSONSchemaDocumentationDlg](#)¹²⁶² to get an initialized set of options. As a minimum, you will need to set the property [JSONSchemaDocumentationDlg.OutputFile](#)¹³³⁸ before starting the generation process. Note that this functionality is limited to Schema View only. See [Document.CurrentViewMode](#)¹²⁷⁵ and [SPYViewModes](#)¹⁴³⁴.

Errors

| | |
|------|--|
| 1400 | The document object is no longer valid. |
| 1407 | Invalid parameters have been passed or an empty file name has been specified as output target. |
| 1417 | The document is not opened in schema view, maybe it is not a '.json' file. |
| 1421 | Feature is not available in this edition. |
| 1422 | Error during generation |

26.3.2.10.30 GenerateProgramCode

Method: GenerateProgramCode (*objDlg* as [CodeGeneratorDlg](#)¹²⁴⁸)

Only available/enabled in the Enterprise edition. An error is returned, if accessed by any other version.

Description

Generate Java, C++ or C# class files from the XML Schema definitions in your document. A [CodeGeneratorDlg](#)¹²⁴⁸ object is used to pass information to the code generator. The generation process can be configured to allow user interaction or run without further user input.

Errors

| | |
|------|---|
| 1400 | The document object is no longer valid. |
| 1407 | An empty file name has been specified. |
| 1421 | Feature not available in this edition |

26.3.2.10.31 GenerateSampleXML

Method: GenerateSampleXML (*objDlg* as [GenerateSampleXMLDlg](#)¹³²²) as [Document](#)¹²⁶⁴

Description

Generates a sample XML if the document is a schema or DTD. Use [Dialogs.GenerateSampleXMLDlg](#)¹²⁶³ to get an initialized set of options.

Available with TypeLibrary version 1.5

Errors

| | |
|------|---|
| 1400 | The document object is no longer valid. |
|------|---|

26.3.2.10.32 GenerateSchemaDocumentation

Method: GenerateSchemaDocumentation (*objDlg* as [SchemaDocumentationDlg](#)¹³⁴⁵)

Description

Generate documentation for a schema definition file in HTML, MS-Word, or RTF format. The parameter *objDlg* is used to parameterize the generation process. Use [Dialogs.SchemaDocumentationDlg](#)¹²⁶³ to get an initialized set of options. As a minimum, you will need to set the property [SchemaDocumentationDlg.OutputFile](#)¹³⁵² before starting the generation process. Note that this functionality is limited to Schema View only. See [Document.CurrentViewMode](#)¹²⁷⁵ and [SPYViewModes](#)¹⁴³⁴.

Errors

| | |
|------|--|
| 1400 | The document object is no longer valid. |
| 1407 | Invalid parameters have been passed or an empty file name has been specified as output target. |
| 1417 | The document is not opened in schema view, maybe it is not an '.xsd' file. |
| 1421 | Feature is not available in this edition. |
| 1422 | Error during generation |

26.3.2.10.33 GetDBStructureList

Method: GetDBStructureList (*pDatabase* as [DatabaseConnection](#)¹²⁵⁴) as [ElementList](#)¹³⁰⁴

Description

GetDBStructureList creates a collection of elements from the Schema document for which tables in the specified database are created. The function returns a collection of [ElementListItem](#)s where the properties [ElementListItem.Name](#)¹³⁰⁵ contain the names of the tables.

See also [CreateDBStructureFromXMLSchema](#)¹²⁷⁴.

Errors

| | |
|------|---|
| 1400 | The object is no longer valid. |
| 1427 | Failed creating parser for the specified XML. |
| 1428 | Export of element list failed. |
| 1429 | Database selection missing. |

26.3.2.10.34 GetExportElementList

Method: GetExportElementList (*pFromChild* as [XMLData](#)¹³⁷³, *pExportSettings* as [ExportSettings](#)¹³⁰⁶) as [ElementList](#)¹³⁰⁴

Description

GetExportElementList creates a collection of elements to export from the document, depending on the settings in *pExportSettings* and starting from the element *pFromChild*. The function returns a collection of [ElementListItem](#)s where the properties [ElementListItem.Name](#)¹³⁰⁵ contain the names of the tables that can be exported from the document. The property [ElementListItem.FieldCount](#)¹³⁰⁵ contains the number of columns in the table. The property [ElementListItem.RecordCount](#)¹³⁰⁵ contains the number of records in the table. The property [ElementListItem.ElementKind](#)¹³⁰⁵ is unused. [UpdateXMLData\(\)](#)¹²⁹⁴ might be indirectly needed as you have to pass the [XMLData](#)¹³⁷³ as parameter to this function.

See also [Import and export of data](#)¹¹⁴².

Errors

| | |
|------|--|
| 1400 | The object is no longer valid. |
| 1407 | Invalid parameter or invalid address for the return parameter was specified. |
| 1427 | Failed creating parser for the specified XML. |
| 1428 | Export of element list failed. |

26.3.2.10.35 GetPathName (obsolete)

Superseded by [Document.FullName](#)¹²⁷⁹

```
// ---- javascript sample ----
// instead of:
// strPathName = Application.ActiveDocument.GetPathName();
// use now:
strPathName = Application.ActiveDocument.FullName;
```

Method: GetPathName() as String

Description

The method GetPathName gets the path of the active document.

See also [Document.SetPathName](#)¹²⁹¹ (obsolete).

26.3.2.10.36 GridView

Property: GridView as [GridView](#)¹³²⁸

Description

This property provides access to the grid view functionality of the document.

Errors

| | |
|------|---|
| 1400 | The object is no longer valid. |
| 1407 | Invalid address for the return parameter was specified. |
| 1417 | Document needs to be open in enhanced grid view mode. |

26.3.2.10.37 IsModified

Property: IsModified as Boolean

Description

True if the document is modified.

Errors

| | |
|------|---|
| 1400 | The object is no longer valid. |
| 1407 | Invalid address for the return parameter was specified. |

26.3.2.10.38 IsValid

Method: HRESULT IsValid([in, out] VARIANT *strError, [in, out] VARIANT *nErrorPos, [in, out] VARIANT *pBadData, [out,retval] VARIANT_BOOL *bValid);

Return Value

True if the document is valid, false if not. To call `IsValid()`, the application GUI must be visible. (If you wish to validate without the GUI being visible, please use [Altova RaptorXML Server](#).)

Description

`IsValid` validates the document against its associated schema or DTD. `strError` gives you the same error message as when you validate the file within the GUI.

Errors

| | |
|------|--|
| 1400 | The object is no longer valid. |
| 1407 | Invalid parameter or invalid address for the return parameter was specified. |
| 1408 | Unable to validate file. |

Example

The following C++ code snippet provides an example of how to use the `IsValid` method.

```
#import "XMLSpy.tlb"

CComPtr< XMLSpyLib::IDocument12> ipDoc = ipXMLSpy->GetActiveDocument();
if ( ipDoc )
{
    // prepare in/out parameters for IsValid call
    CComVariant variantError;
    CComVariant variantErrorPos;
    CComVariant variantBadData;
    // IsValid always shows a dialog with the validation result. This cannot be turned
    off.
    bool bIsValid = ipDoc->IsValid( &variantError, &variantErrorPos, &variantBadData )
    == VARIANT_TRUE;

    if ( !bIsValid )
    {
        // retrieve values from out parameters
        CString strError = (V_VT( &variantError ) == VT_BSTR ?
V_BSTR( &variantError ) : _T( "" ));
        long npos = (V_VT( &variantErrorPos ) == VT_I4 ? V_I4( &variantErrorPos ) : -
1);
        CComQIPtr< XMLSpyLib::IXMLData > ipXMLBadData = (V_VT( &variantBadData ) ==
VT_DISPATCH ? V_DISPATCH( &variantBadData ) : nullptr);

        if ( ipXMLBadData )
            strError += CString( _T("\n\n Node: ") ) + (LPCWSTR)ipXMLBadData-
>GetName();

        if ( !strError.IsEmpty() )
            AfxMessageBox( "Validation failed - " + strError );
    }
}
```

26.3.2.10.39 IsValidEx

Method: `IsValidEx` (*nXSDVersion* as [SPYValidateXSDVersion](#)¹⁴³³, *nErrorLimit* as `int`, *nErrorFormat* as [SPYValidateErrorFormat](#)¹⁴³⁴, out *strError* as `Variant`) as `Boolean`

Return Value

True if the document is valid, false if not.

Description

`IsValidEx` validates the document against its associated schema or DTD.

In parameters:

`nXSDVersion` which is an enumeration value of [SPYValidateXSDVersion](#)¹⁴³³ that selects the XSD version to validate against.

`nErrorLimit` which is an integer. Values must be 1 to 999.

`nErrorFormat` which is an enumeration value of [SPYValidateErrorFormat](#)¹⁴³⁴ that selects the XSD version to validate against.

Out parameter:

`strError` is the error message, and is the same as that received when validating the file within the GUI.

Errors

| | |
|------|--|
| 1400 | The object is no longer valid. |
| 1407 | Invalid parameter or invalid address for the return parameter was specified. |
| 1408 | Unable to validate file. |

Example

The following C++ code snippet provides an example of how to use the `IsValidEx` method.

```
#import "XMLSpy.tlb"

CComPtr< XMLSpyLib::IDocument12> ipDoc = ipXMLSpy->GetActiveDocument();
if ( ipDoc )
{
    CComVariant variantErrorEx;
    bool bIsValidEx = ipDoc->IsValidEx( XMLSpyLib::spyValidateXSDVersion_AutoDetect,
    100, XMLSpyLib::SPYValidateErrorFormat_LongXML, &variantErrorEx ) == VARIANT_TRUE;

    // // retrieve values from out parameters
    CString strErrorEx = (V_VT( &variantErrorEx ) == VT_BSTR ?
V_BSTR( &variantErrorEx ) : _T( "" ));
    if ( !strErrorEx.IsEmpty() )
        AfxMessageBox( "Validation failed - " + strErrorEx );
}
```

26.3.2.10.40 IsWellFormed

Method: `IsWellFormed` (*pData* as XMLData, *bWithChildren* as Boolean, *strError* as Variant, *nErrorPos* as Variant, *pBadXMLData* as Variant) as Boolean

Return Value

True if the document is well formed.

Description

`IsWellFormed` checks the document for well-formedness starting at the element *pData*.

If the document is not well formed, strError contains an error message, nErrorPos the position in the file and pBadXMLData holds a reference to the element which breaks the well-formedness. These out-parameters are defined as VARIANTS to support scripting languages like VBScript.

Errors

| | |
|------|--|
| 1400 | The object is no longer valid. |
| 1407 | Invalid parameter or invalid address for the return parameter was specified. |

Example

See IsValid.

26.3.2.10.41 Name

Property: Name as String (read-only)

Description

Use this property to retrieve the name - not including the path - of the document file. To change the file name for a document use the property [FullName](#)¹²⁷⁹.

Errors

| | |
|------|---|
| 1400 | The document object is no longer valid. |
| 1407 | Invalid address for the return parameter was specified. |

26.3.2.10.42 Parent

Property: Parent as [Documents](#)¹²⁹⁵ (read-only)

Description

Access the parent of the document object.

Errors

| | |
|------|---|
| 1400 | The document object is no longer valid. |
| 1407 | Invalid address for the return parameter was specified. |

Property: Parent as [Application](#)¹¹⁷² (read-only)

26.3.2.10.43 Path

Property: Path as String (read-only)

Description

Use this property to retrieve the path - not including the file name - of the document file. To change the file name and path for a document use the property [FullName](#)¹²⁷⁹.

Errors

| | |
|------|---|
| 1400 | The document object is no longer valid. |
| 1407 | Invalid address for the return parameter was specified. |

26.3.2.10.44 RootElement

Property: RootElement as [XMLData](#)¹³⁷³ (read-only)

Description

The property RootElement provides access to the root element of the XML structure of the document including the XML prolog data. To access the first element of a document's content navigate to the first child of kind *spyXMLDataElement* or use the [Document.DataRoot](#)¹²⁷⁵ property. If the [CurrentViewMode](#)¹²⁷⁵ is not *spyViewGrid* or *spyViewAuthentic* an [UpdateXMLData](#)¹²⁹⁴ may be necessary to get access to the latest [XMLData](#)¹³⁷³.

Errors

| | |
|------|---|
| 1400 | The document object is no longer valid. |
| 1407 | Invalid address for the return parameter was specified. |

26.3.2.10.45 Save

Method: Save()

Description

The method writes any modifications of the document to the associated file. See also [Document.FullName](#)¹²⁷⁹.

Errors

| | |
|------|--|
| 1400 | The document object is no longer valid. |
| 1407 | An empty file name has been specified. |
| 1403 | Error when saving file, probably the file name is invalid. |

26.3.2.10.46 SaveAs

Method: SaveAs (*strFileName* as String)

Description

Save the document to the file specified. If saving was successful, the [FullName](#)¹²⁷⁹ property gets set to the specified file name.

Errors

| | |
|------|--|
| 1400 | The document object is no longer valid. |
| 1407 | An empty file name has been specified. |
| 1403 | Error when saving file, probably the file name is invalid. |

26.3.2.10.47 Saved

Property: Saved as Boolean (read-only)

Description

This property can be used to check if the document has been saved after the last modifications. It returns the negation of [IsModified](#)¹²⁸⁴.

Errors

| | |
|------|---|
| 1400 | The document object is no longer valid. |
| 1407 | Invalid address for the return parameter was specified. |

26.3.2.10.48 SaveInString

Method: SaveInString (pData as [XMLData](#)¹³⁷³, bMarked as Boolean) as String

Parameters

pData

XMLData element to start. Set pData to [Document.RootElement](#)¹²⁸⁸ if you want to copy the complete file.

bMarked

If bMarked is true, only the elements selected in the grid view are copied.

Return Value

Returns a string with the XML data.

Description

SaveInString starts at the element pData and converts the XMLData objects to a string representation.

[UpdateXMLData\(\)](#)¹²⁹⁴ might be indirectly needed as you have to pass the [XMLData](#)¹³⁷³ as parameter to this function.

Errors

| | |
|------|--|
| 1400 | The object is no longer valid. |
| 1407 | Invalid parameter or invalid address for the return parameter was specified. |

26.3.2.10.49 SaveToURL

Method: SaveToURL (strURL as String, strUser as String, strPassword as String)

Return Value

Description

SaveToURL() writes the document to the URL strURL. This method does not set the permanent file path of the document.

Errors

| | |
|------|--------------------------------|
| 1400 | The object is no longer valid. |
| 1402 | Invalid URL specified. |
| 1403 | Error while saving to URL. |

26.3.2.10.50 Selection

Property: Selection(string)

Description

Sets the current selection in the document.

Errors

| | |
|------|--------------------------------|
| 1400 | The object is no longer valid. |
|------|--------------------------------|

26.3.2.10.51 SetActiveDocument

Method: SetActiveDocument()

Description

The method sets the document as the active and brings it to the front.

Errors

| | |
|------|--------------------------------|
| 1400 | The object is no longer valid. |
|------|--------------------------------|

26.3.2.10.52 SetEncoding (obsolete)

Superseded by [Document.Encoding](#) ¹²⁷⁵

```
// ---- javascript sample ----
// instead of:
// Application.ActiveDocument.SetEncoding("UTF-16");
// use now:
Application.ActiveDocument.Encoding = "UTF-16";
```

Method: SetEncoding (*strEncoding* as String)

Description

SetEncoding sets the encoding of the document like the menu item "File/Encoding..." in XMLSpy. Possible values for *strEncoding* are, for example:

```
8859-1,
8859-2,
ASCII, ISO-646,
850,
1252,
1255,
```

SHIFT-JIS, MS-KANJI,
BIG5, FIVE,
UTF-7,
UTF-8,
UTF-16

26.3.2.10.53 SetExternallsValid

Method: SetExternallsValid (*bValid* as Boolean)

Parameters

bValid
Sets the result of an external validation process.

Description

The internal information set by this method is only queried on cancelling the default validation in any [OnBeforeValidate](#)¹²⁶⁷ handler.

Available with TypeLibrary version 1.5

Errors

| | |
|------|--------------------------------|
| 1400 | The object is no longer valid. |
|------|--------------------------------|

26.3.2.10.54 SetPathName (obsolete)

Superseded by [Document.FullName](#)¹²⁷⁹

```
// ---- javascript sample ----
// instead of:
// Application.ActiveDocument.SetPathName("C:\\myXMLFiles\\test.xml");
// use now:
Application.ActiveDocument.FullName = "C:\\myXMLFiles\\test.xml";
```

Method: SetPathName (*strPath* as String)

Description

The method SetPathName sets the path of the active document. SetPathName only copies the string and does not check if the path is valid. All succeeding save operations are done into this file.

26.3.2.10.55 StartChanges

Method: StartChanges()

Description

After StartChanges is executed XMLSpy will not update its editor windows until [Document.EndChanges](#)¹²⁷⁶ is called. This increases performance of complex tasks to the XML structure.

Errors

| | |
|------|--------------------------------|
| 1400 | The object is no longer valid. |
|------|--------------------------------|

26.3.2.10.56 Suggestions

Property: Suggestions as Array

Description

This property contains the last valid user suggestions for this document. The XMLSpy generated suggestions can be modified before they are shown to the user in the [OnBeforeShowSuggestions](#)¹³⁶⁸ event.

Errors

| | |
|------|--|
| 1400 | The object is no longer valid. |
| 1407 | Invalid parameter or invalid address for the return parameter was specified. |

26.3.2.10.57 SwitchViewMode

Method: SwitchViewMode (*nMode* as [SPYViewModes](#)¹⁴³⁴) as Boolean

Return value

Returns true if view mode is switched.

Description

The method sets the current view mode of the document in XMLSpy. See also [Document.CurrentViewMode](#)¹²⁷⁵.

Errors

| | |
|------|---|
| 1400 | The object is no longer valid. |
| 1407 | Invalid address for the return parameter was specified. |
| 1417 | Invalid view mode specified. |

26.3.2.10.58 TextView

Property: TextView as [TextView](#)¹³⁶⁷

Description

This property provides access to the text view functionality of the document.

Errors

| | |
|------|---|
| 1400 | The object is no longer valid. |
| 1407 | Invalid address for the return parameter was specified. |

26.3.2.10.59 Title

Property: Title as String (read-only)

Description

Title contains the file name of the document. To get the path and filename of the file use [FullName](#)¹²⁷⁹.

Errors

| | |
|------|---|
| 1400 | The document object is no longer valid. |
| 1407 | Invalid address for the return parameter was specified. |

26.3.2.10.60 TransformXSL

Method: TransformXSL()

Description

TransformXSL processes the XML document via the associated XSL file. See [Document.AssignXSL](#)¹²⁶⁹ on how to place a reference to a XSL file into the document.

Errors

| | |
|------|---|
| 1400 | The document object is no longer valid. |
| 1411 | Error during transformation process. |

26.3.2.10.61 TransformXSLEx

Method: TransformXSLEx(*nAction* as [SPYDialogAction](#)¹⁴²⁵)

Description

TransformXSLEx processes the XML document via the associated XSL file. The parameter specifies whether a dialog asking for the result document name should pop up or not. See [Document.AssignXSL](#)¹²⁶⁹ on how to place a reference to a XSL file into the document.

Errors

| | |
|------|---|
| 1400 | The document object is no longer valid. |
| 1411 | Error during transformation process. |

26.3.2.10.62 TransformXSLFO

Method: TransformXSLFO()

Description

TransformXSLFO processes the XML document via the associated XSLFO file. See [AssignXSLFO](#)¹²⁷⁰ on how to place a reference to a XSLFO file into the document. You need to assign a FOP processor to XMLSpy before you can use this method.

Errors

| | |
|------|---|
| 1400 | The document object is no longer valid. |
| 1411 | Error during transformation process. |

26.3.2.10.63 TransformXSLFOEx

Method: TransformXSLFOEx(*nAction* as [SPYDialogAction](#)¹⁴²⁵, *string* as sOutputFilepath)¹⁴²⁵

Description

TransformXSLFOEx performs an XSL-FO transformation. It processes the XML document via the associated XSL-FO file. The parameter specifies whether a dialog asking for the result document name should pop up or not. See [Document.AssignXSLFO](#)¹²⁷⁰ on how to place a reference to an XSL-FO file into the document.

Errors

| | |
|------|---|
| 1400 | The document object is no longer valid. |
| 1411 | Error during transformation process. |

26.3.2.10.64 UpdateViews

Method: UpdateViews()

Description

To redraw the Enhanced Grid View and the Tree View call UpdateViews. This can be important after you changed the XMLData structure of a document. This method does not redraw the text view of XMLSpy.

Errors

| | |
|------|---|
| 1400 | The document object is no longer valid. |
|------|---|

26.3.2.10.65 UpdateXMLData

Method: UpdateXMLData() as Boolean

Description

The [XMLData](#)¹³⁷³ tree is updated from the current view. Please note that this can fail in case of the TextView if the current XML text is not well-formed. This is not necessary if [CurrentViewMode](#)¹²⁷⁵ is *spyViewGrid* or *spyViewAuthentic* because these views keep the [XMLData](#)¹³⁷³ updated.

Available with TypeLibrary version 1.5

Errors

| | |
|------|---|
| 1400 | The document object is no longer valid. |
|------|---|

26.3.2.10.66 ValidateOnServer

Method: ValidateOnServer(nErrorFormat as [SPYValidateErrorFormat](#)¹⁴³⁴) as Boolean

Description

Validates the document on the server using the currently active RaptorXMLServer.

Errors

| | |
|------|---|
| 1400 | The document object is no longer valid. |
|------|---|

26.3.2.11 Documents

Properties

- [Count](#)¹²⁹⁶
- [Item](#)¹²⁹⁶

Methods

- [NewAuthenticFile](#)¹²⁹⁶
- [NewFile](#)¹²⁹⁷
- [NewFileFromText](#)¹²⁹⁷
- [OpenAuthenticFile](#)¹²⁹⁷
- [OpenFile](#)¹²⁹⁸
- [OpenURL](#)¹²⁹⁸
- [OpenURLDialog](#)¹²⁹⁹

Description

This object represents the set of documents currently open in XMLSpy. Use this object to open further documents or iterate through already opened documents.

Examples

```
' -----
' XMLSpy scripting environment - VBScript
' iterate through open documents
' -----

Dim objDocuments
Set objDocuments = Application.Documents

For Each objDoc In objDocuments
    'do something useful with your document
    objDoc.SetActiveDocument()
Next

// -----
// XMLSpy scripting environment - JScript
// close all open documents
// -----
```

```

for (var iter = new Enumerator (Application.Documents);
    ! iter.atEnd();
    iter.moveNext())
{
    // MsgBox ("Closing file " + iter.item().Name);
    iter.item().Close (true);
}

```

26.3.2.11.1 Count

Property: Count as long

Description

Count of open documents.

Errors

| | |
|------|--------------------------|
| 1600 | Invalid Documents object |
| 1601 | Invalid input parameter |

26.3.2.11.2 Item

Method: Item (*n* as long) as [Document](#)¹²⁶⁴

Description

Gets the document with the index *n* in this collection. Index is 1-based.

Errors

| | |
|------|--------------------------|
| 1600 | Invalid Documents object |
| 1601 | Invalid input parameter |

26.3.2.11.3 NewAuthenticFile

Method: NewAuthenticFile (*strSPSPath* as String, *strXMLPath* as String) as [Document](#)¹²⁶⁴

Parameters

strSPSPath

The path to the SPS document.

strXMLPath

The new XML document name.

Return Value

The method returns the new document.

Description

NewAuthenticFile creates a new XML file and opens it in Authentic View using SPS design strSPSPath.

26.3.2.11.4 NewFile

Method: NewFile (*strFile* as String, *strType* as String) as [Document](#)¹²⁶⁴

Parameters

strFile

Full path of new file.

strType

Type of new file as string (i.e. "xml", "xsd", ...)

Return Value

Returns the new file.

Description

NewFile creates a new file of type strType (i.e. "xml"). The newly created file is also the ActiveDocument.

26.3.2.11.5 NewFileFromText

Method: NewFileFromText (*strText* as String, *strType* as String) as [Document](#)¹²⁶⁴

Parameters

strText

The content of the new document in plain text.

strType

Type of the document to create (i.e. "xml").

Return Value

The method returns the new document.

Description

NewFileFromText creates a new document with strText as its content.

26.3.2.11.6 OpenAuthenticFile

Method: OpenAuthenticFile (*strSPSPath* as String, *strXMLPath* as String) as [Document](#)¹²⁶⁴

Parameters

strSPSPath

The path to the SPS document.

strXMLPath

The path to the XML document (can be empty).

Return Value

The method returns the new document.

Description

OpenAuthenticFile opens an XML file or database in Authentic View using SPS design strSPSPath.

26.3.2.11.7 OpenFile

Method: OpenFile (*strPath* as String, *bDialog* as Boolean) as [Document](#)¹²⁶⁴

Parameters

strPath

Path and file name of file to open.

bDialog

Show dialogs for user input.

Return Value

Returns the opened file on success.

Description

OpenFile opens the file strPath. If bDialog is TRUE, a file-dialog will be displayed.

Example

```
Dim objDoc As Document
Set objDoc = objSpy.Documents.OpenFile(strFile, False)
```

26.3.2.11.8 OpenURL

Method: OpenURL (*strURL* as String, *nURLType* as [SPYURLTypes](#)¹⁴³³, *nLoading* as [SPYLoading](#)¹⁴²⁸, *strUser* as String, *strPassword* as String) as [Document](#)¹²⁶⁴

Parameters

strURL

URL to open as document.

nURLType

Type of document to open. Set to -1 for auto detection.

nLoading

Set nLoading to 0 (zero) if you want to load it from cache or proxy. Otherwise set nLoading to 1.

strUser

Name of the user if required. Can be empty.

strPassword

Password for authentication. Can be empty.

Return Value

The method returns the opened document.

Description

OpenURL opens the URL strURL.

26.3.2.11.9 OpenURLDialog

Method: OpenURLDialog (strURL as String, nURLType as [SPYURLTypes](#)¹⁴³³, nLoading as [SPYLoading](#)¹⁴²⁸, strUser as String, strPassword as String) as [Document](#)¹²⁶⁴

Parameters

strURL

URL to open as document.

nURLType

Type of document to open. Set to -1 for auto detection.

nLoading

Set nLoading to 0 (zero) if you want to load it from cache or proxy. Otherwise set nLoading to 1.

strUser

Name of the user if required. Can be empty.

strPassword

Password for authentication. Can be empty.

Return Value

The method returns the opened document.

Description

OpenURLDialog displays the "open URL" dialog to the user and presets the input fields with the given parameters.

26.3.2.12 DTDSchemaGeneratorDlg

Properties and Methods

Standard automation properties

[Application](#)¹³⁰⁰

[Parent](#)¹³⁰³

[DTDSchemaFormat](#)¹³⁰⁰

[ValueList](#)¹³⁰³

[TypeDetection](#)¹³⁰³

[FrequentElements](#)¹³⁰¹

[MergeAllEqualNamed](#)¹³⁰¹

[ResolveEntities](#)¹³⁰³

[AttributeTypeDefinition](#)¹³⁰⁰

[GlobalAttributes](#)¹³⁰¹

[OnlyStringEnums](#)¹³⁰²[MaxEnumLength](#)¹³⁰¹[OutputPath](#)¹³⁰²[OutputPathDialogAction](#)¹³⁰²**Description**

Use this object to configure the generation of a schema or DTD. The method [GenerateDTDOrSchemaEx](#)¹²⁸⁰ expects a DTDSchemaGeneratorDlg as parameter to configure the generation as well as the associated user interactions.

26.3.2.12.1 Application

Property: Application as [Application](#)¹¹⁷² (read-only)

Description

Access the XMLSpy application object.

Errors

| | |
|------|---|
| 3000 | The object is no longer valid. |
| 3001 | Invalid address for the return parameter was specified. |

26.3.2.12.2 AttributeTypeDefinition

Property: AttributeTypeDefinition as [SPYAttributeTypeDefinition](#)¹⁴²³

Description

Specifies how attribute definitions get merged.

Errors

| | |
|------|---|
| 3000 | The object is no longer valid. |
| 3001 | Invalid address for the return parameter was specified. |

26.3.2.12.3 DTDSchemaFormat

Property: DTDSchemaFormat as [SPYDTDSchemaFormat](#)¹⁴²⁶

Description

Sets the schema output format to DTD, or W3C.

Errors

| | |
|------|---|
| 3000 | The object is no longer valid. |
| 3001 | Invalid address for the return parameter was specified. |

26.3.2.12.4 FrequentElements

Property: FrequentElements as [SPYFrequentElements](#)¹⁴²⁶

Description

Shall the types for all elements be defined as global? Use the value *spyGlobalComplexType* to define them on global scope. Otherwise, use the value *spyGlobalElements*.

Errors

| | |
|------|---|
| 3000 | The object is no longer valid. |
| 3001 | Invalid address for the return parameter was specified. |

26.3.2.12.5 GlobalAttributes

Property: GlobalAttributes as Boolean

Description

Shall attributes with same name and type be resolved globally?

Errors

| | |
|------|---|
| 3000 | The object is no longer valid. |
| 3001 | Invalid address for the return parameter was specified. |

26.3.2.12.6 MaxEnumLength

Property: MaxEnumLength as Integer

Description

Specifies the maximum number of characters allowed for enumeration names. If one value is longer than this, no enumeration will be generated.

Errors

| | |
|------|---|
| 3000 | The object is no longer valid. |
| 3001 | Invalid address for the return parameter was specified. |

26.3.2.12.7 MergeAllEqualNamed

Property: MergeAllEqualNamed as Boolean

Description

Shall types of all elements with the same name be merged into one type?

Errors

| | |
|------|---|
| 3000 | The object is no longer valid. |
| 3001 | Invalid address for the return parameter was specified. |

26.3.2.12.8 OnlyStringEnums

Property: OnlyStringEnums as Boolean

Description

Specifies if enumerations will be created only for plain strings or all types of values.

Errors

| | |
|------|---|
| 3000 | The object is no longer valid. |
| 3001 | Invalid address for the return parameter was specified. |

26.3.2.12.9 OutputPath

Property: OutputPath as String

Description

Selects the file name for the generated schema/DTD.

Errors

| | |
|------|---|
| 3000 | The object is no longer valid. |
| 3001 | Invalid address for the return parameter was specified. |

26.3.2.12.10 OutputPathDialogAction

Property: OutputPathDialogAction as [SPYDialogAction](#)¹⁴²⁵

Description

Defines how the sub-dialog for selecting the schema/DTD output path gets handled. Set this value to *spyDialogUserInput(2)* to show the dialog with the current value of the [OutputPath](#)¹³⁰² property as default. Use *spyDialogOK(0)* to hide the dialog from the user.

Errors

| | |
|------|---|
| 3000 | The object is no longer valid. |
| 3001 | Invalid address for the return parameter was specified. |

26.3.2.12.11 Parent

Property: Parent as [Dialogs](#)¹²⁶¹ (read-only)

Description

Access the parent of the object.

Errors

| | |
|------|---|
| 3000 | The object is no longer valid. |
| 3001 | Invalid address for the return parameter was specified. |

26.3.2.12.12 ResolveEntities

Property: ResolveEntities as Boolean

Description

Shall all entities be resolved before generation starts? If yes, an info-set will be built.

Errors

| | |
|------|---|
| 3000 | The object is no longer valid. |
| 3001 | Invalid address for the return parameter was specified. |

26.3.2.12.13 TypeDetection

Property: TypeDetection as [SPYTypeDetection](#)¹⁴³³

Description

Specifies granularity of simple type detection.

Errors

| | |
|------|---|
| 3000 | The object is no longer valid. |
| 3001 | Invalid address for the return parameter was specified. |

26.3.2.12.14 ValueList

Property: ValueList as Integer

Description

Generate not more than this amount of enumeration-facets per type. Set to -1 for unlimited.

Errors

| | |
|------|--------------------------------|
| 3000 | The object is no longer valid. |
|------|--------------------------------|

| | |
|------|---|
| 3001 | Invalid address for the return parameter was specified. |
|------|---|

26.3.2.13 ElementList

Properties

[Count](#)¹³⁰⁴

[Item](#)¹³⁰⁴

Methods

[RemoveElement](#)¹³⁰⁴

Description

Element lists are used for different purposes during export and import of data. Depending on this purpose, different properties of [ElementListItem](#)¹³⁰⁵ are used.

It can hold

- a list of table names returned by a call to [Application.GetDatabaseTables](#)¹¹⁸⁰,
- a list of field names returned by a call to [Application.GetDatabaseImportElementList](#)¹¹⁷⁹ or [Application.GetTextImportElementList](#)¹¹⁸¹,
- a field name filter list used in [Application.ImportFromDatabase](#)¹¹⁸³ and [Application.ImportFromText](#)¹¹⁸⁵,
- a list of table names and counts for their rows and columns as returned by calls to [GetExportElementList](#)¹²⁸³ or
- a field name filter list used in [Document.ExportToDatabase](#)¹²⁷⁷ and [Document.ExportToText](#)¹²⁷⁸.

26.3.2.13.1 Count

Property: Count as long (read-only)

Description

Count of elements in this collection.

26.3.2.13.2 Item

Method: Item(n as long) as [ElementListItem](#)¹³⁰⁵

Description

Gets the element with the index n from this collection. The first item has index 1.

26.3.2.13.3 RemoveElement

Method: RemoveElement(Index as long)

Description

RemoveElement removes the element Index from the collection. The first Item has index 1.

26.3.2.14 ElementListItem

Properties

[Name](#) ¹³⁰⁵

[ElementKind](#) ¹³⁰⁵

[FieldCount](#) ¹³⁰⁵

[RecordCount](#) ¹³⁰⁵

Description

An element in an [ElementList](#) ¹³⁰⁴. Usage of its properties depends on the purpose of the element list. For details see [ElementList](#) ¹³⁰⁴.

26.3.2.14.1 ElementKind

Property: ElementKind as [SPYXMLDataKind](#) ¹⁴³⁵

Description

Specifies if a field should be imported as XML element (data value of spyXMLDataElement) or attribute (data value of spyXMLDataAttr).

26.3.2.14.2 FieldCount

Property: FieldCount as long (read-only)

Description

Count of fields (i.e. columns) in the table described by this element. This property is only valid after a call to [Document.GetExportElementList](#) ¹²⁸³.

26.3.2.14.3 Name

Property: Name as String (read-only)

Description

Name of the element. This is either the name of a table or a field, depending on the purpose of the element list.

26.3.2.14.4 RecordCount

Property: RecordCount as long (read-only)

Description

Count of records (i.e. rows) in the table described by this element. This property is only valid after a call to [Document.GetExportElementList](#) ¹²⁸³.

26.3.2.15 ExportSettings

Properties

[ElementList](#) ¹³⁰⁶

[EntitiesToText](#) ¹³⁰⁷

[ExportAllElements](#) ¹³⁰⁷

[SubLevelLimit](#) ¹³⁰⁸

[FromAttributes](#) ¹³⁰⁷

[FromSingleSubElements](#) ¹³⁰⁷

[FromTextValues](#) ¹³⁰⁷

[CreateKeys](#) ¹³⁰⁶

[IndependentPrimaryKey](#) ¹³⁰⁸

[Namespace](#) ¹³⁰⁸

[ExportCompleteXML](#) ¹³⁰⁷

[StartFromElement](#) ¹³⁰⁸

Description

ExportSettings contains options used during export of XML data to a database or text file. See [Import and export of data](#) ¹¹⁴² for a general overview.

26.3.2.15.1 CreateKeys

Property: CreateKeys as Boolean

Description

This property turns creation of keys (i.e. primary key and foreign key) on or off. Default is True.

26.3.2.15.2 ElementList

Property: ElementList as [ElementList](#) ¹³⁰⁴

Description

Default is empty list. This list of elements defines which fields will be exported. To get the list of available fields use [Document.GetExportElementList](#) ¹²⁸³. It is possible to prevent exporting columns by removing elements from this list with [ElementList.RemoveElement](#) ¹³⁰⁴ before passing it to [Document.ExportToDatabase](#) ¹²⁷⁷ or [Document.ExportToText](#) ¹²⁷⁸.

26.3.2.15.3 EntitiesToText

Property: EntitiesToText as Boolean

Description

Defines if XML entities should be converted to text or left as they are during export. Default is True.

26.3.2.15.4 ExportAllElements

Property: ExportAllElements as Boolean

Description

If set to true, all elements in the document will be exported. If set to false, then [ExportSettings.SubLevelLimit](#)¹³⁰⁸ is used to restrict the number of sub levels to export. Default is true.

26.3.2.15.5 ExportCompleteXML

Property: ExportCompleteXML as Boolean

Description

Defines whether the complete XML is exported or only the element specified by [StartFromElement](#)¹³⁰⁸ and its children. Default is True.

26.3.2.15.6 FromAttributes

Property: FromAttributes as Boolean

Description

Set FromAttributes to false if no export data should be created from attributes. Default is True.

26.3.2.15.7 FromSingleSubElements

Property: FromSingleSubElements as Boolean

Description

Set FromSingleSubElements to false if no export data should be created from elements. Default is True.

26.3.2.15.8 FromTextValues

Property: FromTextValues as Boolean

Description

Set FromTextValues to false if no export data should be created from text values. Default is True.

26.3.2.15.9 IndependentPrimaryKey

Property: IndependentPrimaryKey as Boolean

Description

Turns creation of independent primary key counter for every element on or off. If [ExportSettings.CreateKeys](#)¹³⁰⁶ is False, this property will be ignored. Default is True.

26.3.2.15.10 Namespace

Property: Namespace as [SPYExportNamespace](#)¹⁴²⁶

Description

The default setting removes all namespace prefixes from the element names. In some database formats the colon is not a legal character. Default is spyNoNamespace.

26.3.2.15.11 StartFromElement

Property: StartFromElement as String

Description

Specifies the start element for the export. This property is only considered when [ExportCompleteXML](#)¹³⁰⁷ is false.

26.3.2.15.12 SubLevelLimit

Property: SubLevelLimit as Integer

Description

Defines the number of sub levels to include for the export. Default is 0. This property is ignored if [ExportSettings.ExportAllElements](#)¹³⁰⁷ is true.

26.3.2.16 FileSelectionDlg

Properties and Methods

Standard automation properties

[Application](#)¹³⁰⁹

[Parent](#)¹³¹⁰

Dialog properties

[FullName](#)¹³⁰⁹

Acceptance or cancellation of action that caused event

[DialogAction](#)¹³⁰⁹

Description

The dialog object allows you to receive information about an event and pass back information to the event handler in the same way as with a user dialog. Use the [FileSelectionDlg.FullName](#)¹³⁰⁹ to select or modify the file path and set the [FileSelectionDlg.DialogAction](#)¹³⁰⁹ property to cancel or agree with the action that caused the event.

26.3.2.16.1 Application

Property: Application as [Application](#)¹¹⁷² (read-only)

Description

Access the XMLSpy application object.

Errors

| | |
|------|---|
| 2400 | The object is no longer valid. |
| 2401 | Invalid address for the return parameter was specified. |

26.3.2.16.2 DialogAction

Property: DialogAction as [SPYDialogAction](#)¹⁴²⁵

Description

If you want your script to perform the file selection operation without any user interaction necessary, simulate user interaction by either setting the property to *spyDialogOK(0)* or *spyDialogCancel(1)*.

To allow your script to fill in the default values but let the user see and react on the dialog, use the value *spyDialogUserInput(2)*. If you receive a FileSelectionDlg object in an event handler, *spyDialogUserInput(2)* is not supported and will be interpreted as *spyDialogOK(0)*.

Errors

| | |
|------|--|
| 2400 | The object is no longer valid. |
| 2401 | Invalid value for dialog action or invalid address for the return parameter was specified. |

26.3.2.16.3 FullName

Property: FullName as String

Description

Access the full path of the file the gets selected by the dialog. Most events that pass a FileSelectionDlg object to you allow you modify this value and thus influence the action that caused the event (e.g. load or save to a different location).

Errors

| | |
|------|---|
| 2400 | The object is no longer valid. |
| 2401 | Invalid address for the return parameter was specified. |

26.3.2.16.4 Parent

Property: Parent as [Dialogs](#)¹²⁶¹ (read-only)

Description

Access the parent of the object.

Errors

| | |
|------|---|
| 2400 | The object is no longer valid. |
| 2401 | Invalid address for the return parameter was specified. |

26.3.2.17 FindInFilesDlg

Properties and Methods

Standard automation properties

[Application](#)¹³¹¹

[Parent](#)¹³¹³

[Find](#)¹³¹²

[RegularExpression](#)¹³¹³

[Replace](#)¹³¹³

[DoReplace](#)¹³¹¹

[ReplaceOnDisk](#)¹³¹³

[MatchWholeWord](#)¹³¹²

[MatchCase](#)¹³¹²

[SearchLocation](#)¹³¹⁴

[StartFolder](#)¹³¹⁵

[IncludeSubfolders](#)¹³¹²

[SearchInProjectFilesDoExternal](#)¹³¹⁴

[FileExtension](#)¹³¹¹

[AdvancedXMLSearch](#)¹³¹¹

[XMLElementNames](#)¹³¹⁶

[XMLElementContents](#)¹³¹⁶

[XMLAttributeNames](#)¹³¹⁵

[XMLAttributeContents](#)¹³¹⁵

[XMLComments](#)¹³¹⁶

[XMLCDATA](#)¹³¹⁵

[XMLPI](#)¹³¹⁶

[XMLRest](#)¹³¹⁷

[ShowResult](#)¹³¹⁴

Description

Use this object to configure the search (or replacement) for strings in files. The method [FindInFiles](#)¹¹⁷⁹ expects a FindInFilesDlg as parameter.

26.3.2.17.1 AdvancedXMLSearch

Property: AdvancedXMLSearch as Boolean

Description

Specifies if the XML search properties ([XMLElementNames](#)¹³¹⁶, [XMLElementContents](#)¹³¹⁶, [XMLAttributeNames](#)¹³¹⁵, [XMLAttributeContents](#)¹³¹⁶, [XMLComments](#)¹³¹⁶, [XMLCDATA](#)¹³¹⁵, [XMLPI](#)¹³¹⁶ and [XMLRest](#)¹³¹⁷) are considered. The default is false.

Errors

| | |
|------|---|
| 3500 | The object is no longer valid. |
| 3501 | Invalid address for the return parameter was specified. |

26.3.2.17.2 Application

Property: Application as [Application](#)¹¹⁷² (read-only)

Description

Access the XMLSpy application object.

Errors

| | |
|------|---|
| 3500 | The object is no longer valid. |
| 3501 | Invalid address for the return parameter was specified. |

26.3.2.17.3 DoReplace

Property: DoReplace as Boolean

Description

Specifies if the matched string is replaced by the string defined in [Replace](#)¹³¹³. The default is false.

Errors

| | |
|------|---|
| 3500 | The object is no longer valid. |
| 3501 | Invalid address for the return parameter was specified. |

26.3.2.17.4 FileExtension

Property: FileExtension as String

Description

Specifies the file filter of the files that should be considered during the search. Multiple file filters must be delimited with a semicolon (eg: *.xml;*.dtd;a*.xsd). Use the wildcards * and ? to define the file filter.

Errors

| | |
|------|---|
| 3500 | The object is no longer valid. |
| 3501 | Invalid address for the return parameter was specified. |

26.3.2.17.5 Find

Property: Find as String

Description

Specifies the string to search for.

Errors

| | |
|------|---|
| 3500 | The object is no longer valid. |
| 3501 | Invalid address for the return parameter was specified. |

26.3.2.17.6 IncludeSubfolders

Property: IncludeSubfolders as Boolean

Description

Specifies if subfolders are searched too. The default is true.

Errors

| | |
|------|---|
| 3500 | The object is no longer valid. |
| 3501 | Invalid address for the return parameter was specified. |

26.3.2.17.7 MatchCase

Property: MatchCase as Boolean

Description

Specifies if the search is case sensitive. The default is true.

Errors

| | |
|------|---|
| 3500 | The object is no longer valid. |
| 3501 | Invalid address for the return parameter was specified. |

26.3.2.17.8 MatchWholeWord

Property: MatchWholeWord as Boolean

Description

Specifies whether the whole word or just a part of it must match. The default is false.

Errors

| | |
|------|---|
| 3500 | The object is no longer valid. |
| 3501 | Invalid address for the return parameter was specified. |

26.3.2.17.9 Parent

Property: Parent as [Dialogs](#)¹²⁶¹ (read-only)

Description

Access the parent of the object.

Errors

| | |
|------|---|
| 3500 | The object is no longer valid. |
| 3501 | Invalid address for the return parameter was specified. |

26.3.2.17.10 RegularExpression

Property: RegularExpression as Boolean

Description

Specifies if [Find](#)¹³¹² contains a regular expression. The default is false.

Errors

| | |
|------|---|
| 3500 | The object is no longer valid. |
| 3501 | Invalid address for the return parameter was specified. |

26.3.2.17.11 Replace

Property: Replace as String

Description

Specifies the replacement string. The matched string is only replaced if [DoReplace](#)¹³¹¹ is set true.

Errors

| | |
|------|---|
| 3500 | The object is no longer valid. |
| 3501 | Invalid address for the return parameter was specified. |

26.3.2.17.12 ReplaceOnDisk

Property: ReplaceOnDisk as Boolean

Description

Specifies if the replacement is done directly on disk. The modified file is not opened. The default is false.

Errors

| | |
|------|---|
| 3500 | The object is no longer valid. |
| 3501 | Invalid address for the return parameter was specified. |

26.3.2.17.13 SearchInProjectFilesDoExternal

Property: SearchInProjectFilesDoExternal as Boolean

Description

Specifies if the external folders in the open project are searched, when a project search is performed. The default is false.

Errors

| | |
|------|---|
| 3500 | The object is no longer valid. |
| 3501 | Invalid address for the return parameter was specified. |

26.3.2.17.14 SearchLocation

Property: SearchLocation as [SPYFindInFilesSearchLocation](#)¹⁴²⁶

Description

Specifies the location of the search. The default is spyFindInFiles_Documents.

Errors

| | |
|------|---|
| 3500 | The object is no longer valid. |
| 3501 | Invalid address for the return parameter was specified. |

26.3.2.17.15 ShowResult

Property: ShowResult as Boolean

Description

Specifies if the result is displayed in the Find in Files output window. The default is false.

Errors

| | |
|------|---|
| 3500 | The object is no longer valid. |
| 3501 | Invalid address for the return parameter was specified. |

26.3.2.17.16 StartFolder

Property: StartFolder as String

Description

Specifies the folder where the disk search starts.

Errors

| | |
|------|---|
| 3500 | The object is no longer valid. |
| 3501 | Invalid address for the return parameter was specified. |

26.3.2.17.17 XMLAttributeContents

Property: XMLAttributeContents as Boolean

Description

Specifies if attribute contents are searched when [AdvancedXMLSearch](#)¹³¹¹ is true. The default is true.

Errors

| | |
|------|---|
| 3500 | The object is no longer valid. |
| 3501 | Invalid address for the return parameter was specified. |

26.3.2.17.18 XMLAttributeNames

Property: XMLAttributeNames as Boolean

Description

Specifies if attribute names are searched when [AdvancedXMLSearch](#)¹³¹¹ is true. The default is true.

Errors

| | |
|------|---|
| 3500 | The object is no longer valid. |
| 3501 | Invalid address for the return parameter was specified. |

26.3.2.17.19 XMLCDATA

Property: XMLCDATA as Boolean

Description

Specifies if CDATA tags are searched when [AdvancedXMLSearch](#)¹³¹¹ is true. The default is true.

Errors

| | |
|------|---|
| 3500 | The object is no longer valid. |
| 3501 | Invalid address for the return parameter was specified. |

26.3.2.17.20 XMLComments

Property: XMLComments as Boolean

Description

Specifies if comments are searched when [AdvancedXMLSearch](#)¹³¹¹ is true. The default is true.

Errors

| | |
|------|---|
| 3500 | The object is no longer valid. |
| 3501 | Invalid address for the return parameter was specified. |

26.3.2.17.21 XMLElementContents

Property: XMLElementContents as Boolean

Description

Specifies if element contents are searched when [AdvancedXMLSearch](#)¹³¹¹ is true. The default is true.

Errors

| | |
|------|---|
| 3500 | The object is no longer valid. |
| 3501 | Invalid address for the return parameter was specified. |

26.3.2.17.22 XMLElementNames

Property: XMLElementNames as Boolean

Description

Specifies if element names are searched when [AdvancedXMLSearch](#)¹³¹¹ is true. The default is true.

Errors

| | |
|------|---|
| 3500 | The object is no longer valid. |
| 3501 | Invalid address for the return parameter was specified. |

26.3.2.17.23 XMLPI

Property: XMLPI as Boolean

Description

Specifies if XML processing instructions are searched when [AdvancedXMLSearch](#)¹³¹¹ is true. The default is true.

Errors

| | |
|------|--------------------------------|
| 3500 | The object is no longer valid. |
|------|--------------------------------|

| | |
|------|---|
| 3501 | Invalid address for the return parameter was specified. |
|------|---|

26.3.2.17.24 XMLRest

Property: XMLRest as Boolean

Description

Specifies if the rest of the XML (which is not covered by the other XML search properties) is searched when [AdvancedXMLSearch](#)¹³¹¹ is true. The default is true.

Errors

| | |
|------|---|
| 3500 | The object is no longer valid. |
| 3501 | Invalid address for the return parameter was specified. |

26.3.2.18 FindInFilesResult

Properties and Methods

Standard automation properties

[Application](#)¹³¹⁷

[Parent](#)¹³¹⁸

[Count](#)¹³¹⁸

[Item](#)¹³¹⁸

[Path](#)¹³¹⁸

[Document](#)¹³¹⁸

Description

This object represents a file that matched the search criteria. It contains a list of [FindInFilesResultMatch](#)¹³¹⁹ objects that describe the matching position.

26.3.2.18.1 Application

Property: Application as [Application](#)¹¹⁷² (read-only)

Description

Access the XMLSpy application object.

Errors

| | |
|------|---|
| 3700 | The object is no longer valid. |
| 3701 | Invalid address for the return parameter was specified. |

26.3.2.18.2 Count

Property: Count as long (read-only)

Description

Count of elements in this collection.

26.3.2.18.3 Document

Property: Path as [Document](#)¹²⁶⁴ (read-only)

Description

This property returns the [Document](#)¹²⁶⁴ object if the matched file is already open in XMLSpy.

Errors

| | |
|------|---|
| 3700 | The object is no longer valid. |
| 3701 | Invalid address for the return parameter was specified. |

26.3.2.18.4 Item

Method: Item(n as long) as [FindInFilesResultMatch](#)¹³¹⁹

Description

Gets the element with the index n from this collection. The first item has index 1.

26.3.2.18.5 Parent

Property: Parent as [FindInFilesResults](#)¹³²¹ (read-only)

Description

Access the parent of the object.

Errors

| | |
|------|---|
| 3700 | The object is no longer valid. |
| 3701 | Invalid address for the return parameter was specified. |

26.3.2.18.6 Path

Property: Path as String (read-only)

Description

Returns the path of the file that matched the search criteria.

Errors

| | |
|------|---|
| 3700 | The object is no longer valid. |
| 3701 | Invalid address for the return parameter was specified. |

26.3.2.19 FindInFilesResultMatch

Properties and Methods

Standard automation properties

[Application](#) ¹³¹⁹

[Parent](#) ¹³²⁰

[Line](#) ¹³²⁰

[Position](#) ¹³²⁰

[Length](#) ¹³¹⁹

[LineText](#) ¹³²⁰

[Replaced](#) ¹³²¹

Description

Contains the exact position in the file of the matched string.

26.3.2.19.1 Application

Property: Application as [Application](#) ¹¹⁷² (read-only)

Description

Access the XMLSpy application object.

Errors

| | |
|------|---|
| 3800 | The object is no longer valid. |
| 3801 | Invalid address for the return parameter was specified. |

26.3.2.19.2 Length

Property: Length as Long (read-only)

Description

Returns the length of the matched string.

Errors

| | |
|------|---|
| 3800 | The object is no longer valid. |
| 3801 | Invalid address for the return parameter was specified. |

26.3.2.19.3 Line

Property: Line as Long (read-only)

Description

Returns the line number of the match. The line numbering starts with 0.

Errors

| | |
|------|---|
| 3800 | The object is no longer valid. |
| 3801 | Invalid address for the return parameter was specified. |

26.3.2.19.4 LineText

Property: LineText as String (read-only)

Description

Returns the text of the line.

Errors

| | |
|------|---|
| 3800 | The object is no longer valid. |
| 3801 | Invalid address for the return parameter was specified. |

26.3.2.19.5 Parent

Property: Parent as [FindInFilesResult](#)¹³¹⁷ (read-only)

Description

Access the parent of the object.

Errors

| | |
|------|---|
| 3800 | The object is no longer valid. |
| 3801 | Invalid address for the return parameter was specified. |

26.3.2.19.6 Position

Property: Position as Long (read-only)

Description

Returns the start position of the match in the line. The position numbering starts with 0.

Errors

| | |
|------|---|
| 3800 | The object is no longer valid. |
| 3801 | Invalid address for the return parameter was specified. |

26.3.2.19.7 Replaced

Property: Replaced as Boolean (read-only)

Description

True if the matched string was replaced.

Errors

| | |
|------|---|
| 3800 | The object is no longer valid. |
| 3801 | Invalid address for the return parameter was specified. |

26.3.2.20 FindInFilesResults

Properties and Methods

Standard automation properties

[Application](#)¹³²¹

[Parent](#)¹³²²

[Count](#)¹³²²

[Item](#)¹³²²

Description

This is the result of the [FindInFiles](#)¹¹⁷⁹ method. It is a list of [FindInFilesResult](#)¹³¹⁷ objects.

26.3.2.20.1 Application

Property: Application as [Application](#)¹¹⁷² (read-only)

Description

Access the XMLSpy application object.

Errors

| | |
|------|---|
| 3600 | The object is no longer valid. |
| 3601 | Invalid address for the return parameter was specified. |

26.3.2.20.2 Count

Property: Count as long (read-only)

Description

Count of elements in this collection.

26.3.2.20.3 Item

Method: Item(n as long) as [FindInFilesResult](#)¹³¹⁷

Description

Gets the element with the index n from this collection. The first item has index 1.

26.3.2.20.4 Parent

Property: Parent as [Application](#)¹¹⁷² (read-only)

Description

Access the parent of the object.

Errors

| | |
|------|---|
| 3600 | The object is no longer valid. |
| 3601 | Invalid address for the return parameter was specified. |

26.3.2.21 GenerateSampleXMLDlg

Properties and Methods

Standard automation properties

[Application](#)¹³²³

[Parent](#)¹³²⁶

[NonMandatoryAttributes](#)¹³²⁵

[NonMandatoryElements](#)¹³²⁵

[RepeatCount](#)¹³²⁷

[FillAttributesWithSampleData](#)¹³²⁴

[FillElementsWithSampleData](#)¹³²⁴

[ContentOfNillableElementsIsNonMandatory](#)¹³²⁴

[TryToUseNonAbstractTypes](#)¹³²⁸

[SchemaOrDTDAssignment](#)¹³²⁷

[LocalNameOfRootElement](#)¹³²⁵

[NamespaceURIOfRootElement](#)¹³²⁵

[OptionsDialogAction](#)¹³²⁶

Properties that are no longer supported

[TakeFirstChoice - obsolete](#) ¹³²⁷
[FillWithSampleData - obsolete](#) ¹³²⁴
[Optimization - obsolete](#) ¹³²⁶

Description

Used to set the parameters for the generation of sample XML instances based on a W3C schema or DTD.

26.3.2.21.1 Application

Property: Application as [Application](#) ¹¹⁷² (read-only)

Description

Access the XMLSpy application object.

Errors

| | |
|------|---|
| 2200 | The object is no longer valid. |
| 2201 | Invalid address for the return parameter was specified. |

26.3.2.21.2 ChoiceMode

Property: ChoiceMode as [SPYSampleXMLGenerationChoiceMode](#) ¹⁴³⁰

Description

Specifies which elements will be generated.

Errors

| | |
|------|---|
| 2200 | The object is no longer valid. |
| 2201 | Invalid address for the return parameter was specified. |

26.3.2.21.3 ConsiderSampleValueHints

Property: ConsiderSampleValueHints as Boolean

Description

Selects whether to use [SampleValueHints](#) ¹³²⁷ or not.

Errors

| | |
|------|---|
| 2200 | The object is no longer valid. |
| 2201 | Invalid address for the return parameter was specified. |

26.3.2.21.4 ContentOfNillableElementsIsNonMandatory

Property: ContentOfNillableElementsIsNonMandatory as Boolean

Description

If true, the contents of elements that are nillable will not be treated as mandatory.

Errors

| | |
|------|---|
| 2200 | The object is no longer valid. |
| 2201 | Invalid address for the return parameter was specified. |

26.3.2.21.5 FillAttributesWithSampleData

Property: FillAttributesWithSampleData as Boolean

Description

If true, attributes will have sample content.

Errors

| | |
|------|---|
| 2200 | The object is no longer valid. |
| 2201 | Invalid address for the return parameter was specified. |

26.3.2.21.6 FillElementsWithSampleData

Property: FillElementsWithSampleData as Boolean

Description

If true, elements will have sample content.

Errors

| | |
|------|---|
| 2200 | The object is no longer valid. |
| 2201 | Invalid address for the return parameter was specified. |

26.3.2.21.7 FillWithSampleData - obsolete

Property: FillWithSampleData as Boolean

Description

Do no longer access this property. Use [FillAttributesWithSampleData](#)¹³²⁴ and [FillElementsWithSampleData](#)¹³²⁴, instead.

Errors

| | |
|------|---------------------------------------|
| 0001 | The property is no longer accessible. |
|------|---------------------------------------|

26.3.2.21.8 LocalNameOfRootElement

Property: LocalNameOfRootElement as String

Description

Specifies the local name of the root element for the generated sample XML.

Errors

| | |
|------|---|
| 2200 | The object is no longer valid. |
| 2201 | Invalid address for the return parameter was specified. |

26.3.2.21.9 NamespaceURIOfRootElement

Property: NamespaceURIOfRootElement as String

Description

Specifies the namespace URI of the root element for the generated sample XML.

Errors

| | |
|------|---|
| 2200 | The object is no longer valid. |
| 2201 | Invalid address for the return parameter was specified. |

26.3.2.21.10 NonMandatoryAttributes

Property: NonMandatoryAttributes as Boolean

Description

If true attributes which are not mandatory are created in the sample XML instance file.

Errors

| | |
|------|---|
| 2200 | The object is no longer valid. |
| 2201 | Invalid address for the return parameter was specified. |

26.3.2.21.11 NonMandatoryElements

Property: NonMandatoryElements as Boolean

Description

If `true`, elements which are not mandatory are created in the sample XML instance file.

Errors

| | |
|------|---|
| 2200 | The object is no longer valid. |
| 2201 | Invalid address was specified for the return parameter. |

26.3.2.21.12 Optimization - obsolete

Property: Optimization as [SPYSampleXMLGenerationOptimization](#)¹⁴³⁰

Description

Do not use this property any longer. Use ChoiceMode and NonMandatoryElements.

Errors

| | |
|------|---------------------------------------|
| 0001 | The property is no longer accessible. |
|------|---------------------------------------|

26.3.2.21.13 OptionsDialogAction

Property: OptionsDialogAction as [SPYDialogAction](#)¹⁴²⁵

Description

To allow your script to fill in the default values and let the user see and react on the dialog, set this property to the value `spyDialogUserInput(2)`. If you want your script to define all the options in the schema documentation dialog without any user interaction necessary, use `spyDialogOK(0)`. Default is `spyDialogOK`.

Errors

| | |
|------|---|
| 2200 | The object is no longer valid. |
| 2201 | Invalid value has been used to set the property.
Invalid address for the return parameter was specified. |

26.3.2.21.14 Parent

Property: Parent as [Dialogs](#)¹²⁶¹ (read-only)

Description

Access the parent of the object.

Errors

| | |
|------|---|
| 2200 | The object is no longer valid. |
| 2201 | Invalid address for the return parameter was specified. |

26.3.2.21.15 RepeatCount

Property: RepeatCount as long

Description

Number of elements to create for repeated types.

Errors

| | |
|------|---|
| 2200 | The object is no longer valid. |
| 2201 | Invalid address for the return parameter was specified. |

26.3.2.21.16 SampleValueHints

Property: SampleValueHints as [SPYSampleXMLGenerationSampleValueHints](#)¹⁴³¹

Description

Specifies how to select data for the generated sample file.

Errors

| | |
|------|---|
| 2200 | The object is no longer valid. |
| 2201 | Invalid address for the return parameter was specified. |

26.3.2.21.17 SchemaOrDTDAssignment

Property: SchemaOrDTDAssignment as [SPYSampleXMLGenerationSchemaOrDTDAssignment](#)¹⁴³¹

Description

Specifies in which way a reference to the related schema or DTD - which is this document - will be generated into the sample XML.

Errors

| | |
|------|---|
| 2200 | The object is no longer valid. |
| 2201 | Invalid address for the return parameter was specified. |

26.3.2.21.18 TakeFirstChoice - obsolete

Property: TakeFirstChoice as Boolean

Description

Do no longer use this property.

Errors

| | |
|------|---------------------------------------|
| 0001 | The property is no longer accessible. |
|------|---------------------------------------|

26.3.2.21.19 [TryToUseNonAbstractTypes](#)

Property: TryToUseNonAbstractTypes as Boolean

Description

If true, tries to use a non-abstract type for xsi:type, if element has an abstract type.

Errors

| | |
|------|---|
| 2200 | The object is no longer valid. |
| 2201 | Invalid address for the return parameter was specified. |

26.3.2.22 [GridView](#)**Methods**

[Deselect](#) ¹³³¹

[Select](#) ¹³³¹

[SetFocus](#) ¹³³¹

Properties

[CurrentFocus](#) ¹³³¹

[IsVisible](#) ¹³³¹

Description

GridView Class

26.3.2.22.1 [Events](#)26.3.2.22.1.1 [OnBeforeDrag](#)

Event: OnBeforeDrag() as Boolean

XMLSpy scripting environment - VBScript:

```
Function On_BeforeDrag()
    ' On_BeforeStartEditing = False ' to prohibit dragging
End Function
```

XMLSpy scripting environment - JScript:

```
function On_BeforeDrag()
{
    // return false; /* to prohibit dragging */
}
```

```
}

```

XMLSpy IDE Plugin:

```
IXMLSpyPlugIn.OnEvent (4, ...) // nEventId = 4

```

Description

This event gets fired on an attempt to drag an XMLData element on the grid view. Return *false* to prevent dragging the data element to a different position.

26.3.2.22.1.2 OnBeforeDrop

Event: OnBeforeDrop(objXMLData as [XMLData](#)¹³⁷³) as Boolean

XMLSpy scripting environment - VBScript:

```
Function On_BeforeDrop(objXMLData)
    ' On_BeforeStartEditing = False ' to prohibit dropping
End Function

```

XMLSpy scripting environment - JScript:

```
function On_BeforeDrop(objXMLData)
{
    // return false; /* to prohibit dropping */
}

```

XMLSpy IDE Plugin:

```
IXMLSpyPlugIn.OnEvent (5, ...) // nEventId = 5

```

Description

This event gets fired on an attempt to drop a previously dragged XMLData element on the grid view. Return *false* to prevent the data element to be moved from its original position to the drop destination position.

26.3.2.22.1.3 OnBeforeStartEditing

Event: OnBeforeStartEditing(objXMLData as [XMLData](#)¹³⁷³, bEditingName as Boolean) as Boolean

XMLSpy scripting environment - VBScript:

```
Function On_BeforeStartEditing(objXMLData, bEditingName)
    ' On_BeforeStartEditing = False ' to prohibit editing the field
End Function

```

XMLSpy scripting environment - JScript:

```
function On_BeforeStartEditing(objXMLData, bEditingName)
{
    // return false; /* to prohibit editing the field */
}

```

XMLSpy IDE Plugin:

IXMLSpyPlugIn.OnEvent (1, ...) // nEventId = 1

Description

This event gets fired before the editing mode for a grid cell gets entered. If the parameter *bEditingName* is true, the name part of the element will be edited, if its value is false, the value part will be edited.

26.3.2.22.1.4 OnEditingFinished

Event: OnEditingFinished(objXMLData as [XMLData](#)¹³⁷³, bEditingName as Boolean)

XMLSpy scripting environment - VBScript:

```
Function On_EditingFinished(objXMLData, bEditingName)
End Function
```

XMLSpy scripting environment - JScript:

```
function On_EditingFinished(objXMLData, bEditingName)
{
}
```

XMLSpy IDE Plugin:

IXMLSpyPlugIn.OnEvent (2, ...) // nEventId = 2

Description

This event gets fired when the editing mode of a grid cell is exited. The parameter *bEditingName* specifies if the name part of the element has been edited.

26.3.2.22.1.5 OnFocusChanged

Event: OnFocusChanged(objXMLData as [XMLData](#)¹³⁷³, bSetFocus as Boolean, bEditingName as Boolean)

XMLSpy scripting environment - VBScript:

```
Function On_FocusChanged(objXMLData, bSetFocus, bEditingName)
End Function
```

XMLSpy scripting environment - JScript:

```
function On_FocusChanged(objXMLData, bSetFocus, bEditingName)
{
}
```

XMLSpy IDE Plugin:

IXMLSpyPlugIn.OnEvent (3, ...) // nEventId = 3

Description

This event gets fired whenever a grid cell receives or loses the cursor focus. If the parameter *bEditingName* is true, focus of the name part of the grid element has changed. Otherwise, focus of the value part has changed.

26.3.2.22.2 CurrentFocus

Property: CurrentFocus as [XMLData](#)¹³⁷³

Description

Holds the XML element with the current focus. This property is read-only.

26.3.2.22.3 Deselect

Method: Deselect(*pData* as [XMLData](#)¹³⁷³)

Description

Deselects the element *pData* in the grid view.

26.3.2.22.4 IsVisible

Property: IsVisible as Boolean

Description

True if the grid view is the active view of the document. This property is read-only.

26.3.2.22.5 Select

Method: Select (*pData* as [XMLData](#)¹³⁷³)

Description

Selects the XML element *pData* in the grid view.

26.3.2.22.6 SetFocus

Method: SetFocus (*pFocusData* as [XMLData](#)¹³⁷³)

Description

Sets the focus to the element *pFocusData* in the grid view.

26.3.2.23 JSONSchemaDocumentationDlg

This object combines offers options for the generation of documentation of JSON Schemas, as they are available through user interface dialog boxes in XMLSpy. The document generation options are initialized with the values used during the last generation of JSON Schema documentation. However, before using the object you have to set the [OutputFile](#)¹³³⁸ property to a valid file path. Use [OptionsDialogAction](#)¹³³⁸, [OutputFileDialogAction](#)¹³³⁹ and [ShowProgressBar](#)¹³⁴¹ to specify the level of user interaction desired. You can use [IncludeAll](#)¹³³⁵ and [AllDetails](#)¹³³³ to set whole option groups at once or the individual properties to operate on a finer granularity.

Properties and Methods

Standard automation properties

[Application](#) ¹³³³

[Parent](#) ¹³³⁹

Output options

[MultipleOutputFiles](#) ¹³³⁸

[OptionsDialogAction](#) ¹³³⁸

[OutputFile](#) ¹³³⁸

[OutputFileDialogAction](#) ¹³³⁹

[ShowProgressBar](#) ¹³⁴¹

[ShowResult](#) ¹³⁴²

Document design and layout

[SPSFile](#) ¹³⁴⁴

[UseFixedDesign](#) ¹³⁴⁴

Document generation options and methods

[OutputFormat](#) ¹³³⁹

[UseFixedDesign](#) ¹³⁴⁴

[SPSFile](#) ¹³⁴⁴

[EmbedDiagrams](#) ¹³³⁴

[DiagramFormat](#) ¹³³³

[MultipleOutputFiles](#) ¹³³⁸

[EmbedCSSInHTML](#) ¹³³⁴

[CreateDiagramsFolder](#) ¹³³³

[GenerateRelativeLinks](#) ¹³³⁴

[IncludeAll](#) ¹³³⁵

[IncludeArrayItems](#) ¹³³⁵

[IncludeDefinitions](#) ¹³³⁵

[IncludeExternalSchemas](#) ¹³³⁶

[IncludeOperatorSubschemas](#) ¹³³⁶

[IncludeOverview](#) ¹³³⁶

[IncludePatternProperties](#) ¹³³⁶

[IncludeProperties](#) ¹³³⁷

[IncludePropertyWildcards](#) ¹³³⁷

[IncludeSchemaDependencies](#) ¹³³⁷

[AllDetails](#) ¹³³³

[ShowArrayItems](#) ¹³³⁹

[ShowDiagram](#) ¹³⁴⁰

[ShowEnumerations](#) ¹³⁴⁰

[ShowLocation](#) ¹³⁴⁰

[ShowOperators](#) ¹³⁴¹

[ShowProperties](#) ¹³⁴¹

[ShowPropertyDetails](#) ¹³⁴²

[ShowSchemaDetails](#) ¹³⁴²

[ShowSourceCode](#) ¹³⁴³

[ShowSpecifying](#) ¹³⁴³

[ShowType](#) ¹³⁴³

[ShowTypeConstraints](#)¹³⁴⁴
[ShowUsedBy](#)¹³⁴⁴

26.3.2.23.1 AllDetails

Method: AllDetails (i_bDetailsOn as Boolean)

Description

Use this method to turn all details options on or off.

Errors

| | |
|------|--------------------------------|
| 2900 | The object is no longer valid. |
|------|--------------------------------|

26.3.2.23.2 Application

Property: Application as [Application](#)¹¹⁷² (read-only)

Description

Access the XMLSpy application object.

Errors

| | |
|------|---|
| 2900 | The object is no longer valid. |
| 2901 | Invalid address for the return parameter was specified. |

26.3.2.23.3 CreateDiagramsFolder

Property: CreateDiagramsFolder as Boolean

Description

Set this property to true to create a directory for the created images. Otherwise the diagrams will be created in the same folder as the documentation. This property is only available when the diagrams are not embedded. The default for the first run is false.

Errors

| | |
|------|---|
| 2900 | The object is no longer valid. |
| 2901 | Invalid address for the return parameter was specified. |

26.3.2.23.4 DiagramFormat

Property: DiagramFormat as [SPYImageKind](#)¹⁴²⁷

Description

This property specifies the generated diagram image type. This property is not available for HTML documentation. The property is initialized with the value used during the last call to [Document.GenerateJSONSchemaDocumentation](#)¹²⁸¹. The default for the first run is PNG.

Errors

| | |
|------|---|
| 2900 | The object is no longer valid. |
| 2901 | Invalid address for the return parameter was specified. |

26.3.2.23.5 EmbedCSSInHTML

Property: EmbedCSSInHTML as Boolean

Description

Set this property to true if you want to embed the CSS data in the generated HTML document. Otherwise a separate file will be created and linked. This property is only available for HTML documentation. The default for the first run is true.

Errors

| | |
|------|---|
| 2900 | The object is no longer valid. |
| 2901 | Invalid address for the return parameter was specified. |

26.3.2.23.6 EmbedDiagrams

Property: EmbedDiagrams as Boolean

Description

Set this property to true if you want to embed the diagrams in the generated document. This property is not available for HTML documentation. The property is initialized with the value used during the last call to [Document.GenerateJSONSchemaDocumentation](#)¹²⁸¹. The default for the first run is true.

Errors

| | |
|------|---|
| 2900 | The object is no longer valid. |
| 2901 | Invalid address for the return parameter was specified. |

26.3.2.23.7 GenerateRelativeLinks

Property: GenerateRelativeLinks as Boolean

Description

Set this property to true if you want to create relative paths to local files. This property is not available for HTML documentation. The property is initialized with the value used during the last call to [Document.GenerateJSONSchemaDocumentation](#)¹²⁸¹. The default for the first run is false.

Errors

| | |
|------|---|
| 2900 | The object is no longer valid. |
| 2901 | Invalid address for the return parameter was specified. |

26.3.2.23.8 **IncludeAll**

Method: IncludeAll (i_bInclude as Boolean)

Description

Use this method to mark or unmark all include options.

Errors

| | |
|------|--------------------------------|
| 2900 | The object is no longer valid. |
|------|--------------------------------|

26.3.2.23.9 **IncludeArrayItems**

Property: IncludeArrayItems as Boolean

Description

Set this property to true to include array items in the JSON Schema documentation. The property is initialized with the value used during the last call to [Document.GenerateJSONSchemaDocumentation](#)¹²⁸¹. The default for the first run is true.

Errors

| | |
|------|---|
| 2900 | The object is no longer valid. |
| 2901 | Invalid address for the return parameter was specified. |

26.3.2.23.10 **IncludeDefinitions**

Property: IncludeDefinitions as Boolean

Description

Set this property to true to include definitions in the JSON Schema documentation. The property is initialized with the value used during the last call to [Document.GenerateJSONSchemaDocumentation](#)¹²⁸¹. The default for the first run is true.

Errors

| | |
|------|---|
| 2900 | The object is no longer valid. |
| 2901 | Invalid address for the return parameter was specified. |

26.3.2.23.11 IncludeExternalSchemas

Property: IncludeExternalSchemas as Boolean

Description

Set this property to true to include external in the JSON Schema documentation. The property is initialized with the value used during the last call to [Document.GenerateJSONSchemaDocumentation](#)¹²⁸¹. The default for the first run is true.

Errors

| | |
|------|---|
| 2900 | The object is no longer valid. |
| 2901 | Invalid address for the return parameter was specified. |

26.3.2.23.12 IncludeOperatorSubschemas

Property: IncludeOperatorSubschemas as Boolean

Description

Set this property to true to include operator subschemas in the JSON Schema documentation. The property is initialized with the value used during the last call to [Document.GenerateJSONSchemaDocumentation](#)¹²⁸¹. The default for the first run is true.

Errors

| | |
|------|---|
| 2900 | The object is no longer valid. |
| 2901 | Invalid address for the return parameter was specified. |

26.3.2.23.13 IncludeOverview

Property: IncludeOverview as Boolean

Description

Set this property to true to include an overview of the JSON Schema. The property is initialized with the value used during the last call to [Document.GenerateJSONSchemaDocumentation](#)¹²⁸¹. The default for the first run is true.

Errors

| | |
|------|---|
| 2900 | The object is no longer valid. |
| 2901 | Invalid address for the return parameter was specified. |

26.3.2.23.14 IncludePatternProperties

Property: IncludePatternProperties as Boolean

Description

Set this property to true to include pattern properties in the JSON Schema documentation. The property is initialized with the value used during the last call to [Document.GenerateJSONSchemaDocumentation](#)¹²⁸¹. The default for the first run is true.

Errors

| | |
|------|---|
| 2900 | The object is no longer valid. |
| 2901 | Invalid address for the return parameter was specified. |

26.3.2.23.15 [IncludeProperties](#)

Property: IncludeProperties as Boolean

Description

Set this property to true to include properties in the JSON Schema documentation. The property is initialized with the value used during the last call to [Document.GenerateJSONSchemaDocumentation](#)¹²⁸¹. The default for the first run is true.

Errors

| | |
|------|---|
| 2900 | The object is no longer valid. |
| 2901 | Invalid address for the return parameter was specified. |

26.3.2.23.16 [IncludePropertyWildcards](#)

Property: IncludePropertyWildcrads as Boolean

Description

Set this property to true to include property wildcards in the JSON Schema documentation. The property is initialized with the value used during the last call to [Document.GenerateJSONSchemaDocumentation](#)¹²⁸¹. The default for the first run is true.

Errors

| | |
|------|---|
| 2900 | The object is no longer valid. |
| 2901 | Invalid address for the return parameter was specified. |

26.3.2.23.17 [IncludeSchemaDependencies](#)

Property: IncludeSchemaDependencies as Boolean

Description

Set this property to true to include schema dependencies in the JSON Schema documentation. The property is initialized with the value used during the last call to [Document.GenerateJSONSchemaDocumentation](#)¹²⁸¹. The default for the first run is true.

Errors

| | |
|------|---|
| 2900 | The object is no longer valid. |
| 2901 | Invalid address for the return parameter was specified. |

26.3.2.23.18 MultipleOutputFiles

Property: MultipleOutputFiles as Boolean

Description

Set this property to true to split the documentation into multiple files by schema item. The property is initialized with the value used during the last call to [Document.GenerateJSONSchemaDocumentation](#)¹²⁸¹. The default for the first run is false.

Errors

| | |
|------|---|
| 2900 | The object is no longer valid. |
| 2901 | Invalid value has been used to set the property.
Invalid address for the return parameter was specified. |

26.3.2.23.19 OptionsDialogAction

Property: OptionsDialogAction as [SPYDialogAction](#)¹⁴²⁵

Description

To allow your script to fill in the default values and let the user see and react to the dialog, set this property to the value *spyDialogUserInput(2)*. If you want your script to define all the options in the schema documentation dialog without any user interaction, use *spyDialogOK(0)*. Default is *spyDialogOK*.

Errors

| | |
|------|---|
| 2900 | The object is no longer valid. |
| 2901 | Invalid value has been used to set the property.
Invalid address for the return parameter was specified. |

26.3.2.23.20 OutputFile

Property: OutputFile as String

Description

Full path and name of the file that will contain the generated documentation. In case of HTML output, additional '.png' files will be generated based on this filename. The default value for this property is an empty string and needs to be replaced before using this object in a call to [Document.GenerateJSONSchemaDocumentation](#)¹²⁸¹.

Errors

| | |
|------|---|
| 2900 | The object is no longer valid. |
| 2901 | Invalid address for the return parameter was specified. |

26.3.2.23.21 OutputFileDialogAction

Property: OutputFileDialogAction as [SPYDialogAction](#)¹⁴²⁵

Description

To allow the user to select the output file with a file selection dialog, set this property to *spyDialogUserInput(2)*. If the value stored in [OutputFile](#)¹³⁵² should be taken and no user interaction should occur, use *spyDialogOK(0)*. Default is *spyDialogOK*.

Errors

| | |
|------|---|
| 2900 | The object is no longer valid. |
| 2901 | Invalid value has been used to set the property.
Invalid address for the return parameter was specified. |

26.3.2.23.22 OutputFormat

Property: OutputFormat as [SPYSchemaDocumentationFormat](#)¹⁴³²

Description

Defines the kind of documentation that will be generated: HTML (value=0), MS-Word (value=1), or RTF (value=2). The property gets initialized with the value used during the last call to [Document.GenerateJSONSchemaDocumentation](#)¹²⁸¹. The default for the first run is HTML.

Errors

| | |
|------|---|
| 2900 | The object is no longer valid. |
| 2901 | Invalid value has been used to set the property.
Invalid address for the return parameter was specified. |

26.3.2.23.23 Parent

Property: Parent as [Dialogs](#)¹²⁶¹ (read-only)

Description

Access the parent of the object.

Errors

| | |
|------|---|
| 2900 | The object is no longer valid. |
| 2901 | Invalid address for the return parameter was specified. |

26.3.2.23.24 ShowArrayItems

Property: ShowArrayItems as Boolean

Description

Set this property to true to show array items in the schema documentation. The property is initialized with the value used during the last call to [Document.GenerateJSONSchemaDocumentation](#)⁽¹²⁸¹⁾. The default for the first run is true.

Errors

| | |
|------|---|
| 2900 | The object is no longer valid. |
| 2901 | Invalid address for the return parameter was specified. |

26.3.2.23.25 ShowDiagram

Property: ShowDiagram as Boolean

Description

Set this property to true to show definitions as diagrams in the schema documentation. The property is initialized with the value used during the last call to [Document.GenerateJSONSchemaDocumentation](#)⁽¹²⁸¹⁾. The default for the first run is true.

Errors

| | |
|------|---|
| 2900 | The object is no longer valid. |
| 2901 | Invalid address for the return parameter was specified. |

26.3.2.23.26 ShowEnumerations

Property: ShowEnumerations as Boolean

Description

Set this property to true to show the enumerations of definitions. The property is initialized with the value used during the last call to [Document.GenerateJSONSchemaDocumentation](#)⁽¹²⁸¹⁾. The default for the first run is true.

Errors

| | |
|------|---|
| 2900 | The object is no longer valid. |
| 2901 | Invalid address for the return parameter was specified. |

26.3.2.23.27 ShowLocation

Property: ShowLocation as Boolean

Description

Set this property to true to show the location of the JSON Schema. The property is initialized with the value used during the last call to [Document.GenerateJSONSchemaDocumentation](#)⁽¹²⁸¹⁾. The default for the first run is true.

Errors

| | |
|------|---|
| 2900 | The object is no longer valid. |
| 2901 | Invalid address for the return parameter was specified. |

26.3.2.23.28 ShowOperators

Property: ShowOperators as Boolean

Description

Set this property to true to show schema operators in the JSON Schema documentation. The property is initialized with the value used during the last call to [Document.GenerateJSONSchemaDocumentation](#)¹²⁸¹. The default for the first run is true.

Errors

| | |
|------|---|
| 2900 | The object is no longer valid. |
| 2901 | Invalid address for the return parameter was specified. |

26.3.2.23.29 ShowProgressBar

Property: ShowProgressBar as Boolean

Description

Set this property to true to open a window showing the progress of document generation. Use false, to hide it. Default is false.

Errors

| | |
|------|---|
| 2900 | The object is no longer valid. |
| 2901 | Invalid address for the return parameter was specified. |

26.3.2.23.30 ShowProperties

Property: ShowProperties as Boolean

Description

Set this property to true to show the type definition properties. The property is initialized with the value used during the last call to [Document.GenerateJSONSchemaDocumentation](#)¹²⁸¹. The default for the first run is true.

Errors

| | |
|------|---|
| 2900 | The object is no longer valid. |
| 2901 | Invalid address for the return parameter was specified. |

26.3.2.23.31 ShowPropertyDetails

Property: ShowPropertyDetails as Boolean

Description

Set this property to true to show the property details of type definitions. The property is initialized with the value used during the last call to [Document.GenerateJSONSchemaDocumentation](#)¹²⁸¹. The default for the first run is true.

Errors

| | |
|------|---|
| 2900 | The object is no longer valid. |
| 2901 | Invalid address for the return parameter was specified. |

26.3.2.23.32 ShowResult

Property: ShowResult as Boolean

Description

Set this property to true to automatically open the resulting document when generation completes successfully. HTML documentation will be opened in XMLSpy. To show Word documentation, MS-Word will be started. The property gets initialized with the value used during the last call to [Document.GenerateJSONSchemaDocumentation](#)¹²⁸¹. The default for the first run is true.

Errors

| | |
|------|---|
| 2900 | The object is no longer valid. |
| 2901 | Invalid address for the return parameter was specified. |

26.3.2.23.33 ShowSchemaDetails

Property: ShowSchemaDetails as Boolean

Description

Set this property to true to show information about the JSON Schema. The property is initialized with the value used during the last call to [Document.GenerateJSONSchemaDocumentation](#)¹²⁸¹. The default for the first run is true.

Errors

| | |
|------|---|
| 2900 | The object is no longer valid. |
| 2901 | Invalid address for the return parameter was specified. |

26.3.2.23.34 ShowSourceCode

Property: ShowSourceCode as Boolean

Description

Set this property to true to show the XML source code of definitions. The property is initialized with the value used during the last call to [Document.GenerateJSONSchemaDocumentation](#)¹²⁸¹. The default for the first run is true.

Errors

| | |
|------|---|
| 2900 | The object is no longer valid. |
| 2901 | Invalid address for the return parameter was specified. |

26.3.2.23.35 ShowSpecifying

Property: ShowSpecifying as Boolean

Description

Set this property to true to show the specifying schemas and subschemas. The property is initialized with the value used during the last call to [Document.GenerateJSONSchemaDocumentation](#)¹²⁸¹. The default for the first run is true.

Errors

| | |
|------|---|
| 2900 | The object is no longer valid. |
| 2901 | Invalid address for the return parameter was specified. |

26.3.2.23.36 ShowType

Property: ShowType as Boolean

Description

Set this property to true to show the type of definitions in the JSON Schema documentation. The property is initialized with the value used during the last call to [Document.GenerateJSONSchemaDocumentation](#)¹²⁸¹. The default for the first run is true.

Errors

| | |
|------|---|
| 2900 | The object is no longer valid. |
| 2901 | Invalid address for the return parameter was specified. |

26.3.2.23.37 ShowTypeConstraints

Property: ShowTypeConstraints as Boolean

Description

Set this property to true to show type constraints in the JSON Schema documentation. The property is initialized with the value used during the last call to [Document.GenerateJSONSchemaDocumentation](#)¹²⁸¹. The default for the first run is true.

Errors

| | |
|------|---|
| 2900 | The object is no longer valid. |
| 2901 | Invalid address for the return parameter was specified. |

26.3.2.23.38 ShowUsedBy

Property: ShowUsedBy as Boolean

Description

Set this property to true to show the used-by relation for type definitions in the schema documentation. The property is initialized with the value used during the last call to [Document.GenerateJSONSchemaDocumentation](#)¹²⁸¹. The default for the first run is true.

Errors

| | |
|------|---|
| 2900 | The object is no longer valid. |
| 2901 | Invalid address for the return parameter was specified. |

26.3.2.23.39 SPSFile

Property: SPSFile as String

Description

Full path and name of the SPS file that will be used to generate the documentation.

Errors

| | |
|------|---|
| 2900 | The object is no longer valid. |
| 2901 | Invalid address for the return parameter was specified. |

26.3.2.23.40 UseFixedDesign

Property: UseFixedDesign as Boolean

Description

Specifies whether the documentation should be created with a fixed design or with a design specified by a SPS file (which requires StyleVision).

Errors

| | |
|------|---|
| 2900 | The object is no longer valid. |
| 2901 | Invalid address for the return parameter was specified. |

26.3.2.24 SchemaDocumentationDlg

Properties and Methods

Standard automation properties

- [Application](#) ¹³⁴⁶
- [Parent](#) ¹³⁵³

Interaction and visibility properties

- [OutputFile](#) ¹³⁵²
- [OutputFileDialogAction](#) ¹³⁵³
- [OptionsDialogAction](#) ¹³⁵²
- [ShowProgressBar](#) ¹³⁵⁶
- [ShowResult](#) ¹³⁵⁷

Document generation options and methods

- [OutputFormat](#) ¹³⁵³
- [UseFixedDesign](#) ¹³⁵⁹
- [SPSFile](#) ¹³⁵⁸
- [EmbedDiagrams](#) ¹³⁴⁸
- [DiagramFormat](#) ¹³⁴⁷
- [MultipleOutputFiles](#) ¹³⁵²
- [EmbedCSSInHTML](#) ¹³⁴⁷
- [CreateDiagramsFolder](#) ¹³⁴⁷
- [GenerateRelativeLinks](#) ¹³⁴⁸

- [IncludeAll](#) ¹³⁴⁸
- [IncludeIndex](#) ¹³⁵⁰
- [IncludeGlobalAttributes](#) ¹³⁴⁹
- [IncludeGlobalElements](#) ¹³⁴⁹
- [IncludeLocalAttributes](#) ¹³⁵⁰
- [IncludeLocalElements](#) ¹³⁵¹
- [IncludeGroups](#) ¹³⁵⁰
- [IncludeComplexTypes](#) ¹³⁴⁹
- [IncludeSimpleTypes](#) ¹³⁵¹
- [IncludeAttributeGroups](#) ¹³⁴⁸
- [IncludeRedefines](#) ¹³⁵¹
- [IncludeReferencedSchemas](#) ¹³⁵¹

- [AllDetails](#) ¹³⁴⁶
- [ShowDiagram](#) ¹³⁵⁵

[ShowNamespace](#)¹³⁵⁶
[ShowType](#)¹³⁵⁸
[ShowChildren](#)¹³⁵⁴
[ShowUsedBy](#)¹³⁵⁸
[ShowProperties](#)¹³⁵⁶
[ShowSingleFacets](#)¹³⁵⁷
[ShowPatterns](#)¹³⁵⁶
[ShowEnumerations](#)¹³⁵⁵
[ShowAttributes](#)¹³⁵⁴
[ShowIdentityConstraints](#)¹³⁵⁵
[ShowAnnotations](#)¹³⁵⁴
[ShowSourceCode](#)¹³⁵⁷

Description

This object combines options for JSON Schema document generation as they are available through user interface dialog boxes in XMLSpy. The document generation options are initialized with the values used during the last generation of JSON Schema documentation. However, before using the object you have to set the [SetOutputFile](#)¹³⁵² property to a valid file path. Use [OptionsDialogAction](#)¹³⁵², [OutputFileDialogAction](#)¹³⁵³ and [ShowProgressBar](#)¹³⁵⁶ to specify the level of user interaction desired. You can use [IncludeAll](#)¹³⁴⁸ and [AllDetails](#)¹³⁴⁶ to set whole option groups at once or the individual properties to operate on a finer granularity.

26.3.2.24.1 AllDetails

Method: AllDetails (i_bDetailsOn as Boolean)

Description

Use this method to turn all details options on or off.

Errors

| | |
|------|--------------------------------|
| 2900 | The object is no longer valid. |
|------|--------------------------------|

26.3.2.24.2 Application

Property: Application as [Application](#)¹¹⁷² (read-only)

Description

Access the XMLSpy application object.

Errors

| | |
|------|---|
| 2900 | The object is no longer valid. |
| 2901 | Invalid address for the return parameter was specified. |

26.3.2.24.3 CreateDiagramsFolder

Property: CreateDiagramsFolder as Boolean

Description

Set this property to true, to create a directory for the created images. Otherwise the diagrams will be created next to the documentation. This property is only available when the diagrams are not embedded. The default for the first run is false.

Errors

| | |
|------|---|
| 2900 | The object is no longer valid. |
| 2901 | Invalid address for the return parameter was specified. |

26.3.2.24.4 DiagramFormat

Property: DiagramFormat as [SPYImageKind](#)¹⁴²⁷

Description

This property specifies the generated diagram image type. This property is not available for HTML documentation. The property is initialized with the value used during the last call to [Document.GenerateSchemaDocumentation](#)¹²⁸². The default for the first run is PNG.

Errors

| | |
|------|---|
| 2900 | The object is no longer valid. |
| 2901 | Invalid address for the return parameter was specified. |

26.3.2.24.5 EmbedCSSInHTML

Property: EmbedCSSInHTML as Boolean

Description

Set this property to true, to embed the CSS data in the generated HTML document. Otherwise a separate file will be created and linked. This property is only available for HTML documentation. The default for the first run is true.

Errors

| | |
|------|---|
| 2900 | The object is no longer valid. |
| 2901 | Invalid address for the return parameter was specified. |

26.3.2.24.6 EmbedDiagrams

Property: EmbedDiagrams as Boolean

Description

Set this property to true, to embed the diagrams in the generated document. This property is not available for HTML documentation. The property is initialized with the value used during the last call to [Document.GenerateSchemaDocumentation](#)¹²⁸². The default for the first run is true.

Errors

| | |
|------|---|
| 2900 | The object is no longer valid. |
| 2901 | Invalid address for the return parameter was specified. |

26.3.2.24.7 GenerateRelativeLinks

Property: GenerateRelativeLinks as Boolean

Description

Set this property to true, to create relative paths to local files. This property is not available for HTML documentation. The property is initialized with the value used during the last call to [Document.GenerateSchemaDocumentation](#)¹²⁸². The default for the first run is false.

Errors

| | |
|------|---|
| 2900 | The object is no longer valid. |
| 2901 | Invalid address for the return parameter was specified. |

26.3.2.24.8 IncludeAll

Method: IncludeAll (i_bInclude as Boolean)

Description

Use this method to mark or unmark all include options.

Errors

| | |
|------|--------------------------------|
| 2900 | The object is no longer valid. |
|------|--------------------------------|

26.3.2.24.9 IncludeAttributeGroups

Property: IncludeAttributeGroups as Boolean

Description

Set this property to true, to include attribute groups in the schema documentation. The property is initialized with the value used during the last call to [Document.GenerateSchemaDocumentation](#)¹²⁸². The default for the first run is true.

Errors

| | |
|------|---|
| 2900 | The object is no longer valid. |
| 2901 | Invalid address for the return parameter was specified. |

26.3.2.24.10 IncludeComplexTypes

Property: IncludeComplexTypes as Boolean

Description

Set this property to true, to include complex types in the schema documentation. The property is initialized with the value used during the last call to [Document.GenerateSchemaDocumentation](#)¹²⁸². The default for the first run is true.

Errors

| | |
|------|---|
| 2900 | The object is no longer valid. |
| 2901 | Invalid address for the return parameter was specified. |

26.3.2.24.11 IncludeGlobalAttributes

Property: IncludeGlobalAttributes as Boolean

Description

Set this property to true, to include global attributes in the schema documentation. The property is initialized with the value used during the last call to [Document.GenerateSchemaDocumentation](#)¹²⁸². The default for the first run is true.

Errors

| | |
|------|---|
| 2900 | The object is no longer valid. |
| 2901 | Invalid address for the return parameter was specified. |

26.3.2.24.12 IncludeGlobalElements

Property: IncludeGlobalElements as Boolean

Description

Set this property to true, to include global elements in the schema documentation. The property is initialized with the value used during the last call to [Document.GenerateSchemaDocumentation](#)¹²⁸². The default for the first run is true.

Errors

| | |
|------|---|
| 2900 | The object is no longer valid. |
| 2901 | Invalid address for the return parameter was specified. |

26.3.2.24.13 IncludeGroups

Property: IncludeGroups as Boolean

Description

Set this property to true, to include groups in the schema documentation. The property is initialized with the value used during the last call to [Document.GenerateSchemaDocumentation](#)⁽¹²⁸²⁾. The default for the first run is true.

Errors

| | |
|------|---|
| 2900 | The object is no longer valid. |
| 2901 | Invalid address for the return parameter was specified. |

26.3.2.24.14 IncludeIndex

Property: IncludeIndex as Boolean

Description

Set this property to true, to include an index in the schema documentation. The property is initialized with the value used during the last call to [Document.GenerateSchemaDocumentation](#)⁽¹²⁸²⁾. The default for the first run is true.

Errors

| | |
|------|---|
| 2900 | The object is no longer valid. |
| 2901 | Invalid address for the return parameter was specified. |

26.3.2.24.15 IncludeLocalAttributes

Property: IncludeLocalAttributes as Boolean

Description

Set this property to true, to include local attributes in the schema documentation. The property is initialized with the value used during the last call to [Document.GenerateSchemaDocumentation](#)⁽¹²⁸²⁾. The default for the first run is true.

Errors

| | |
|------|---|
| 2900 | The object is no longer valid. |
| 2901 | Invalid address for the return parameter was specified. |

26.3.2.24.16 IncludeLocalElements

Property: IncludeLocalElements as Boolean

Description

Set this property to true, to include local elements in the schema documentation. The property is initialized with the value used during the last call to [Document.GenerateSchemaDocumentation](#)¹²⁸². The default for the first run is true.

Errors

| | |
|------|---|
| 2900 | The object is no longer valid. |
| 2901 | Invalid address for the return parameter was specified. |

26.3.2.24.17 IncludeRedefines

Property: IncludeRedefines as Boolean

Description

Set this property to true, to include redefines in the schema documentation. The property is initialized with the value used during the last call to [Document.GenerateSchemaDocumentation](#)¹²⁸². The default for the first run is true.

Errors

| | |
|------|---|
| 2900 | The object is no longer valid. |
| 2901 | Invalid address for the return parameter was specified. |

26.3.2.24.18 IncludeReferencedSchemas

Property: IncludeReferencedSchemas as Boolean

Description

Set this property to true, to include referenced schemas in the schema documentation. The property is initialized with the value used during the last call to [Document.GenerateSchemaDocumentation](#)¹²⁸². The default for the first run is true.

Errors

| | |
|------|---|
| 2900 | The object is no longer valid. |
| 2901 | Invalid address for the return parameter was specified. |

26.3.2.24.19 IncludeSimpleTypes

Property: IncludeSimpleTypes as Boolean

Description

Set this property to true, to include simple types in the schema documentation. The property is initialized with the value used during the last call to [Document.GenerateSchemaDocumentation](#)¹²⁸². The default for the first run is true.

Errors

| | |
|------|---|
| 2900 | The object is no longer valid. |
| 2901 | Invalid address for the return parameter was specified. |

26.3.2.24.20 MultipleOutputFiles

Property: MultipleOutputFiles as Boolean

Description

Set this property to true, to split the documentation files. The property is initialized with the value used during the last call to [Document.GenerateSchemaDocumentation](#)¹²⁸². The default for the first run is false.

Errors

| | |
|------|---|
| 2900 | The object is no longer valid. |
| 2901 | Invalid value has been used to set the property.
Invalid address for the return parameter was specified. |

26.3.2.24.21 OptionsDialogAction

Property: OptionsDialogAction as [SPYDialogAction](#)¹⁴²⁵

Description

To allow your script to fill in the default values and let the user see and react on the dialog, set this property to the value *spyDialogUserInput(2)*. If you want your script to define all the options in the schema documentation dialog without any user interaction necessary, use *spyDialogOK(0)*. Default is *spyDialogOK*.

Errors

| | |
|------|---|
| 2900 | The object is no longer valid. |
| 2901 | Invalid value has been used to set the property.
Invalid address for the return parameter was specified. |

26.3.2.24.22 OutputFile

Property: OutputFile as String

Description

Full path and name of the file that will contain the generated documentation. In case of HTML output, additional '.png' files will be generated based on this filename. The default value for this property is an empty string and needs to be replaced before using this object in a call to [Document.GenerateSchemaDocumentation](#)¹²⁸².

Errors

| | |
|------|---|
| 2900 | The object is no longer valid. |
| 2901 | Invalid address for the return parameter was specified. |

26.3.2.24.23 OutputFileDialogAction

Property: OutputFileDialogAction as [SPYDialogAction](#)¹⁴²⁵

Description

To allow the user to select the output file with a file selection dialog, set this property to *spyDialogUserInput(2)*. If the value stored in [OutputFile](#)¹³⁵² should be taken and no user interaction should occur, use *spyDialogOK(0)*. Default is *spyDialogOK*.

Errors

| | |
|------|---|
| 2900 | The object is no longer valid. |
| 2901 | Invalid value has been used to set the property.
Invalid address for the return parameter was specified. |

26.3.2.24.24 OutputFormat

Property: OutputFormat as [SPYSchemaDocumentationFormat](#)¹⁴³²

Description

Defines the kind of documentation that will be generated: HTML (value=0), MS-Word (value=1), or RTF (value=2). The property gets initialized with the value used during the last call to [Document.GenerateSchemaDocumentation](#)¹²⁸². The default for the first run is HTML.

Errors

| | |
|------|---|
| 2900 | The object is no longer valid. |
| 2901 | Invalid value has been used to set the property.
Invalid address for the return parameter was specified. |

26.3.2.24.25 Parent

Property: Parent as [Dialogs](#)¹²⁶¹ (read-only)

Description

Access the parent of the object.

Errors

| | |
|------|---|
| 2900 | The object is no longer valid. |
| 2901 | Invalid address for the return parameter was specified. |

26.3.2.24.26 ShowAnnotations

Property: ShowAnnotations as Boolean

Description

Set this property to true, to show the annotations to a type definition in the schema documentation. The property is initialized with the value used during the last call to [Document.GenerateSchemaDocumentation](#)¹²⁸². The default for the first run is true.

Errors

| | |
|------|---|
| 2900 | The object is no longer valid. |
| 2901 | Invalid address for the return parameter was specified. |

26.3.2.24.27 ShowAttributes

Property: ShowAttributes as Boolean

Description

Set this property to true, to show the type definitions attributes in the schema documentation. The property is initialized with the value used during the last call to [Document.GenerateSchemaDocumentation](#)¹²⁸². The default for the first run is true.

Errors

| | |
|------|---|
| 2900 | The object is no longer valid. |
| 2901 | Invalid address for the return parameter was specified. |

26.3.2.24.28 ShowChildren

Property: ShowChildren as Boolean

Description

Set this property to true, to show the children of a type definition as links in the schema documentation. The property is initialized with the value used during the last call to [Document.GenerateSchemaDocumentation](#)¹²⁸². The default for the first run is true.

Errors

| | |
|------|---|
| 2900 | The object is no longer valid. |
| 2901 | Invalid address for the return parameter was specified. |

26.3.2.24.29 ShowDiagram

Property: ShowDiagram as Boolean

Description

Set this property to true, to show type definitions as diagrams in the schema documentation. The property is initialized with the value used during the last call to [Document.GenerateSchemaDocumentation](#)¹²⁸². The default for the first run is true.

Errors

| | |
|------|---|
| 2900 | The object is no longer valid. |
| 2901 | Invalid address for the return parameter was specified. |

26.3.2.24.30 ShowEnumerations

Property: ShowEnumerations as Boolean

Description

Set this property to true, to show the enumerations contained in a type definition in the schema documentation. The property is initialized with the value used during the last call to [Document.GenerateSchemaDocumentation](#)¹²⁸². The default for the first run is true.

Errors

| | |
|------|---|
| 2900 | The object is no longer valid. |
| 2901 | Invalid address for the return parameter was specified. |

26.3.2.24.31 ShowIdentityConstraints

Property: ShowIdentityConstraints as Boolean

Description

Set this property to true, to show a type definitions identity constraints in the schema documentation. The property is initialized with the value used during the last call to [Document.GenerateSchemaDocumentation](#)¹²⁸². The default for the first run is true.

Errors

| | |
|------|---|
| 2900 | The object is no longer valid. |
| 2901 | Invalid address for the return parameter was specified. |

26.3.2.24.32 ShowNamespace

Property: ShowNamespace as Boolean

Description

Set this property to true, to show the namespace of type definitions in the schema documentation. The property is initialized with the value used during the last call to [Document.GenerateSchemaDocumentation](#)¹²⁸². The default for the first run is true.

Errors

| | |
|------|---|
| 2900 | The object is no longer valid. |
| 2901 | Invalid address for the return parameter was specified. |

26.3.2.24.33 ShowPatterns

Property: ShowPatterns as Boolean

Description

Set this property to true, to show the patterns of a type definition in the schema documentation. The property is initialized with the value used during the last call to [Document.GenerateSchemaDocumentation](#)¹²⁸². The default for the first run is true.

Errors

| | |
|------|---|
| 2900 | The object is no longer valid. |
| 2901 | Invalid address for the return parameter was specified. |

26.3.2.24.34 ShowProgressBar

Property: ShowProgressBar as Boolean

Description

Set this property to true, to make the window showing the document generation progress visible. Use false, to hide it. Default is false.

Errors

| | |
|------|---|
| 2900 | The object is no longer valid. |
| 2901 | Invalid address for the return parameter was specified. |

26.3.2.24.35 ShowProperties

Property: ShowProperties as Boolean

Description

Set this property to true, to show the type definition properties in the schema documentation. The property is initialized with the value used during the last call to [Document.GenerateSchemaDocumentation](#)¹²⁸². The default for the first run is true.

Errors

| | |
|------|---|
| 2900 | The object is no longer valid. |
| 2901 | Invalid address for the return parameter was specified. |

26.3.2.24.36 ShowResult

Property: ShowResult as Boolean

Description

Set this property to true, to automatically open the resulting document when generation was successful. HTML documentation will be opened in XMLSpy. To show Word documentation, MS-Word will be started. The property gets initialized with the value used during the last call to [Document.GenerateSchemaDocumentation](#)¹²⁸². The default for the first run is true.

Errors

| | |
|------|---|
| 2900 | The object is no longer valid. |
| 2901 | Invalid address for the return parameter was specified. |

26.3.2.24.37 ShowSingleFacets

Property: ShowSingleFacets as Boolean

Description

Set this property to true, to show the facets of a type definition in the schema documentation. The property is initialized with the value used during the last call to [Document.GenerateSchemaDocumentation](#)¹²⁸². The default for the first run is true.

Errors

| | |
|------|---|
| 2900 | The object is no longer valid. |
| 2901 | Invalid address for the return parameter was specified. |

26.3.2.24.38 ShowSourceCode

Property: ShowSourceCode as Boolean

Description

Set this property to true, to show the XML source code for type definitions in the schema documentation. The property is initialized with the value used during the last call to [Document.GenerateSchemaDocumentation](#)¹²⁸². The default for the first run is true.

Errors

| | |
|------|---|
| 2900 | The object is no longer valid. |
| 2901 | Invalid address for the return parameter was specified. |

26.3.2.24.39 ShowType

Property: ShowType as Boolean

Description

Set this property to true, to show the type of type definitions in the schema documentation. The property is initialized with the value used during the last call to [Document.GenerateSchemaDocumentation](#)¹²⁸². The default for the first run is true.

Errors

| | |
|------|---|
| 2900 | The object is no longer valid. |
| 2901 | Invalid address for the return parameter was specified. |

26.3.2.24.40 ShowUsedBy

Property: ShowUsedBy as Boolean

Description

Set this property to true, to show the used-by relation for type definitions in the schema documentation. The property is initialized with the value used during the last call to [Document.GenerateSchemaDocumentation](#)¹²⁸². The default for the first run is true.

Errors

| | |
|------|---|
| 2900 | The object is no longer valid. |
| 2901 | Invalid address for the return parameter was specified. |

26.3.2.24.41 SPSFile

Property: SPSFile as String

Description

Full path and name of the SPS file that will be used to generate the documentation.

Errors

| | |
|------|---|
| 2900 | The object is no longer valid. |
| 2901 | Invalid address for the return parameter was specified. |

26.3.2.24.42 UseFixedDesign

Property: UseFixedDesign as Boolean

Description

Specifies whether the documentation should be created with a fixed design or with a design specified by a SPS file (which requires StyleVision).

Errors

| | |
|------|---|
| 2900 | The object is no longer valid. |
| 2901 | Invalid address for the return parameter was specified. |

26.3.2.25 SpyProject

Methods

- [CloseProject](#) ¹³⁵⁹
- [SaveProject](#) ¹³⁶⁰
- [SaveProjectAs](#) ¹³⁶⁰

Properties

- [RootItems](#) ¹³⁶⁰
- [ProjectFile](#) ¹³⁶⁰

Description

SpyProject Class

26.3.2.25.1 CloseProject

Declaration: CloseProject(*bDiscardChanges* as Boolean, *bCloseFiles* as Boolean, *bDialog* as Boolean)

Parameters

bDiscardChanges

Set *bDiscardChanges* to FALSE if you want to save the changes of the open project files and the project.

bCloseFiles

Set *bCloseFiles* to TRUE to close all open project files.

bDialog

Show dialogs for user input.

Description

CloseProject closes the current project.

26.3.2.25.2 ProjectFile

Declaration: ProjectFile as String

Description

Path and filename of the project.

26.3.2.25.3 RootItems

Declaration: RootItems as [SpyProjectItems](#) ¹³⁶³

Description

Root level of collection of project items.

26.3.2.25.4 SaveProject

Declaration: SaveProject

Description

SaveProject saves the current project.

26.3.2.25.5 SaveProjectAs

Declaration: SaveProjectAs (strPath as String, bDialog as Boolean)

Parameters

strPath

Full path with file name of new project file.

bDialog

If bDialog is TRUE, a file-dialog will be displayed.

Description

SaveProjectAs stores the project data into a new location.

26.3.2.26 SpyProjectItem

Methods

[Open](#) ¹³⁶¹

Properties

[ChildItems](#) ¹³⁶¹

[ParentItem](#) ¹³⁶²

[FileExtensions](#) ¹³⁶¹

[ItemType](#) ¹³⁶¹

[Name](#) ¹³⁶¹

[Path](#)¹³⁶²
[ValidateWith](#)¹³⁶²
[XMLForXSLTransformation](#)¹³⁶²
[XSLForXMLTransformation](#)¹³⁶²
[XSLTransformationFileExtension](#)¹³⁶²
[XSLTransformationFolder](#)¹³⁶³

Description

SpyProjectItem Class

26.3.2.26.1 ChildItems

Declaration: ChildItems as [SpyProjectItems](#)¹³⁶³

Description

If the item is a folder, ChildItems is the collection of the folder content.

26.3.2.26.2 FileExtensions

Declaration: FileExtensions as String

Description

Used to set the file extensions if the project item is a folder.

26.3.2.26.3 ItemType

Declaration: ItemType as [SPYProjectItemTypes](#)¹⁴²⁹

Description

This property is read-only.

26.3.2.26.4 Name

Declaration: Name as String

Description

Name of the project item. This property is read-only.

26.3.2.26.5 Open

Declaration: Open as [Document](#)¹²⁶⁴

Return Value

The project item opened as document.

Description

Opens the project item.

26.3.2.26.6 ParentItem

Declaration: ParentItem as [SpyProjectItem](#)¹³⁶⁰

Description

Parent item of the current project item. Can be NULL (Nothing) if the project item is a top-level item.

26.3.2.26.7 Path

Declaration: Path as String

Description

Path of project item. This property is read-only.

26.3.2.26.8 ValidateWith

Declaration: ValidateWith as String

Description

Used to set the schema/DTD for validation.

26.3.2.26.9 XMLForXSLTransformation

Declaration: XMLForXSLTransformation as String

Description

Used to set the XML for XSL transformation.

26.3.2.26.10 XSLForXMLTransformation

Declaration: XSLForXMLTransformation as String

Description

Used to set the XSL for XML transformation.

26.3.2.26.11 XSLTransformationFileExtension

Declaration: XSLTransformationFileExtension as String

Description

Used to set the file extension for XSL transformation output files.

26.3.2.26.12 XSLTransformationFolder

Declaration: XSLTransformationFolder as String

Description

Used to set the destination folder for XSL transformation output files.

26.3.2.27 SpyProjectItems

Methods

[AddFile](#) ¹³⁶³

[AddFolder](#) ¹³⁶³

[AddURL](#) ¹³⁶⁴

[RemoveItem](#) ¹³⁶⁴

Properties

[Count](#) ¹³⁶⁴

[Item](#) ¹³⁶⁴

Description

SpyProjectItems Class

26.3.2.27.1 AddFile

Declaration: AddFile (*strPath* as String)

Parameters

strPath

Full path with file name of new project item

Description

The method adds a new file to the collection of project items.

26.3.2.27.2 AddFolder

Declaration: AddFolder (*strName* as String)

Parameters

strName

Name of the new folder.

Description

The method AddFolder adds a folder with the name *strName* to the collection of project items.

26.3.2.27.3 AddURL

Declaration: AddURL (*strURL* as String, *nURLType* as [SPYURLTypes](#)¹⁴³³, *strUser* as String, *strPassword* as String, *bSave* as Boolean)

Description

strURL
URL to open as document.

nURLType
Type of document to open. Set to -1 for auto detection.

strUser
Name of the user if required. Can be empty.

strPassword
Password for authentication. Can be empty.

bSave
Save user and password information.

Description

The method adds an URL item to the project collection.

26.3.2.27.4 Count

Declaration: Count as long

Description

This property gets the count of project items in the collection. The property is read-only.

26.3.2.27.5 Item

Declaration: Item (*n* as long) as [SpyProjectItem](#)¹³⁶⁰

Description

Retrieves the *n*-th element of the collection of project items. The first item has index 1.

26.3.2.27.6 RemoveItem

Declaration: RemoveItem (*pltem* as [SpyProjectItem](#)¹³⁶⁰)

Description

RemoveItem deletes the item *pltem* from the collection of project items.

26.3.2.28 TextImportExportSettings

Properties for import only

[ImportFile](#)¹³⁶⁶

Properties for export only

[DestinationFolder](#)¹³⁶⁵

[FileExtension](#)¹³⁶⁶

[CommentIncluded](#)¹³⁶⁵

[RemoveDelimiter](#)¹³⁶⁷

[RemoveNewline](#)¹³⁶⁷

Properties for import and export

[HeaderRow](#)¹³⁶⁶

[FieldDelimiter](#)¹³⁶⁶

[EnclosingCharacter](#)¹³⁶⁵

[Encoding](#)¹³⁶⁶

[EncodingByteOrder](#)¹³⁶⁶

Description

TextImportExportSettings contains options common to text import and export functions.

26.3.2.28.1 CommentIncluded

Property: CommentIncluded as Boolean

Description

This property tells whether additional comments are added to the generated text file. Default is true. This property is used only when exporting to text files.

26.3.2.28.2 DestinationFolder

Property: DestinationFolder as String

Description

The property DestinationFolder sets the folder where the created files are saved during text export.

26.3.2.28.3 EnclosingCharacter

Property: EnclosingCharacter as [SPYTextEnclosing](#)¹⁴³³

Description

This property defines the character that encloses all field values for import and export. Default is [spyNoEnclosing](#)¹⁴³³.

26.3.2.28.4 Encoding

Property: Encoding as String

Description

The property Encoding sets the character encoding for the text files for importing and exporting.

26.3.2.28.5 EncodingByteOrder

Property: EncodingByteOrder as [SPYEncodingByteOrder](#)¹⁴²⁶

Description

The property EncodingByteOrder sets the byte order for Unicode characters. Default is [spyNONE](#)¹⁴²⁶.

26.3.2.28.6 FieldDelimiter

Property: FieldDelimiter as [SPYTextDelimiters](#)¹⁴³²

Description

The property FieldDelimiter defines the delimiter between the fields during import and export. Default is [spyTabulator](#)¹⁴³².

26.3.2.28.7 FileExtension

Property: FileExtension as String

Description

This property sets the file extension for files created on text export.

26.3.2.28.8 HeaderRow

Property: HeaderRow as Boolean

Description

The property HeaderRow is used during import and export. Set HeaderRow true on import, if the first line of the text file contains the names of the columns. Set HeaderRow true on export, if the first line in the created text files should contain the name of the columns. Default value is true.

26.3.2.28.9 ImportFile

Property: ImportFile as String

Description

This property is used to set the text file for import. The string has to be a full qualified path. See also [Import and Export](#) ¹¹⁴².

26.3.2.28.10 RemoveDelimiter

Property: RemoveDelimiter as Boolean

Description

The property RemoveDelimiter defines whether characters in the text that are equal to the delimiter character are removed. Default is false. This property is used only when exporting to text files.

26.3.2.28.11 RemoveNewline

Property: RemoveNewline as Boolean

Description

The property RemoveNewline defines whether newline characters in the text are removed. Default is false. This property is used only when exporting to text files.

26.3.2.29 TextView

Properties and Methods

[Application](#) ¹³⁶⁹
[Parent](#) ¹³⁷¹

[LineFromPosition](#) ¹³⁷⁰
[PositionFromLine](#) ¹³⁷¹
[LineLength](#) ¹³⁷⁰
[SelText](#) ¹³⁷²
[GetRangeText](#) ¹³⁶⁹
[ReplaceText](#) ¹³⁷¹
[MoveCaret](#) ¹³⁷¹
[GoToLineChar](#) ¹³⁶⁹
[SelectText](#) ¹³⁷²
[SelectionStart](#) ¹³⁷²
[SelectionEnd](#) ¹³⁷²
[Text](#) ¹³⁷³
[LineCount](#) ¹³⁷⁰
[Length](#) ¹³⁷⁰

Description

26.3.2.29.1 Events

26.3.2.29.1.1 *OnBeforeShowSuggestions*

Event: OnBeforeShowSuggestions() as Boolean

Description

This event gets fired before a suggestion window is shown. The [Document](#)¹²⁶⁴ property [Suggestions](#)¹²⁹² contains a string array that is recommended to the user. It is possible to modify the displayed recommendations during this event. Before doing so you have to assign an empty array to the [Suggestions](#)¹²⁹² property. The best location for this is the [OnDocumentOpened](#)¹¹⁷⁴ event. To prevent the suggestion window to show up return false and true to continue its display.

Examples

Given below are examples of how this event can be scripted.

XMLSpy scripting environment - VBScript:

```
Function On_BeforeShowSuggestions()  
End Function
```

XMLSpy scripting environment - JScript:

```
function On_BeforeShowSuggestions()  
{  
}  
}
```

XMLSpy IDE Plugin:

```
IXMLSpyPlugIn.OnEvent (33, ...) // nEventId = 33
```

26.3.2.29.1.2 *OnChar*

Event: OnChar(nChar as Long, bExistSuggestion as Boolean) as Boolean

Description

This event gets fired on each key stroke. The parameter nChar is the key that was pressed and bExistSuggestions tells whether a XMLSpy generated suggestions window is displayed after this key. The [Document](#)¹²⁶⁴ property [Suggestions](#)¹²⁹² contains a string array that is recommended to the user. It is possible to modify the displayed recommendations during this event. Before doing so you have to assign an empty array to the [Suggestions](#)¹²⁹² property. The best location for this is the [OnDocumentOpened](#)¹¹⁷⁴ event. To prevent the suggestion window to show up return false and true to continue its display.

It is also possible to create a new suggestions window when none is provided by XMLSpy. Set the [Document](#)¹²⁶⁴ property [Suggestions](#)¹²⁹² to a string array with your recommendations and return true. This event is fired before the [OnBeforeShowSuggestions](#)¹³⁶⁸ event. If you prevent to show the suggestion window by returning false then [OnBeforeShowSuggestions](#)¹³⁶⁸ is not fired.

Examples

Given below are examples of how this event can be scripted.

XMLSpy scripting environment - VBScript:

```
Function On_Char(nChar, bExistSuggestions)
End Function
```

XMLSpy scripting environment - JScript:

```
function On_Char(nChar, bExistSuggestions)
{
}
```

XMLSpy IDE Plugin:

```
IXMLSpyPlugIn.OnEvent (35, ...) // nEventId = 35
```

26.3.2.29.2 Application

Property: Application as [Application](#)¹¹⁷² (read-only)

Description

Access the XMLSpy application object.

Errors

| | |
|------|---|
| 3900 | The object is no longer valid. |
| 3901 | Invalid address for the return parameter was specified. |

26.3.2.29.3 GetRangeText

Method: GetRangeText(nStart as Long, nEnd as Long) as String

Description

Returns the text in the specified range.

Errors

| | |
|------|---|
| 3900 | The object is no longer valid. |
| 3901 | Invalid address for the return parameter was specified. |

26.3.2.29.4 GoToLineChar

Method: GoToLineChar(nLine as Long, nChar as Long)

Description

Moves the caret to the specified line and character position.

Errors

| | |
|------|--------------------------------|
| 3900 | The object is no longer valid. |
|------|--------------------------------|

| | |
|------|---|
| 3901 | Invalid address for the return parameter was specified. |
|------|---|

26.3.2.29.5 Length

Property: Length as Long

Description

Returns the character count of the document.

Errors

| | |
|------|---|
| 3900 | The object is no longer valid. |
| 3901 | Invalid address for the return parameter was specified. |

26.3.2.29.6 LineCount

Property: LineCount as Long

Description

Returns the number of lines in the document.

Errors

| | |
|------|---|
| 3900 | The object is no longer valid. |
| 3901 | Invalid address for the return parameter was specified. |

26.3.2.29.7 LineFromPosition

Method: LineFromPosition(nCharPos as Long) as Long

Description

Returns the line number of the character position.

Errors

| | |
|------|---|
| 3900 | The object is no longer valid. |
| 3901 | Invalid address for the return parameter was specified. |

26.3.2.29.8 LineLength

Method: LineLength(nLine as Long) as Long

Description

Returns the length of the line.

Errors

| | |
|------|---|
| 3900 | The object is no longer valid. |
| 3901 | Invalid address for the return parameter was specified. |

26.3.2.29.9 MoveCaret

Method: MoveCaret(nDiff as Long)

Description

Moves the caret nDiff characters.

Errors

| | |
|------|---|
| 3900 | The object is no longer valid. |
| 3901 | Invalid address for the return parameter was specified. |

26.3.2.29.10 Parent

Property: Parent as [Document](#)¹²⁶⁴ (read-only)

Description

Access the parent of the object.

Errors

| | |
|------|---|
| 3900 | The object is no longer valid. |
| 3901 | Invalid address for the return parameter was specified. |

26.3.2.29.11 PositionFromLine

Method: PositionFromLine(nLine as Long) as Long

Description

Returns the start position of the line.

Errors

| | |
|------|---|
| 3900 | The object is no longer valid. |
| 3901 | Invalid address for the return parameter was specified. |

26.3.2.29.12 ReplaceText

Method: ReplaceText(nPosFrom as Long, nPosTill as Long, sText as String)

Description

Replaces the text in the specified range.

Errors

| | |
|------|---|
| 3900 | The object is no longer valid. |
| 3901 | Invalid address for the return parameter was specified. |

26.3.2.29.13 SelectionEnd**Property:** SelectionEnd as Long**Description**

Returns/sets the text selection end position.

Errors

| | |
|------|---|
| 3900 | The object is no longer valid. |
| 3901 | Invalid address for the return parameter was specified. |

26.3.2.29.14 SelectionStart**Property:** SelectionStart as Long**Description**

Returns/sets the text selection start position.

Errors

| | |
|------|---|
| 3900 | The object is no longer valid. |
| 3901 | Invalid address for the return parameter was specified. |

26.3.2.29.15 SelectText**Method:** SelectText(nPosFrom as Long, nPosTill as Long)**Description**

Selects the text in the specified range.

Errors

| | |
|------|---|
| 3900 | The object is no longer valid. |
| 3901 | Invalid address for the return parameter was specified. |

26.3.2.29.16 SelText**Property:** SelText as String**Description**

Returns/sets the selected text.

Errors

| | |
|------|---|
| 3900 | The object is no longer valid. |
| 3901 | Invalid address for the return parameter was specified. |

26.3.2.29.17 Text

Property: Text as String

Description

Returns/sets the document text.

Errors

| | |
|------|---|
| 3900 | The object is no longer valid. |
| 3901 | Invalid address for the return parameter was specified. |

26.3.2.30 XMLData

Properties

[Kind](#) ¹³⁸³

[Name](#) ¹³⁸⁴

[TextValue](#) ¹³⁸⁵

[HasChildren](#) ¹³⁸¹

[MayHaveChildren](#) ¹³⁸⁴

[Parent](#) ¹³⁸⁴

Methods

[GetFirstChild](#) ¹³⁷⁹

[GetNextChild](#) ¹³⁸⁰

[GetCurrentChild](#) ¹³⁷⁸

[InsertChild](#) ¹³⁸²

[InsertChildAfter](#) ¹³⁸²

[InsertChildBefore](#) ¹³⁸³

[AppendChild](#) ¹³⁷⁴

[EraseAllChildren](#) ¹³⁷⁵

[EraseChild](#) ¹³⁷⁶

[EraseCurrentChild](#) ¹³⁷⁶

[IsSameNode](#) ¹³⁸³

[CountChildren](#) ¹³⁷⁵

[CountChildrenKind](#) ¹³⁷⁵

[GetChild](#) ¹³⁷⁷

[GetChildAttribute](#) ¹³⁷⁷

[GetChildElement](#)¹³⁷⁸[GetChildKind](#)¹³⁷⁸[GetNamespacePrefixForURI](#)¹³⁷⁹[HasChildrenKind](#)¹³⁸¹[SetTextValueXMLEncoded](#)¹³⁸⁴

Description

The XMLData interface provides direct XML-level access to a document. You can read and directly modify the XML representation of the document. However, please, note the following restrictions:

- The XMLData representation is only valid when the document is shown in grid view or authentic view.
- When in authentic view, additional XMLData elements are automatically inserted as parents of each visible document element. Typically this is an XMLData of kind `spyXMLDataElement` with the [Name](#)¹³⁸⁴ property set to 'Text'.
- When you use the XMLData interface while in a different view mode you will not receive errors, but changes are not reflected to the view and might get lost during the next view switch.

Note also:

- Setting a new text value for an XML element is possible if the element does not have non-text children. A text value can be set even if the element has attributes.
- When setting a new text value for an XML element which has more than one text child, the latter will be deleted and replaced by one new text child.
- When reading the text value of an XML element which has more than one text child, only the value of the first text child will be returned.

Objects of this class represent the different atomic parts of an XML document. See the enumeration type [SPYXMLDataKind](#)¹⁴³⁵ for the available part types. Each part knows its children, thus forming a XMLData tree with [Document.RootElement](#)¹²⁸⁸ at its top. To get the top element of the document content - ignoring the XML header - use [Document.DataRoot](#)¹²⁷⁵. For an examples on how to traverse the XMLData tree, see [GetNextChild](#)¹³⁸⁰.

26.3.2.30.1 AppendChild

Declaration: AppendChild (pNewData as [XMLData](#)¹³⁷³)

Description

AppendChild appends pNewData as last child to the XMLData object.

Errors

| | |
|------|---|
| 1500 | The XMLData object is no longer valid. |
| 1505 | Invalid XMLData kind was specified. |
| 1506 | Invalid address for the return parameter was specified. |
| 1507 | Element cannot have Children |
| 1512 | Cyclic insertion - new data element is already part of document |
| 1514 | Invalid XMLData kind was specified for this position. |

| | |
|------|-------------------------------|
| 1900 | Document must not be modified |
|------|-------------------------------|

Example

```
Dim objCurrentParent As XMLData
Dim objNewChild As XMLData

Set objNewChild = objSpy.ActiveDocument.CreateChild(spyXMLDataElement)
Set objCurrentParent = objSpy.ActiveDocument.RootElement

objCurrentParent.AppendChild objNewChild

Set objNewChild = Nothing
```

26.3.2.30.2 CountChildren

Declaration: CountChildren as long

Description

CountChildren gets the number of children.

Available with TypeLibrary version 1.5

Errors

| | |
|------|--|
| 1500 | The XMLData object is no longer valid. |
|------|--|

26.3.2.30.3 CountChildrenKind

Declaration: CountChildrenKind (*nKind* as [SPYXMLDataKind](#)¹⁴³⁵) as long

Description

CountChildrenKind gets the number of children of the specific kind.

Available with TypeLibrary version 1.5

Errors

| | |
|------|--|
| 1500 | The XMLData object is no longer valid. |
|------|--|

26.3.2.30.4 EraseAllChildren

Declaration: EraseAllChildren

Description

EraseAllChildren deletes all associated children of the XMLData object.

Errors

| | |
|------|--|
| 1500 | The XMLData object is no longer valid. |
| 1900 | Document must not be modified |

Example

The sample erases all elements of the active document.

```
Dim objCurrentParent As XMLData

Set objCurrentParent = objSpy.ActiveDocument.RootElement
objCurrentParent.EraseAllChildren
```

26.3.2.30.5 EraseChild

Method: EraseChild (Child as [XMLData](#)¹³⁷³)

Description

Deletes the given child node.

Errors

| | |
|------|--------------------|
| 1500 | Invalid object. |
| 1506 | Invalid input xml |
| 1510 | Invalid parameter. |

26.3.2.30.6 EraseCurrentChild

Declaration: EraseCurrentChild

Description

EraseCurrentChild deletes the current XMLData child object. Before you call EraseCurrentChild you must initialize an internal iterator with [XMLData.GetFirstChild](#)¹³⁷⁹. After deleting the current child, EraseCurrentChild increments the internal iterator of the XMLData element. No error is returned when the last child gets erased and the iterator is moved past the end of the child list. The next call to EraseCurrentChild however, will return error 1503.

Errors

| | |
|------|---|
| 1500 | The XMLData object is no longer valid. |
| 1503 | No iterator is initialized for this XMLData object, or the iterator points past the last child. |
| 1900 | Document must not be modified |

Examples

```
// -----
// XMLSpy scripting environment - JScript
```

```
// erase all children of XMLData
// -----
// let's get an XMLData element, we assume that the
// cursor selects the parent of a list in grid view
var objList = Application.ActiveDocument.GridView.CurrentFocus;

// the following line would be shorter, of course
//     objList.EraseAllChildren ();

// but we want to demonstrate the usage of EraseCurrentChild
if ((objList != null) && (objList.HasChildren))
{
    try
    {
        objEle = objList.GetFirstChild(-1);
        while (objEle != null)
            objList.EraseCurrentChild();
            // no need to call GetNextChild
    }
    catch (err)
        // 1503 - we reached end of child list
        { if ((err.number & 0xffff) != 1503) throw (err); }
}
```

26.3.2.30.7 GetChild

Declaration: GetChild (*position* as long) as [XMLData](#)¹³⁷³

Return Value

Returns an XML element as XMLData object.

Description

GetChild() returns a reference to the child at the given index (zero-based).

Available with TypeLibrary version 1.5

Errors

| | |
|------|---|
| 1500 | The XMLData object is no longer valid. |
| 1510 | Invalid address for the return parameter was specified. |

26.3.2.30.8 GetChildAttribute

Method: GetChildAttribute (*strName* as string) child as XMLData object (NULL on error)

Description

Retrieves the attribute having the given name.

Errors

| | |
|------|--------------------|
| 1500 | Invalid object. |
| 1510 | Invalid parameter. |

26.3.2.30.9 GetChildElement

Method: GetChildElement (strName as string, nIndex as long) child as XMLData object (NULL on error)

Description

Retrieves the Nth child element with the given name.

Errors

| | |
|------|--------------------|
| 1500 | Invalid object. |
| 1510 | Invalid parameter. |

26.3.2.30.10 GetChildKind

Declaration: GetChildKind (position as long, nKind as [SPYXMLDataKind](#)¹⁴³⁵) as [XMLData](#)¹³⁷³

Return Value

Returns an XML element as XMLData object.

Description

GetChildKind() returns a reference to a child of this kind at the given index (zero-based). The position parameter is relative to the number of children of the specified kind and not to all children of the object.

Available with TypeLibrary version 1.5

Errors

| | |
|------|---|
| 1500 | The XMLData object is no longer valid. |
| 1510 | Invalid address for the return parameter was specified. |

26.3.2.30.11 GetCurrentChild

Declaration: GetCurrentChild as [XMLData](#)¹³⁷³

Return Value

Returns an XML element as XMLData object.

Description

GetCurrentChild gets the current child. Before you call GetCurrentChild you must initialize an internal iterator with [XMLData.GetFirstChild](#)¹³⁷⁹.

Errors

| | |
|------|---|
| 1500 | The XMLData object is no longer valid. |
| 1503 | No iterator is initialized for this XMLData object. |
| 1510 | Invalid address for the return parameter was specified. |

26.3.2.30.12 GetFirstChild

Declaration: GetFirstChild (nKind as [SPYXMLDataKind](#)¹⁴³⁵) as [XMLData](#)¹³⁷³

Return Value

Returns an XML element as XMLData object.

Description

GetFirstChild initializes a new iterator and returns the first child. Set nKind = -1 to get an iterator for all kinds of children.

REMARK: The iterator is stored inside the XMLData object and gets destroyed when the XMLData object gets destroyed. Be sure to keep a reference to this object as long as you want to use [GetCurrentChild](#)¹³⁷⁸, [GetNextChild](#)¹³⁸⁰ or [EraseCurrentChild](#)¹³⁷⁶.

Errors

| | |
|------|---|
| 1500 | The XMLData object is no longer valid. |
| 1501 | Invalid XMLData kind was specified. |
| 1504 | Element has no children of specified kind. |
| 1510 | Invalid address for the return parameter was specified. |

Example

See the example at [XMLData.GetNextChild](#)¹³⁸⁰.

26.3.2.30.13 GetNamespacePrefixForURI

Method: GetNamespacePrefixForURI (strURI as string) strNS as string

Description

Returns the namespace prefix of the supplied URI.

Errors

| | |
|------|--------------------|
| 1500 | Invalid object. |
| 1510 | Invalid parameter. |

26.3.2.30.14 GetNextChild

Declaration: GetNextChild as [XMLData](#)¹³⁷³

Return Value

Returns an XML element as XMLData object.

Description

GetNextChild steps to the next child of this element. Before you call GetNextChild you must initialize an internal iterator with [XMLData.GetFirstChild](#)¹³⁷⁹.

Check for the last child of the element as shown in the sample below.

Errors

| | |
|------|---|
| 1500 | The XMLData object is no longer valid. |
| 1503 | No iterator is initialized for this XMLData object. |
| 1510 | Invalid address for the return parameter was specified. |

Examples

```
' -----
' VBA code snippet - iterate XMLData children
' -----
On Error Resume Next
Set objParent = objSpy.ActiveDocument.RootElement

'get elements of all kinds
Set objCurrentChild = objParent.GetFirstChild(-1)

Do
    'do something useful with the child

    'step to next child
    Set objCurrentChild = objParent.GetNextChild
Loop Until (Err.Number - vbObjectError = 1503)

// -----
// XMLSpy scripting environment - JScript
// iterate through children of XMLData
// -----
try
{
    var objXMLData = ... // initialize somehow
    var objChild = objXMLData.GetFirstChild(-1);

    while (true)
    {
        // do something usefull with objChild

        objChild = objXMLData.GetNextChild();
    }
}
```



```

    }
}
catch (err)
{
    if ((err.number & 0xffff) == 1504)
        ; // element has no children
    else if ((err.number & 0xffff) == 1503)
        ; // last child reached
    else
        throw (err);
}

```

26.3.2.30.15 GetTextValueXMLDecoded

Method: GetTextValueXMLDecoded ()as string

Description

Gets the decoded text value of the XML.

Errors

| | |
|------|--------------------|
| 1500 | Invalid object. |
| 1510 | Invalid parameter. |

26.3.2.30.16 HasChildren

Declaration: HasChildren as Boolean

Description

The property is true if the object is the parent of other XMLData objects. This property is read-only.

Errors

| | |
|------|---|
| 1500 | The XMLData object is no longer valid. |
| 1510 | Invalid address for the return parameter was specified. |

26.3.2.30.17 HasChildrenKind

Declaration: HasChildrenKind (*nKind* as [SPYXMLDataKind](#)¹⁴³⁵) as Boolean

Description

The method returns true if the object is the parent of other XMLData objects of the specific kind.

Available with TypeLibrary version 1.5

Errors

| | |
|------|---|
| 1500 | The XMLData object is no longer valid. |
| 1510 | Invalid address for the return parameter was specified. |

26.3.2.30.18 InsertChild

Declaration: InsertChild (*pNewData* as [XMLData](#)¹³⁷³)

Description

InsertChild inserts the new child before the current child (see also [XMLData.GetFirstChild](#)¹³⁷⁹, [XMLData.GetNextChild](#)¹³⁸⁰ to set the current child).

Errors

| | |
|------|---|
| 1500 | The XMLData object is no longer valid. |
| 1503 | No iterator is initialized for this XMLData object. |
| 1505 | Invalid XMLData kind was specified. |
| 1506 | Invalid address for the return parameter was specified. |
| 1507 | Element cannot have Children |
| 1512 | Cyclic insertion - new data element is already part of document |
| 1514 | Invalid XMLData kind was specified for this position. |
| 1900 | Document must not be modified |

26.3.2.30.19 InsertChildAfter

Method: InsertChildAfter (Node as XMLData, NewData as XMLData)

Description

Inserts a new XML node (supplied with the second parameter) after the specified node (first parameter).

Errors

| | |
|------|--------------------------|
| 1500 | Invalid object. |
| 1506 | Invalid input xml |
| 1507 | No children allowed |
| 1510 | Invalid parameter. |
| 1512 | Child is already added |
| 1514 | Invalid kind at position |

26.3.2.30.20 InsertChildBefore

Method: InsertChildBefore (Node as XMLData, NewData as XMLData)

Description

Inserts a new XML node (supplied with the second parameter) before the specified node (first parameter).

Errors

| | |
|------|--------------------------|
| 1500 | Invalid object. |
| 1506 | Invalid input xml |
| 1507 | No children allowed |
| 1510 | Invalid parameter. |
| 1512 | Child is already added |
| 1514 | Invalid kind at position |

26.3.2.30.21 IsSameNode

Declaration: IsSameNode (pNodeToCompare as [XMLData](#)¹³⁷³) as Boolean

Description

Returns true if pNodeToCompare references the same node as the object itself.

Errors

| | |
|------|---|
| 1500 | The XMLData object is no longer valid. |
| 1506 | Invalid address for the return parameter was specified. |

26.3.2.30.22 Kind

Declaration: Kind as [SPYXMLDataKind](#)¹⁴³⁵

Description

Kind of this XMLData object. This property is read-only.

Errors

| | |
|------|---|
| 1500 | The XMLData object is no longer valid. |
| 1510 | Invalid address for the return parameter was specified. |

26.3.2.30.23 MayHaveChildren

Declaration: MayHaveChildren as Boolean

Description

Indicates whether it is allowed to add children to this XMLData object. This property is read-only.

Errors

| | |
|------|---|
| 1500 | The XMLData object is no longer valid. |
| 1510 | Invalid address for the return parameter was specified. |

26.3.2.30.24 Name

Declaration: Name as String

Description

Used to modify and to get the name of the XMLData object.

Errors

| | |
|------|---|
| 1500 | The XMLData object is no longer valid. |
| 1510 | Invalid address for the return parameter was specified. |

26.3.2.30.25 Parent

Declaration: Parent as [XMLData](#) ¹³⁷³

Return value

Parent as XMLData object. Nothing (or NULL) if there is no parent element.

Description

Parent of this element. This property is read-only.

Errors

| | |
|------|---|
| 1500 | The XMLData object is no longer valid. |
| 1510 | Invalid address for the return parameter was specified. |

26.3.2.30.26 SetTextValueXMLEncoded

Method: SetTextValueXMLEncoded (*strVal* as [String](#) ¹⁴³⁵)

Description

Sets the encoded text value of the XML.

Errors

| | |
|------|---------------------------|
| 1500 | Invalid object. |
| 1513 | Modification not allowed. |

26.3.2.30.27 TextValue

Declaration: TextValue as String

Description

Used to modify and to get the text value of this XMLData object.

Errors

| | |
|------|---|
| 1500 | The XMLData object is no longer valid. |
| 1510 | Invalid address for the return parameter was specified. |

26.3.3 Interfaces (obsolete)

Interfaces contained in this book are obsolete. It is recommended to migrate your applications to the new interfaces. See the different properties and methods in this book for migration hints.

26.3.3.1 AuthenticEvent (obsolete)

Superseded by [AuthenticView](#)¹²²⁹ and [AuthenticRange](#)¹¹⁹⁹

The DocEditView object is renamed to OldAuthenticView.
 DocEditSelection is renamed to AuthenticSelection.
 DocEditEvent is renamed to AuthenticEvent.
 DocEditDataTransfer is renamed to AuthenticDataTransfer.

Their usage - except for AuthenticDataTransfer - is no longer recommended. We will continue to support existing functionality for a yet undefined period of time but no new features will be added to these interface. All functionality available up to now in [DocEditView](#)¹⁴⁰⁰, [DocEditSelection](#)¹³⁹⁸, [DocEditEvent](#)¹³⁸⁵ and [DocEditDataTransfer](#)¹¹⁹⁵ is now available via [AuthenticView](#)¹²²⁹, [AuthenticRange](#)¹¹⁹⁹ and [AuthenticDataTransfer](#)¹¹⁹⁴. Many new features have been added.

For examples on migrating from DocEdit to Authentic see the description of the different methods and properties of the different DocEdit objects.

Properties

- [altKey](#)¹³⁸⁶
- [altLeft](#)¹³⁸⁷
- [ctrlKey](#)¹³⁹¹

[ctrlLeft](#) ¹³⁹²[shiftKey](#) ¹³⁹⁵[shiftLeft](#) ¹³⁹⁶[keyCode](#) ¹³⁹³[repeat](#) ¹³⁹⁴[button](#) ¹³⁸⁸[clientX](#) ¹³⁸⁹[clientY](#) ¹³⁹⁰[dataTransfer](#) ¹³⁹²[srcElement](#) ¹³⁹⁶[fromElement](#) ¹³⁹³[propertyName](#) ¹³⁹⁴[cancelBubble](#) ¹³⁸⁹[returnValue](#) ¹³⁹⁵[type](#) ¹³⁹⁷**Description**

DocEditEvent interface.

26.3.3.1.1 altKey (obsolete)

Superseded by parameters to[AuthenticView.OnKeyboardEvent](#) ¹²³⁵ (On_AuthenticView_KeyPressed)[AuthenticView.OnMouseEvent](#) ¹²³⁶ (On_AuthenticView_MouseEvent)[AuthenticView.OnDragOver](#) ¹²³³ (On_AuthenticView_DragOver)

The event object that holds the information of the last event is now replaced by parameters to the different event handler functions to simplify data access. The event object will be supported for a not yet defined period of time for compatibility reasons. No improvements are planned. It is highly recommended to migrate to the new event handler functions.

```
// ---- XMLSpy scripting environment - javascript sample ----
// instead of:
// function On_DocEditKeyPressed ()
// {
//   if (Application.ActiveDocument.DocEditView.event.altKey ||
//       Application.ActiveDocument.DocEditView.event.altLeft)
//     MsgBox ("alt key is down");
```

```
//}
// use now:
function On_AuthenticView_KeyPressed (SPYKeyEvent i_eKeyEvent, long i_nKeyCode,
SPYVirtualKeyMask i_nVirtualKeyStatus)
{
    if (i_nVirtualKeyStatus & spyAltKeyMask)
        MsgBox ("alt key is down");
}
```

Declaration: altKey as Boolean

Description

True if the right ALT key is pressed.

26.3.3.1.2 altLeft (obsolete)

Superseded by parameters to
[AuthenticView.OnKeyboardEvent](#)¹²³⁵ (On_AuthenticView_KeyPressed)
[AuthenticView.OnMouseEvent](#)¹²³⁶ (On_AuthenticView_MouseEvent)
[AuthenticView.OnDragOver](#)¹²³³ (On_AuthenticView_DragOver)

The event object that holds the information of the last event is now replaced by parameters to the different event handler functions to simplify data access. The event object will be supported for a not yet defined period of time for compatibility reasons. No improvements are planned. It is highly recommended to migrate to the new event handler functions.

```
// ---- XMLSpy scripting environment - javascript sample ----
// instead of:
// function On_DocEditKeyDown ()
// {
//     if (Application.ActiveDocument.DocEditView.event.altKey ||
//         Application.ActiveDocument.DocEditView.event.altLeft)
//         MsgBox ("alt key is down");
// }
// use now:
function On_AuthenticView_KeyDown (SPYKeyEvent i_eKeyEvent, long i_nKeyCode, SPYVirtualKeyMask
i_nVirtualKeyStatus)
{
    if (i_nVirtualKeyStatus & spyAltKeyMask)
        MsgBox ("alt key is down");
}
```

Declaration: altLeft as Boolean

Description

True if the left ALT key is pressed.

26.3.3.1.3 button (obsolete)

Superseded by parameters to[AuthenticView.OnMouseEvent](#)¹²³⁶ (On_AuthenticView_MouseEvent)[AuthenticView.OnDragOver](#)¹²³³ (On_AuthenticView_DragOver)

The event object that holds the information of the last event is now replaced by parameters to the different event handler functions to simplify data access. The event object will be supported for a not yet defined period of time for compatibility reasons. No improvements are planned. It is highly recommended to migrate to the new event handler functions.

```
// ---- XMLSpy scripting environment - javascript sample ----
// instead of:
// function On_DocEditButtonDown ()
// {
//   if (Application.ActiveDocument.DocEditView.event.button == 1)
//     MsgBox ("left mouse button down detected");
// }
// use now:
function On_AuthenticView_MouseEvent (long i_nXPos, long i_nYPos, SPYMouseEvent i_eMouseEvent,
IAuthenticRange *i_ipRange)
{
  if (i_eMouseEvent & spyLeftButtonDownMask)
    MsgBox ("left mouse button down detected");
}
```

Declaration: button as long

Description

Specifies which mouse button is pressed:

| | |
|---|--|
| 0 | No button is pressed. |
| 1 | Left button is pressed. |
| 2 | Right button is pressed. |
| 3 | Left and right buttons are both pressed. |
| 4 | Middle button is pressed. |
| 5 | Left and middle buttons both are pressed. |
| 6 | Right and middle buttons are both pressed. |
| 7 | All three buttons are pressed. |

26.3.3.1.4 cancelBubble (obsolete)

Superseded by the boolean return value of following event handler functions

[AuthenticView.OnKeyboardEvent](#)¹²³⁵ (On_AuthenticView_KeyPressed)

[AuthenticView.OnMouseEvent](#)¹²³⁶ (On_AuthenticView_MouseEvent)

[AuthenticView.OnDragOver](#)¹²³³ (On_AuthenticView_DragOver)

The event object that holds the information of the last event is now replaced by parameters to the different event handler functions to simplify data access. The event object will be supported for a not yet defined period of time for compatibility reasons. No improvements are planned. It is highly recommended to migrate to the new event handler functions.

Returning *true* from an event handler function signals that the event has been handled and normal event handling should be aborted.

```
// ---- XMLSpy scripting environment - javascript sample ----
// instead of:
// function On_DocEditKeyPressed ()
// {
//   if (Application.ActiveDocument.DocEditView.event.keyCode == 0x20)
//   {
//     // cancel key processing, swallow spaces :-)
//     Application.ActiveDocument.DocEditView.event.cancelBubble = true;
//   }
// }
// use now:
function On_AuthenticView_KeyPressed (SPYKeyEvent i_eKeyEvent, long i_nKeyCode,
SPYVirtualKeyMask i_nVirtualKeyStatus)
{
  if (i_nKeyCode == 0x20)
    return true; // cancel key processing, swallow spaces :-)
}
```

Declaration: cancelBubble as Boolean

Description

Set cancelBubble to TRUE if the default event handler should not be called.

26.3.3.1.5 clientX (obsolete)

Superseded by parameters to

[AuthenticView.OnMouseEvent](#)¹²³⁶ (On_AuthenticView_MouseEvent)

[AuthenticView.OnBeforeDrop](#)¹²³² (On_AuthenticView_BeforeDrop)

[AuthenticView.OnDragOver](#)¹²³³ (On_AuthenticView_DragOver)

The event object that holds the information of the last event is now replaced by parameters to the different event handler functions to simplify data access. The event object will be supported for a not yet defined period of time for compatibility reasons. No improvements are planned. It is highly recommended to migrate to the new event handler functions.

```
// ---- XMLSpy scripting environment - javascript sample ----
// instead of:
// function On_DocEditMouseMove ()
// {
//     MsgBox ("moving over " + Application.ActiveDocument.DocEditView.event.clientX +
//           "/" + Application.ActiveDocument.DocEditView.event.clientY);
// }
// use now:
function On_AuthenticView_MouseEvent (long i_nXPos, long i_nYPos, SPYMouseEvent i_eMouseEvent,
IAuthenticRange *i_ipRange)
{
    if (i_eMouseEvent & spyMouseMoveMask)
        MsgBox ("moving over " + i_nXPos + "/" + i_nYPos);
}
```

Declaration: clientX as long

Description

X value of the current mouse position in client coordinates.

26.3.3.1.6 clientY (obsolete)

Superseded by parameters to
[AuthenticView.OnMouseEvent](#)¹²³⁶ (On_AuthenticView_MouseEvent)
[AuthenticView.OnBeforeDrop](#)¹²³² (On_AuthenticView_BeforeDrop)
[AuthenticView.OnDragOver](#)¹²³³ (On_AuthenticView_DragOver)

The event object that holds the information of the last event is now replaced by parameters to the different event handler functions to simplify data access. The event object will be supported for a not yet defined period of time for compatibility reasons. No improvements are planned. It is highly recommended to migrate to the new event handler functions.

```
// ---- XMLSpy scripting environment - javascript sample ----
// instead of:
// function On_DocEditMouseMove ()
// {
//     MsgBox ("moving over " + Application.ActiveDocument.DocEditView.event.clientX +
//           "/" + Application.ActiveDocument.DocEditView.event.clientY);
// }
// use now:
function On_AuthenticView_MouseEvent (long i_nXPos, long i_nYPos, SPYMouseEvent i_eMouseEvent,
IAuthenticRange *i_ipRange)
```

```
{
  if (i_eMouseEvent & spyMouseMoveMask)
    MsgBox ("moving over " + i_nXPos + "/" + i_nYPos);
}
```

Declaration: clientY as long

Description

Y value of the current mouse position in client coordinates.

26.3.3.1.7 ctrlKey (obsolete)

Superseded by parameters to
[AuthenticView.OnKeyboardEvent](#)¹²³⁵ (On_AuthenticView_KeyPressed)
[AuthenticView.OnMouseEvent](#)¹²³⁶ (On_AuthenticView_MouseEvent)
[AuthenticView.OnDragOver](#)¹²³³ (On_AuthenticView_DragOver)

The event object that holds the information of the last event is now replaced by parameters to the different event handler functions to simplify data access. The event object will be supported for a not yet defined period of time for compatibility reasons. No improvements are planned. It is highly recommended to migrate to the new event handler functions.

```
// ---- XMLSpy scripting environment - javascript sample ----
// instead of:
// function On_DocEditMouseMove ()
// {
//   if (Application.ActiveDocument.DocEditView.event.ctrlKey ||
//       Application.ActiveDocument.DocEditView.event.altLeft)
//     MsgBox ("control key is down");
// }
// use now:
function On_AuthenticView_MouseEvent (long i_nXPos, long i_nYPos, SPYMouseEvent i_eMouseEvent,
IAuthenticRange *i_ipRange)
{
  if (i_eMouseEvent & spyCtrlKeyMask)
    MsgBox ("control key is down");
}
```

Declaration: ctrlKey as Boolean

Description

True if the right CTRL key is pressed.

26.3.3.1.8 ctrlLeft (obsolete)

Superseded by parameters to[AuthenticView.OnKeyboardEvent](#)¹²³⁵ (On_AuthenticView_KeyPressed)[AuthenticView.OnMouseEvent](#)¹²³⁶ (On_AuthenticView_MouseEvent)[AuthenticView.OnDragOver](#)¹²³³ (On_AuthenticView_DragOver)

The event object that holds the information of the last event is now replaced by parameters to the different event handler functions to simplify data access. The event object will be supported for a not yet defined period of time for compatibility reasons. No improvements are planned. It is highly recommended to migrate to the new event handler functions.

```
// ---- XMLSpy scripting environment - javascript sample ----
// instead of:
// function On_DocEditMouseMove ()
// {
//   if (Application.ActiveDocument.DocEditView.event.ctrlKey ||
//       Application.ActiveDocument.DocEditView.event.altLeft)
//     MsgBox ("control key is down");
// }
// use now:
function On_AuthenticView_MouseEvent (long i_nXPos, long i_nYPos, SPYMouseEvent i_eMouseEvent,
IAuthenticRange *i_ipRange)
{
  if (i_eMouseEvent & spyCtrlKeyMask)
    MsgBox ("control key is down");
}
```

Declaration: ctrlLeft as Boolean

Description

True if the left CTRL key is pressed.

26.3.3.1.9 dataTransfer (obsolete)

Superseded by parameters to[AuthenticView.OnBeforeDrop](#)¹²³² (On_AuthenticView_BeforeDrop)[AuthenticView.OnDragOver](#)¹²³³ (On_AuthenticView_DragOver)

The event object that holds the information of the last event is now replaced by parameters to the different event handler functions to simplify data access. The event object will be supported for a not yet defined period of time for compatibility reasons. No improvements are planned. It is highly recommended to migrate to the new event handler functions.

```
// ---- XMLSpy scripting environment - javascript sample ----
// instead of:
```

```

// function On_DocEditDrop ()
// {
//   if (Application.ActiveDocument.DocEditView.event.dataTransfer != null)
//     if (! Application.ActiveDocument.DocEditView.event.dataTransfer.ownDrag)
//       {
//         // cancel key processing, don't drop foreign objects :-)
//         Application.ActiveDocument.DocEditView.event.cancelBubble = true;
//       }
// }
// use now:
function On_AuthenticView_BeforeDrop (long i_nXPos, long i_nYPos,
                                     IAuthenticRange *i_ipRange,
                                     IAuthenticDataTransfer *i_ipData)
{
  if (i_ipRange != null)
    if (! i_ipRange.ownDrag)
      return true; // cancel key processing, don't drop foreign objects :-)

  return false;
}

```

Declaration: dataTransfer as Variant

Description

Property dataTransfer.

26.3.3.1.10 fromElement (obsolete)

Not supported

Declaration: fromElement as Variant (not supported)

Description

Currently no event sets this property.

26.3.3.1.11 keyCode (obsolete)

Superseded by a parameter to [AuthenticView.OnKeyboardEvent](#)¹²³⁵ (On_AuthenticView_KeyPressed)

The event object that holds the information of the last event is now replaced by parameters to the different event handler functions to simplify data access. The event object will be supported for a not yet defined period

of time for compatibility reasons. No improvements are planned. It is highly recommended to migrate to the new event handler functions.

```
// ---- XMLSpy scripting environment - javascript sample ----  
// instead of:  
// function On_DocEditKeyPressed ()  
// {  
//   if (Application.ActiveDocument.DocEditView.event.keyCode == 0x20)  
//   {  
//     // cancel key processing, swallow spaces :-)  
//     Application.ActiveDocument.DocEditView.event.cancelBubble = true;  
//   }  
// }  
// use now:  
function On_AuthenticView_KeyPressed (SPYKeyEvent i_eKeyEvent, long i_nKeyCode,  
SPYVirtualKeyMask i_nVirtualKeyStatus)  
{  
  if (i_nKeyCode == 0x20)  
    return true; // cancel key processing, swallow spaces :-)  
}
```

Declaration: keyCode as long

Description

Keycode of the currently pressed key. This property is read-write.

26.3.3.1.12 propertyName (obsolete)

Not supported

Declaration: propertyName as String (not supported)

Description

Currently no event sets this property.

26.3.3.1.13 repeat (obsolete)

Not supported

Declaration: repeat as Boolean (not supported)

Description

True if the onkeydown event is repeated.

26.3.3.1.14 returnValue (obsolete)

No longer supported

Declaration: returnValue as Variant

Description

Use returnValue to set a return value for your event handler.

26.3.3.1.15 shiftKey (obsolete)

Superseded by parameters to
[AuthenticView.OnKeyboardEvent](#)¹²³⁵ (On_AuthenticView_KeyPressed)
[AuthenticView.OnMouseEvent](#)¹²³⁶ (On_AuthenticView_MouseEvent)
[AuthenticView.OnDragOver](#)¹²³³ (On_AuthenticView_DragOver)

The event object that holds the information of the last event is now replaced by parameters to the different event handler functions to simplify data access. The event object will be supported for a not yet defined period of time for compatibility reasons. No improvements are planned. It is highly recommended to migrate to the new event handler functions.

```
// ---- XMLSpy scripting environment - javascript sample ----
// instead of:
// function On_DocEditDragOver ()
// {
//   if (Application.ActiveDocument.DocEditView.event.shiftKey ||
//       Application.ActiveDocument.DocEditView.event.shiftLeft)
//     MsgBox ("shift key is down");
// }
// use now:
function On_AuthenticView_DragOver (long i_nXPos, long i_nYPos,
                                   SPYMouseEvent i_eMouseEvent,
                                   IAuthenticRange *i_ipRange,
                                   IAuthenticDataTransfer *i_ipData)
{
  if (i_eMouseEvent & spyShiftKeyMask)
    MsgBox ("shift key is down");
}
```

Declaration: shiftKey as Boolean

Description

True if the right SHIFT key is pressed.

26.3.3.1.16 shiftLeft (obsolete)

Superseded by parameters to

[AuthenticView.OnKeyboardEvent](#)¹²³⁵ (On_AuthenticView_KeyPressed)

[AuthenticView.OnMouseEvent](#)¹²³⁶ (On_AuthenticView_MouseEvent)

[AuthenticView.OnDragOver](#)¹²³³ (On_AuthenticView_DragOver)

The event object that holds the information of the last event is now replaced by parameters to the different event handler functions to simplify data access. The event object will be supported for a not yet defined period of time for compatibility reasons. No improvements are planned. It is highly recommended to migrate to the new event handler functions.

```
// ---- XMLSpy scripting environment - javascript sample ----
// instead of:
// function On_DocEditDragOver ()
// {
//   if (Application.ActiveDocument.DocEditView.event.shiftKey ||
//       Application.ActiveDocument.DocEditView.event.shiftLeft)
//     MsgBox ("shift key is down");
// }
// use now:
function On_AuthenticView_DragOver (long i_nXPos, long i_nYPos,
                                   SPYMouseEvent i_eMouseEvent,
                                   IAuthenticRange *i_ipRange,
                                   IAuthenticDataTransfer *i_ipData)
{
  if (i_eMouseEvent & spyShiftKeyMask)
    MsgBox ("shift key is down");
}
```

Declaration: shiftLeft as Boolean

Description

True if the left SHIFT key is pressed.

26.3.3.1.17 srcElement (obsolete)

Superseded by parameters to

[AuthenticView.OnMouseEvent](#)¹²³⁶ (On_AuthenticView_MouseEvent)

[AuthenticView.OnBeforeDrop](#)¹²³² (On_AuthenticView_BeforeDrop)

AuthenticView.OnDragOver¹²³³ (On_AuthenticView_DragOver)

The event object that holds the information of the last event is now replaced by parameters to the different event handler functions to simplify data access. The event object will be supported for a not yet defined period of time for compatibility reasons. No improvements are planned. It is highly recommended to migrate to the new event handler functions.

With the new event handler function, a range object selecting this element is provided instead of the XMLData element currently below the mouse cursor.

```
// ---- XMLSpy scripting environment - javascript sample ----
// instead of:
// function On_DocEditMouseMove ()
// {
//   var objEvent = Application.ActiveDocument.DocEditView.event;
//   if (objEvent.srcElement != null)
//     MsgBox ("moving over " + objEvent.srcElement.Parent.Name);
// }
// use now:
function On_AuthenticView_MouseEvent (long i_nXPos, long i_nYPos, SPYMouseEvent i_eMouseEvent,
IAuthenticRange *i_ipRange)
{
  if ((i_eMouseEvent & spyMouseMoveMask) &&
      (i_ipRange != null))
    MsgBox ("moving over " + i_ipRange.FirstXMLData.Parent.Name);
}
```

Declaration: srcElement as Variant

Description

Element which fires the current event. This is usually an [XMLData](#)¹³⁷³ object.

26.3.3.1.18 type (obsolete)

Not supported

Declaration: type as String (not supported)

Description

Currently no event sets this property.

26.3.3.2 AuthenticSelection (obsolete)

Superseded by [AuthenticRange](#)¹¹⁹⁹

The DocEditView object is renamed to OldAuthenticView.
 DocEditSelection is renamed to AuthenticSelection.
 DocEditEvent is renamed to AuthenticEvent.
 DocEditDataTransfer is renamed to AuthenticDataTransfer.

Their usage - except for AuthenticDataTransfer - is no longer recommended. We will continue to support existing functionality for a yet undefined period of time but no new features will be added to these interface. All functionality available up to now in [DocEditView](#)¹⁴⁰⁰, [DocEditSelection](#)¹³⁹⁸, [DocEditEvent](#)¹³⁸⁵ and [DocEditDataTransfer](#)¹¹⁹⁴ is now available via [AuthenticView](#)¹²²⁹, [AuthenticRange](#)¹¹⁹⁹ and [AuthenticDataTransfer](#)¹¹⁹⁴. Many new features have been added.

For examples on migrating from DocEdit to Authentic see the description of the different methods and properties of the different DocEdit objects.

Properties

[Start](#)¹³⁹⁹

[StartTextPosition](#)¹³⁹⁹

[End](#)¹³⁹⁸

[EndTextPosition](#)¹³⁹⁹

26.3.3.2.1 End (obsolete)

Superseded by [AuthenticRange.LastXMLData](#)¹²²⁰

```
// ---- javascript sample ----
// instead of:
// var objXMLData = Application.ActiveDocument.DocEditView.CurrentSelection.End;
// use now:
var objXMLData = Application.ActiveDocument.AuthenticView.Selection.LastXMLData;
```

Declaration: End as [XMLData](#)¹³⁷³

Description

XML element where the current selection ends.

26.3.3.2.2 EndTextPosition (obsolete)

Superseded by [AuthenticRange.LastXMLDataOffset](#) ¹²²¹

```
// ---- javascript sample ----  
// instead of:  
// var nOffset = Application.ActiveDocument.DocEditView.CurrentSelection.EndTextPosition;  
// use now:  
var nOffset = Application.ActiveDocument.AuthenticView.Selection.LastXMLDataOffset;
```

Declaration: EndTextPosition as long

Description

Position in [DocEditSelection.End.TextValue](#) ¹³⁹⁸ where the selection ends.

26.3.3.2.3 Start (obsolete)

Superseded by [AuthenticRange.FirstXMLData](#) ¹²⁰⁷

```
// ---- javascript sample ----  
// instead of:  
// var objXMLData = Application.ActiveDocument.DocEditView.CurrentSelection.Start;  
// use now:  
var objXMLData = Application.ActiveDocument.AuthenticView.Selection.FirstXMLData;
```

Declaration: Start as [XMLData](#) ¹³⁷³

Description

XML element where the current selection starts.

26.3.3.2.4 StartTextPosition (obsolete)

Superseded by [AuthenticRange.FirstXMLDataOffset](#) ¹²⁰⁸

```
// ---- javascript sample ----  
// instead of:  
// var nOffset = Application.ActiveDocument.DocEditView.CurrentSelection.StartTextPosition;  
// use now:  
var nOffset = Application.ActiveDocument.AuthenticView.Selection.FirstXMLDataOffset;
```

Declaration: StartTextPosition as long

Description

Position in [DocEditSelection.Start.TextValue](#) ¹³⁹⁹ where the selection starts.

26.3.3.3 OldAuthenticView (obsolete)

Superseded by [AuthenticView](#)¹²²⁹ and [AuthenticRange](#)¹¹⁹⁹

The DocEditView object is renamed to OldAuthenticView.
DocEditSelection is renamed to AuthenticSelection.
DocEditEvent is renamed to AuthenticEvent.
DocEditDataTransfer is renamed to AuthenticDataTransfer.

Their usage - except for AuthenticDataTransfer - is no longer recommended. We will continue to support existing functionality for a yet undefined period of time but no new features will be added to these interfaces. All functionality available up to now in [DocEditView](#)¹⁴⁰⁰, [DocEditSelection](#)¹³⁹⁸, [DocEditEvent](#)¹³⁸⁵ and [DocEditDataTransfer](#)¹¹⁹⁵ is now available via [AuthenticView](#)¹²²⁹, [AuthenticRange](#)¹¹⁹⁹ and [AuthenticDataTransfer](#)¹¹⁹⁴. Many new features have been added.

For examples on migrating from DocEdit to Authentic see the description of the different methods and properties of the different DocEdit objects.

Methods

[LoadXML](#)¹⁴¹⁶

[SaveXML](#)¹⁴²⁰

[EditClear](#)¹⁴⁰²

[EditCopy](#)¹⁴⁰³

[EditCut](#)¹⁴⁰³

[EditPaste](#)¹⁴⁰⁴

[EditRedo](#)¹⁴⁰⁴

[EditSelectAll](#)¹⁴⁰⁵

[EditUndo](#)¹⁴⁰⁵

[RowAppend](#)¹⁴¹⁷

[RowDelete](#)¹⁴¹⁷

[RowDuplicate](#)¹⁴¹⁸

[RowInsert](#)¹⁴¹⁸

[RowMoveDown](#)¹⁴¹⁹

[RowMoveUp](#)¹⁴¹⁹

[ApplyTextState](#)¹⁴⁰¹

[IsTextStateApplied](#)¹⁴¹⁵

[IsTextStateEnabled](#)¹⁴¹⁵

[MarkupView](#)¹⁴¹⁶

[SelectionSet](#)¹⁴²¹

[SelectionMoveTabOrder](#)¹⁴²¹

[GetNextVisible](#) ¹⁴⁰⁸[GetPreviousVisible](#) ¹⁴⁰⁸[GetAllowedElements](#) ¹⁴⁰⁶

Properties

[CurrentSelection](#) ¹⁴⁰²[event](#) ¹⁴⁰⁵[XMLRoot](#) ¹⁴²²[IsEditClearEnabled](#) ¹⁴⁰⁹[IsEditCopyEnabled](#) ¹⁴¹⁰[IsEditCutEnabled](#) ¹⁴¹⁰[IsEditPasteEnabled](#) ¹⁴¹¹[IsEditRedoEnabled](#) ¹⁴¹¹[IsEditUndoEnabled](#) ¹⁴¹²[IsRowAppendEnabled](#) ¹⁴¹²[IsRowDeleteEnabled](#) ¹⁴¹³[IsRowDuplicateEnabled](#) ¹⁴¹³[IsRowInsertEnabled](#) ¹⁴¹⁴[IsRowMoveDownEnabled](#) ¹⁴¹⁴[IsRowMoveUpEnabled](#) ¹⁴¹⁴

Description

Interface for Authentic View.

26.3.3.3.1 ApplyTextState (obsolete)

Superseded by [AuthenticRange.PerformAction](#) ¹²²³

Use `spyAuthenticApply` for the `eAction` parameter. The `PerformAction` method allows to apply text state attributes to any range of the document, not only the current UI selection.

```
// ---- javascript sample ----
```

```
// instead of:
```

```
// Application.ActiveDocument.DocEditView.ApplyTextState ("bold");
```

```
// use now:
```

```
if (! Application.ActiveDocument.AuthenticView.Selection.PerformAction (spyAuthenticApply, "bold"))  
    MsgBox ("Error: can't set current selection to bold");
```

Declaration: `ApplyTextState (elementName as String)`

Description

Applies or removes the text state defined by the parameter `elementName`. Common examples for the parameter `elementName` would be `strong` and `italic`.

In an XML document there are segments of data, which may contain sub-elements. For example consider the following HTML:

```
<b>fragment</b>
```

The HTML tag `` will cause the word `fragment` to be bold. However, this only happens because the HTML parser knows that the tag `` is bold. With XML there is much more flexibility. It is possible to define any XML tag to do anything you desire. The point is that it is possible to apply a Text state using XML. But the Text state that is applied must be part of the schema. For example in the `OrgChart.xml`, `OrgChart.sps`, `OrgChart.xsd` example the tag `` is the same as bold. And to apply bold the method `ApplyTextState()` is called. But like the row and edit operations it is necessary to test if it is possible to apply the text state.

See also [IsTextStateEnabled](#)¹⁴¹⁵ and [IsTextStateApplied](#)¹⁴¹⁵.

26.3.3.3.2 CurrentSelection (obsolete)

Superseded by [AuthenticView.Selection](#)¹²⁴⁶

The returned [AuthenticRange](#)¹¹⁹⁹ object supports navigation via `XMLData` elements as well as navigation by document elements (e.g. characters, words, tags) or text cursor positions.

```
// ---- javascript sample ----
// instead of:
// var objDocEditSel = Application.ActiveDocument.DocEditView.CurrentSelection;
// use now:
var objRange = Application.ActiveDocument.AuthenticView.Selection;
```

Declaration: `CurrentSelection` as [DocEditSelection](#)¹³⁹⁸

Description

The property provides access to the current selection in the Authentic View.

26.3.3.3.3 EditClear (obsolete)

Superseded by [AuthenticRange.Delete](#)¹²⁰⁴

The `Delete` method of `AuthenticRange` allows to delete any range of the document, not only the current UI selection.

```
// ---- javascript sample ----
```

```
// instead of:  
// Application.ActiveDocument.DocEditView.EditClear();  
// use now:  
if (! Application.ActiveDocument.AuthenticView.Selection.Delete())  
    MsgBox ("Error: can't delete current selection");
```

Declaration: EditClear

Description

Deletes the current selection.

26.3.3.3.4 EditCopy (obsolete)

Superseded by [AuthenticRange.Copy](#)¹²⁰⁴

The Copy method of AuthenticRange allows to delete any range of the document, not only the current UI selection.

```
// ---- javascript sample ----  
// instead of:  
// Application.ActiveDocument.DocEditView.EditCopy();  
// use now:  
if (! Application.ActiveDocument.AuthenticView.Selection.Copy())  
    MsgBox ("Error: can't copy current selection");
```

Declaration: EditCopy

Description

Copies the current selection to the clipboard.

26.3.3.3.5 EditCut (obsolete)

Superseded by [AuthenticRange.Cut](#)¹²⁰⁴

The Cut method of AuthenticRange allows to delete any range of the document, not only the current UI selection.

```
// ---- javascript sample ----  
// instead of:  
// Application.ActiveDocument.DocEditView.EditCut();  
// use now:
```

```
if (! Application.ActiveDocument.AuthenticView.Selection.Cut())
    MsgBox ("Error: can't cut out current selection");
```

Declaration: EditCut

Description

Cuts the current selection from the document and copies it to the clipboard.

26.3.3.3.6 EditPaste (obsolete)

Superseded by [AuthenticRange.Paste](#) ¹²²³

The Paste method of AuthenticRange allows to delete any range of the document, not only the current UI selection.

```
// ---- javascript sample ----
// instead of:
// Application.ActiveDocument.DocEditView.EditPaste();
// use now:
if (! Application.ActiveDocument.AuthenticView.Selection.Paste())
    MsgBox ("Error: can't paste to current selection");
```

Declaration: EditPaste

Description

Pastes the content from the clipboard into the document.

26.3.3.3.7 EditRedo (obsolete)

Superseded by [AuthenticView.Redo](#) ¹²⁴⁶

```
// ---- javascript sample ----
// instead of:
// Application.ActiveDocument.DocEditView.EditRedo();
// use now:
if (! Application.ActiveDocument.AuthenticView.Redo())
    MsgBox ("Error: no redo step available");
```

Declaration: EditRedo

Description

Redo the last undo step.

26.3.3.3.8 EditSelectAll (obsolete)

Superseded by [AuthenticView.WholeDocument](#)¹²⁴⁶ and [AuthenticRange.Select](#)¹²²⁵

```
// ---- javascript sample ----  
// instead of:  
// Application.ActiveDocument.DocEditView.EditSelectAll();  
// use now:  
Application.ActiveDocument.AuthenticView.WholeDocument.Select();
```

Declaration: EditSelectAll

Description

The method selects the complete document.

26.3.3.3.9 EditUndo (obsolete)

Superseded by [AuthenticView.Undo](#)¹²⁴⁷

```
// ---- javascript sample ----  
// instead of:  
// Application.ActiveDocument.DocEditView.EditUndo();  
// use now:  
if (! Application.ActiveDocument.AuthenticView.Undo())  
    MsgBox ("Error: no undo step available");
```

Declaration: EditUndo

Description

Undo the last action.

26.3.3.3.10 event (obsolete)

Superseded by parameters to [AuthenticView events](#)¹²²⁹.

Declaration: event as [DocEditEvent](#)¹³⁸⁵

Description

The event property holds a DocEditEvent object which contains information about the current event.

26.3.3.3.11 GetAllowedElements (obsolete)

Superseded by [AuthenticRange.CanPerformActionWith](#)¹²⁰²

AuthenticRange now supports all functionality of the 'elements' entry helper. Besides querying the elements that can be inserted, appended, etc., you can invoke the action as well. See [AuthenticRange.PerformAction](#)¹²²⁴ for more information.

```
// ---- javascript sample ----
// instead of:
// var arrElements = New Array();
// var objDocEditView = Application.ActiveDocument.DocEditView;
// var objStartElement = objDocEditView.CurrentSelection.Start;
// var objEndElement = objDocEditView.CurrentSelection.End;
// objDocEditView.GetAllowedElements(k_ActionInsertBefore, objStartElement, objEndElement,
arrElements);
// use now:
var arrElements = New Array();
Application.ActiveDocument.AuthenticView.Selection.CanPerformActionWith (spyAuthenticInsertBefore,
arrElements);
```

Declaration: GetAllowedElements (*nAction* as [SpyAuthenticElementActions](#)¹⁴²³, *pStartElement* as [XMLData](#)¹³⁷³, *pEndElement* as [XMLData](#)¹³⁷³, *pElements* as Variant)

Description

GetAllowedElements() returns the allowed elements for the various actions specified by nAction.

JavaScript example:

```
Function GetAllowed()
{
    var objView = Application.ActiveDocument.DocEditView;

    var arrElements = New Array(1);

    var objStart = objView.CurrentSelection.Start;
    var objEnd = objView.CurrentSelection.End;

    var strText;
    strText = "valid elements at current selection:\n\n";

    For(var i = 1; i <= 4; i++) {
```

```
        objPlugIn.GetAllowedElements(i,objStart,objEnd,arrElements);
        strText = strText + ListArray(arrElements) + "-----\n";
    }

    Return strText;
}

Function ListArray(arrIn)
{
    var strText = "";

    If(.TypeOf(arrIn) == "object")    {
        For(var i = 0;i <= (arrIn.length - 1);i++)
            strText = strText + arrIn[i] + "\n";
    }

    Return strText;
}
```

VBScript example:

```
Sub DisplayAllowed
    Dim objView
    Set objView = Application.ActiveDocument.DocEditView

    Dim arrElements()

    Dim objStart
    Dim objEnd
    Set objStart = objView.CurrentSelection.Start
    Set objEnd = objView.CurrentSelection.End

    Dim strText
    strText = "valid elements at current selection:" & chr(13) & chr(13)

    Dim i

    For i = 1 To 4
        objView.GetAllowedElements i,objStart,objEnd,arrElements
        strText = strText & ListArray(arrElements) & "-----" & chr(13)
    Next

    msgbox strText
End Sub

Function ListArray(arrIn)
    Dim strText

    If IsArray(arrIn) Then
        Dim i

        For i = 0 To UBound(arrIn)
            strText = strText & arrIn(i) & chr(13)
        Next
    End If
End Function
```

```

        Next
    End If

    ListArray = strText
End Function

```

26.3.3.3.12 GetNextVisible (obsolete)

Superseded by [AuthenticRange.SelectNext](#)¹²²⁵

AuthenticRange now supports a wide range of element navigation methods based on document elements like characters, words, tags and many more. Selecting the text passage that represents the content of the next XML element is just one of them.

```

// ---- javascript sample ----
// instead of:
// var objCurrXMLData = ...
// var objXMLData = Application.ActiveDocument.DocEditView.GetNextVisible(objCurrXMLData);
// Application.ActiveDocument.DocEditView.SelectionSet (objXMLData, 0, objXMLData, -1);
// use now:
var objRange = ...
try
    { objRange.SelectNext (spyAuthenticTag).Select(); }
catch (err)
{
    if ((err.number & 0xffff) == 2003)
        MsgBox ("end of document reached");
    else
        throw (err);
}

```

Declaration: GetNextVisible (*pElement* as [XMLData](#)¹³⁷³) as [XMLData](#)¹³⁷³

Description

The method gets the next visible XML element in the document.

26.3.3.3.13 GetPreviousVisible (obsolete)

Superseded by [AuthenticRange.SelectPrevious](#)¹²²⁶

AuthenticRange now supports a wide range of element navigation methods based on document elements like characters, words, tags and many more. Selecting the text passage that represents the content of the previous XML element is just one of them.

```
// ---- javascript sample ----
// instead of:
// var objCurrXMLData = ...
// var objXMLData = Application.ActiveDocument.DocEditView.GetPreviousVisible(objCurrXMLData);
// Application.ActiveDocument.DocEditView.SelectionSet (objXMLData, 0, objXMLData, -1);
// use now:
var objRange = ...
try
  { objRange.SelectPrevious (spyAuthenticTag).Select(); }
catch (err)
{
  if ((err.number & 0xffff) == 2004)
    MsgBox ("begin of document reached");
  else
    throw (err);
}
```

Declaration: GetPreviousVisible (*pElement* as [XMLData](#)¹³⁷³) as [XMLData](#)¹³⁷³

Description

The method gets the previous visible XML element in the document.

26.3.3.3.14 IsEditClearEnabled (obsolete)

Superseded by [AuthenticRange.IsDeleteEnabled](#)¹²¹⁷

The IsDeleteEnabled property is now supported for any range of the document, not only the current UI selection.

```
// ---- javascript sample ----
// instead of:
// if (Application.ActiveDocument.DocEditView.IsEditClearEnabled)
//   Application.ActiveDocument.DocEditView.EditClear();
// use now:
var objCurrSelection = Application.ActiveDocument.AuthenticView.Selection;
if (objCurrSelection.IsDeleteEnabled)
  objCurrSelection.Delete();
```

Declaration: IsEditClearEnabled as Boolean

Description

True if [EditClear](#)¹⁴⁰² is possible. See also [Editing operations](#)¹¹⁷⁰.

26.3.3.3.15 IsEditCopyEnabled (obsolete)

Superseded by [AuthenticRange.IsCopyEnabled](#)¹²¹⁶

The IsCopyEnabled property is now supported for any range of the document, not only the current UI selection.

```
// ---- javascript sample ----  
// instead of:  
// if (Application.ActiveDocument.DocEditView.IsEditCopyEnabled)  
//   Application.ActiveDocument.DocEditView.EditCopy();  
// use now:  
var objCurrSelection = Application.ActiveDocument.AuthenticView.Selection;  
if (objCurrSelection.IsCopyEnabled)  
  objCurrSelection.Copy();
```

Declaration: IsEditCopyEnabled as Boolean

Description

True if copy to clipboard is possible. See also [EditCopy](#)¹⁴⁰³ and [Editing operations](#)¹¹⁷⁰.

26.3.3.3.16 IsEditCutEnabled (obsolete)

Superseded by [AuthenticRange.IsCutEnabled](#)¹²¹⁷

The IsCutEnabled property is now supported for any range of the document, not only the current UI selection.

```
// ---- javascript sample ----  
// instead of:  
// if (Application.ActiveDocument.DocEditView.IsEditCutEnabled)  
//   Application.ActiveDocument.DocEditView.EditCut();  
// use now:  
var objCurrSelection = Application.ActiveDocument.AuthenticView.Selection;  
if (objCurrSelection.IsCutEnabled)  
  objCurrSelection.Cut();
```

Declaration: IsEditCutEnabled as Boolean

Description

True if [EditCut](#)¹⁴⁰³ is currently possible. See also [Editing operations](#)¹¹⁷⁰.

26.3.3.3.17 IsEditPasteEnabled (obsolete)

Superseded by [AuthenticRange.IsPasteEnabled](#) ¹²¹⁸

The IsPasteEnabled property is now supported for any range of the document, not only the current UI selection.

```
// ---- javascript sample ----  
// instead of:  
// if (Application.ActiveDocument.DocEditView.IsEditPasteEnabled)  
//   Application.ActiveDocument.DocEditView.EditPaste();  
// use now:  
var objCurrSelection = Application.ActiveDocument.AuthenticView.Selection;  
if (objCurrSelection.IsPasteEnabled)  
  objCurrSelection.Paste();
```

Declaration: IsEditPasteEnabled as Boolean

Description

True if [EditPaste](#) ¹⁴⁰⁴ is possible. See also [Editing operations](#) ¹¹⁷⁰.

26.3.3.3.18 IsEditRedoEnabled (obsolete)

Superseded by [AuthenticView.IsRedoEnabled](#) ¹²⁴⁴

```
// ---- javascript sample ----  
// instead of:  
// if (Application.ActiveDocument.DocEditView.IsEditRedoEnabled)  
//   Application.ActiveDocument.DocEditView.EditRedo();  
// use now:  
if (Application.ActiveDocument.AuthenticView.IsRedoEnabled)  
  Application.ActiveDocument.AuthenticView.Redo();
```

Declaration: IsEditRedoEnabled as Boolean

Description

True if [EditRedo](#) ¹⁴⁰⁴ is currently possible. See also [Editing operations](#) ¹¹⁷⁰.

26.3.3.3.19 IsEditUndoEnabled (obsolete)

Superseded by [AuthenticView.IsUndoEnabled](#) ¹²⁴⁴

```
// ---- javascript sample ----
// instead of:
// if (Application.ActiveDocument.DocEditView.IsEditUndoEnabled)
//   Application.ActiveDocument.DocEditView.EditUndo();
// use now:
if (Application.ActiveDocument.AuthenticView.IsUndoEnabled)
  Application.ActiveDocument.AuthenticView.Undo();
```

Declaration: IsEditUndoEnabled as Boolean

Description

True if [EditUndo](#) ¹⁴⁰⁵ is possible. See also [Editing operations](#) ¹¹⁷⁰.

26.3.3.3.20 IsRowAppendEnabled (obsolete)

Superseded by [AuthenticRange.IsInDynamicTable](#) ¹²¹⁸

The operations 'insert', 'append', 'delete' and 'duplicate' row are available whenever the selection is inside a dynamic table.

```
// ---- javascript sample ----
// instead of:
// if (Application.ActiveDocument.DocEditView.IsRowAppendEnabled)
//   Application.ActiveDocument.DocEditView.RowAppend();
// use now:
if (Application.ActiveDocument.AuthenticView.Selection.IsInDynamicTable())
  Application.ActiveDocument.AuthenticView.Selection.AppendRow();
```

Declaration: IsRowAppendEnabled as Boolean

Description

True if [RowAppend](#) ¹⁴¹⁷ is possible. See also [Row operations](#) ¹¹⁷⁰.

26.3.3.3.21 IsRowDeleteEnabled (obsolete)

Superseded by [AuthenticRange.IsInDynamicTable](#) ¹²¹⁸

The operations 'insert', 'append', 'delete' and 'duplicate' row are available whenever the selection is inside a dynamic table.

```
// ---- javascript sample ----  
// instead of:  
// if (Application.ActiveDocument.DocEditView.IsRowDeleteEnabled)  
//   Application.ActiveDocument.DocEditView.Rowdelete();  
// use now:  
if (Application.ActiveDocument.AuthenticView.Selection.IsInDynamicTable())  
  Application.ActiveDocument.AuthenticView.Selection.DeleteRow();
```

Declaration: IsRowDeleteEnabled as Boolean

Description

True if [RowDelete](#) ¹⁴¹⁷ is possible. See also [Row operations](#) ¹¹⁷⁰.

26.3.3.3.22 IsRowDuplicateEnabled (obsolete)

Superseded by [AuthenticRange.IsInDynamicTable](#) ¹²¹⁸

The operations 'insert', 'append', 'delete' and 'duplicate' row are available whenever the selection is inside a dynamic table.

```
// ---- javascript sample ----  
// instead of:  
// if (Application.ActiveDocument.DocEditView.IsRowDuplicateEnabled)  
//   Application.ActiveDocument.DocEditView.RowDuplicate();  
// use now:  
if (Application.ActiveDocument.AuthenticView.Selection.IsInDynamicTable())  
  Application.ActiveDocument.AuthenticView.Selection.DuplicateRow();
```

Declaration: IsRowDuplicateEnabled as Boolean

Description

True if [RowDuplicate](#) ¹⁴¹⁸ is currently possible. See also [Row operations](#) ¹¹⁷⁰.

26.3.3.3.23 `IsRowInsertEnabled` (obsolete)

Superseded by [AuthenticRange.IsInDynamicTable](#) ¹²¹⁸

The operations 'insert', 'append', 'delete' and 'duplicate' row are available whenever the selection is inside a dynamic table.

```
// ---- javascript sample ----
// instead of:
// if (Application.ActiveDocument.DocEditView.IsRowInsertEnabled)
//   Application.ActiveDocument.DocEditView.RowInsert();
// use now:
if (Application.ActiveDocument.AuthenticView.Selection.IsInDynamicTable())
  Application.ActiveDocument.AuthenticView.Selection.InsertRow();
```

Declaration: `IsRowInsertEnabled` as Boolean

Description

True if [RowInsert](#) ¹⁴¹⁸ is possible. See also [Row operations](#) ¹¹⁷⁰.

26.3.3.3.24 `IsRowMoveDownEnabled` (obsolete)

Superseded by [AuthenticRange.IsLastRow](#) ¹²¹⁸

```
// ---- javascript sample ----
// instead of:
// if (Application.ActiveDocument.OldAuthenticView.IsRowMoveDownEnabled)
//   Application.ActiveDocument.DocEditView.RowMoveDown();
// use now:
if (!Application.ActiveDocument.AuthenticView.Selection.IsLastRow)
  Application.ActiveDocument.AuthenticView.Selection.MoveRowDown();
```

Declaration: `IsRowMoveDownEnabled` as Boolean

Description

True if [RowMoveDown](#) ¹⁴¹⁹ is currently possible. See also [Row operations](#) ¹¹⁷⁰.

26.3.3.3.25 `IsRowMoveUpEnabled` (obsolete)

Superseded by [AuthenticRange.IsFirstRow](#) ¹²¹⁸

```
// ---- javascript sample ----
// instead of:
// if (Application.ActiveDocument.DocEditView.IsRowMoveUpEnabled)
//   Application.ActiveDocument.DocEditView.RowMoveUp();
// use now:
if (!Application.ActiveDocument.AuthenticView.Selection.IsFirstRow)
  Application.ActiveDocument.AuthenticView.Selection.MoveRowUp();
```

Declaration: IsRowMoveUpEnabled as Boolean

Description

True if [RowMoveUp](#)¹⁴¹⁹ is possible. See also [Row operations](#)¹¹⁷⁰.

26.3.3.3.26 IsTextStateApplied (obsolete)

Superseded by [AuthenticRange.IsTextStateApplied](#)¹²¹⁹

```
// ---- javascript sample ----
// instead of:
// Application.ActiveDocument.DocEditView.IsTextStateApplied ("bold");
// use now:
if (Application.ActiveDocument.AuthenticView.Selection.IsTextStateApplied ("bold"))
  MsgBox ("bold on");
else
  MsgBox ("bold off");
```

Declaration: IsTextStateApplied (*elementName* as String) as Boolean

Description

Checks to see if the it the text state has already been applied. Common examples for the parameter *elementName* would be strong and italic.

26.3.3.3.27 IsTextStateEnabled (obsolete)

Superseded by [AuthenticRange.CanPerformAction](#)¹²⁰²

Use spyAuthenticApply for the eAction parameter. The CanPerformAction method allows to operate on any range of the document, not only the current UI selection.

```
// ---- javascript sample ----
```

```
// instead of:
// Application.ActiveDocument.DocEditView.IsTextStateEnabled ("bold");
// use now:
if (Application.ActiveDocument.AuthenticView.Selection.CanPerformAction (spyAuthenticApply, "bold"))
    ... // e.g. enable 'bold' button
```

Declaration: IsTextStateEnabled (*i_strElementName* as String) as Boolean

Description

Checks to see if it is possible to apply a text state. Common examples for the parameter elementName would be strong and italic.

26.3.3.3.28 LoadXML (obsolete)

Superseded by [AuthenticView.AsXMLString](#) ¹²³⁹

AuthenticView now supports the property AsXMLString that can be used to directly access and replace the document content as an XMLString.

```
// ---- javascript sample ----
// instead of:
// Application.ActiveDocument.DocEditView.LoadXML (strDocAsXMLString);
// use now:
try
    { Application.ActiveDocument.AuthenticView.AsXMLString = strDocAsXMLString; }
catch (err)
    { MsgBox ("Error: invalid XML string"); }
```

Declaration: LoadXML (*xmlString* as String)

Description

Loads the current XML document with the XML string applied. The new content is displayed immediately. The *xmlString* parameter must begin with the XML declaration, e.g.,
objPlugIn.LoadXML("<?xml version='1.0' encoding='UTF-8'?><root></root>");

26.3.3.3.29 MarkupView (obsolete)

Superseded by [AuthenticView.MarkupVisibility](#) ¹²⁴⁵

```
// ---- javascript sample ----
// instead of:
// Application.ActiveDocument.DocEditView.MarkuUpView = 2;
```

```
// use now:
Application.ActiveDocument.AuthenticView.MarkupVisibility = spyAuthenticMarkupLarge;
```

Declaration: MarkUpView (*kind* as long)

Description

By default the document displayed is using HTML techniques. But sometimes it is desirable to show the editing tags. Using this method it is possible to display three different types of markup tags:

| | |
|---|-----------------------------|
| 0 | hide the markup tags |
| 2 | show the large markup tags |
| 3 | show the mixed markup tags. |

26.3.3.3.30 RowAppend (obsolete)

Superseded by [AuthenticRange.AppendRow](#) ¹²⁰¹

The table operations of AuthenticRange now allow to manipulate any table in the current document independent of the current UI selection.

```
// ---- javascript sample ----
// instead of:
// Application.ActiveDocument.DocEditView.RowAppend();
// use now:
if (! Application.ActiveDocument.AuthenticView.Selection.AppendRow())
    MsgBox ("Error: can't append row");
```

Declaration: RowAppend

Description

Appends a row at the current position.

See also [Row operations](#) ¹¹⁷⁰.

26.3.3.3.31 RowDelete (obsolete)

Superseded by [AuthenticRange.DeleteRow](#) ¹²⁰⁵

The table operations of AuthenticRange now allow to manipulate any table in the current document independent of the current UI selection.

```
// ---- javascript sample ----  
// instead of:  
// Application.ActiveDocument.DocEditView.RowDelete();  
// use now:  
if (! Application.ActiveDocument.AuthenticView.Selection.DeleteRow())  
    MsgBox ("Error: can't delete row");
```

Declaration: RowDelete

Description

Deletes the currently selected row(s).

See also [Row operations](#) ¹¹⁷⁰.

26.3.3.32 RowDuplicate (obsolete)

Superseded by [AuthenticRange.DuplicateRow](#) ¹²⁰⁵

The table operations of AuthenticRange now allow to manipulate any table in the current document independent of the current UI selection.

```
// ---- javascript sample ----  
// instead of:  
// Application.ActiveDocument.DocEditView.RowDuplicate();  
// use now:  
if (! Application.ActiveDocument.AuthenticView.Selection.DuplicateRow())  
    MsgBox ("Error: can't duplicate row");
```

Declaration: RowDuplicate

Description

The method duplicates the currently selected rows.

See also [Row operations](#) ¹¹⁷⁰.

26.3.3.33 RowInsert (obsolete)

Superseded by [AuthenticRange.InsertRow](#) ¹²¹⁶

The table operations of AuthenticRange now allow to manipulate any table in the current document independent of the current UI selection.

```
// ---- javascript sample ----  
// instead of:  
// Application.ActiveDocument.DocEditView.RowInsert();  
// use now:  
if (! Application.ActiveDocument.AuthenticView.Selection.InsertRow())  
    MsgBox ("Error: can't insert row");
```

Declaration: RowInsert

Description

Inserts a new row immediately above the current selection.

See also [Row operations](#) ¹¹⁷⁰.

26.3.3.3.34 RowMoveDown (obsolete)

Superseded by [AuthenticRange.MoveRowDown](#) ¹²²³

The table operations of AuthenticRange now allow to manipulate any table in the current document independent of the current UI selection.

```
// ---- javascript sample ----  
// instead of:  
// Application.ActiveDocument.DocEditView.RowMoveDown();  
// use now:  
if (! Application.ActiveDocument.AuthenticView.Selection.MoveRowDown())  
    MsgBox ("Error: can't move row down");
```

Declaration: RowMoveDown

Description

Moves the current row one position down.

See also [Row operations](#) ¹¹⁷⁰.

26.3.3.3.35 RowMoveUp (obsolete)

Superseded by [AuthenticRange.MoveRowUp](#) ¹²²³

The table operations of AuthenticRange now allow to manipulate any table in the current document independent of the current UI selection.

```
// ---- javascript sample ----  
// instead of:  
// Application.ActiveDocument.DocEditView.RowAppend();  
// use now:  
if (! Application.ActiveDocument.AuthenticView.Selection.MoveRowUp())  
    MsgBox ("Error: can't move row up");
```

Declaration: RowMoveUp

Description

Moves the current row one position up.

See also [Row operations](#) ¹¹⁷⁰.

26.3.3.36 SaveXML (obsolete)

Superseded by [AuthenticView.AsXMLString](#) ¹²³⁹

AuthenticView now supports the property XMLString that can be used to directly access and replace the document content as an XMLString.

```
// ---- javascript sample ----  
// instead of:  
// var strDocAsXMLString = Application.ActiveDocument.DocEditView.SaveXML();  
// use now:  
try  
{  
    var strDocAsXMLString = Application.ActiveDocument.AuthenticView.AsXMLString;  
    ... // do something here  
}  
catch (err)  
{ MsgBox ("Error: invalid XML string"); }
```

Declaration: SaveXML as String

Return Value

XML structure as string

Description

Saves the current XML data to a string that is returned to the caller.

26.3.3.37 SelectionMoveTabOrder (obsolete)

Superseded by [AuthenticRange.SelectNext](#)¹²²⁵

AuthenticRange now supports a wide range of element navigation methods based on document elements like characters, words, tags and many more. Selecting the next paragraph is just one of them, and navigation is not necessarily bound to the current UI selection.

```
// ---- javascript sample ----
// instead of:
// Application.ActiveDocument.DocEditView.SelectionMoveTabOrder(true, true);
// use now:
Application.ActiveDocument.AuthenticView.Selection.SelectNext (spyAuthenticParagraph).Select();
// to append a row to a table use AuthenticRange.AppendRow
```

Declaration: SelectionMoveTabOrder (*bForward* as Boolean, *bTag* as Boolean)

Description

SelectionMoveTabOrder() moves the current selection forwards or backwards.

If *bTag* is false and the current selection is at the last cell of a table a new line will be added.

26.3.3.38 SelectionSet (obsolete)

Superseded by [AuthenticRange.FirstXMLData](#)¹²⁰⁷ and related properties

AuthenticRange supports navigation via XMLData elements as well as navigation by document elements (e.g. characters, words, tags) or text cursor positions.

```
// ---- javascript sample ----
// instead of:
// if (! Application.ActiveDocument.DocEditView.SelectionSet(varXMLData1, 0, varXMLData2, -1))
//   MsgBox ("Error: invalid data position");
// use now:
try
{
  var objSelection = Application.ActiveDocument.AuthenticView.Selection;
  objSelection.FirstXMLData = varXMLData1;
  objSelection.FirstXMLdataOffset = 0;
  objSelection.LastXMLData = varXMLData2;
  objSelection.LastXMLDataOffset = -1;
  objSelection.Select();
}
catch (err)
{ MsgBox ("Error: invalid data position"); }
// to select all text between varXMLData1 and varXMLdata2, inclusive
```

Declaration: SelectionSet (*pStartElement* as [XMLData](#)¹³⁷³, *nStartPos* as long, *pEndElement* as [XMLData](#)¹³⁷³, *nEndPos* as long) as Boolean

Description

Use SelectionSet() to set a new selection in the Authentic View. Its possible to set pEndElement to null (nothing) if the selection should be just over one (pStartElement) XML element.

26.3.3.3.39 XMLRoot (obsolete)

Superseded by [AuthenticView.XMLDataRoot](#)¹²⁴⁸

```
// ---- javascript sample ----
// instead of:
// var objXMLData = Application.ActiveDocument.DocEditView.XMLRoot;
// use now:
var objXMLData = Application.ActiveDocument.AuthenticView.XMLDataRoot;
```

Declaration: XMLRoot as [XMLData](#)¹³⁷³

Description

XMLRoot is the parent element of the currently displayed XML structure. Using the [XMLData](#)¹³⁷³ interface you have full access to the complete content of the file.

26.3.4 Enumerations

This is a list of all enumerations used by the XMLSpy API. If your scripting environment does not support enumerations use the number-values instead.

26.3.4.1 ENUMApplicationStatus

Enumeration to specify the current Application status.

| | |
|--|-----|
| eApplicationRunning | = 0 |
| eApplicationAfterLicenseCheck | = 1 |
| eApplicationBeforeLicenseCheck | = 2 |
| eApplicationConcurrentLicenseCheckFailed | = 3 |
| eApplicationProcessingCommandLine | = 4 |

26.3.4.2 SPYAttributeTypeDefinition

Attribute type definition that can be selected for generation of Sample XML. This type is used with the method [GenerateDTDOrSchema](#)¹²⁸⁰ and [GenerateDTDOrSchemaEx](#)¹²⁸⁰.

| | |
|-------------------|-----|
| spyMergedGlobal | = 0 |
| spyDistinctGlobal | = 1 |
| spyLocal | = 2 |

26.3.4.3 SPYAuthenticActions

Actions that can be performed on [AuthenticRange](#)¹¹⁹⁹ objects.

| | |
|--------------------------|-----|
| spyAuthenticInsertAt | = 0 |
| spyAuthenticApply | = 1 |
| spyAuthenticClearSurr | = 2 |
| spyAuthenticAppend | = 3 |
| spyAuthenticInsertBefore | = 4 |
| spyAuthenticRemove | = 5 |

26.3.4.4 SPYAuthenticDocumentPosition

Relative and absolute positions used for navigating with [AuthenticRange](#)¹¹⁹⁹ objects.

| | |
|---------------------------|-----|
| spyAuthenticDocumentBegin | = 0 |
| spyAuthenticDocumentEnd | = 1 |
| spyAuthenticRangeBegin | = 2 |
| spyAuthenticRangeEnd | = 3 |

26.3.4.5 SPYAuthenticElementActions

Actions that can be used with the obsolete object `GetAllowedElements` (superseded by [AuthenticRange.CanPerformActionWith](#)¹²⁰²).

| | |
|-------------------|-----|
| k_ActionInsertAt | = 0 |
| k_ActionApply | = 1 |
| k_ActionClearSurr | = 2 |

| | |
|----------------------|-----|
| k_ActionAppend | = 3 |
| k_ActionInsertBefore | = 4 |
| k_ActionRemove | = 5 |

26.3.4.6 SPYAuthenticElementKind

Enumeration of the different kinds of elements used for navigation and selection within the [AuthenticRange](#)¹¹⁹⁹ and [AuthenticView](#)¹²²⁹ objects.

| | |
|-------------------------|------|
| spyAuthenticChar | = 0 |
| spyAuthenticWord | = 1 |
| spyAuthenticLine | = 3 |
| spyAuthenticParagraph | = 4 |
| spyAuthenticTag | = 6 |
| spyAuthenticDocument | = 8 |
| spyAuthenticTable | = 9 |
| spyAuthenticTableRow | = 10 |
| spyAuthenticTableColumn | = 11 |

26.3.4.7 SPYAuthenticMarkupVisibility

Enumeration values to customize the visibility of markup with [MarkupVisibility](#)¹²⁴⁵.

| | |
|--------------------------|-----|
| spyAuthenticMarkupHidden | = 0 |
| spyAuthenticMarkupSmall | = 1 |
| spyAuthenticMarkupLarge | = 2 |
| spyAuthenticMarkupMixed | = 3 |

26.3.4.8 SPYAuthenticToolBarButtonState

Authentic toolbar button states are given by the following enumerations.

| | |
|--------------------------------|-----|
| authenticToolBarButtonDefault | = 0 |
| authenticToolBarButtonEnabled | = 1 |
| authenticToolBarButtonDisabled | = 2 |

26.3.4.9 SPYDatabaseKind

Values to select different kinds of databases for import. See [DatabaseConnection.DatabaseKind](#)¹²⁵⁷ for its use.

| | |
|-------------------|-----|
| spyDB_Access | = 0 |
| spyDB_SQLServer | = 1 |
| spyDB_Oracle | = 2 |
| spyDB_Sybase | = 3 |
| spyDB_MySQL | = 4 |
| spyDB_DB2 | = 5 |
| spyDB_Other | = 6 |
| spyDB_Unspecified | = 7 |
| spyDB_PostgreSQL | = 8 |
| spyDB_iSeries | = 9 |

26.3.4.10 SPYDialogAction

Values to simulate different interactions on dialogs. See [Dialogs](#)¹²⁶¹ for all dialogs available.

| | | |
|--------------------|-----|---|
| spyDialogOK | = 0 | // simulate click on OK button |
| spyDialogCancel | = 1 | // simulate click on Cancel button |
| spyDialogUserInput | = 2 | // show dialog and allow user interaction |

26.3.4.11 SPYDOMType

Enumeration values to parameterize generation of C++ code from schema definitions.

| | | |
|--------------------|-----|----------|
| spyDOMType_msxml4 | = 0 | Obsolete |
| spyDOMType_xerces | = 1 | |
| spyDOMType_xerces3 | = 2 | |
| spyDOMType_msxml6 | = 3 | |

spyDOMType_xerces indicates Xerces 2.x usage.
 spyDOMType_xerces3 indicates Xerces 3.x usage.

26.3.4.12 SPYDTDSchemaFormat

Enumeration to identify the different schema formats.

| | |
|--------|-----|
| spyDTD | = 0 |
| spyW3C | = 1 |

26.3.4.13 SPYEncodingByteOrder

Enumeration values to specify encoding byte ordering for text import and export.

| | |
|------------------|-----|
| spyNONE | = 0 |
| spyLITTLE_ENDIAN | = 1 |
| spyBIG_ENDIAN | = 2 |

26.3.4.14 SPYExportNamespace

Enumeration type to configure handling of namespace identifiers during export.

| | |
|-------------------------------|-----|
| spyNoNamespace | = 0 |
| spyReplaceColonWithUnderscore | = 1 |

26.3.4.15 SPYFindInFilesSearchLocation

The different locations where a search can be performed. This type is used with the [FindInFilesDlg](#)¹³¹⁰ dialog.

| | |
|--------------------------|-----|
| spyFindInFiles_Documents | = 0 |
| spyFindInFiles_Project | = 1 |
| spyFindInFiles_Folder | = 2 |

26.3.4.16 SPYFrequentElements

Enumeration values to parameterize schema generation.

| | |
|----------------------|-----|
| spyGlobalElements | = 0 |
| spyGlobalComplexType | = 1 |

26.3.4.17 SPYImageKind

Enumeration values to parameterize image type of the generated documentation. These values are used in [SchemaDocumentationDialog.DiagramFormat](#)¹³⁴⁷.

| | |
|------------------|-----|
| spyImageType_PNG | = 0 |
| spyImageType_EMF | = 1 |

26.3.4.18 SPYImportColumnsType

Enumeration to specify different Import columns types.

| | |
|----------------------------|-----|
| spyImportColumns_Element | = 0 |
| spyImportColumns_Attribute | = 1 |

26.3.4.19 SPYKeyEvent

Enumeration type to identify the different key events. These events correspond with the equally named windows messages.

| | |
|---------------|-----|
| spyKeyDown | = 0 |
| spyKeyUp | = 1 |
| spyKeyPressed | = 2 |

26.3.4.20 SPYKeyStatus

Enumeration type to identify the key status.

| | |
|----------------------|------|
| spyLeftShiftKeyMask | = 1 |
| spyRightShiftKeyMask | = 2 |
| spyLeftCtrlKeyMask | = 4 |
| spyRightCtrlKeyMask | = 8 |
| spyLeftAltKeyMask | = 16 |
| spyRightAltKeyMask | = 32 |

26.3.4.21 SPYLibType

Enumeration values to parameterize generation of C++ code from schema definitions.

| | |
|-------------------|-----|
| spyLibType_static | = 0 |
| spyLibType_dll | = 1 |

26.3.4.22 SPYLoading

Enumeration values to define loading behaviour of URL files.

| | |
|------------------|-----|
| spyUseCacheProxy | = 0 |
| spyReload | = 1 |

26.3.4.23 SPYMouseEvent

Enumeration type that defines the mouse status during a mouse event. Use the enumeration values as bitmasks rather than directly comparing with them.

| | |
|--------------------------|--|
| spyNoButtonMask | = 0 |
| spyMouseMoveMask | = 1 |
| spyLeftButtonMask | = 2 |
| spyMiddleButtonMask | = 4 |
| spyRightButtonMask | = 8 |
| spyButtonUpMask | = 16 |
| spyButtonDownMask | = 32 |
| spyDoubleClickMask | = 64 |
| spyShiftKeyDownMask | = 128 |
| spyCtrlKeyDownMask | = 256 |
| spyLeftButtonDownMask | = 34 // spyLeftButtonMask spyButtonDownMask |
| spyMiddleButtonDownMask | = 36 // spyMiddleButtonMask spyButtonDownMask |
| spyRightButtonDownMask | = 40 // spyRightButtonMask spyButtonDownMask |
| spyLeftButtonUpMask | = 18 // spyLeftButtonMask spyButtonUpMask |
| spyMiddleButtonUpMask | = 20 // spyMiddleButtonMask spyButtonUpMask |
| spyRightButtonUpMask | = 24 // spyRightButtonMask spyButtonUpMask |
| spyLeftDoubleClickMask | = 66 // spyRightButtonMask spyButtonUpMask |
| spyMiddleDoubleClickMask | = 68 // spyMiddleButtonMask spyDoubleClickMask |

| | |
|-------------------------|---|
| spyRightDoubleClickMask | = 72 // spyRightButtonMask spyDoubleClickMask |
|-------------------------|---|

Examples

```
' to check for ctrl-leftbutton-down in VB
If (i_eMouseEvent = (XMLSpyLib.spyLeftButtonDownMask Or XMLSpyLib.spyCtrlKeyDownMask)) Then
    ' react on ctrl-leftbutton-down
End If
```

```
' to check for double-click with any button in VBScript
If ((i_eMouseEvent And spyDoubleClickMask) <> 0) Then
    ' react on double-click
End If
```

26.3.4.24 SPYNumberDateTimeFormat

Enumeration value to configure database connections.

| | |
|---------------------|-----|
| spySystemLocale | = 0 |
| spySchemaCompatible | = 1 |

26.3.4.25 SPYProgrammingLanguage

Enumeration values to select the programming language for code generation from schema definitions. Only available/enabled in the Enterprise edition. An error is returned, if accessed by any other version.

| | |
|----------------------|------|
| spyUndefinedLanguage | = -1 |
| spyJava | = 0 |
| spyCpp | = 1 |
| spyCSharp | = 2 |

26.3.4.26 SPYProjectItemTypes

Enumeration values to identify the different elements in project item lists. See [SpyProjectItem.ItemType](#)¹³⁶¹.

| | |
|----------------|-----|
| spyUnknownItem | = 0 |
| spyFileItem | = 1 |
| spyFolderItem | = 2 |
| spyURLItem | = 3 |

26.3.4.27 SPYProjectType

Enumeration values to generation C# and C++ code from schema definitions.

| | | |
|----------------------------|-----|---------|
| spyVisualStudio2010Project | = 6 | |
| spyVisualStudio2013Project | = 7 | |
| spyVisualStudio2015Project | = 8 | |
| spyVisualStudio2017Project | = 9 | |
| spyVisualStudio2019Project | =10 | |
| spyDotNetCore3_1_Project | =11 | C# only |
| spyDotNet5_0_Project | =12 | C# only |
| spyDotNet6_0_Project | =13 | C# only |
| spyVisualStudio2022Project | =14 | |
| spyDotNet8_0_Project | =15 | C# only |

26.3.4.28 SpySampleXMLGenerationChoiceMode

This enumeration is used in [GenerateSampleXMLDlg.ChoiceMode](#)¹³²³:

| | |
|--------------------------------|-----|
| spySampleXMLGen_FirstBranch | = 0 |
| spySampleXMLGen_AllBranches | = 1 |
| spySampleXMLGen_ShortestBranch | = 2 |

26.3.4.29 SPYSampleXMLGenerationOptimization (Obsolete)

This enumeration is OBSOLETE since v2014.

Specify the elements that will be generated in the Sample XML. This enumeration is used in [GenerateSampleXMLDlg](#)¹³²².

| | |
|--------------------------------------|-----|
| spySampleXMLGen_Optimized | = 0 |
| spySampleXMLGen_NonMandatoryElements | = 1 |
| spySampleXMLGen_Everything | = 2 |

26.3.4.30 SpySampleXMLGenerationSampleValueHints

This enumeration is used in [GenerateSampleXMLDlg.SampleValueHints](#)¹³²⁷

| | |
|------------------------------|-----|
| spySampleXMLGen_FirstFit | = 0 |
| spySampleXMLGen_RandomFit | = 1 |
| spySampleXMLGen_CycleThrough | = 2 |

26.3.4.31 SPYSampleXMLGenerationSchemaOrDTDAssignment

Specifies what kind of reference to the schema/DTD should be added to the generated Sample XML. This enumeration is used in [GenerateSampleXMLDlg](#)¹³²².

| | |
|----------------------------------|-----|
| spySampleXMLGen_AssignRelatively | = 0 |
| spySampleXMLGen_AssignAbsolutely | = 1 |
| spySampleXMLGen_DoNotAssign | = 2 |

26.3.4.32 SPYSchemaDefKind

Enumeration type to select schema diagram types.

| | |
|-------------------------|------|
| spyKindElement | = 0 |
| spyKindComplexType | = 1 |
| spyKindSimpleType | = 2 |
| spyKindGroup | = 3 |
| spyKindModel | = 4 |
| spyKindAny | = 5 |
| spyKindAttr | = 6 |
| spyKindAttrGroup | = 7 |
| spyKindAttrAny | = 8 |
| spyKindIdentityUnique | = 9 |
| spyKindIdentityKey | = 10 |
| spyKindIdentityKeyRef | = 11 |
| spyKindIdentitySelector | = 12 |
| spyKindIdentityField | = 13 |
| spyKindNotation | = 14 |
| spyKindInclude | = 15 |

| | |
|-----------------|------|
| spyKindImport | = 16 |
| spyKindRedefine | = 17 |
| spyKindFacet | = 18 |
| spyKindSchema | = 19 |
| spyKindCount | = 20 |

26.3.4.33 SPYSchemaDocumentationFormat

Enumeration values to parameterize generation of schema documentation. These values are used in [SchemaDocumentationDialog.OutputFormat](#)¹³⁵³.

| | |
|---------------------|-----|
| spySchemaDoc_HTML | = 0 |
| spySchemaDoc_MSWord | = 1 |
| spySchemaDoc_RTF | = 2 |
| spySchemaDoc_PDF | = 3 |

26.3.4.34 SPYSchemaExtensionType

Enumeration to specify different Schema Extension types.

| | |
|----------------------------------|-----|
| spySchemaExtension_None | = 0 |
| spySchemaExtension_SQL_XML | = 1 |
| spySchemaExtension_MS_SQL_Server | = 2 |
| spySchemaExtension_Oracle | = 3 |

26.3.4.35 SPYSchemaFormat

Enumeration to specify different Schema Format types.

| | |
|------------------------------|-----|
| spySchemaFormat_Hierarchical | = 0 |
| spySchemaFormat_Flat | = 1 |

26.3.4.36 SPYTextDelimiters

Enumeration values to specify text delimiters for text export.

| | |
|--------------|-----|
| spyTabulator | = 0 |
| spySemicolon | = 1 |
| spyComma | = 2 |
| spySpace | = 3 |

26.3.4.37 SPYTextEnclosing

Enumeration value to specify text enclosing characters for text import and export.

| | |
|----------------|-----|
| spyNoEnclosing | = 0 |
| spySingleQuote | = 1 |
| spyDoubleQuote | = 2 |

26.3.4.38 SPYTypeDetection

Enumeration to select how type detection works during [GenerateDTDOrSchema](#)¹²⁸⁰ and [GenerateDTDOrSchemaEx](#)¹²⁸⁰.

| | |
|-----------------|-----|
| spyBestPossible | = 0 |
| spyNumbersOnly | = 1 |
| spyNoDetection | = 2 |

26.3.4.39 SPYURLTypes

Enumeration to specify different URL types.

| | |
|----------------|------|
| spyURLTypeAuto | = -1 |
| spyURLTypeXML | = 0 |
| spyURLTypeDTD | = 1 |

26.3.4.40 SPYValidateXSDVersion

Description

Enumeration values that select what XSD version to use. The XSD version that is selected depends on both (i) the presence/absence—and, if present, the value—of the `/xs:schema/@vc:minVersion` attribute of the XSD document, and (ii) the value of this enumeration.

| | |
|----------------------------------|-----|
| spyValidateXSDVersion_AutoDetect | = 0 |
| spyValidateXSDVersion_1_1 | = 1 |
| spyValidateXSDVersion_1_0 | = 2 |

spyValidateXSDVersion_1_0 selects XSD 1.0 if `vc:minVersion` is absent, or is present with any value.
 spyValidateXSDVersion_1_1 selects XSD 1.1 if `vc:minVersion` is absent, or is present with any value.
 spyValidateXSDVersion_AutoDetect selects XSD 1.1 if `vc:minVersion=1.1`. If the `vc:minVersion` attribute is absent, or is present with a value other than 1.1, then XSD 1.0 is selected.

26.3.4.41 SPYValidateErrorFormat

Enumeration values that select the format of the error message.

| | |
|---------------------------------|-----|
| spyValidateErrorFormat_Text | = 0 |
| spyValidateErrorFormat_ShortXML | = 1 |
| spyValidateErrorFormat_LongXML | = 2 |

26.3.4.42 SPYViewModes

Enumeration values that define the different view modes for XML documents. The mode *spyViewAuthentic(4)* identifies the mode that was intermediately called DocEdit mode and is now called Authentic mode. The mode *spyViewJsonSchema* identifies a mode which is mapped to the Schema Design View on the GUI but is distinguished internally.

| | |
|--------------------|-----------------|
| spyViewGrid | = 0 |
| spyViewText | = 1 |
| spyViewBrowser | = 2 |
| spyViewSchema | = 3 |
| spyViewContent | = 4 // obsolete |
| spyViewAuthentic | = 4 |
| spyViewWSDL | = 5 |
| spyViewZIP | = 6 |
| spyViewEditionInfo | = 7 |
| spyViewXBRL | = 8 |
| spyViewJsonSchema | = 9 |

26.3.4.43 SPYVirtualKeyMask

Enumeration type for the most frequently used key masks that identify the status of the virtual keys. Use these values as bitmasks rather than directly comparing with them. When necessary, you can create further masks by using the 'logical or' operator.

| | |
|----------------------|---|
| spyNoVirtualKeyMask | = 0 |
| spyLeftShiftKeyMask | = 1 |
| spyRightShiftKeyMask | = 2 |
| spyLeftCtrlKeyMask | = 4 |
| spyRightCtrlKeyMask | = 8 |
| spyLeftAltKeyMask | = 16 |
| spyRightAltKeyMask | = 32 |
| spyShiftKeyMask | = 3 // spyLeftShiftKeyMask spyRightShiftKeyMask |
| spyCtrlKeyMask | = 12 // spyLeftCtrlKeyMask spyRightCtrlKeyMask |
| spyAltKeyMask | = 48 // spyLeftAltKeyMask spyRightAltKeyMask |

Examples

```
' VBScript sample: check if ctrl-key is pressed
If ((i_nVirtualKeyStatus And spyCtrlKeyMask) <> 0) Then
  ' ctrl-key is pressed
End If

' VBScript sample: check if ONLY ctrl-key is pressed
If (i_nVirtualKeyStatus == spyCtrlKeyMask) Then
  ' exactly ctrl-key is pressed
End If

// JScript sample: check if any of the right virtual keys is pressed
if ((i_nVirtualKeyStatus & (spyRightShiftKeyMask | spyRightCtrlKeyMask |
spyRightAltKeyMask)) != 0)
{
  ; ' right virtual key is pressed
}
```

26.3.4.44 SPYXMLDataKind

The different types of XMLData elements available for XML documents.

| | |
|------------------------------|-----|
| spyXMLDataXMLDocStruct | = 0 |
| spyXMLDataXMLEntityDocStruct | = 1 |
| spyXMLDataDTDDocStruct | = 2 |
| spyXMLDataXML | = 3 |

| | |
|-------------------------|------|
| spyXMLDataElement | = 4 |
| spyXMLDataAttr | = 5 |
| spyXMLDataText | = 6 |
| spyXMLDataCData | = 7 |
| spyXMLDataComment | = 8 |
| spyXMLDataPI | = 9 |
| spyXMLDataDefDoctype | = 10 |
| spyXMLDataDefExternalID | = 11 |
| spyXMLDataDefElement | = 12 |
| spyXMLDataDefAttlist | = 13 |
| spyXMLDataDefEntity | = 14 |
| spyXMLDataDefNotation | = 15 |
| spyXMLDataKindsCount | = 16 |

26.3.5 Application API for Java (obsolete)

The objects described in this section (Application API for Java) are obsolete from v2012 onwards.

For information about how to access the Application API from Java code, see the section: [Programming Languages | Java](#)¹¹⁵⁹.

The Application API in Java has an interface built up of Java classes, each of which corresponds to an object in the [Application API](#)¹¹³⁴. Developers can use these Java classes to interact with the COM API. These classes are listed below and described in subsequent sections. For a description of the [Application API](#)¹¹³⁴ objects themselves, see the [Application API documentation](#)¹¹³⁴. Bear in mind that some API features are only available in scripting environments; these have therefore not been ported to Java.

Java classes

[SpyApplication](#)¹⁴³⁹
[SpyProject](#)¹⁴⁵³
[SpyProjectItems](#)¹⁴⁵³
[SpyProjectItem](#)¹⁴⁵³
[SpyDocuments](#)¹⁴⁴⁵
[SpyDoc](#)¹⁴⁴³
[SpyAuthenticView](#)¹⁴⁶⁰
[SpyAuthenticRange](#)¹⁴⁵⁹
[SpyDocEditView](#)¹⁴⁶¹
[SpyDocEditSelection](#)¹⁴⁶¹

- [SpyGridView](#) ¹⁴⁵²
- [SpyTextView](#) ¹⁴⁵⁷
- [SpyXMLData](#) ¹⁴⁵⁸
- [SpyDialogs](#) ¹⁴⁴³
- [SpyCodeGeneratorDlg](#) ¹⁴⁴¹
- [SpyDTDSchemaGeneratorDlg](#) ¹⁴⁴⁶
- [SpyFileSelectionDlg](#) ¹⁴⁴⁸
- [SpyFindInFilesDlg](#) ¹⁴⁴⁹
- [SpyGenerateSampleXMLDlg](#) ¹⁴⁵¹
- [SpySchemaDocumentationDlg](#) ¹⁴⁵⁴
- [SpyDatabaseConnection](#) ¹⁴⁴²
- [SpyElementList](#) ¹⁴⁴⁷
- [SpyElementListItem](#) ¹⁴⁴⁷
- [SpyExportSettings](#) ¹⁴⁴⁸
- [SpyFindInFilesResults](#) ¹⁴⁵¹
- [SpyFindInFilesResult](#) ¹⁴⁵⁰
- [SpyFindInFilesMatch](#) ¹⁴⁵⁰
- [SpyTextImportExportSettings](#) ¹⁴⁵⁷

Implementation of COM properties in Java

Properties in Java have been defined to include both a **set** and **get** method (set if it is allowed by the COM implementation). For example, the COM class `Document` contains the `GridView` property. In Java the method is called `SpyDoc` and the property is defined as a `GetGridView` method.

If you encounter compiling problems, please check the following points:

- The `xmlspylib.dll` must be available in `..\windows\system32`.
- The `XMLSpyInterface.jar` file must be inserted in the `ClassPath` environment variable.

Setting the `ClassPath` variable in Windows XP

1. Click **Start | Settings | Control panel | System | Advanced | Environment Variables**. This opens the Environment Variables dialog box.
2. If a `ClassPath` entry already exists in the **System variables** group, select the `ClassPath` entry, and click the **Edit** button. Edit the path to: `"C:\Program Files\Altova\xmlspy\XMLSpyInterface.jar"`.

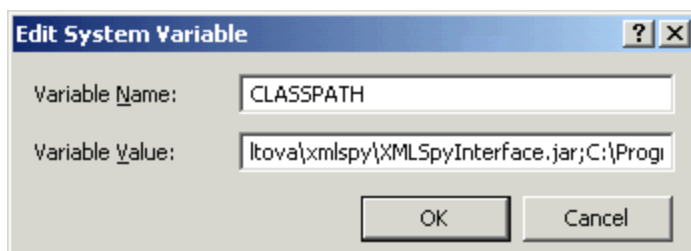

If a `ClassPath` entry does not exist in the System variables group, click the **New** button. The New System Variable dialog pops up. Enter `CLASSPATH` as the variable name, and `"C:\Program Files\Altova\xmlspy\XMLSpyInterface.jar"` as the `ClassPath` variable (alter the path to match your installation, if necessary).

26.3.5.1 Sample source code (obsolete)

The objects described in this section (Application API for Java) are obsolete from v2012 onwards.

For information about how to access the Application API from Java code, see the section: [Programming Languages | Java¹¹⁵⁹](#).

The "SpyDoc doc = app.GetDocuments().OpenFile(...)" command parameter must be altered to suit your environment.

What the sample does:

- Starts a new XMLSpy instance
- Opens the Datasheet.xml file (alter the path here...)
- Switches to the Enhanced Grid view
- Appends a new child element called "NewChild" with the text value "NewValuE" element to the root element
- Checks if the document is valid and outputs a message to the Java console
- Quits and releases the XMLSpy application

```
import XMLSpyInterface.*;

public class TestSpyInterface
{
    public TestSpyInterface() {}

    public static void main(String[] args)
    {
        SpyApplication app = null;
        SpyDoc oDoc = null;
        SpyXMLData oData = null;
        SpyXMLData oNewChild = null;

        try
        {
            app = new SpyApplication();
            app.ShowApplication( true );

            oDoc = app.GetDocuments().OpenFile("C:\\FilePath\\OrgChart.xml", true );

            // OrgChart.xml is in the folder C:\Documents and Settings\\My
            // Documents\Altova\XMLSpy2024. The filepath should be in
            // the form: C:\\Documents and Settings\\Username\\Folder\\Filename.xml

            if ( oDoc != null )
            {
                oDoc.SwitchViewMode(SPYViewModes.spyViewGrid);
            }
        }
    }
}
```

```

oData = oDoc.GetRootElement();
oNewChild = oDoc.CreateChild(SPYXMLDataKind.spyXMLDataElement);

oNewChild.SetName( "NewChild" );
oNewChild.SetTextValue("newVaLuE");
oData.AppendChild(oNewChild);

if ( oDoc.IsValid() == false )
{
    // is to be expected after above insertion
    System.out.println( "!!!!!!validation error: " + oDoc.GetErrorString() );
    System.out.println( "!!!!!!validation error: " + oDoc.GetErrorPos() );
    System.out.println( "!!!!!!validation error: " + oDoc.GetBadData() );

}

app.Quit();
}
finally
{
    // Free any allocated resources by calling ReleaseInstance().
    if ( oNewChild != null )
        oNewChild.ReleaseInstance();

    if ( oData != null )
        oData.ReleaseInstance();

    if ( oDoc != null )
        oDoc.ReleaseInstance();

    if ( app != null )
        app.ReleaseInstance();
}
}
}

```

If you have difficulties compiling this sample, please try the following commands on the **(Start | Run | cmd)** command line. Please make sure you are currently in the folder that contains the sample java file.

compilation

```
javac -classpath c:\yourpathhere\XMLSpyInterface.jar testspyinterface.java
```

Execution

```
java -classpath c:\yourpathhere\XMLSpyInterface.jar testspyinterface
```

26.3.5.2 SpyApplication (obsolete)

The objects described in this section (Application API for Java) are obsolete from v2012 onwards.

For information about how to access the Application API from Java code, see the section: [Programming Languages | Java](#)¹¹⁵⁹.

```

public class SpyApplication
{
    public void ReleaseInstance1438 ();
    public void ShowApplication1190 ( boolean bShow );
    public void Quit1188 ();
    public void AddMacroMenuItem1176 ( String sMacro, String sDisplayText );
    public void ClearMacroMenu1177 ();
    public SpyDoc1443 GetActiveDocument1175 ();
    public SpyProject1453 GetCurrentProject1177 ();
    public SpyDocuments1445 GetDocuments1178 ();
    public SpyElementList1447 GetDatabaseImportElementList1179 ( SpyDatabaseConnection1442
oImportSettings );
    public SpyDatabaseConnection1442 GetDatabaseSettings1179 ();
    public SpyElementList1447 GetDatabaseTables1180 ( SpyDatabaseConnection1442 oImportSettings );
    public SpyExportSettings1448 GetExportSettings1181 ();
    public SpyElementList1447 GetTextImportElementList1181 ( SpyTextImportExportSettings1457
oImportSettings );
    public SpyTextImportExportSettings1457 GetTextImportExportSettings1182 ();
    public SpyDoc1443 ImportFromDatabase1183 ( SpyDatabaseConnection1442 oImportSettings,
SpyElementList1447 oElementList );
    public SpyDoc1443 ImportFromSchema1184 ( SpyDatabaseConnection1442 oImportSettings, String
strTable, SpyDoc1443 oSchemaDoc );
    public SpyDoc1443 ImportFromText1185 ( SpyTextImportExportSettings1457 oImportSettings,
SpyElementList1447 oElementList );
    public SpyDoc1443 ImportFromWord1185 ( String sFile );
    public void NewProject1187 ( String sPath, boolean bDiscardCurrent );
    public void OpenProject1187 (String sPath , boolean bDiscardCurrent, boolean bDialog );
    public long ShowForm1190 ( String sName );
    public void URLDelete1191 ( String sURL, String sUser, String sPassword );
    public void URLMakeDirectory1191 ( String sURL, String sUser, String sPassword );
    public int GetWarningNumber1192 ();
    public String GetWarningText1192 ();

    // since Version 2004R4
    public SpyApplication1439 GetApplication1176 ();
    public SpyApplication1439 GetParent1188 ();
    public SpyDialogs1443 GetDialogs1178 ();
    public boolean GetVisible1192 ();
    public void SetVisible1192 ( boolean i_bVisibility );
    public long GetWindowHandle ();

    public void ReloadSettings1188 ();
    public SpyFindInFilesResults1451 FindInFiles1179 ( SpyFindInFilesDlg1449 dlgSettings );
    public boolean ShowFindInFiles1190 ( SpyFindInFilesDlg1449 dlgSettings );
    public void Selection ( String sVal );

    public long Status1191 ();

```

```

public int MajorVersion1186 ();
public int MinorVersion1186 ();
public String Edition1178 ();
public boolean IsAPISupported1186 ();
public long ServicePackVersion1189 ();
public void CreateXMLSchemaFromDBStructure1177 ( SpyDatabaseConnection1442 oConnection,
SpyElementList1447 oTables );
}

```

26.3.5.3 SpyCodeGeneratorDlg (obsolete)

The objects described in this section (Application API for Java) are obsolete from v2012 onwards.

For information about how to access the Application API from Java code, see the section: [Programming Languages | Java¹¹⁵⁹](#).

Only available/enabled in the Enterprise edition. An error is returned, if accessed by any other version.

```

// since version 2004R4
public class SpyCodeGeneratorDlg
{
public void ReleaseInstance1438 ();
public SpyApplication1439 GetApplication1249 ();
public SpyDialogs1443 GetParent1253 ();
public long1471 GetProgrammingLanguage1253 ();
public void SetProgrammingLanguage1253 ( long1471 i_eVal );
public String GetTemplateFileName1254 ();
public void SetTemplateFileName1254 ( String i_strVal );
public String GetOutputPath1252 ();
public void SetOutputPath1252 ( String i_strVal );
public long1466 GetOutputPathDialogAction1252 ();
public void SetOutputPathDialogAction1252 ( long1466 i_eVal );
public long1466 GetPropertySheetDialogAction1254 ();
public void SetPropertySheetDialogAction1254 ( long1466 i_eVal );
public long1466 GetOutputResultDialogAction1253 ();
public void SetOutputResultDialogAction1253 ( long1466 i_eVal );
public long1467 GetCPPSettings_DOMType1250 ();
public void SetCPPSettings_DOMType1250 ( long1467 i_eVal );
public long1470 GetCPPSettings_LibraryType1251 ();
public void SetCPPSettings_LibraryType1251 ( long1470 i_eVal );
public boolean GetCPPSettings_UseMFC1251 ();
public void SetCPPSettings_UseMFC1251 ( boolean i_bVal );
public long1472 GetCSharpSettings_ProjectType1252 ();
public void SetCSharpSettings_ProjectType1252 ( long1472 i_eVal );
}

```

26.3.5.4 SpyDatabaseConnection (obsolete)

The objects described in this section (Application API for Java) are obsolete from v2012 onwards.

For information about how to access the Application API from Java code, see the section: [Programming Languages | Java](#)¹¹⁵⁹.

```
public class SpyDatabaseConnection
{
    public void ReleaseInstance1438 ();
    public String GetADODConnection1255 ();
    public void SetADODConnection1255 ( String sValue );
    public boolean GetAsAttributes1256 ();
    public void SetAsAttributes1256 ( boolean bValue );
    public boolean GetCreateMissingTables1256 ();
    public void SetCreateMissingTables1256 ( boolean bValue );
    public boolean GetCreateNew1256 ();
    public void SetCreateNew1256 ( boolean bValue );
    public boolean GetExcludeKeys1257 ();
    public void SetExcludeKeys1257 ( boolean bValue );
    public String GetFile1257 ();
    public void SetFile1257 ( String sValue );
    public boolean GetIncludeEmptyElements1258 ();
    public void SetIncludeEmptyElements1258 ( boolean bValue );
    public long GetNumberDateTimeFormat1471 ();
    public void SetNumberDateTimeFormat1259 ( long 1471 nValue );
    public String GetODBCConnection1259 ();
    public void SetODBCConnection1259 ( String sValue );
    public String GetSQLSelect1260 ();
    public void SetSQLSelect1260 ( String sValue );
    public long GetTextFieldLen1260 ();
    public void SetTextFieldLen1260 ( long nValue );

    // since version 2004R4
    public long GetDatabaseKind1466 1257 ();
    public void SetDatabaseKind1257 ( long 1466 nValue );

    // since version 2008R2
    public boolean GetCommentIncluded1256 ();
    public void SetCommentIncluded1256 ( boolean bValue );
    public String GetNullReplacement1258 ();
    public void SetNullReplacement1258 ( String sValue );
    public String GetDatabaseSchema1257 ();
    public void SetDatabaseSchema1257 ( String sValue );
}
```

```

// since version 2010r3
public boolean GetPrimaryKeys1259 ()
public void SetPrimaryKeys1259 ( boolean bValue )
public boolean GetForeignKeys1258 ()
public void SetForeignKeys1258 ( boolean bValue )
public boolean GetUniqueKeys1260 ()
public void SetUniqueKeys1260 ( boolean bValue )
public long GetSchemaExtensionType1259 ( long 1474 nValue )
public void SetSchemaExtensionType1259 ( long 1474 nValue )
public long GetSchemaFormat1260 ( )
public void SetSchemaFormat1260 ( long 1475 nValue )
public long GetImportColumnsType1258 ( )
public void SetImportColumnsType1258 ( long 1470 nValue )
}

```

26.3.5.5 SpyDialogs (obsolete)

The objects described in this section (Application API for Java) are obsolete from v2012 onwards.

For information about how to access the Application API from Java code, see the section: [Programming Languages | Java](#)¹¹⁵⁹.

```

// Since version 2004R4
public class SpyDialogs
{
public SpyApplication1439 GetApplication1261 ();
public SpyApplication1439 GetParent1262 ();
public SpyCodeGeneratorDlg1441 GetCodeGeneratorDlg1261 ();
public SpyFileSelectionDlg1448 GetFileSelectionDlg1262 ();
public SpySchemaDocumentationDlg1454 GetSchemaDocumentationDlg1263 ();
public SpyGenerateSampleXMLDlg1451 GetGenerateSampleXMLDlg1263 ();
public SpyDTDSchemaGeneratorDlg1446 GetDTDSchemaGeneratorDlg1263 ();
public SpyFindInFilesDlg1449 GetFindInFilesDlg1263 ();
}

```

26.3.5.6 SpyDoc (obsolete)

The objects described in this section (Application API for Java) are obsolete from v2012 onwards.

For information about how to access the **Application API** from Java code, see the section: [Programming Languages | Java](#)¹¹⁵⁹.

```

public class SpyDoc
{
    public void ReleaseInstance1438 ();
    public void SetEncoding1275 ( String strEncoding );
    public void SetPathName1275 ( String strPath );
    public String GetPathName1283 ();
    public String GetTitle1293 ();
    public boolean IsModified1284 ();
    public void Save1288 ();
    public void Close1271 ( boolean bDiscardChanges );
    public void UpdateViews1294 ();
    public long GetCurrentViewMode1477 ();
    public boolean SwitchViewMode1292 ( long nMode );
    public SpyGridView1452 GetGridView1284 ();
    public void SetActiveDocument1290 ();
    public void StartChanges1291 ();
    public void EndChanges1276 ();
    public void TransformXSL1293 ();
    public void AssignDTD1269 ( String sDTDFile, boolean bDialog );
    public void AssignSchema1269 ( String sSchemaFile, boolean bDialog );
    public void AssignXSL1269 ( String sXSLFile, boolean bDialog );
    public void ConvertDTDOrSchema1271 ( long nFormat, long nFrequentElements );
    public SpyXMLData1458 CreateChild1273 ( long nKind );
    public void CreateSchemaDiagram1274 ( long nKind, String sName, String sFile );
    public SpyDocEditView1461 GetDocEditView1275 ();
    public void ExportToDatabase1277 ( SpyXMLData1458 oFromChild, SpyExportSettings1448
oExportSettings, SpyDatabaseConnection1442 oDatabaseConnection );
    public void ExportToText1278 ( SpyXMLData1458 oFromChild, SpyExportSettings1448
oExportSettings, SpyTextImportExportSettings1457 oTextSettings );
    public void GenerateDTDOrSchema1280 ( long nFormat, int nValuesList, long nDetection,
long nFrequentElements );
    public SpyElementList1447 GetExportElementList1283 ( SpyXMLData1458 oFromChild,
SpyExportSettings1448 oExportSettings );
    public SpyXMLData1458 GetRootElement1288 ();
    public String SaveInString1289 ( SpyXMLData1458 oData, boolean bMarked );
    public void SaveToURL1289 ( String sUrl, String sUser, String sPassword );
    public String GetErrorString (); // See IsValid1284 () or IsWellFormed1286 ()
    public int GetErrorPos (); // See IsValid1284 () or IsWellFormed1286 ()
    public SpyXMLData1458 GetBadData (); // See IsValid1284 () or IsWellFormed1286 ()
    public boolean IsValid1284 ();
    public boolean IsWellFormed1286 ( SpyXMLData1458 oData, boolean bWithChildren );

    // Since version 2004R3
    public SpyAuthenticView1460 GetAuthenticView1270 ();

    // Since version 2004R4
    public SpyApplication1439 GetApplication1269 ();
}

```



```

public SpyDocuments1445 GetParent1287 ();
public String GetFullName1279 ();
public void SetFullName1279 ( String i_strName );
public String GetName1287 ();
public String GetPath1287 ();
public boolean GetSaved1289 ();
public void SaveAs1288 ( String i_strFileNameOrPath );
public String GetEncoding1275 ();
public SpyXMLData1458 GetDataRoot1275 ();
public void GenerateProgramCode1281 ( SpyCodeGeneratorDlg1441 i_dlg );
public void AssignXSLFO1270 ( String i_strFile, boolean i_bUseDialog );
public void TransformXSLFO1293 ();
public void GenerateSchemaDocumentation1282 ( SpySchemaDocumentationDlg1454 i_dlg );

public void ExecuteXQuery1276 ( String i_strXMLSourceFile );
public void SetExternalIsValid1291 ( boolean bIsValid );
public SpyDoc1443 GenerateSampleXML1281 ( SpyGenerateSampleXMLDlg1451 ipGenerateXMLDlg );
public boolean UpdateXMLData1294 ();
public String GetAsXMLString1270 ();
public void SetAsXMLString1270 ( String newVal );
public SpyDoc1443 GeneratedTDOrSchemaEx1280 ( SpyDTDSchemaGeneratorDlg1446
ipDTDSchemaGeneratorDlg );
public SpyDoc1443 ConvertDTDOrSchemaEx1272 ( long1467 nFormat, long1469 nFrequentElements,
String sOutputPath, long1466 nOutputPathDialogAction );
public SpyTextView1457 GetTextView1292 ();
public String[] GetSuggestions1292 ();
public void SetSuggestions1292 ( String[] aList );
public void SetSelection ( String sVal );

// Since version 2009
public void TransformXSLEx1293 ( long1466 nDialogEx );

// Since version 2010r3
public String CreateDBStructureFromXMLSchema1274 ( SpyDatabaseConnection1442 oConnection,
SpyElementList1447 oTables, boolean bDropTableWithExistingName );
public SpyElementList1447 GetDBStructureList1282 ( SpyDatabaseConnection1442 oConnection );
}

```

26.3.5.7 SpyDocuments (obsolete)

The objects described in this section (Application API for Java) are obsolete from v2012 onwards.

For information about how to access the Application API from Java code, see the section: [Programming Languages | Java](#)¹¹⁵⁹.

```

public class SpyDocuments
{

```

```

public void ReleaseInstance1438 ();
public long Count1296 ();
public SpyDoc1443 GetItem1296 ( long nNo );
public SpyDoc1443 NewFile1297 ( String strFile, String strType );
public SpyDoc1443 NewFileFromText1297 ( String nSource, String strType );
public SpyDoc1443 OpenFile1298 ( String sPath, boolean bDialog );
public SpyDoc1443 OpenURL1298 ( String sUrl, long1477 nURLType, long1470 nLoading, String
sUser, String sPassword );
public SpyDoc1443 OpenURLDialog1299 (String sURL, long1477 nURLType, long1470 nLoading, String
sUser, String sPassword );
// Since version 2011r2
public SpyDoc1443 NewAuthenticFile1296 ( String strSPSPath, String strXMLPath );
public SpyDoc1443 OpenAuthenticFile1297 ( String strSPSPath, String strXMLPath );
}

```

26.3.5.8 SpyDTDSchemaGeneratorDlg (obsolete)

The objects described in this section (Application API for Java) are obsolete from v2012 onwards.

For information about how to access the Application API from Java code, see the section: [Programming Languages | Java](#)¹¹⁵⁹.

```

public class SpyDTDSchemaGeneratorDlg
{
public void ReleaseInstance1438 ();
public SpyApplication1439 GetApplication1300 ();
public long1467 GetDTDSchemaFormat1300 ();
public void SetDTDSchemaFormat1300 ( long1467 newVal );
public short GetValueList1303 ();
public void SetValueList1303 ( short newVal );
public long1476 GetTypeDetection1303 ();
public void SetTypeDetection1303 ( long1476 newVal );
public long1469 GetFrequentElements1301 ();
public void SetFrequentElements1301 ( long1469 newVal );
public boolean GetMergeAllEqualNamed1301 ();
public void SetMergeAllEqualNamed1301 ( boolean newVal );
public boolean GetResolveEntities1303 ();
public void SetResolveEntities1303 ( boolean newVal );
public long1463 GetAttributeTypeDefinition1300 ();
public void SetAttributeTypeDefinition1300 ( long1463 newVal );
public boolean GetGlobalAttributes1301 ();
public void SetGlobalAttributes1301 ( boolean newVal );
public boolean GetOnlyStringEnums1302 ();
public void SetOnlyStringEnums1302 ( boolean newVal );
public long GetMaxEnumLength1301 ();
public void SetMaxEnumLength1301 ( long newVal );
public String GetOutputPath1302 ();
}

```

```

public void SetOutputPath1302 ( String newVal );
public long1466 GetOutputPathDialogAction1302 ();
public void SetOutputPathDialogAction1302 ( long1466 newVal );
}

```

26.3.5.9 SpyElementList (obsolete)

The objects described in this section (Application API for Java) are obsolete from v2012 onwards.

For information about how to access the Application API from Java code, see the section: [Programming Languages | Java](#)¹¹⁵⁹.

```

public class SpyElementList
{
    public void ReleaseInstance1438 ();
    public long1304 GetCount1304 ();
    public SpyElementListItem1447 GetItem1304 ( long nIndex );
    public void RemoveElement1304 ( long nIndex );
}

```

26.3.5.10 SpyElementListItem (obsolete)

The objects described in this section (Application API for Java) are obsolete from v2012 onwards.

For information about how to access the Application API from Java code, see the section: [Programming Languages | Java](#)¹¹⁵⁹.

```

public class SpyElementListItem
{
    public void ReleaseInstance1438 ();
    public long1478 GetElementKind1305 ();
    public void SetElementKind1305 ( long1478 nKind );
    public long1305 GetFieldCount1305 ();
    public String GetName1305 ();
    public long1305 GetRecordCount1305 ();
}

```

26.3.5.11 SpyExportSettings (obsolete)

The objects described in this section (Application API for Java) are obsolete from v2012 onwards.

For information about how to access the Application API from Java code, see the section: [Programming Languages | Java](#)¹¹⁵⁹.

```
public class SpyExportSettings
{
    public void ReleaseInstance1436 ();
    public boolean GetCreateKeys1306 ();
    public void SetCreateKeys1306 ( boolean bValue );
    public SpyElementList1447 GetElementList1306 ();
    public void SetElementList1306 ( SpyElementList1447 obj );
    public boolean GetEntitiesToText1307 ();
    public void SetEntitiesToText1307 ( boolean bValue );
    public boolean GetExportAllElements1307 ();
    public void SetExportAllElements1307 ( boolean bValue );
    public boolean GetFromAttributes1307 ();
    public void SetFromAttributes1307 ( boolean bValue );
    public boolean GetFromSingleSubElements1307 ();
    public void SetFromSingleSubElements1307 ( boolean bValue );
    public boolean GetFromTextValues1307 ();
    public void SetFromTextValues1307 ( boolean bValue );
    public boolean GetIndependentPrimaryKey1308 ();
    public void SetIndependentPrimaryKey1308 ( boolean bValue );
    public long1468 GetNamespace1308 ();
    public void SetNamespace1308 ( long1468 nValue );
    public int GetSubLevelLimit1308 ();
    public void SetSubLevelLimit1308 ( int nValue );
}
```

26.3.5.12 SpyFileSelectionDlg (obsolete)

The objects described in this section (Application API for Java) are obsolete from v2012 onwards.

For information about how to access the Application API from Java code, see the section: [Programming Languages | Java](#)¹¹⁵⁹.

```
// Since version 2004R4
```

```
public class SpyFileSelectionDlg
{
    public void ReleaseInstance1438 ();
    public SpyApplication1439 GetApplication1309 ();
    public SpyDialogs1443 GetParent1310 ();
    public String GetFullName1309 ();
    public void SetFullName1309 ( String i_strName );
    public long1466 GetDialogAction1309 ();
    public void SetDialogAction1309 ( long1466 i_eAction );
}
```

26.3.5.13 SpyFindInFilesDlg (obsolete)

The objects described in this section (Application API for Java) are obsolete from v2012 onwards.

For information about how to access the Application API from Java code, see the section: [Programming Languages | Java](#)¹¹⁵⁹.

```
public class SpyFindInFilesDlg
{
    public void ReleaseInstance1438 ();
    public SpyApplication1439 GetApplication1311 ();
    public String GetFind1312 ();
    public void SetFind1312 ( String sNewVal );
    public boolean GetRegularExpression1313 ();
    public void SetRegularExpression1313 ( boolean bNewVal );
    public String GetReplace1313 ();
    public void SetReplace1313 ( String sNewVal );
    public boolean GetReplaceOnDisk1313 ();
    public void SetReplaceOnDisk1313 ( boolean bNewVal );
    public boolean GetDoReplace1311 ();
    public void SetDoReplace1311 ( boolean bNewVal );
    public boolean GetMatchWholeWord1312 ();
    public void SetMatchWholeWord1312 ( boolean bNewVal );
    public boolean GetMatchCase1312 ();
    public void SetMatchCase1312 ( boolean bNewVal );
    public long1463 GetSearchLocation1314 ();
    public void SetSearchLocation1314 ( long1468 nPosition );
    public String GetStartFolder1315 ();
    public void SetStartFolder1315 ( String sNewVal );
    public boolean GetIncludeSubfolders1312 ();
    public void SetIncludeSubfolders1312 ( boolean bNewVal );
    public boolean GetSearchInProjectFilesDoExternal1314 ();
    public void SetSearchInProjectFilesDoExternal1314 ( boolean bNewVal );
    public String GetFileExtension1311 ();
    public void SetFileExtension1311 ( String sNewVal );
    public boolean GetAdvancedXMLSearch1311 ();
}
```

```

public void SetAdvancedXMLSearch1311 ( boolean bNewVal );
public boolean GetXMLElementNames1316 ();
public void SetXMLElementNames1316 ( boolean bNewVal );
public boolean GetXMLElementContents1316 ();
public void SetXMLElementContents1316 ( boolean bNewVal );
public boolean GetXMLElementAttributeNames1315 ();
public void SetXMLElementAttributeNames1315 ( boolean bNewVal );
public boolean GetXMLElementAttributeContents1315 ();
public void SetXMLElementAttributeContents1315 ( boolean bNewVal );
public boolean GetXMLElements1316 ();
public void SetXMLElements1316 ( boolean bNewVal );
public boolean GetXMLELData1315 ();
public void SetXMLElementData1315 ( boolean bNewVal );
public boolean GetXMLELPI1316 ();
public void SetXMLElementPI1316 ( boolean bNewVal );
public boolean GetXMLELRest1317 ();
public void SetXMLElementRest1317 ( boolean bNewVal );
public boolean GetXMLELShowResult1314 ();
public void SetXMLElementShowResult1314 ( boolean bNewVal );
}

```

26.3.5.14 SpyFindInFilesMatch (obsolete)

The objects described in this section (Application API for Java) are obsolete from v2012 onwards.

For information about how to access the Application API from Java code, see the section: [Programming Languages | Java](#)¹¹⁵⁹.

```

public class SpyFindInFilesMatch
{
    public void ReleaseInstance1438 ();
    public long Line1320 ();
    public long Position1320 ();
    public long Length1319 ();
    public String LineText1320 ();
    public boolean Replaced1321 ();
}

```

26.3.5.15 SpyFindInFilesResult (obsolete)

The objects described in this section (Application API for Java) are obsolete from v2012 onwards.

For information about how to access the Application API from Java code, see the section: [Programming Languages | Java](#)¹¹⁵⁹.

```
public class SpyFindInFilesResult
{
    public void ReleaseInstance1438 ();
    public long Count1318 ();
    public SpyFindInFilesMatch1450 GetItem1318 ( long nNo );
    public String GetPath1318 ();
    public SpyDoc1443 GetDocument1318 ();
}
```

26.3.5.16 SpyFindInFilesResults (obsolete)

The objects described in this section (Application API for Java) are obsolete from v2012 onwards.

For information about how to access the Application API from Java code, see the section: [Programming Languages | Java](#)¹¹⁵⁹.

```
public class SpyFindInFilesResults
{
    public void ReleaseInstance1438 ();
    public long Count1322 ();
    public SpyFindInFilesResult1450 GetItem1322 ( long nNo );
}
```

26.3.5.17 SpyGenerateSampleXMLDlg (obsolete)

The objects described in this section (Application API for Java) are obsolete from v2012 onwards.

For information about how to access the Application API from Java code, see the section: [Programming Languages | Java](#)¹¹⁵⁹.

```
public class SpyGenerateSampleXMLDlg
{
    public void ReleaseInstance1438 ();
    public SpyApplication1439 GetApplication1323 ();
    public boolean GetNonMandatoryAttributes1325 ();
}
```

```

public void SetNonMandatoryAttributes1325 ( boolean newVal );
public boolean GetNonMandatoryElements1325 ();
public void SetNonMandatoryElements1325 ( boolean newVal );
public boolean GetTakeFirstChoice1327 ();
public void SetTakeFirstChoice1327 ( boolean newVal );
public long GetRepeatCount1327 ();
public void SetRepeatCount1327 ( long newVal );
public boolean GetFillWithSampleData1324 ();
public void SetFillWithSampleData1324 ( boolean newVal );
public boolean GetFillElementsWithSampleData1324 ();
public void SetFillElementsWithSampleData1324 ( boolean newVal );
public boolean GetFillAttributesWithSampleData1324 ();
public void SetFillAttributesWithSampleData1324 ( boolean newVal );
public boolean GetContentOfNillableElementsIsNonMandatory1324 ();
public void SetContentOfNillableElementsIsNonMandatory1324 ( boolean newVal );
public boolean GetTryToUseNonAbstractTypes1328 ();
public void SetTryToUseNonAbstractTypes1328 ( boolean newVal );
public long1472 GetOptimization1326 ();
public void SetOptimization1326 ( long1472 newVal );
public long1473 GetSchemaOrDTDAssignment1327 ();
public void SetSchemaOrDTDAssignment1327 ( long1473 newVal );
public String GetLocalNameOfRootElement1325 ();
public void SetLocalNameOfRootElement1325 ( String newVal );
public String GetNamespaceURIOfRootElement1325 ();
public void SetNamespaceURIOfRootElement1325 ( String newVal );
public long1466 GetOptionsDialogAction1326 ();
public void SetOptionsDialogAction1326 ( long1466 newVal );
}

```

26.3.5.18 SpyGridView (obsolete)

The objects described in this section (Application API for Java) are obsolete from v2012 onwards.

For information about how to access the Application API from Java code, see the section: [Programming Languages | Java](#)¹¹⁵⁹.

```

public class SpyGridView
{
    public void ReleaseInstance1438 ();
    public SpyXMLData1458 GetCurrentFocus1331 ();
    public void Deselect1331 ( SpyXMLData1458 oData );
    public boolean GetIsVisible1331 ();
    public void Select1331 ( SpyXMLData1458 oData );
    public void SetFocus1331 ( SpyXMLData1458 oData );
}

```

26.3.5.19 SpyProject (obsolete)

The objects described in this section (Application API for Java) are obsolete from v2012 onwards.

For information about how to access the Application API from Java code, see the section: [Programming Languages | Java](#)¹¹⁵⁹.

```
public class SpyProject
{
    public void ReleaseInstance1438 ();
    public void CloseProject1359 ( boolean bDiscardChanges, boolean bCloseFiles, boolean bDialog );
    public String GetProjectFile1360 ();
    public void SetProjectFile1360 ( String sFile );
    public SpyProjectItems1454 GetRootItems1360 ();
    public void SaveProject1360 ();
    public void SaveProjectAs1360 ( String sPath, boolean bDialog );
}
```

26.3.5.20 SpyProjectItem (obsolete)

The objects described in this section (Application API for Java) are obsolete from v2012 onwards.

For information about how to access the Application API from Java code, see the section: [Programming Languages | Java](#)¹¹⁵⁹.

```
public class SpyProjectItem
{
    public void ReleaseInstance1438 ();
    public SpyProjectItems1454 GetChildItems1361 ();
    public String GetFileExtensions1361 ();
    public void SetFileExtensions1361 ( String sExtensions );
    public long1471 GetItemType1361 ();
    public String GetName1361 ();
    public SpyDoc1443 Open1361 ();
    public SpyProjectItem1453 GetParentItem1362 ();
    public String GetPath1362 ();
    public String GetValidateWith1362 ();
    public void SetValidateWith1362 ( String sVal );
    public String GetXMLForXSLTransformation1362 ();
}
```

```

public void SetXMLForXSLTransformation1362 ( String sVal );
public String GetXSLForXMLTransformation1362 ();
public void SetXSLForXMLTransformation1362 ( String sVal );
public String GetXSLTransformationFileExtension1362 ();
public void SetXSLTransformationFileExtension1362 ( String sVal );
public String GetXSLTransformationFolder1363 ();
public void SetXSLTransformationFolder1363 ( String sVal );
}

```

26.3.5.21 SpyProjectItems (obsolete)

The objects described in this section (Application API for Java) are obsolete from v2012 onwards.

For information about how to access the Application API from Java code, see the section: [Programming Languages | Java](#)¹¹⁵⁹.

```

public class SpyProjectItems
{
    public void ReleaseInstance1438 ();
    public void AddFile1363 ( String sPath );
    public void AddFolder1363 ( String sName );
    public void AddURL1364 ( String sURL, long1477 nURLType, String sUser, String sPassword,
    boolean bSave );
    public long1364 Count1364 ();
    public SpyProjectItem1453 GetItem1364 ( long nNumber );
    public void RemoveItem1364 ( SpyProjectItem1453 oItemToRemove );
}

```

26.3.5.22 SpySchemaDocumentationDlg (obsolete)

The objects described in this section (Application API for Java) are obsolete from v2012 onwards.

For information about how to access the Application API from Java code, see the section: [Programming Languages | Java](#)¹¹⁵⁹.

```

// Since version 2004R4
public class SpySchemaDocumentationDlg
{
    public void ReleaseInstance1438 ();
    public SpyApplication1439 GetApplication1346 ();
}

```

```

public SpyDialogs1443 GetParent1353 ();

public String GetOutputFile1352 ();
public void SetOutputFile1352 ( String i_strVal );
public long1474 GetOutputFormat1353 ();
public void SetOutputFormat1353 ( long1474 i_eVal );

public boolean GetShowResult1357 ();
public void SetShowResult1357 ( boolean i_bVal );
public long1466 GetOptionsDialogAction1352 ();
public void SetOptionsDialogAction1352 ( long1466 i_eVal );
public long1466 GetOutputFileDialogAction1353 ();
public void SetOutputFileDialogAction1353 ( long1466 i_eVal );
public boolean GetShowProgressBar1356 ();
public void SetShowProgressBar1356 ( boolean i_bVal );

public void IncludeAll1348 ( boolean i_bInclude );
public boolean GetIncludeIndex1350 ();
public void SetIncludeIndex1350 ( boolean i_bVal );
public boolean GetIncludeGlobalElements1349 ();
public void SetIncludeGlobalElements1348 ( boolean i_bVal );
public boolean GetIncludeLocalElements1351 ();
public void SetIncludeLocalElements1351 ( boolean i_bVal );
public boolean GetIncludeGroups1350 ();
public void SetIncludeGroups1350 ( boolean i_bVal );
public boolean GetIncludeComplexTypes1349 ();
public void SetIncludeComplexTypes1349 ( boolean i_bVal );
public boolean GetIncludeSimpleTypes1351 ();
public void SetIncludeSimpleTypes1351 ( boolean i_bVal );
public boolean GetIncludeAttributeGroups1348 ();
public void SetIncludeAttributeGroups1348 ( boolean i_bVal );
public boolean GetIncludeRedefines1351 ();
public void SetIncludeRedefines1351 ( boolean i_bVal );

public void AllDetails1346 ( boolean i_bDetailsOn );
public boolean GetShowDiagram1355 ();
public void SetShowDiagram1355 ( boolean i_bVal );
public boolean GetShowNamespace1356 ();
public void SetShowNamespace1356 ( boolean i_bVal );
public boolean GetShowType1358 ();
public void SetShowType1358 ( boolean i_bVal );
public boolean GetShowChildren1354 ();
public void SetShowChildren1354 ( boolean i_bVal );
public boolean GetShowUsedBy1358 ();
public void SetShowUsedBy1358 ( boolean i_bVal );
public boolean GetShowProperties1356 ();
public void SetShowProperties1356 ( boolean i_bVal );
public boolean GetShowSingleFacets1357 ();
public void SetShowSingleFacets1357 ( boolean i_bVal );
public boolean GetShowPatterns1356 ();

```

```

public void SetShowPatterns1356 ( boolean i_bVal );
public boolean GetShowEnumerations1355 ();
public void SetShowEnumerations1355 ( boolean i_bVal );
public boolean GetShowAttributes1354 ();
public void SetShowAttributes1354 ( boolean i_bVal );
public boolean GetShowIdentityConstraints1355 ();
public void SetShowIdentityConstraints1355 ( boolean i_bVal );
public boolean GetShowAnnotations1354 ();
public void SetShowAnnotations1354 ( boolean i_bVal );
public boolean GetShowSourceCode1357 ();
public void SetShowSourceCode1357 ( boolean i_bVal );

// Since version 2009
public boolean GetEmbedDiagrams1348 ();
public void SetEmbedDiagrams1348 ( boolean i_bVal );
public long GetDiagramFormat14691347 ();
public void SetDiagramFormat1347 ( long 1469 i_nVal );
public boolean GetIncludeGlobalAttributes1349 ();
public void SetIncludeGlobalAttributes1349 ( boolean i_bVal );
public boolean GetIncludeLocalAttributes1350 ();
public void SetIncludeLocalAttributes1350 ( boolean i_bVal );
public boolean GetIncludeReferencedSchemas1351 ();
public void SetIncludeReferencedSchemas1351 ( boolean i_bVal );
public boolean GetMultipleOutputFiles1352 ();
public void SetMultipleOutputFiles1352 ( boolean i_bVal );

// Since version 2010
public boolean GetEmbedCSSInHTML1347 ();
public void SetEmbedCSSInHTML1347 ( boolean i_bVal );
public boolean GetCreateDiagramsFolder1347 ();
public void SetCreateDiagramsFolder1347 ( boolean i_bVal );

// Since version 2010r3
public boolean GetGenerateRelativeLinks1348 ();
public void SetGenerateRelativeLinks1348 ( boolean i_bVal );

// Since version 2011r2
public boolean GetUseFixedDesign1359 ();
public void SetUseFixedDesign1359 ( boolean i_bVal );
public String GetSPSFile1358 ();
public void SetSPSFile1358 ( String i_strVal );
}

```

26.3.5.23 SpyTextImportExportSettings (obsolete)

The objects described in this section (Application API for Java) are obsolete from v2012 onwards.

For information about how to access the Application API from Java code, see the section: [Programming Languages | Java](#)¹¹⁵⁹.

```
public class SpyTextImportExportSettings
{
    public void ReleaseInstance1438 ();
    public String GetDestinationFolder1365 ();
    public void SetDestinationFolder1365 ( String sVal );
    public long GetEnclosingCharacter1365 ();
    public void SetEnclosingCharacter1365 ( long1476 nEnclosing );
    public String GetEncoding1366 ();
    public void SetEncoding1366 ( String sVal );
    public long GetEncodingByteOrder1366 ();
    public void SetEncodingByteOrder1366 ( long1468 nByteOrder );
    public long GetFieldDelimiter1366 ();
    public void SetFieldDelimiter1366 ( long1475 nDelimiter );
    public String GetFileExtension1366 ();
    public void SetFileExtension1366 ( String sVal );
    public boolean GetHeaderRow1366 ();
    public void SetHeaderRow1366 ( boolean bVal );
    public String GetImportFile1366 ();
    public void SetImportFile1366 ( String sVal );
}
```

26.3.5.24 SpyTextView (obsolete)

```
public class SpyTextView
{
    public void ReleaseInstance1438 ();
    public SpyApplication GetApplication1369 ();
    public SpyDoc GetParent1371 ();
    public long LineFromPosition1370 ( long nCharPos );
    public long PositionFromLine1371 ( long nLine );
    public long LineLength1370 ( long nLine );
    public String GetSelText1372 ();
    public void SetSelText1372 ( String sText );
    public String GetRangeText1369 ( long nPosFrom, long nPosTill );
    public void ReplaceText1371 ( long nPosFrom, long nPosTill, String sText );
    public void MoveCaret1371 ( long nDiff );
    public void GoToLineChar1369 ( long nLine, long nChar );
}
```

```

public void SelectText1372 ( long nPosFrom, long nPosTill );
public long GetSelectionStart1372 ();
public void SetSelectionStart1372 ( long nNewVal );
public long GetSelectionEnd1372 ();
public void SetSelectionEnd1372 ( long nNewVal );
public String GetText1373 ();
public void SetText1373 ( String sText );
public long LineCount1370 ();
public long Length1370 ();
}

```

26.3.5.25 SpyXMLData (obsolete)

The objects described in this section (Application API for Java) are obsolete from v2012 onwards.

For information about how to access the Application API from Java code, see the section: [Programming Languages | Java](#)¹¹⁵⁹.

```

public class SpyXMLData
{
    public void ReleaseInstance1438 ();
    public void AppendChild1374 ( SpyXMLData1458 oNewData );
    public void EraseAllChildren1375 ();
    public void EraseCurrentChild1376 ();
    public SpyXMLData1458 GetCurrentChild1378 ();
    public SpyXMLData1458 GetFirstChild1379 ( long nKind );
    public SpyXMLData1458 GetNextChild1380 ();
    public boolean GetHasChildren1381 ();
    public void InsertChild1382 ( SpyXMLData1458 oNewData );
    public boolean IsSameNode1383 ( SpyXMLData1458 oToComp );
    public long GetKind1383 ();
    public boolean GetMayHaveChildren1384 ();
    public String GetName1384 ();
    public void SetName1384 ( String sValue );
    public SpyXMLData1458 GetParent1384 ();
    public String GetTextValue1385 ();
    public void SetTextValue1385 ( String sValue );
}

```

26.3.5.26 Authentic (obsolete)

26.3.5.26.1 SpyAuthenticRange (obsolete)

The objects described in this section (Application API for Java) are obsolete from v2012 onwards.

For information about how to access the Application API from Java code, see the section: [Programming Languages | Java](#).

```
// Since version 2004R3
public class SpyAuthenticRange
{
    public void ReleaseInstance ();
    public SpyApplication GetApplication ();
    public SpyAuthenticView GetParent ();
    public SpyAuthenticRange GotoNext ( long eKind );
    public SpyAuthenticRange GotoPrevious ( long eKind );
    public void Select ();
    public long GetFirstTextPosition ();
    public void SetFirstTextPosition ( long nTextPosition );
    public long GetLastTextPosition ();
    public void SetLastTextPosition ( long nTextPosition );
    public String GetText ();
    public void SetText ( String strText );
    public boolean PerformAction ( long eAction, String strElementName );
    public boolean CanPerformAction ( long eAction, String strElementName );
    public String[] CanPerformActionWith ( long eAction );
    public SpyAuthenticRange GoTo ( long eKind, long nCount, long nFrom );
    public SpyAuthenticRange SelectNext ( long eKind );
    public SpyAuthenticRange SelectPrevious ( long eKind );
    public SpyAuthenticRange MoveBegin ( long eKind, long nCount );
    public SpyAuthenticRange MoveEnd ( long eKind, long nCount );
    public SpyAuthenticRange ExpandTo ( long eKind );
    public SpyAuthenticRange CollapsToBegin ();
    public SpyAuthenticRange CollapsToEnd ();
    public SpyAuthenticRange GotoNextCursorPosition ();
    public SpyAuthenticRange GotoPreviousCursorPosition ();
    public boolean IsEmpty ();
    public boolean IsEqual ( SpyAuthenticRange ipCmp );
    public SpyAuthenticRange Clone ();
    public SpyAuthenticRange SetFromRange ( SpyAuthenticRange ipSrc );
    public boolean Delete ();
    public boolean Cut ();
    public boolean Copy ();
    public boolean Paste ();
}
```

```

public SpyXMLData GetFirstXMLData1207 ();
public void SetFirstXMLData1207 ( SpyXMLData 1458 objXMLDataPtr );
public long GetFirstXMLDataOffset1208 ();
public void SetFirstXMLDataOffset1208 ( long nOffset );
public SpyXMLData GetLastXMLData1220 ();
public void SetLastXMLData1220 ( SpyXMLData 1477 objXMLDataPtr );
public long GetLastXMLDataOffset1221 ();
public void SetLastXMLDataOffset1221 ( long nOffset );
public String[] GetElementHierarchy1210 ();
public String[] GetElementAttributeNames1209 ( String strElementName );
public boolean HasElementAttribute1215 ( String strElementName, String
strAttributeName );
public String GetElementAttributeValue1210 ( String strElementName, String
strAttributeName );
public void SetElementAttributeValue1227 ( String strElementName, String
strAttributeName, String strNewValue );
public String[] GetEntityNames1211 ();
public void InsertEntity1215 ( String strEntityName );
public boolean IsInDynamicTable1218 ();
public boolean AppendRow1201 ();
public boolean InsertRow1216 ();
public boolean DuplicateRow1205 ();
public boolean DeleteRow1205 ();
public boolean MoveRowUp1223 ();
public boolean MoveRowDown1223 ();

// Since version 2004R4
public boolean IsCopyEnabled1216 ();
public boolean IsCutEnabled1217 ();
public boolean IsPasteEnabled1218 ();
public boolean IsDeleteEnabled1217 ();
public boolean IsTextStateApplied1219 ( String i_strElementName );
public boolean IsFirstRow1218 ();
public boolean IsLastRow1218 ();
}

```

26.3.5.26.2 SpyAuthenticView (obsolete)

The objects described in this section (Application API for Java) are obsolete from v2012 onwards.

For information about how to access the Application API from Java code, see the section: [Programming Languages | Java](#)¹¹⁵⁹.

```

// Since version 2004R3
public class SpyAuthenticView
{
public void ReleaseInstance1438 ();
}

```



```

public SpyApplication1439 GetApplication1239 ();
public SpyDoc1443 GetParent1245 ();
public SpyAuthenticRange1459 GetSelection1246 ();
public void SetSelection1246 ( SpyAuthenticRange1459 obj );
public SpyAuthenticRange1459 GetDocumentBegin1241 ();
public SpyAuthenticRange1459 GetDocumentEnd1241 ();
public SpyAuthenticRange1459 GetWholeDocument1248 ();
public long1465 GetMarkupVisibility1245 ();
public void SetMarkupVisibility1245 ( long1465 eSpyAuthenticMarkupVisibility );
public SpyAuthenticRange1459 GoTo1243 ( long1465 eKind, long nCount, long1464 nFrom );
public void Print1245 ( boolean bWithPreview, boolean bPromptUser );
public boolean Undo1247 ();
public boolean Redo1246 ();
public void UpdateXMLInstanceEntities1247 ();

// Since version 2004R4
public String GetAsXMLString1239 ();
public void SetAsXMLString1239 ( String i_strXML );
public SpyXMLData1458 GetXMLDataRoot1248 ();
public boolean IsUndoEnabled1244 ();
public boolean IsRedoEnabled1222 ();
}

```

26.3.5.26.3 [SpyDocEditSelection](#) (obsolete)

The objects described in this section (Application API for Java) are obsolete from v2012 onwards.

For information about how to access the Application API from Java code, see the section: [Programming Languages | Java](#)¹¹⁵⁹.

```

public class SpyDocEditSelection
{
    public void ReleaseInstance1438 ();
    public SpyXMLData1458 GetEnd1398 ();
    public long GetEndTextPosition1399 ();
    public SpyXMLData1458 GetStart1399 ();
    public long GetStartTextPosition1399 ();
}

```

26.3.5.26.4 [SpyDocEditView](#) (obsolete)

The objects described in this section (Application API for Java) are obsolete from v2012 onwards.

For information about how to access the Application API from Java code, see the section: [Programming Languages | Java](#)¹¹⁵⁹.

```

public class SpyDocEditView
{
    public void ReleaseInstance1438 ();
    public void ApplyTextState1401 ( String sElementName );
    public SpyDocEditSelection1461 GetCurrentSelection1402 ();
    public void EditClear1402 ();
    public void EditCopy1403 ();
    public void EditCut1403 ();
    public void EditPaste1404 ();
    public void EditRedo1404 ();
    public void EditSelectAll1405 ();
    public void EditUndo1405 ();
    public SpyXMLData1458 GetNextVisible1408 ( SpyXMLData1458 oElement );
    public SpyXMLData1458 GetPreviousVisible1408 ( SpyXMLData1458 oElement );
    public boolean GetIsEditClearEnabled1409 ();
    public boolean GetIsEditCopyEnabled1410 ();
    public boolean GetIsEditCutEnabled1410 ();
    public boolean GetIsEditPasteEnabled1411 ();
    public boolean GetIsEditRedoEnabled1411 ();
    public boolean GetIsEditUndoEnabled1412 ();
    public boolean GetIsRowAppendEnabled1412 ();
    public boolean GetIsRowDeleteEnabled1413 ();
    public boolean GetIsRowDuplicateEnabled1413 ();
    public boolean GetIsRowInsertEnabled1414 ();
    public boolean GetIsRowMoveDownEnabled1414 ();
    public boolean GetIsRowMoveUpEnabled1414 ();
    public boolean IsTextStateApplied1415 ( String sElementName );
    public boolean IsTextStateEnabled1415 ( String sElementName );
    public void LoadXML1416 ( String sXML );
    public void MarkUpView1416 ( long nKind );
    public void RowAppend1417 ();
    public void RowDelete1417 ();
    public void RowDuplicate1418 ();
    public void RowInsert1418 ();
    public void RowMoveDown1419 ();
    public void RowMoveUp1419 ();
    public String SaveXML1420 ();
    public void SelectionMoveTabOrder1421 ( boolean bForward, boolean bTag );
    public boolean SelectionSet1421 ( SpyXMLData1458 oStart, long nStartPos, SpyXMLData1458
oEndElement, long nEndPos );
    public SpyXMLData1458 GetXMLRoot1422 ();
    public String[] GetAllowedElements1406 ( long nAction, SpyXMLData1458 oStartPtr,
SpyXMLData1458 oEndPtr );
}

```

26.3.5.27 Predefined constants (obsolete)

The objects described in this section (Application API for Java) are obsolete from v2012 onwards.

For information about how to access the Application API from Java code, see the section: [Programming Languages | Java](#)¹¹⁵⁹.

This section lists all classes that define the predefined constants used by the Java interface.

26.3.5.27.1 SPYApplicationStatus (obsolete)

The objects described in this section (Application API for Java) are obsolete from v2012 onwards.

For information about how to access the Application API from Java code, see the section: [Programming Languages | Java](#)¹¹⁵⁹.

```
public class SPYApplicationStatus
{
    public final static long spyApplicationStatus_Running           = 0;
    public final static long spyApplicationStatus_AfterLicenseCheck = 1;
    public final static long spyApplicationStatus_BeforeLicenseCheck = 2;
    public final static long spyApplicationStatus_ConcurrentLicenseCheckFailed = 3;
    public final static long spyApplicationStatus_ProcessingCommandLine = 4;
}
```

26.3.5.27.2 SPYAttributeTypeDefinition (obsolete)

The objects described in this section (Application API for Java) are obsolete from v2012 onwards.

For information about how to access the Application API from Java code, see the section: [Programming Languages | Java](#)¹¹⁵⁹.

```
public class SPYAttributeTypeDefinition
{
```

```

    public final static long          = 0;
    spyMergedGlobal
    public final static long          = 1;
    spyDistinctGlobal
    public final static long spyLocal = 2;
}

```

26.3.5.27.3 SPYAuthenticActions (obsolete)

The objects described in this section (Application API for Java) are obsolete from v2012 onwards.

For information about how to access the Application API from Java code, see the section: [Programming Languages | Java](#)¹¹⁵⁹.

```

public class SPYAuthenticActions
{
    public final static long spyAuthenticInsertAt = 0;
    public final static long spyAuthenticApply   = 1;
    public final static long spyAuthenticClearSurr = 2;
    public final static long spyAuthenticAppend  = 3;
    public final static long spyAuthenticInsertBefore = 4;
    public final static long spyAuthenticRemove   = 5;
}

```

26.3.5.27.4 SPYAuthenticDocumentPosition (obsolete)

The objects described in this section (Application API for Java) are obsolete from v2012 onwards.

For information about how to access the Application API from Java code, see the section: [Programming Languages | Java](#)¹¹⁵⁹.

```

public class SPYAuthenticDocumentPosition
{
    public final static long spyAuthenticDocumentBegin = 0;
    public final static long spyAuthenticDocumentEnd   = 1;
    public final static long spyAuthenticRangeBegin    = 2;
}

```

```
    public final static long spyAuthenticRangeEnd = 3;
}
```

26.3.5.27.5 SPYAuthenticElementKind (obsolete)

The objects described in this section (Application API for Java) are obsolete from v2012 onwards.

For information about how to access the Application API from Java code, see the section: [Programming Languages | Java](#)¹¹⁵⁹.

```
public class SPYAuthenticElementKind
{
    public final static long spyAuthenticChar = 0;
    public final static long spyAuthenticWord = 1;
    public final static long spyAuthenticLine = 3;
    public final static long spyAuthenticParagraph = 4;
    public final static long spyAuthenticTag = 6;
    public final static long spyAuthenticDocument = 8;
    public final static long spyAuthenticTable = 9;
    public final static long spyAuthenticTableRow = 10;
    public final static long spyAuthenticTableColumn = 11;
}
```

26.3.5.27.6 SPYAuthenticMarkupVisibility (obsolete)

The objects described in this section (Application API for Java) are obsolete from v2012 onwards.

For information about how to access the Application API from Java code, see the section: [Programming Languages | Java](#)¹¹⁵⁹.

```
public class SPYAuthenticMarkupVisibility
{
    public final static long          = 0;
    spyAuthenticMarkupHidden
    public final static long spyAuthenticMarkupSmall= 1;
    public final static long spyAuthenticMarkupLarge= 2;
    public final static long spyAuthenticMarkupMixed= 3;
}
```

26.3.5.27.7 SPYDatabaseKind (obsolete)

The objects described in this section (Application API for Java) are obsolete from v2012 onwards.

For information about how to access the Application API from Java code, see the section: [Programming Languages | Java](#)¹¹⁵⁹.

```
public class SPYLoading
{
    public final static long spyDB_Access      = 0;
    public final static long          = 1;
    spyDB_SQLServer
    public final static long spyDB_Oracle     = 2;
    public final static long spyDB_Sybase    = 3;
    public final static long spyDB_MySQL     = 4;
    public final static long spyDB_DB2      = 5;
    public final static long spyDB_Other     = 6;
    public final static long          = 7;
    spyDB_Unspecified
}
```

26.3.5.27.8 SPYDialogAction (obsolete)

The objects described in this section (Application API for Java) are obsolete from v2012 onwards.

For information about how to access the Application API from Java code, see the section: [Programming Languages | Java](#)¹¹⁵⁹.

```
public class SPYDialogAction
{
```

```

    public final static long spyDialogOK      = 0;
    public final static long spyDialogCancel
    public final static long spyDialogUserInput = 2;
}

```

26.3.5.27.9 SPYDOMType (obsolete)

The objects described in this section (Application API for Java) are obsolete from v2012 onwards.

For information about how to access the Application API from Java code, see the section: [Programming Languages | Java](#)¹¹⁵⁹.

```

public class SPYDOMType
{
    public final static long spyDOMType_msxml4      = 0;
    public final static long spyDOMType_xerces     = 1;
}

```

26.3.5.27.10 SPYDTDSchemaFormat (obsolete)

The objects described in this section (Application API for Java) are obsolete from v2012 onwards.

For information about how to access the Application API from Java code, see the section: [Programming Languages | Java](#)¹¹⁵⁹.

```

public class SPYDTDSchemaFormat
{
    public final static long spyDTD      = 0;
    public final static long spyDCD     = 1;
    public final static long spyXMLData = 2;
    public final static long spyBizTalk = 3;
    public final static long spyW3C    = 4;
}

```

26.3.5.27.11 SPYEncodingByteOrder (obsolete)

The objects described in this section (Application API for Java) are obsolete from v2012 onwards.

For information about how to access the Application API from Java code, see the section: [Programming Languages | Java](#)¹¹⁵⁹.

```
public class SPYEncodingByteOrder
{
    public final static long spyNONE           = 0;
    public final static long spyLITTLE_ENDIAN = 1;
    public final static long spyBIG_ENDIAN    = 2;
}
```

26.3.5.27.12 SPYExportNamespace (obsolete)

The objects described in this section (Application API for Java) are obsolete from v2012 onwards.

For information about how to access the Application API from Java code, see the section: [Programming Languages | Java](#)¹¹⁵⁹.

```
public class SPYExportNamespace
{
    public final static long spyNoNamespace           = 0;
    public final static long spyReplaceColonWithUnderscore = 1;
}
```

26.3.5.27.13 SPYFindInFilesSearchLocation (obsolete)

The objects described in this section (Application API for Java) are obsolete from v2012 onwards.

For information about how to access the Application API from Java code, see the section: [Programming Languages | Java](#)¹¹⁵⁹.

```
public class SPYFindInFilesSearchLocation
{
    public final static long          = 0;
    spyFindInFiles_Documents
    public final static long          = 1;
    spyFindInFiles_Project
    public final static long          = 2;
    spyFindInFiles_Folder
}
```

26.3.5.27.14 SPYFrequentElements (obsolete)

The objects described in this section (Application API for Java) are obsolete from v2012 onwards.

For information about how to access the Application API from Java code, see the section: [Programming Languages | Java](#)¹¹⁵⁹.

```
public class SPYFrequentElements
{
    public final static long          = 0;
    spyGlobalElements
    public final static long          = 1;
    spyGlobalComplexType
}
```

26.3.5.27.15 SPYImageKind (obsolete)

The objects described in this section (Application API for Java) are obsolete from v2012 onwards.

For information about how to access the Application API from Java code, see the section: [Programming Languages | Java](#)¹¹⁵⁹.

```
public class SPYImageKind
{
    public final static long          = 0;
    spyImageType_PNG
    public final static long          = 1;
    spyImageType_EMF
}
```

26.3.5.27.16 SPYImportColumnsType (obsolete)

The objects described in this section (Application API for Java) are obsolete from v2012 onwards.

For information about how to access the Application API from Java code, see the section: [Programming Languages | Java](#)¹¹⁵⁹.

26.3.5.27.17 SPYLibType (obsolete)

The objects described in this section (Application API for Java) are obsolete from v2012 onwards.

For information about how to access the Application API from Java code, see the section: [Programming Languages | Java](#)¹¹⁵⁹.

```
public class SPYLibType
{
    public final static long          = 0;
    spyLibType_static
    public final static long spyLibType_dll= 1;
}
```

26.3.5.27.18 SPYLoading (obsolete)

The objects described in this section (Application API for Java) are obsolete from v2012 onwards.

For information about how to access the Application API from Java code, see the section: [Programming Languages | Java](#)¹¹⁵⁹.

```
public class SPYLoading
{
    public final static long          = 0;
    spyUseCacheProxy
    public final static long spyReload = 1;
}
```

```
}
```

26.3.5.27.19 SPYNumberDateTimeFormat (obsolete)

The objects described in this section (Application API for Java) are obsolete from v2012 onwards.

For information about how to access the Application API from Java code, see the section: [Programming Languages | Java¹¹⁵⁹](#).

```
public class SPYNumberDateTimeFormat
{
    public final static long spySystemLocale = 0;
    public final static long          = 1;
    spySchemaCompatible
}
```

26.3.5.27.20 SPYProgrammingLanguage (obsolete)

The objects described in this section (Application API for Java) are obsolete from v2012 onwards.

For information about how to access the Application API from Java code, see the section: [Programming Languages | Java¹¹⁵⁹](#).

```
public class SPYLoading
{
    public final static long spyUndefinedLanguage = -1;
    public final static long spyJava             = 0;
    public final static long spyCpp              = 1;
    public final static long spyCSharp          = 2;
}
```

26.3.5.27.21 SPYProjectItemTypes (obsolete)

The objects described in this section (Application API for Java) are obsolete from v2012 onwards.

For information about how to access the Application API from Java code, see the section: [Programming Languages | Java](#)¹¹⁵⁹.

```
public class SPYProjectItemTypes
{
    public final static long          = 0;
    spyUnknownItem
    public final static long spyFileItem= 1;
    public final static long          = 2;
    spyFolderItem
    public final static long spyURLItem = 3;
}
```

26.3.5.27.22 SPYProjectType (obsolete)

The objects described in this section (Application API for Java) are obsolete from v2012 onwards.

For information about how to access the Application API from Java code, see the section: [Programming Languages | Java](#)¹¹⁵⁹.

```
public class SPYProjectType
{
    public final static long          = 0;
    spyVisualStudioProject
    public final static long          = 1;
    spyVisualStudio2003Project
    public final static long spyBorlandProject = 2;
    public final static long spyMonoMakefile  = 3;
}
```

26.3.5.27.23 SPYSampleXMLGenerationOptimization (obsolete)

The objects described in this section (Application API for Java) are obsolete from v2012 onwards.

For information about how to access the Application API from Java code, see the section: [Programming Languages | Java](#)¹¹⁵⁹.

```
public class SPYSampleXMLGenerationOptimization
{
    public final static long spySampleXMLGen_Optimized = 0;
    public final static long
    spySampleXMLGen_NonMandatoryElements
    public final static long spySampleXMLGen_Everything = 2;
}
```

26.3.5.27.24 SPYSampleXMLGenerationSchemaOrDTDAssignment (obsolete)

The objects described in this section (Application API for Java) are obsolete from v2012 onwards.

For information about how to access the Application API from Java code, see the section: [Programming Languages | Java](#)¹¹⁵⁹.

```
public class SPYSampleXMLGenerationOptimization
{
    public final static long
    spySampleXMLGen_AssignRelatively = 0;
    public final static long
    spySampleXMLGen_AssignAbsolutely = 1;
    public final static long spySampleXMLGen_DoNotAssign = 2;
}
```

26.3.5.27.25 SPYSchemaDefKind (obsolete)

The objects described in this section (Application API for Java) are obsolete from v2012 onwards.

For information about how to access the Application API from Java code, see the section: [Programming Languages | Java](#)¹¹⁵⁹.

```
public class SPYSchemaDefKind
{
    public final static long spyKindElement = 0;
    public final static long spyKindComplexType = 1;
    public final static long spyKindSimpleType = 2;
    public final static long spyKindGroup = 3;
    public final static long spyKindModel = 4;
    public final static long spyKindAny = 5;
    public final static long spyKindAttr = 6;
}
```

```

public final static long spyKindAttrGroup      = 7;
public final static long spyKindAttrAny       = 8;
public final static long spyKindIdentityUnique= 9;
public final static long spyKindIdentityKey   = 10;
public final static long spyKindIdentityKeyRef= 11;
public final static long                      = 12;
spyKindIdentitySelector
public final static long spyKindIdentityField = 13;
public final static long spyKindNotation     = 14;
public final static long spyKindInclude      = 15;
public final static long spyKindImport       = 16;
public final static long spyKindRedefine     = 17;
public final static long spyKindFacet        = 18;
public final static long spyKindSchema       = 19;
public final static long spyKindCount        = 20;
}

```

26.3.5.27.26 SPYSchemaDocumentationFormat (obsolete)

The objects described in this section (Application API for Java) are obsolete from v2012 onwards.

For information about how to access the Application API from Java code, see the section: [Programming Languages | Java](#)¹¹⁵⁹.

```

public class SPYSchemaDocumentationFormat
{
    public final static long          = 0;
    spySchemaDoc_HTML
    public final static long          = 1;
    spySchemaDoc_MSWord
    public final static long          = 2;
    spySchemaDoc_RTF
    public final static long          = 3;
    spySchemaDoc_PDF
}

```

26.3.5.27.27 SPYSchemaExtensionType (obsolete)

The objects described in this section (Application API for Java) are obsolete from v2012 onwards.

For information about how to access the Application API from Java code, see the section: [Programming Languages | Java¹¹⁵⁹](#).

```
public class SPYSchemaExtensionType
{
    public final static long spySchemaExtension_None      = 0;
    public final static long spySchemaExtension_SQL_XML   = 1;
    public final static long
    spySchemaExtension_MS_SQL_Server
    public final static long spySchemaExtension_Oracle   = 3;
}
```

26.3.5.27.28 SPYSchemaFormat (obsolete)

The objects described in this section (Application API for Java) are obsolete from v2012 onwards.

For information about how to access the Application API from Java code, see the section: [Programming Languages | Java¹¹⁵⁹](#).

```
public class SPYSchemaFormat
{
    public final static long
    spySchemaFormat_Hierarchical      = 0;
    public final static long spySchemaFormat_Flat      = 1;
}
```

26.3.5.27.29 SPYTextDelimiters (obsolete)

The objects described in this section (Application API for Java) are obsolete from v2012 onwards.

For information about how to access the Application API from Java code, see the section: [Programming Languages | Java¹¹⁵⁹](#).

```
public class SPYTextDelimiters
{
    public final static long spyTabulator = 0;
    public final static long spySemicolon = 1;
}
```

```
    public final static long spyComma      = 2;
    public final static long spySpace     = 3;
}
```

26.3.5.27.30 SPYTextEnclosing (obsolete)

The objects described in this section (Application API for Java) are obsolete from v2012 onwards.

For information about how to access the Application API from Java code, see the section: [Programming Languages | Java](#)¹¹⁵⁹.

```
public class SPYTextEnclosing
{
    public final static long      = 0;
    spyNoEnclosing
    public final static long      = 1;
    spySingleQuote
    public final static long      = 2;
    spyDoubleQuote
}
```

26.3.5.27.31 SPYTypeDetection (obsolete)

The objects described in this section (Application API for Java) are obsolete from v2012 onwards.

For information about how to access the Application API from Java code, see the section: [Programming Languages | Java](#)¹¹⁵⁹.

```
public class SPYTypeDetection
{
    public final static long      = 0;
    spyBestPossible
    public final static long      = 1;
    spyNumbersOnly
    public final static long      = 2;
    spyNoDetection
}
```

26.3.5.27.32 SPYURLTypes (obsolete)

The objects described in this section (Application API for Java) are obsolete from v2012 onwards.

For information about how to access the Application API from Java code, see the section: [Programming Languages | Java](#)¹¹⁵⁹.

```
public class SPYURLTypes
{
    public final static long      spyURLTypeAuto      = (-1);
    public final static long      spyURLTypeXML       = 0;
    public final static long      spyURLTypeDTD       = 1;
}
```

26.3.5.27.33 SpyViewModes (obsolete)

The objects described in this section (Application API for Java) are obsolete from v2012 onwards.

For information about how to access the Application API from Java code, see the section: [Programming Languages | Java](#)¹¹⁵⁹.

```
public class SPYViewModes
{
    public final static long spyViewGrid      = 0;
    public final static long spyViewText     = 1;
    public final static long spyViewBrowser  = 2;
    public final static long spyViewSchema   = 3;
    public final static long spyViewContent  = 4;
    public final static long spyViewAuthentic= 4;
    public final static long spyViewWSDL    = 5;
    public final static long spyViewZIP     = 6;
    public final static long spyViewEditionInfo
}
```

26.3.5.27.34 SPYWhitespaceComparison (obsolete)

The objects described in this section (Application API for Java) are obsolete from v2012 onwards.

For information about how to access the Application API from Java code, see the section: [Programming Languages | Java](#)¹¹⁵⁹.

```
public class SPYWhitespaceComparison
{
    public final static long spyCompareAsIs = 0;
    public final static long spyCompareNormalized = 1;
    public final static long spyStripAll = 2;
}
```

26.3.5.27.35 SPYXMLDataKind (obsolete)

The objects described in this section (Application API for Java) are obsolete from v2012 onwards.

For information about how to access the Application API from Java code, see the section: [Programming Languages | Java](#)¹¹⁵⁹.

```
public class SPYXMLDataKind
{
    public final static long spyXMLDataXMLDocStruct = 0;
    public final static long spyXMLDataXMLEntityDocStruct = 1;
    public final static long spyXMLDataDTDDocStruct = 2;
    public final static long spyXMLDataXML = 3;
    public final static long spyXMLDataElement = 4;
    public final static long spyXMLDataAttr = 5;
    public final static long spyXMLDataText = 6;
    public final static long spyXMLDataCData = 7;
    public final static long spyXMLDataComment = 8;
    public final static long spyXMLDataPI = 9;
}
```

```
    public final static long spyXMLDataDefDoctype = 10;
    public final static long spyXMLDataDefExternalID = 11;
    public final static long spyXMLDataDefElement = 12;
    public final static long spyXMLDataDefAttlist = 13;
    public final static long spyXMLDataDefEntity = 14;
    public final static long spyXMLDataDefNotation = 15;
    public final static long spyXMLDataKindsCount = 16;
}
```

26.4 ActiveX Integration

The XMLSpy user interface and the functionality described in this section can be integrated into custom applications that can consume ActiveX controls. ActiveX technology enables a wide variety of languages to be used for integration, such as C++, C#, and VB.NET. All components are full OLE Controls. Integration into Java is provided through wrapper classes.

To integrate the ActiveX controls into your custom code, the XMLSpy Integration Package must be installed (see <https://www.altova.com/components/download>). Ensure that you install XMLSpy first, and then the XMLSpy Integration Package. Other prerequisites apply, depending on language and platform (see [Prerequisites](#)¹⁴⁸⁰).

You can flexibly choose between two different levels of integration: application level and document level.

Integration at application level means embedding the complete interface of XMLSpy (including its menus, toolbars, panes, etc) as an ActiveX control into your custom application. For example, in the most simple scenario, your custom application could consist of only one form that embeds the XMLSpy graphical user interface. This approach is easier to implement than integration at document level but may not be suitable if you need flexibility to configure the XMLSpy graphical user interface according to your custom requirements.

Integration at document level means embedding XMLSpy into your own application piece-by-piece. This includes implementing not only the main XMLSpy control but also the main document editor window, and, optionally, any additional windows. This approach provides greater flexibility to configure the GUI, but requires advanced interaction with ActiveX controls in your language of choice.

The sections [Integration at the Application Level](#)¹⁴⁸³ and [Integration at Document Level](#)¹⁴⁸⁵ describe the key steps at these respective levels. The [ActiveX Integration Examples](#)¹⁴⁸⁸ section provides examples in C# and Java. Looking through these examples will help you to make the right decisions quickly. The [Object Reference](#)¹⁵²⁰ section describes all COM objects that can be used for integration, together with their properties and methods.

For information about using XMLSpy as a Visual Studio plug-in, see [XMLSpy in Visual Studio](#)⁷⁶⁷.

26.4.1 Prerequisites

To integrate the XMLSpy ActiveX control into a custom application, the following must be installed on your computer:

- XMLSpy
- The XMLSpy Integration Package, available for download at <https://www.altova.com/components/download>

To integrate the 64-bit ActiveX control, install the 64-bit versions of XMLSpy and XMLSpy Integration Package. For applications developed under Microsoft .NET platform with Visual Studio, both the 32-bit and 64-bit versions of XMLSpy and XMLSpy Integration Package must be installed, as explained below.

Microsoft .NET (C#, VB.NET) with Visual Studio

To integrate the XMLSpy ActiveX control into a 32-bit application developed under Microsoft .NET, the following must be installed on your computer:

- Microsoft .NET Framework 4.0 or later
- Visual Studio 2012/2013/2015/2017/2019/2022
- XMLSpy 32-bit and XMLSpy Integration Package 32-bit
- The ActiveX controls must be added to the Visual Studio toolbox (see [Adding the ActiveX Controls to the Toolbox](#)¹⁴⁸³).

If you want to integrate the 64-bit ActiveX control, the following prerequisites apply in addition to the ones above:

- XMLSpy 32-bit and XMLSpy Integration Package 32-bit must still be installed (this is required to provide the 32-bit ActiveX control to the Visual Studio designer, since Visual Studio runs on 32-bit)
- XMLSpy 64-bit and XMLSpy Integration Package 64-bit must be installed (provides the actual 64-bit ActiveX control to your custom application at runtime)
- In Visual Studio, create a 64-bit build configuration and build your application using this configuration. For an example, see [Running the Sample C# Solution](#)¹⁴⁸⁸.

Java

To integrate the XMLSpy ActiveX control into Java application using the Eclipse development environment, the following must be installed on your computer:

- Java Runtime Environment (JRE) or Java Development Kit (JDK) 7 or later
- Eclipse
- XMLSpy and XMLSpy Integration Package

Note: To run the 64-bit version of the XMLSpy ActiveX control, use a 64-bit version of Eclipse, as well as the 64-bit version of XMLSpy and the XMLSpy Integration Package.

XMLSpy integration and deployment on client computers

If you create a .NET application and intend to distribute it to other clients, you will need to install the following on the client computer(s):

- XMLSpy
- The XMLSpy Integration Package
- The custom integration code or application.

26.4.2 Adding the ActiveX Controls to the Toolbox

To use the XMLSpy ActiveX controls in an application developed with Visual Studio, the controls must first be added to the Visual Studio Toolbox, as follows:

1. On the **Tools** menu of Visual Studio, click **Choose Toolbox Items**.

2. On the **COM Components** tab, select the check boxes next to the XMLSpyControl, XMLSpyControl Document, and XMLSpyControl Placeholder.

In case the controls above are not available, follow the steps below:

1. On the **COM Components** tab, click **Browse**, and select the **XMLSpyControl.ocx** file from the XMLSpy installation folder. Remember that the XMLSpy Integration Package must be installed; otherwise, this file is not available, see [Prerequisites](#)¹⁴⁸⁰.
2. If prompted to restart Visual Studio with elevated permissions, click **Restart under different credentials**.

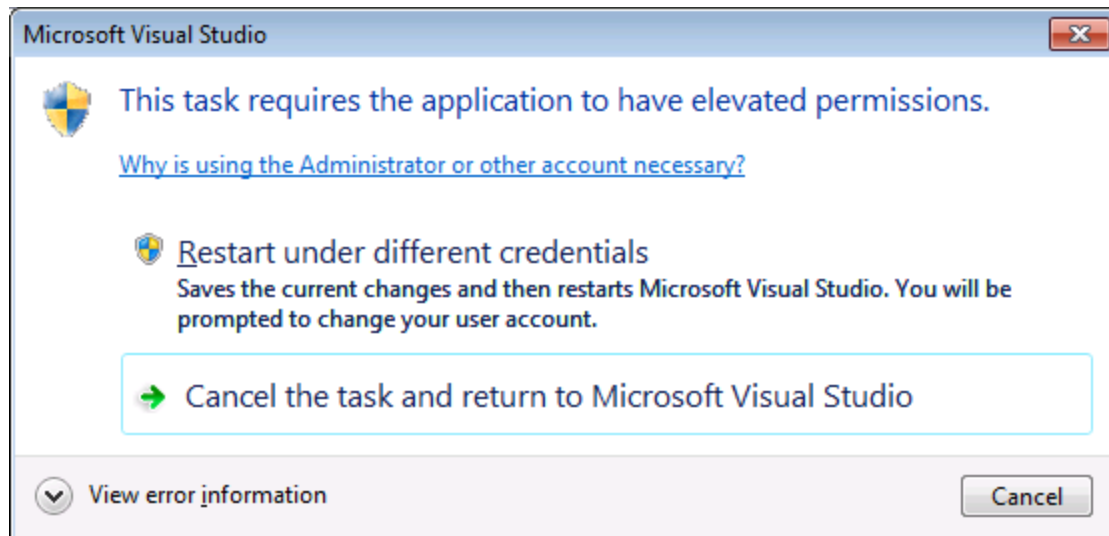

If the steps above were successful, the XMLSpy ActiveX controls become available in the Visual Studio Toolbox.

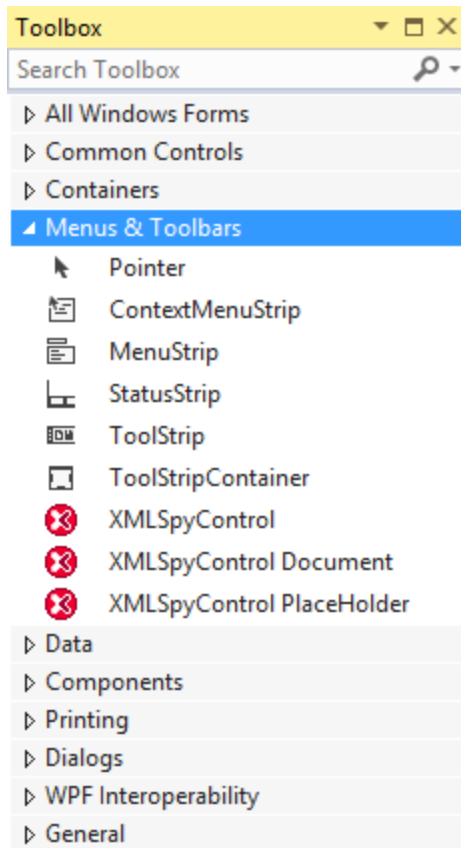

Note: For an application-level integration, only the **XMLSpyControl** ActiveX control is used (see [Integration at Application Level](#)¹⁴⁸³). The **XMLSpyControl Document** and **XMLSpyControl Placeholder** controls are used for document-level integration (see [Integration at Document Level](#)¹⁴⁸⁵).

26.4.3 Integration at Application Level

Integration at application level allows you to embed the complete interface of XMLSpy into a window of your application. With this type of integration, you get the whole user interface of XMLSpy, including all menus, toolbars, the status bar, document windows, and helper windows. Customization of the application's user interface is restricted to what XMLSpy provides. This includes rearrangement and resizing of helper windows and customization of menus and toolbars.

The only ActiveX control you need to integrate is [XMLSpyControl](#)¹⁵²⁴. Do not instantiate or access [XMLSpyControlDocument](#)¹⁵³² or [XMLSpyControlPlaceholder](#)¹⁵³⁹ ActiveX controls when integrating at application-level.

If you have any initialization to do or if you want to automate some behaviour of XMLSpy, use the properties, methods, and events described for [XMLSpyControl](#)¹⁵²⁴. Consider using [XMLSpyControl.Application](#)¹⁵²⁵ for more complex access to XMLSpy functionality.

In C# or VB.NET with Visual Studio, the steps to create a basic, one-form application which integrates the XMLSpy ActiveX controls at application level are as follows:

1. Check that all prerequisites are met (see [Prerequisites](#)¹⁴⁸⁰).
2. Create a new Visual Studio Windows Forms project with a new empty form.
3. If you have not done that already, add the ActiveX controls to the toolbox (see [Adding the ActiveX Controls to the Toolbox](#)¹⁴⁸¹).
4. Drag the **XMLSpyControl** from the toolbox onto your new form.
5. Select the **XMLSpyControl** on the form, and, in the Properties window, set the **IntegrationLevel** property to **ICActiveXIntegrationOnApplicationLevel**.

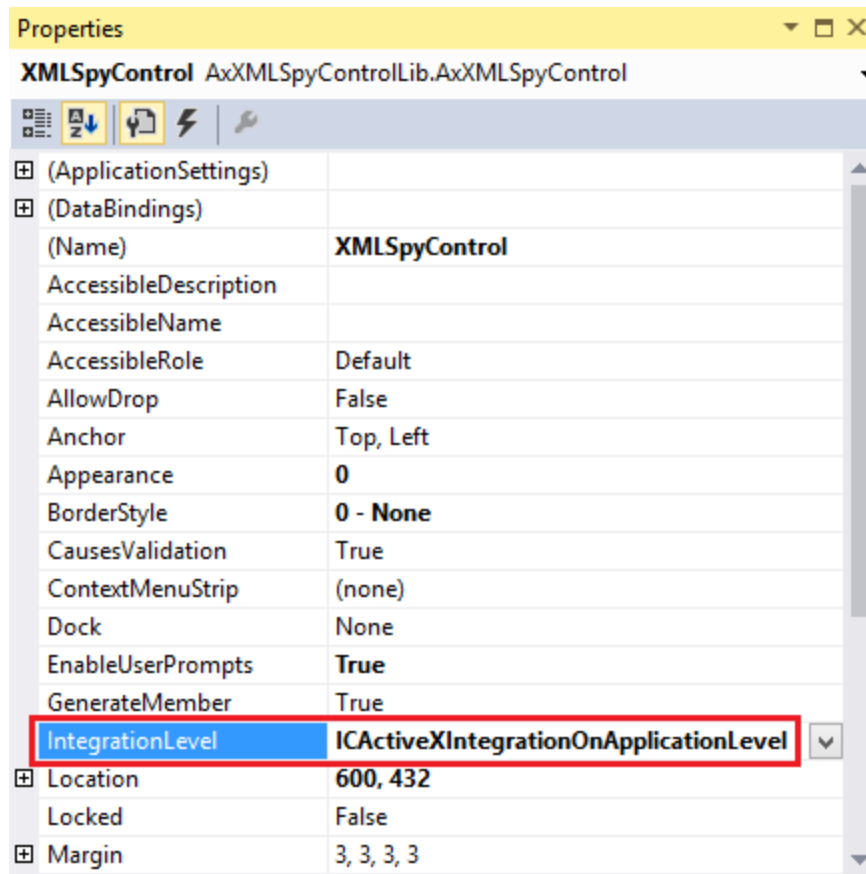

6. Create a build platform configuration that matches the platform under which you want to build (x86, x64). Here is how you can create the build configuration:
 - a. Right-click the solution in Visual Studio, and select **Configuration Manager**.
 - b. Under **Active solution platform**, select **New...** and then select the x86 or x64 configuration (in this example, **x86**).

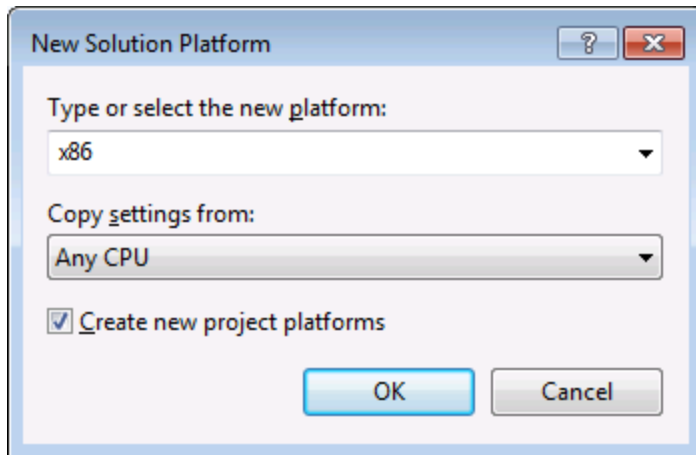

You are now ready to build and run the solution in Visual Studio. Remember to build using the configuration that matches your target platform (x86, x64).

26.4.4 Integration at Document Level

Compared to integration at application level, integration at document level is a more complex, yet more flexible way to embed XMLSpy functionality into your application by means of ActiveX controls. With this approach, your code can access selectively the following parts of the XMLSpy user interface:

- Document editing window
- Project window
- Entry helper windows
- Validator output window
- XPath profiler window
- XPath dialog window
- XSLT/XQuery debugger windows

As mentioned in [Integration at Application Level](#)¹⁴⁸³, for an ActiveX integration at application level, only one control is required, namely the **XMLSpyControl**. However, for an ActiveX integration at document level, XMLSpy functionality is provided by the following ActiveX controls:

- [XMLSpyControl](#)¹⁵²⁴
- [XMLSpyControl Document](#)¹⁵³²
- [XMLSpyControl Placeholder](#)¹⁵³⁹

These controls are supplied by the XMLSpyControl.ocx file available in the application installation folder of XMLSpy. When you develop the ActiveX integration with Visual Studio, you will need to add these controls to the Visual Studio toolbox (see [Adding the ActiveX Controls to the Toolbox](#)¹⁴⁸¹).

The basic steps to integrate the ActiveX controls at document level into your application are as follows:

1. First, instantiate XMLSpyControl in your application. Instantiating this control is mandatory; it enables support for the XMLSpyControl Document and XMLSpyControl Placeholder controls mentioned above. It is important to set the [IntegrationLevel](#)¹⁵²⁶ property to ICActiveXIntegrationOnDocumentLevel (or "1"). To hide the control from the user, set its Visible property to False. Note that, when integrating at

document level, do not use the Open method of the XMLSpyControl; this might lead to unexpected results. Use the corresponding open methods of XMLSpyControl Document and XMLSpyControl Placeholder instead.

2. Create at least one instance of XMLSpyControl Document in your application. This control supplies the document editing window of XMLSpy to your application and can be instantiated multiple times if necessary. Use the method Open to load any existing file. To access document-related functionality, use the Path and Save or methods and properties accessible via the property Document. Note that the control does not support a read-only mode. The value of the property ReadOnly is ignored.
3. Optionally, add to your application the XMLSpyControl Placeholder control for each additional window (other than the document window) that must be available to your application. Instances of XMLSpyControl Placeholder allow you to selectively embed additional windows of XMLSpy into your application. The window kind (for example, Project window) is defined by the property PlaceholderWindowID. Therefore, to set the window kind, set the property PlaceholderWindowID. For valid window identifiers, see [XMLSpyControlPlaceholderWindow](#)¹⁵⁴². Use only one XMLSpyControl Placeholder for each window identifier.

For placeholder controls that select the XMLSpy project window, additional methods are available. Use OpenProject to load a XMLSpy project. Use the property Project and the methods and properties from the XMLSpy automation interface to perform any other project related operations.

For example, in C# or VB.NET with Visual Studio, the steps to create a basic, one-form application which integrates the XMLSpy ActiveX controls at document level could be similar to those listed below. Note that your application may be more complex if necessary; however, the instructions below are important to understand the minimum requirements for an ActiveX integration at document level.

1. Create a new Visual Studio Windows Forms project with a new empty form.
2. If you have not done that already, add the ActiveX controls to the toolbox (see [Adding the ActiveX Controls to the Toolbox](#)¹⁴⁸¹).
3. Drag the [XMLSpyControl](#)¹⁵²⁴ from the toolbox onto your new form.
4. Set the IntegrationLevel property of the XMLSpyControl to ICActiveXIntegrationOnDocumentLevel, and the Visible property to False. You can do this either from code or from the Properties window.
5. Drag the [XMLSpyControl Document](#)¹⁵³² from the toolbox onto the form. This control provides the main document window of XMLSpy to your application, so you may need to resize it to a reasonable size for a document.
6. Optionally, add one or more [XMLSpyControl Placeholder](#)¹⁵³⁹ controls to the form (one for each additional window type that your application needs, for example, the Project window). You will typically want to place such additional placeholder controls either below or to the right or left of the main document control, for example:

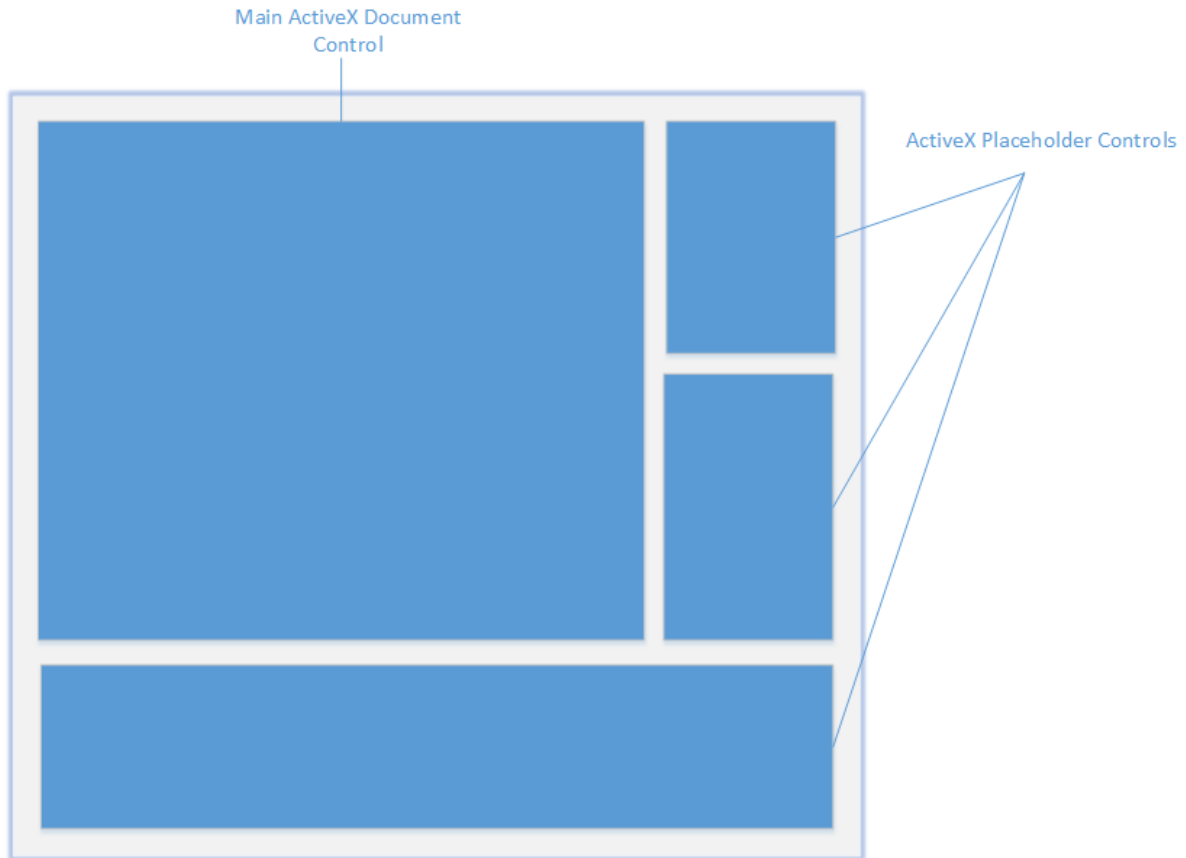

7. Set the PlaceholderWindowID property of each XMLSpyControl Placeholder control to a valid window identifier. For the list of valid values, see [XMLSpyControlPlaceholderWindow](#)¹⁵⁴².
8. Add commands to your application (at minimum, you will need to open, save and close documents), as shown below.

Querying XMLSpy Commands

When you integrate at document level, no XMLSpy menu or toolbar is available to your application. Instead, you can retrieve the required commands, view their status, and execute them programmatically, as follows:

- To retrieve all available commands, use the [CommandsList](#)¹⁵²⁵ property of the XMLSpyControl.
- To retrieve commands organized according to their menu structure, use the [MainMenu](#)¹⁵²⁶ property.
- To retrieve commands organized by the toolbar in which they appear, use the [Toolbars](#)¹⁵²⁷ property.
- To send commands to XMLSpy, use the [Exec](#)¹⁵²⁸ method.
- To query if a command is currently enabled or disabled, use the [QueryStatus](#)¹⁵²⁹ method.

This enables you to flexibly integrate XMLSpy commands into your application's menus and toolbars.

Your installation of XMLSpy also provides you with command label images used within XMLSpy. See the folder <ApplicationFolder>\Examples\ActiveX\Images of your XMLSpy installation for icons in GIF format. The file names correspond to the command names as they are listed in the [Command Reference](#)¹⁵⁰¹ section.

General considerations

To automate the behaviour of XMLSpy, use the properties, methods, and events described for the [XMLSpyControl](#)¹⁵²⁴, [XMLSpyControl Document](#)¹⁵³², and [XMLSpyControl Placeholder](#)¹⁵³⁹.

For more complex access to XMLSpy functionality, consider using the following properties:

- [XMLSpyControl.Application](#)¹⁵²⁵
- [XMLSpyControlDocument.Document](#)¹⁵³³
- [XMLSpyControlPlaceholder.Project](#)¹⁵⁴⁰

These properties give you access to the XMLSpy automation interface (XMLSpyAPI)

Note: To open a document, always use [XMLSpyControlDocument.Open](#)¹⁵³⁵ or [XMLSpyControlDocument.New](#)¹⁵³⁵ on the appropriate document control. To open a project, always use [XMLSpyControlPlaceholder.OpenProject](#)¹⁵⁴⁰ on a placeholder control embedding a XMLSpy project window.

For examples that show how to instantiate and access the necessary controls in different programming environments, see [ActiveX Integration Examples](#)¹⁴⁸⁸.

26.4.5 ActiveX Integration Examples

This section contains examples of XMLSpy document-level integration using different container environments and programming languages. Source code for all examples is available in the folder `<ApplicationFolder>\Examples\ActiveX` of your XMLSpy installation.

26.4.5.1 C#

A basic ActiveX integration example solution for C# and Visual Studio is available in the folder `<ApplicationFolder>\Examples\ActiveX\C#`. Before you compile the source code and run the sample, make sure that all prerequisites are met (see [Running the Sample C# Solution](#)¹⁴⁸⁸).

26.4.5.1.1 Running the Sample C# Solution

The sample Visual Studio solution available in the folder `<ApplicationFolder>\Examples\ActiveX\C#` illustrates how to consume the XMLSpy ActiveX controls. Before attempting to build and run this solution, note the following steps:

Step 1: Check the prerequisites

Visual Studio 2010 or later is required to open the sample solution. For the complete list of prerequisites, see [Prerequisites](#)¹⁴⁸⁰.

Step 2: Copy the sample to a directory where you have write permissions

To avoid running Visual Studio as an Administrator, copy the source code to a directory where you have write permissions, instead of running it from the default location.

Step 3: Check and set all required control properties

The sample application contains one instance of [XMLSpyControlDocument](#)¹⁵³² and one instance of [XMLSpyControlPlaceholder](#)¹⁵³⁹ controls. Double-check that the following properties of these controls are set as shown in the table below:

| Control name | Property | Property value |
|---------------|---------------------|-------------------------------------|
| XMLSpyControl | IntegrationLevel | ICActiveXIntegrationOnDocumentLevel |
| XPathDialog | PlaceholderWindowID | 16 |

Here is how you can view or set the properties of an ActiveX control:

1. Open the **MDIMain.cs** form in the designer window.

Note: On 64-bit Windows, it may be necessary to change the build configuration of the Visual Studio solution to "x86" **before** opening the designer window. If you need to build the sample as a 64-bit application, see [Prerequisites](#)¹⁴⁸⁰.

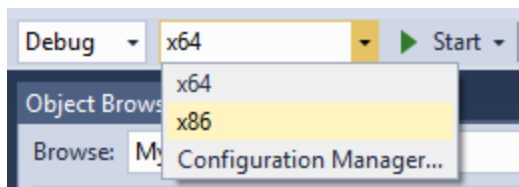

2. Open the **Document Outline** window of Visual Studio (On the **View** menu, click **Other Windows | Document Outline**).

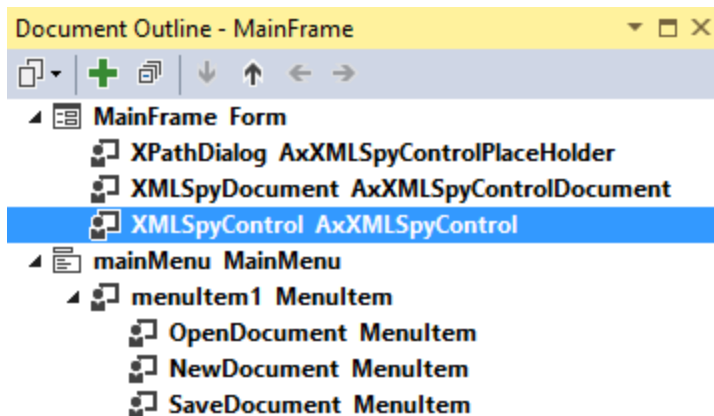

3. Click an ActiveX control in the **Document Outline** window, and edit its required property in the **Properties** window, for example:

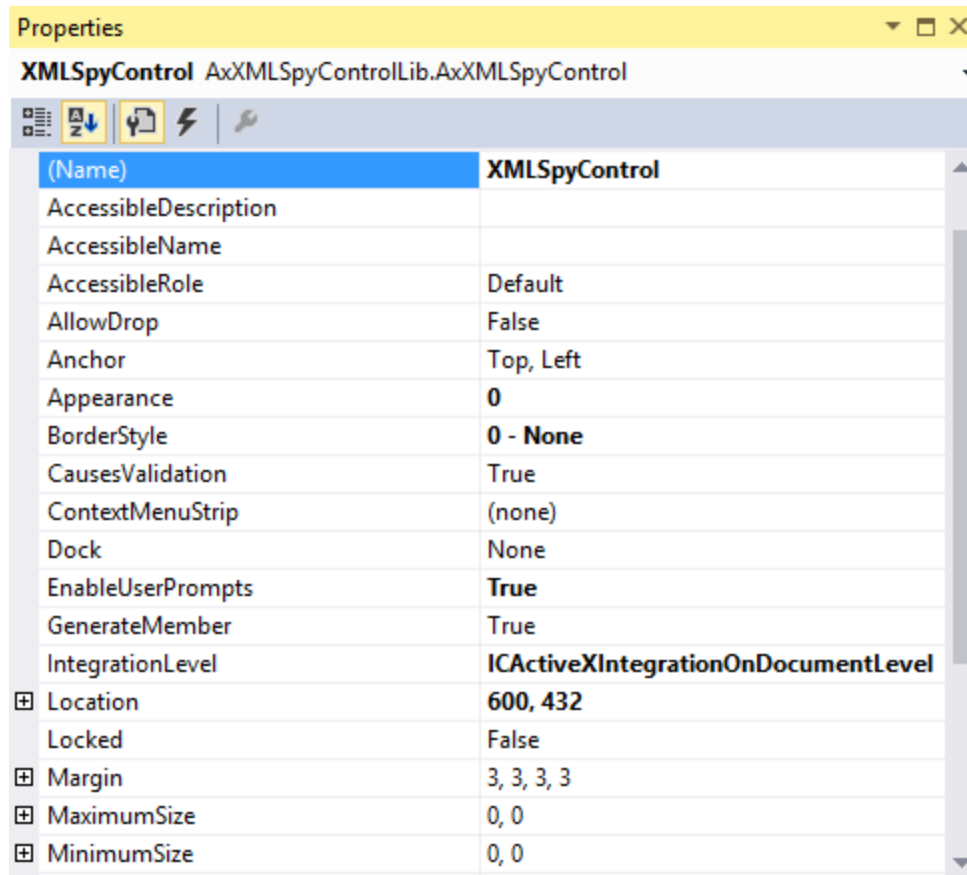

Step 4: Set the build platform

- Create a build platform configuration that matches the platform under which you want to build (x86, x64). Here is how you can create the build configuration:
 - a. Right-click the solution in Visual Studio, and select **Configuration Manager**.
 - b. Under **Active solution platform**, select **New...** and then select the x86 or x64 configuration (in this example, **x86**).

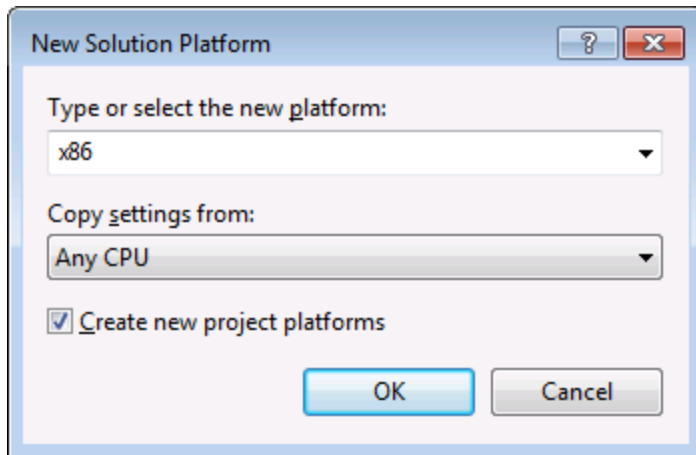

You are now ready to build and run the solution in Visual Studio. Remember to build using the configuration that matches your target platform (x86, x64); otherwise, runtime errors might occur.

On running the sample, the main MDI Frame window is created and contains an editing window with an empty XML document and a XPath Dialog window of XMLSpy at the bottom. Use **File | Open** to open any XML file from the XMLSpy examples folder. The file is loaded and displayed. After you load the document, you can start using the XPath dialog. Note that you may need to slightly drag the lower-right corner of the form to cause the dialog to redraw itself and display its contents.

26.4.5.2 Java

XMLSpy ActiveX components can be accessed from Java code. Java integration is provided by the libraries listed below. These libraries are available in the folder `<ApplicationFolder>\Examples\JavaAPI` of your XMLSpy installation, after you have installed both XMLSpy and the XMLSpy Integration Package (see also [Prerequisites](#)¹⁴⁸⁰).

- `AltovaAutomation.dll`: a JNI wrapper for Altova automation servers (in case of the 32-bit installation of XMLSpy)
- `AltovaAutomation_x64.dll`: a JNI wrapper for Altova automation servers (in case of the 64-bit installation of XMLSpy)
- `AltovaAutomation.jar`: Java classes to access Altova automation servers
- `XMLSpyActiveX.jar`: Java classes that wrap the XMLSpy ActiveX interface
- `XMLSpyActiveX_JavaDoc.zip`: a Javadoc file containing help documentation for the Java interface

Note: In order to use the Java ActiveX integration, the `.dll` and `.jar` files must be included in the Java class search path.

Example Java project

An example Java project is supplied with your product installation. You can test the Java project and modify and use it as you like. For more details, see [Example Java Project](#)¹⁴⁹³.

Rules for mapping the ActiveX Control names to Java

For the documentation of ActiveX controls, see [Object Reference](#)¹⁵²⁰. Note that the object naming conventions are slightly different in Java compared to other languages. Namely, the rules for mapping between the ActiveX controls and the Java wrapper are as follows:

Classes and class names

For every component of the XMLSpy ActiveX interface a Java class exists with the name of the component.

Method names

Method names on the Java interface are the same as used on the COM interfaces but start with a small letter to conform to Java naming conventions. To access COM properties, Java methods that prefix the property name with get and set can be used. If a property does not support write-access, no setter method is available. Example: For the `IntegrationLevel` property of the `XMLSpyControl`, the Java methods `getIntegrationLevel` and `setIntegrationLevel` are available.

Enumerations

For every enumeration defined in the ActiveX interface, a Java enumeration is defined with the same name and values.

Events and event handlers

For every interface in the automation interface that supports events, a Java interface with the same name plus 'Event' is available. To simplify the overloading of single events, a Java class with default implementations for all events is provided. The name of this Java class is the name of the event interface plus 'DefaultHandler'. For example:

```
XMLSpyControl: Java class to access the application
XMLSpyControlEvents: Events interface for the XMLSpyControl
XMLSpyControlEventsDefaultHandler: Default handler for XMLSpyControlEvents
```

Exceptions to mapping rules

There are some exceptions to the rules listed above. These are listed below:

| Interface | Java name |
|--|-----------------|
| XMLSpyControlDocument, method New | newDocument |
| Document, method SetEncoding | setFileEncoding |
| AuthenticView, method Goto | gotoElement |
| AuthenticRange, method Goto | gotoElement |
| AuthenticRange, method Clone | cloneRange |

This section

This section shows how some basic XMLSpy ActiveX functionality can be accessed from Java code. It is organized into the following sub-sections:

- [Example Java Project](#)¹⁴⁹³
- [Creating the ActiveX Controls](#)¹⁴⁹⁵
- [Loading Data in the Controls](#)¹⁴⁹⁶

- [Basic Event Handling](#) ¹⁴⁹⁶
- [Menus](#) ¹⁴⁹⁷
- [UI Update Event Handling](#) ¹⁴⁹⁸
- [Creating an XML Tree](#) ¹⁴⁹⁹

26.4.5.2.1 Example Java Project

The XMLSpy installation package contains an example Java project, located in the ActiveX Examples folder of the application folder: `<ApplicationFolder>\Examples\ActiveX\Java\`.

The Java example shows how to integrate the XMLSpyControl in a common desktop application created with Java. You can test it directly from the command line using the batch file `BuildAndRun.bat`, or you can compile and run the example project from within Eclipse. See below for instructions on how to use these procedures.

File list

The Java examples folder contains all the files required to run the example project. These files are listed below:

| | |
|---|--|
| <code>.classpath</code> | Eclipse project helper file |
| <code>.project</code> | Eclipse project file |
| <code>AltovaAutomation.dll</code> | Java-COM bridge: DLL part (for the 32-bit installation) |
| <code>AltovaAutomation_x64.dll</code> | Java-COM bridge: DLL part (for the 64-bit installation) |
| <code>AltovaAutomation.jar</code> | Java-COM bridge: Java library part |
| <code>BuildAndRun.bat</code> | Batch file to compile and run example code from the command line prompt. Expects folder where Java Virtual Machine resides as parameter. |
| <code>XMLSpyActiveX.jar</code> | Java classes of the XMLSpy ActiveX control |
| <code>XMLSpyActiveX_JavaDoc.zip</code> | Javadoc file containing help documentation for the Java API |
| <code>XMLSpyContainer.java</code> | Java example source code |
| <code>XMLSpyContainerEventHandler.java</code> | Java example source code |
| <code>XMLTreeDialog.java</code> | Java example source code |

What the example does

The example places one XMLSpy document editor window, the XMLSpy project window, the XMLSpy XPath window and an XMLSpy entry helper in an AWT frame window. It reads out the File menu defined for XMLSpy and creates an AWT menu with the same structure. You can use this menu or the project window to open and work with files in the document editor.

You can modify the example in any way you like.

The following specific features are described in code listings:

- [Creating the ActiveX Controls](#)¹⁴⁹⁵: Starts XMLSpy, which is registered as an automation server, or activates XMLSpy if it is already running.
- [Loading Data in the Controls](#)¹⁴⁹⁶: Locates one of the example documents installed with XMLSpy and opens it.
- [Basic Event Handling](#)¹⁴⁹⁶: Changes the view of all open documents to Text View. The code also shows how to iterate through open documents.
- [Menus](#)¹⁴⁹⁷: Validates the active document and shows the result in a message box. The code shows how to use output parameters.
- [UI Update Event Handling](#)¹⁴⁹⁸: Shows how to handle XMLSpy events.
- [Creating an XML Tree](#)¹⁴⁹⁹: Shows how to create an XML tree and prepare it for modal activation.

Updating the path to the Examples folder

Before running the provided sample, you may need to edit the **XMLSpyContainer.java** file. Namely, check that the following path refers to the actual folder where the XMLSpy example files are stored on your operating system:

```
// Locate samples installed with the product.
final String strExamplesFolder = System.getenv( "USERPROFILE" ) + "\\Documents\\Altova\\
\\XMLSpy2024\\XMLSpyExamples\\";
```

Running the example from the command line

To run the example from the command line:

1. Check that all prerequisites are met (see [Prerequisites](#)¹⁴⁸⁰).
2. Open a command prompt window, change the current directory to the sample Java project folder, and type:

```
buildAndRun.bat "<Path-to-the-Java-bin-folder>"
```

3. Press **Enter**.

The Java source in `XMLSpyContainer.java` will be compiled and then executed.

Compiling and running the example in Eclipse

To import the sample Java project into Eclipse:

1. Check that all prerequisites are met (see [Prerequisites](#)¹⁴⁸⁰).
2. On the **File** menu, click **Import**.
3. Select **Existing Projects into Workspace**, and browse for the Eclipse project file located at `<ApplicationFolder>\Examples\ActiveX\Java\`. Since you may not have write-access in this folder, it is recommended to select the **Copy projects into workspace** check box on the Import dialog box.

To run the example application, right-click the project in Package Explorer and select the command **Run as | Java Application**.

Help for Java API classes is available through comments in code as well as the Javadoc view of Eclipse. To enable the Javadoc view in Eclipse, select the menu command **Window | Show View | JavaDoc**.

26.4.5.2.2 Creating the ActiveX Controls

The code listing below show how ActiveX controls can be created. The constructors will create the Java wrapper objects. Adding these Canvas-derived objects to a panel or to a frame will trigger the creation of the wrapped ActiveX object.

```
01 /**
02  * XMLSpy manager control - always needed
03  */
04  public static XMLSpyControl          xmlSpyControl = null;
05
06 /**
07  * XMLSpy document editing control
08  */
09  public static XMLSpyControlDocument  xmlSpyDocument = null;
10
11 /**
12  * Tool windows - XMLSpy place-holder controls
13  */
14  private static XMLSpyControlPlaceholder  xmlSpyProjectToolWindow = null;
15  private static XMLSpyControlPlaceholder  xmlSpyXPathToolWindow = null;
16  private static XMLSpyControlPlaceholder  xmlSpyEHAttributeToolWindow = null;
17
18  // Create the XMLSpy ActiveX control; the parameter determines that we want
19  // to place document controls and place-holder controls individually.
20  // It gives us full control over the menu, as well.
21  xmlSpyControl = new XMLSpyControl(
22      IActiveXIntegrationLevel.IActiveXIntegrationOnDocumentLevel.getValue() );
23  xmlSpyDocument = new XMLSpyControlDocument();
24  xmlSpyDocument.setPreferredSize( new Dimension ( 640, 480 ) );
25
26  // Create a project window and open the sample project in it
27  xmlSpyProjectToolWindow = new XMLSpyControlPlaceholder(
28      XMLSpyControlPlaceholderWindow.XMLSpyControlProjectWindowToolWnd.getValue() );
29  xmlSpyProjectToolWindow.setPreferredSize( new Dimension( 200, 200 ) );
30  xmlSpyXPathToolWindow = new XMLSpyControlPlaceholder(
31      XMLSpyControlPlaceholderWindow.XMLSpyControlXPathDialogToolWnd.getValue() );
32  xmlSpyEHAttributeToolWindow = new XMLSpyControlPlaceholder(
33      XMLSpyControlPlaceholderWindow.XMLSpyControlEntryHelperTopToolWnd.getValue() );
34
35  frame.add( xmlSpyControl, BorderLayout.NORTH );
36  frame.add( xmlSpyDocument, BorderLayout.CENTER );
37  southPanel.add( xmlSpyProjectToolWindow );
38  southPanel.add( xmlSpyXPathToolWindow );
39  southPanel.add( xmlSpyEHAttributeToolWindow );
```

26.4.5.2.3 Loading Data in the Controls

The code listing below show how data can be loaded in the ActiveX controls.

```
1 // Locate samples installed with the product.
2 final String strExamplesFolder = System.getenv( "USERPROFILE" ) +
  "\\Documents\\Altova\\XMLSpy2024\\Examples\\";
3 xmlSpyProjectToolWindow.openProject( strExamplesFolder + "Examples.spp" );
```

26.4.5.2.4 Basic Event Handling

The code listing below shows how basic events can be handled. When calling the XMLSpyControl's `open` method, or when trying to open a file via the menu or Project tree, the `onOpenedOrFocused` event is sent to the attached event handler. The basic handling for this event is opening the file by calling the XMLSpyDocumentControl's `open` method.

```
01 // Open the PXF file when button is pressed
02 btnOpenPxf.addActionListener( new ActionListener() {
03     public void actionPerformed(ActionEvent e) {
04         try {
05             xmlSpyControl.open( strExamplesFolder + "OrgChart.pxf" );
06         } catch (AutomationException e1) {
07             e1.printStackTrace();
08         }
09     }
10 } );
11 public void onOpenedOrFocused( String i_strFileName, boolean
i_bOpenWithThisControl, boolean i_bFileAlreadyOpened ) throws AutomationException
12 {
13     // Handle the New/Open events coming from the Project tree or from the menus
14     if ( !i_bFileAlreadyOpened )
15     {
16         // This is basically an SDI interface, so open the file in the already existing
document control
17         try {
18             XMLSpyContainer.xmlSpyDocument.open( i_strFileName );
19             XMLSpyContainer.xmlSpyDocument.requestFocusInWindow();
20         } catch (Exception e) {
21             e.printStackTrace();
22         }
23     }
24 }
```

26.4.5.2.5 Menus

The code listing below shows how menu items can be created. Each `XMLSpyCommand` object gets a corresponding `MenuItem` object, with the `ActionCommand` set to the ID of the command. The actions generated by all menu items are handled by the same function, which can perform specific handlings (like reinterpreting the closing mechanism) or can delegate the execution to the `XMLSpyControl` object by calling its `exec` method. The `menuMap` object that is filled during menu creation is used later (see section [UI Update Event Handling](#)¹⁴⁹⁸).

```

01 // Load the file menu when the button is pressed
02     btnMenu.addActionListener( new ActionListener() {
03         public void actionPerformed(ActionEvent e) {
04             try {
05                 // Create the menubar that will be attached to the frame
06                 MenuBar mb = new MenuBar();
07                 // Load the main menu's first item - the File menu
08                 XMLSpyCommand xmlSpyMenu =
xmlSpyControl.getMainMenu().getSubCommands().getItem( 0 );
09                 // Create Java menu items from the Commands objects
10                 Menu fileMenu = new Menu();
11                 handlerObject.fillMenu( fileMenu, xmlSpyMenu.getSubCommands() );
12                 fileMenu.setLabel( xmlSpyMenu.getLabel().replace( "&", "" ) );
13                 mb.add( fileMenu );
14                 frame.setMenuBar( mb );
15                 frame.validate();
16             } catch (AutomationException e1) {
17                 e1.printStackTrace();
18             }
19             // Disable the button when the action has been performed
20             ((AbstractButton) e.getSource()).setEnabled( false );
21         }
22     } );
23 /** * Populates a menu with the commands and submenus contained in an XMLSpyCommands
object */
24     public void fillMenu(Menu newMenu, XMLSpyCommands xmlSpyMenu) throws
AutomationException
25     {
26         // For each command/submenu in the xmlSpyMenu
27         for ( int i = 0 ; i < xmlSpyMenu.getCount() ; ++i )
28         {
29             XMLSpyCommand xmlSpyCommand = xmlSpyMenu.getItem( i );
30             if ( xmlSpyCommand.getIsSeparator() )
31                 newMenu.addSeparator();
32             else
33             {
34                 XMLSpyCommands subCommands = xmlSpyCommand.getSubCommands();
35                 // Is it a command (leaf), or a submenu?
36                 if ( subCommands.isNull() || subCommands.getCount() == 0 )
37                 {
38                     // Command -> add it to the menu, set its ActionCommand to its ID and store it
in the menuMap
39                     MenuItem mi = new MenuItem( xmlSpyCommand.getLabel().replace( "&", "" ) );
40                     mi.setActionCommand( "" + xmlSpyCommand.getID() );

```

```

41     mi.addActionListener( this );
42     newMenu.add( mi );
43     menuMap.put( xmlSpyCommand.getID(), mi );
44     }
45     else
46     {
47         // Submenu -> create submenu and repeat recursively
48         Menu newSubMenu = new Menu();
49         fillMenu( newSubMenu, subCommands );
50         newSubMenu.setLabel( xmlSpyCommand.getLabel().replace( "&", "" ) );
51         newMenu.add( newSubMenu );
52     }
53     }
54 }
55 }
56
57 /**
58  * Action handler for the menu items
59  * Called when the user selects a menu item; the item's action command corresponds to
the command table for XMLSpy
60  */
61 public void actionPerformed((ActionEvent e)
62 {
63     try
64     {
65         int iCmd = Integer.parseInt( e.getActionCommand() );
66         // Handle explicitly the Close commands
67         switch ( iCmd )
68         {
69             case 57602:        // Close
70             case 34050:        // Close All
71                 XMLSpyContainer.initXmlSpyDocument();
72                 break;
73             default:
74                 XMLSpyControl.xmlSpyControl.exec( iCmd );
75                 break;
76         }
77     }
78     catch ( Exception ex )
79     {
80         ex.printStackTrace();
81     }
82 }
83 }

```

26.4.5.2.6 UI Update Event Handling

The code listing below shows how a UI-Update event handler can be created.

```

01 /**
02  * Call-back from the XMLSpyControl.
03  * Called to enable/disable commands

```

```

04  */
05  @Override
06  public void onUpdateCmdUI() throws AutomationException
07  {
08      // A command should be enabled if the result of queryStatus contains the Supported
(1) and Enabled (2) flags
09      for ( java.util.Map.Entry<Integer, MenuItem> pair : menuMap.entrySet() )
10
pair.getValue().setEnabled( XMLSpyContainer.xmlSpyControl.queryStatus( pair.getKey() ) >
2 );
11  }
12  /**
13   * Call-back from the XMLSpyControl.
14   * Usually called while enabling/disabling commands due to UI updates
15   */
16  @Override
17  public boolean onIsActiveEditor( String i_strFilePath ) throws AutomationException
18  {
19      try {
20          return
XMLSpyContainer.xmlSpyDocument.getDocument().getFullName().equalsIgnoreCase( i_strFilePath
);
21      } catch ( Exception e ) {
22          return false;
23      }
24  }

```

26.4.5.2.7 Creating an XML Tree

The listing below loads an XML data object as nodes in a tree.

```

01 // access required XMLSpy Java-COM classes
02 import com.altova.automation.XMLSpy.XMLData;
03
04 // access AWT and Swing components
05 import java.awt.*;
06 import javax.swing.*;
07 import javax.swing.tree.*;
08
09 /**
10  * A simple example of a tree control loading the structure from an XMLData object.
11  * The class receives an XMLData object, loads its nodes in a JTree, and prepares
12  * for modal activation.
13  *
14  * Feel free to modify and extend this sample.
15  *
16  * @author Altova GmbH
17  */
18 class XMLTreeDialog extends JDialog
19 {
20     /**
21      * The tree control

```

```
22  */
23  private JTree myTree;
24
25  /**
26   * Root node of the tree control
27   */
28  private DefaultMutableTreeNode top ;
29
30  /**
31   * Constructor that prepares the modal dialog containing the filled tree control
32   * @param xml    The data to be displayed in the tree
33   * @param parent Parent frame
34   */
35  public XMLTreeDialog( XMLData xml, Frame parent )
36  {
37      // Construct the modal dialog
38      super( parent, "XML tree", true );
39      // Arrange controls in the dialog
40      top = new DefaultMutableTreeNode("root");
41      myTree = new JTree(top);
42      setContentPane( new JScrollPane( myTree ) );
43      // Build up the tree
44      fillTree( top, xml );
45      myTree.expandRow( 0 );
46  }
47
48  /**
49   * Loads the nodes of an XML element under a given tree node
50   * @param node Target tree node
51   * @param elem Source XML element
52   */
53  private void fillTree( DefaultMutableTreeNode node, XMLData elem)
54  {
55      try
56      {
57          // There are several ways to iterate through child elements: either using the
58          // getFirstChild/getNextChild,
59          // or by incrementing an index up to countChildren and calling getChild [as shown
60          // below].
61          // If you only want to get children of one kind, you should use
62          // countChildrenKind/getChildKind,
63          // or provide a kind to the getFirstChild before iterating with the getNextChild.
64          int nSize = elem.countChildren() ;
65          for ( int i = 0 ; i < nSize ; ++i)
66          {
67              // Create a new tree node for each child element, and continue recursively
68              XMLData newElem = elem.getChild(i) ;
69              DefaultMutableTreeNode newNode = new DefaultMutableTreeNode( newElem.getName() )
70              ;
71              node.add( newNode ) ;
72              fillTree( newNode, newElem ) ;
73          }
74      }
75      catch (Exception e)
76      {
77          e.printStackTrace();
78      }
79  }
```



```

74     }
75   }
76
77 }
```

26.4.6 Command Reference

This section lists the names and identifiers of all menu commands that are available within XMLSpy. Every subsection lists the commands from the corresponding top-level menu of XMLSpy. The command tables are organized as follows:

- The "Menu Item" column shows the command's menu text as it appears in XMLSpy, to make it easier for you to identify the functionality behind the command.
- The "Command Name" column specifies the string that can be used to get an icon with the same name from **ActiveXImages** folder of the XMLSpy installation directory.
- The "ID" column shows the numeric identifier of the column that must be supplied as argument to methods which execute or query this command.

To execute a command, use the [XMLSpyControl.Exec¹⁵²⁸](#) or the [XMLSpyControlDocument.Exec¹⁵³⁵](#) methods. To query the status of a command, use the [XMLSpyControl.QueryStatus¹⁵²⁹](#) or [XMLSpyControlDocument.QueryStatus¹⁵³⁵](#) methods.

Depending on the edition of XMLSpy you have installed, some of these commands might not be supported.

26.4.6.1 "File" Menu

The "File" menu has the following commands:

| Menu item | Command name | ID |
|----------------------|------------------|-------|
| New... | ID_FILE_NEW | 57600 |
| Open... | ID_FILE_OPEN | 57601 |
| Reload | IDC_FILE_RELOAD | 34065 |
| Encoding... | IDC_ENCODING | 34061 |
| Close | ID_FILE_CLOSE | 57602 |
| Close All | IDC_CLOSE_ALL | 34050 |
| Close All But Active | IDC_CLOSE_OTHERS | 34271 |
| Save | ID_FILE_SAVE | 57603 |
| Save As... | ID_FILE_SAVE_AS | 57604 |
| Save All | ID_FILE_SAVE_ALL | 34208 |

| Menu item | Command name | ID |
|-----------------|---------------------|-------|
| Send by Mail... | ID_FILE_SEND_MAIL | 57612 |
| Print... | ID_FILE_PRINT | 57607 |
| Print Preview | IDC_PRINT_PREVIEW | 34104 |
| Print Setup... | ID_FILE_PRINT_SETUP | 57606 |
| Recent File | ID_FILE_MRU_FILE1 | 57616 |
| Exit | ID_APP_EXT | 57665 |

26.4.6.2 "Edit" Menu

The "Edit" menu has the following commands:

| Menu item | Command name | ID |
|----------------------------|---------------------------------------|-------|
| Undo | ID_EDIT_UNDO | 57643 |
| Redo | ID_EDIT_REDO | 57644 |
| Cut | ID_EDIT_CUT | 57635 |
| Copy | ID_EDIT_COPY | 57634 |
| Paste | ID_EDIT_PASTE | 57637 |
| Delete | ID_EDIT_CLEAR | 57632 |
| Copy as XML Text | IDC_COPY_AS_XML_TEXT | 33443 |
| Copy as Tab-separated Text | IDC_COPY_AS_STRUCTURED_TEXT | 33442 |
| Copy XPath | IDC_COPY_XPATH | 33444 |
| Copy XPointer | IDC_COPY_XPOINTER | 33445 |
| File Path... | IDC_EDIT_INSERT_PATH_STRING | 34013 |
| XInclude... | IDC_EDIT_INSERT_XINCLUDE_STRING | 34017 |
| Encoded External File... | IDC_EDIT_INSERT_ENCODED_BINARY_STRING | 34273 |
| Pretty-Print | IDC_PRETTY_PRINT | 34101 |
| Strip Whitespaces | IDC_STRIP_WHITESPACES | 34296 |
| Select All | ID_EDIT_SELECT_ALL | 57642 |

| Menu item | Command name | ID |
|-------------------------|------------------------|-------|
| Find... | ID_EDIT_FIND | 57636 |
| Find Next | ID_EDIT_REPEAT | 57640 |
| Replace... | ID_EDIT_REPLACE | 57641 |
| Find in Files... | IDC_FIND_IN_FILES | 34000 |
| Insert/Remove Bookmark | IDC_TOGGLE_BOOKMARK | 34162 |
| Remove All Bookmarks | IDC_REMOVEALLBOOKMARKS | 34132 |
| Go to Next Bookmark | IDC_GOTONEXTBOOKMARK | 34070 |
| Go to Previous Bookmark | IDC_GOTOPREVBOKMARK | 34071 |
| Comment In/Out | IDC_TOGGLE_XML_COMMENT | 34029 |

26.4.6.3 "Project" Menu

The "Project" menu has the following commands:

| Menu item | Command name | ID |
|-----------------------------------|---|-------|
| New Project | IDC_ICPROJECTGUI_NEW | 37200 |
| Open Project... | IDC_ICPROJECTGUI_OPEN | 37201 |
| Reload Project | IDC_ICPROJECTGUI_RELOAD | 37202 |
| Close Project | IDC_ICPROJECTGUI_CLOSE | 37203 |
| Save Project | IDC_ICPROJECTGUI_SAVE | 37204 |
| Save Project As... | IDC_ICPROJECTGUI_SAVE_AS | 37207 |
| Enable Source Control | ID_SCC_ENABLE | 38602 |
| Add Files to Project... | IDC_ICPROJECTGUI_ADD_FILES_TO_PROJECT | 37205 |
| Add Global Resource to Project... | IDC_ICPROJECTGUI_ADD_GLOBAL_RESOURCE_TO_PROJECT | 37239 |
| Add URL to Project... | IDC_ICPROJECTGUI_ADD_URL_TO_PROJECT | 37206 |
| Add Active File to Project | IDC_ICPROJECTGUI_ADD_ACTIVE_FILE_TO_PROJECT | 37208 |

| Menu item | Command name | ID |
|---|--|-------|
| Add Active and Related Files to Project | IDC_ICPROJECTGUI_ADD_ACTIVE_AND_RELATED_FILES_TO_PROJECT | 37209 |
| Add Project Folder to Project... | IDC_ICPROJECTGUI_ADD_FOLDER_TO_PROJECT | 37210 |
| Add External Folder to Project... | IDC_ICPROJECTGUI_ADD_EXT_FOLDER_TO_PROJECT | 37211 |
| Add External Web Folder to Project... | IDC_ICPROJECTGUI_ADD_EXT_URL_FOLDER_TO_PROJECT | 37212 |
| Script settings... | IDC_PROJECT_SCRIPT_SETTINGS | 34136 |
| Properties... | IDC_ICPROJECTGUI_PROJECT_PROPERTIES | 37223 |
| Recent Project | IDC_ICPROJECTGUI_RECENT | 37224 |

26.4.6.4 "XML" Menu

The "XML" menu has the following commands:

| Menu item | Command name | ID |
|------------------------|----------------------------|-------|
| Attribute | IDC_INSERT_ATTRIBUTE | 33449 |
| Element | IDC_INSERT_STRUCT | 33459 |
| Text | IDC_INSERT_TEXT | 33460 |
| CDATA | IDC_INSERT_CDATA | 33450 |
| Comment | IDC_INSERT_COMMENT | 33451 |
| XML | IDC_INSERT_XML | 33461 |
| Processing Instruction | IDC_INSERT_PI | 33458 |
| XInclude... | IDC_INSERT_XINCLUDE | 34019 |
| DOCTYPE | IDC_INSERT_DEF_DOCTYPE | 33453 |
| ExternalID | IDC_INSERT_DEF_EXTERNAL_ID | 33456 |
| ELEMENT | IDC_INSERT_DEF_ELEMENT | 33454 |
| ATTLIST | IDC_INSERT_DEF_ATTLIST | 33452 |
| ENTITY | IDC_INSERT_DEF_ENTITY | 33455 |

| Menu item | Command name | ID |
|--------------------------|-------------------------------|-------|
| NOTATION | IDC_INSERT_DEF_NOTATION | 33457 |
| Encoded External File... | IDC_INSERT_ENCODED_BINARY | 34274 |
| Attribute | IDC_APPEND_ATTRIBUTE | 33415 |
| Element | IDC_APPEND_STRUCT | 33425 |
| Text | IDC_APPEND_TEXT | 33426 |
| CDATA | IDC_APPEND_CDATA | 33416 |
| Comment | IDC_APPEND_COMMENT | 33417 |
| XML | IDC_APPEND_XML | 33427 |
| Processing Instruction | IDC_APPEND_PI | 33424 |
| XInclude... | IDC_APPEND_XINCLUDE | 34026 |
| DOCTYPE | IDC_APPEND_DEF_DOCTYPE | 33419 |
| ExternalID | IDC_APPEND_DEF_EXTERNAL_ID | 33422 |
| ELEMENT | IDC_APPEND_DEF_ELEMENT | 33420 |
| ATTLIST | IDC_APPEND_DEF_ATTLIST | 33418 |
| ENTITY | IDC_APPEND_DEF_ENTITY | 33421 |
| NOTATION | IDC_APPEND_DEF_NOTATION | 33423 |
| Encoded External File... | IDC_APPEND_ENCODED_BINARY | 34276 |
| Attribute | IDC_ADD_CHILD_ATTRIBUTE | 33402 |
| Element | IDC_ADD_CHILD_STRUCT | 33412 |
| Text | IDC_ADD_CHILD_TEXT | 33413 |
| CDATA | IDC_ADD_CHILD_CDATA | 33403 |
| Comment | IDC_ADD_CHILD_COMMENT | 33404 |
| XML | IDC_ADD_CHILD_XML | 33414 |
| Processing Instruction | IDC_ADD_CHILD_PI | 33411 |
| XInclude... | IDC_ADD_CHILD_XINCLUDE | 34027 |
| DOCTYPE | IDC_ADD_CHILD_DEF_DOCTYPE | 33406 |
| ExternalID | IDC_ADD_CHILD_DEF_EXTERNAL_ID | 33409 |
| ELEMENT | IDC_ADD_CHILD_DEF_ELEMENT | 33407 |

| Menu item | Command name | ID |
|--------------------------|--------------------------------|-------|
| ATTLIST | IDC_ADD_CHILD_DEF_ATTLIST | 33405 |
| ENTITY | IDC_ADD_CHILD_DEF_ENTITY | 33408 |
| NOTATION | IDC_ADD_CHILD_DEF_NOTATION | 33410 |
| Encoded External File... | IDC_ADD_CHILD_ENCODED_BINARY | 34277 |
| Attribute | IDC_CONVERT_TO_ATTRIBUTE | 33429 |
| Element | IDC_CONVERT_TO_STRUCT | 33439 |
| Text | IDC_CONVERT_TO_TEXT | 33440 |
| CDATA | IDC_CONVERT_TO_CDATA | 33430 |
| Comment | IDC_CONVERT_TO_COMMENT | 33431 |
| XML | IDC_CONVERT_TO_XML | 33441 |
| Processing Instruction | IDC_CONVERT_TO_PI | 33438 |
| DOCTYPE | IDC_CONVERT_TO_DEF_DOCTYPE | 33433 |
| ExternalID | IDC_CONVERT_TO_DEF_EXTERNAL_ID | 33436 |
| ELEMENT | IDC_CONVERT_TO_DEF_ELEMENT | 33434 |
| ATTLIST | IDC_CONVERT_TO_DEF_ATTLIST | 33432 |
| ENTITY | IDC_CONVERT_TO_DEF_ENTITY | 33435 |
| NOTATION | IDC_CONVERT_TO_DEF_NOTATION | 33437 |
| Display as Table | IDC_GRID_VIEW_AS_TABLE | 34075 |
| Insert Row | IDC_TABLE_INSERT_ROW | 34158 |
| Append Row | IDC_TABLE_APPEND_ROW | 34157 |
| Ascending Sort | IDC_TABLE_SORT_ASC | 33464 |
| Descending Sort | IDC_TABLE_SORT_DESC | 33465 |
| Move Left | IDC_MOVE_LEFT | 34091 |
| Move Right | IDC_MOVE_RIGHT | 34092 |
| Enclose in Element | IDC_ENCLOSE_IN_ELEMENT | 33446 |
| Evaluate XPath... | IDC_EVALUATE_XPATH | 34007 |
| Check Well-Formedness | IDC_CHECK_WELL_FORM | 34049 |
| Validate XML | IDC_VALIDATE | 32954 |

| Menu item | Command name | ID |
|---|---------------------------|-------|
| Validate XML on Server (high-performance) | IDC_VALIDATE_RAPTOR | 34309 |
| Update Entry Helpers | IDC_UPDATE_ELEMENT_CHOICE | 34173 |
| Namespace Prefix... | IDC_NAMESPACE | 33462 |
| Create XML Signature... | IDC_XML_SIGNATURE_CREATE | 34280 |
| Verify XML Signature... | IDC_XML_SIGNATURE_VERIFY | 34281 |

26.4.6.5 "DTD/Schema" Menu

The "DTD/Schema" menu has the following commands:

| Menu item | Command name | ID |
|---|-------------------------------|-------|
| Assign DTD... | IDC_ASSIGN_DTD | 34032 |
| Assign Schema... | IDC_ASSIGN_SCHEMA | 34033 |
| Include Another DTD... | IDC_INCLUDE_DTD | 34084 |
| Go to DTD | IDC_GOTO_DTD | 34072 |
| Go to Schema | IDC_GOTO_SCHEMA | 34074 |
| Go to Definition | IDC_GOTO_DEFINITION | 33447 |
| Generate DTD/Schema... | IDC_GENERATE_DTD_SCHEMA | 34068 |
| Flatten DTD... | IDC_FLATTEN_DTD | 34301 |
| Convert DTD To Schema... | IDC_CONVERT_DTD_TO_SCHEMA | 34299 |
| Flatten Schema... | IDC_FLATTEN_SCHEMA | 34302 |
| Convert Schema To DTD... | IDC_CONVERT_SCHEMA_TO_DTD | 34300 |
| Convert to UML... | IDC_CONVERT_SCHEMA_TO_UML | 34008 |
| Generate XML from DB, Excel, EDI with MapForce... | IDC_DTD_OPENIN_MAPFORCE | 34056 |
| Design HTML/PDF/Word Output with StyleVision... | IDC_DTD_OPENIN_STYLEVISION | 34057 |
| Generate Sample XML/JSON File... | IDC_GENERATE_XML_FROM_SCHEMA | 34069 |
| Generate Program Code... | IDC_GENERATE_CODE_FROM_SCHEMA | 34067 |
| Flush Memory Cache | IDC_FLUSH_CACHED_FILES | 34066 |

26.4.6.6 "Schema design" Menu

The "Schema design" menu has the following commands:

| Menu item | Command name | ID |
|--|--|-------|
| Schema Settings... | IDC_SCHEMA_NAMESPACES | 33571 |
| Save Diagram... | IDC_SCHEMA_SAVE_DIAGRAM | 33581 |
| Generate Documentation... | IDC_SCHEMA_DOCUMENTATION | 34146 |
| Configure View... | IDC_SCHEMA_VIEW_CONFIG | 33593 |
| Zoom... | IDC_SCHEMA_ZOOM | 34150 |
| Display All Globals | IDC_SCHEMA_MODE_GLOBALS | 34147 |
| Display Diagram | IDC_SCHEMA_MODE_DIAGRAM | 33570 |
| Enable Oracle Schema Extensions | IDC_SCHEMA_ORACLE_EXTENSIONS | 33577 |
| Oracle Schema Settings... | IDC_SCHEMA_ORACLE_SCHEMA_SETTING
S | 33578 |
| Enable Microsoft SQL Server Schema Extensions | IDC_SCHEMA_SQLSERVER_EXTENSIONS | 33588 |
| Named Schema Relationships... | IDC_SCHEMA_SQLSERVER_GLOBAL_RELA
TIONSHPIS | 33589 |
| Unnamed Element Relationships... | IDC_SCHEMA_SQLSERVER_LOCAL_RELATI
ONSHIPS | 33590 |
| Connect to SchemaAgent Server... | IDC_SCHEMA_SCHEMAAGENT_SERVER_C
ONNECT | 33582 |
| Disconnect from SchemaAgent Server | IDC_SCHEMA_SCHEMAAGENT_SERVER_DI
SCONNECT | 33583 |
| File Only | IDC_SCHEMAAGENT_SHOW_FILE_ONLY | 33504 |
| File and All Directly Referenced Schema Files | IDC_SCHEMAAGENT_SHOW_WITH_DIRECTL
Y_REFERENCED_SCHEMAS | 33608 |
| File and All Directly Referencing Schema Files | IDC_SCHEMAAGENT_SHOW_WITH_DIRECTL
Y_REFERENCING_SCHEMAS | 33602 |
| File and All Directly Related Schema Files | IDC_SCHEMAAGENT_SHOW_WITH_DIRECTL
Y_RELATED_SCHEMAS | 33613 |
| SchemaAgent Validation... | IDC_SCHEMA_EXTVALID_MENU | 33539 |

| Menu item | Command name | ID |
|-------------------------|--------------------------|-------|
| Create Schema Subset... | IDC_SCHEMA_CREATE_SUBSET | 33650 |
| Flatten Schema... | IDC_SCHEMA_FLATTEN | 33651 |

26.4.6.7 "XSL/XQuery" Menu

The "XSL/XQuery" menu has the following commands:

| Menu item | Command name | ID |
|--------------------------------------|--|-------|
| XSL Transformation | IDC_TRANSFORM_XSL | 33006 |
| XSL Speed Optimizer | IDC_TRANSFORM_XSLPBO | 34306 |
| XSL-FO Transformation | IDC_TRANSFORM_XSLFO | 33007 |
| XSL Parameters / XQuery Variables... | IDC_TRANSFORM_XSL_PARAMS | 33008 |
| XQuery/Update Execution | IDC_TRANSFORM_XQUERY | 34170 |
| Enable Back Mapping | IDC_ENABLE_BACKMAPPING | 34364 |
| Enable XSLT/ XQuery Profiling.... | IDC_PROFILING_OPTIONS | 34105 |
| Assign XSL... | IDC_ASSIGN_XSL | 33001 |
| Assign XSL-FO... | IDC_ASSIGN_XSLFO | 33002 |
| Assign Sample XML File... | IDC_ASSIGN_SAMPLE_XML | 33000 |
| Go to XSL | IDC_GOTO_XSL | 33004 |
| Start Debugger / Go | ID_PROCESS_XSL | 34212 |
| Stop Debugger | ID_XSLT_DEBUGGER_STOP | 33017 |
| Restart Debugger | ID_XSLT_DEBUGGER_RESTART | 33013 |
| End Debugger Session | ID_XSLT_DEBUGGER_END_SESSION | 33011 |
| Step Into | ID_XSLT_DEBUGGER_STEP | 33014 |
| Step Out | ID_XSLT_DEBUGGER_STEP_OUT | 33015 |
| Step Over | ID_XSLT_DEBUGGER_STEP_OVER | 33016 |
| Show Current Execution Node | ID_XSLT_DEBUGGER_GO_TO_CURRENT_EXECUTION_NODES | 33012 |
| Insert/Remove Breakpoint | IDC_TOGGLE_BREAKPOINT | 34246 |

| Menu item | Command name | ID |
|----------------------------|--------------------------------|-------|
| Insert/Remove Tracepoint | IDC_TOGGLE_TRACEPOINT | 34248 |
| Enable/Disable Breakpoint | IDC_ENABLE_BREAKPOINT | 34245 |
| Enable/Disable Tracepoint | IDC_ENABLE_TRACEPOINT | 34247 |
| Breakpoints/Tracepoints... | ID_XSLTDEBUGGER_BREAKPOINTS | 33009 |
| Call Stack | ID_XSL_DEBUGWINDOWS_CALLSTACK | 34238 |
| XPath-Watch | ID_XSL_DEBUGWINDOWS_WATCH | 34244 |
| Context | ID_XSL_DEBUGWINDOWS_CONTEXT | 34239 |
| Variables | ID_XSL_DEBUGWINDOWS_VARIABLE | 34243 |
| Messages | ID_XSL_DEBUGWINDOWS_MESSAGES | 34240 |
| Templates | ID_XSL_DEBUGWINDOWS_TEMPLATES | 34241 |
| Info | ID_XSLXQUERY_DEBUGWINDOWS_INFO | 34237 |
| Trace | ID_XSL_DEBUGWINDOWS_TRACES | 34242 |
| Debug Settings... | ID_XSLTDEBUGGER_SETTINGS | 33010 |

26.4.6.8 "Authentic" Menu

The "Authentic" menu has the following commands:

| Menu item | Command name | ID |
|---|--------------------------------|-------|
| New Document... | IDC_AUTHENTIC_NEW_FILE | 34036 |
| Edit Database Data... | IDC_AUTHENTIC_EDIT_DB | 34035 |
| Assign a StyleVision Stylesheet... | IDC_ASSIGN_SPS | 34034 |
| Edit StyleVision Stylesheet | IDC_EDIT_SPS | 34060 |
| Select New Row with XML Data for Editing... | IDC_CHANGE_WORKING_DB_XML_CELL | 32861 |
| XML Signature... | IDC_AUTHENTICGUI_XMLSIGNATURE | 32862 |
| Define XML Entities... | IDC_DEFINE_ENTITIES | 32805 |
| Hide Markup | IDC_MARKUP_HIDE | 32855 |
| Show Small Markup | IDC_MARKUP_SMALL | 32858 |
| Show Large Markup | IDC_MARKUP_LARGE | 32856 |

| Menu item | Command name | ID |
|--------------------------------|---|-------|
| Show Mixed Markup | IDC_MARKUP_MIXED | 32857 |
| Toggle Bold | IDC_AUTHENTICGUI_RICHEDIT_TOGGLEBOLD | 32813 |
| Toggle Italic | IDC_AUTHENTICGUI_RICHEDIT_TOGGLEITALIC | 32814 |
| Toggle Underline | IDC_AUTHENTICGUI_RICHEDIT_TOGGLEUNDERLINE | 32815 |
| Toggle Strikethrough | IDC_AUTHENTICGUI_RICHEDIT_TOGGLESTRIKETHROUGH | 32816 |
| Foreground Color | IDC_AUTHENTICGUI_RICHEDIT_COLOR_FOREGROUND | 32824 |
| Background Color | IDC_AUTHENTICGUI_RICHEDIT_COLOR_BACKGROUND | 32830 |
| Align Left | IDC_AUTHENTICGUI_RICHEDIT_ALIGN_LEFT | 32818 |
| Center | IDC_AUTHENTICGUI_RICHEDIT_ALIGN_CENTER | 32819 |
| Align Right | IDC_AUTHENTICGUI_RICHEDIT_ALIGN_RIGHT | 32820 |
| Append Row | IDC_ROW_APPEND | 32806 |
| Insert Row | IDC_ROW_INSERT | 32809 |
| Duplicate Row | IDC_ROW_DUPLICATE | 32808 |
| Move Row Up | IDC_ROW_MOVE_UP | 32811 |
| Move Row Down | IDC_ROW_MOVE_DOWN | 32810 |
| Delete Row | IDC_ROW_DELETE | 32807 |
| Generate an HTML document | IDC_PXF_GENERATE_HTML | 34283 |
| Generate an RTF document | IDC_PXF_GENERATE_RTF | 34284 |
| Generate a PDF document | IDC_PXF_GENERATE_PDF | 34285 |
| Generate a Word 2007+ document | IDC_PXF_GENERATE_DOCX | 34286 |
| Generate a Text document | IDC_PXF_GENERATE_TEXT | |
| Trusted Locations... | IDC_TRUSTED_LOCATIONS | 34288 |

26.4.6.9 "DB" Menu

The "DB" menu has the following commands:

| Menu item | Command name | ID |
|--------------------------------|--------------------------------|-------|
| Query Database | IDC_QUERYDATABASE | 34012 |
| Manage XML Schemas... | IDC_DB_MANAGESCHEMAS | 34014 |
| Assign XML Schema... | IDC_DB_CHOOOSEVALIDATIONSCHEMA | 34016 |
| Manage XML Schemas... | IDC_DB_MANAGESCHEMAS | 34014 |
| Manage XML Schemas... | IDC_DB_MANAGESCHEMAS | 34014 |
| Browse Oracle XML Documents... | ID_CONVERT_ORACLEXMLDB_BROWSE | 34205 |

26.4.6.10 "Convert" Menu

The "Convert" menu has the following commands:

| Menu item | Command name | ID |
|---|-------------------------------|-------|
| Import Text File... | IDC_IMPORT_TEXT | 34082 |
| Import Database Data... | IDC_IMPORT_DATABASE | 34080 |
| Import Microsoft Word Document... | IDC_IMPORT_WORD | 34083 |
| Create XML Schema from DB Structure | IDC_CREATE_DB_SCHEMA | 34054 |
| DB Import Based on XML Schema | IDC_IMPORT_DB_SCHEMA | 34081 |
| Create DB Structure from XML Schema | IDC_CREATE_DB_BASED_ON_SCHEMA | 34053 |
| Export to Text Files... | IDC_EXPORT_TEXTFILE | 34064 |
| Export to a Database... | IDC_EXPORT_DB | 34003 |
| Convert XML Instance to/from JSON... | IDC_JSON_CONVERT_TOFROM_XML | 34135 |
| Convert XML Schema to/from JSON Schema... | IDC_JSON_CONVERT_TOFROM_XSD | 34350 |

26.4.6.11 "View" Menu

The "View" menu has the following commands:

| Menu item | Command name | ID |
|----------------------|-------------------------|-------|
| Text View | IDC_VIEW_TEXT | 34180 |
| Enhanced Grid View | IDC_VIEW_GRID | 34178 |
| Schema Design View | IDC_VIEW_SCHEMA | 34179 |
| WSDL Design View | IDC_VIEW_WSDL | 34117 |
| XBRL Taxonomy View | IDC_VIEW_XBRL | 34118 |
| Authentic View | IDC_VIEW_CONTENT | 34177 |
| Browser View | IDC_VIEW_BROWSER | 34176 |
| Expand + | IDC_SEL_EXPAND | 34152 |
| Collapse - | IDC_SEL_COLLAPSE | 34151 |
| Expand Fully | IDC_SEL_EXPAND_ALL | 33463 |
| Collapse Unselected | IDC_COLLAPSE_UNSELECTED | 33428 |
| Optimal Widths | IDC_OPTIMAL_WIDTHS | 34099 |
| Word Wrap | IDC_WORD_WRAP | 34181 |
| Go to Line/Character | IDC_GOTO_LINE | 34073 |
| Go to File | IDC_GOTO_FILE | 33448 |
| Text View Settings | IDC_TEXTVIEW_SETTINGS | 34119 |

26.4.6.12 "Browser" Menu

The "Browser" menu has the following commands:

| Menu item | Command name | ID |
|-----------|--------------------------|-------|
| Back | IDC_STEP_BACK | 32958 |
| Forward | IDC_STEP_FORWARD | 32957 |
| Stop | IDC_BROWSER_STOP | 34047 |
| Refresh | IDC_BROWSER_REFRESH | 34046 |
| Largest | IDC_BROWSER_FONT_LARGEST | 34041 |
| Larger | IDC_BROWSER_FONT_LARGE | 34040 |
| Medium | IDC_BROWSER_FONT_MEDIUM | 34042 |

| Menu item | Command name | ID |
|-----------|---------------------------|-------|
| Smaller | IDC_BROWSER_FONT_SMALL | 34043 |
| Smallest | IDC_BROWSER_FONT_SMALLEST | 34044 |

26.4.6.13 "WSDL" Menu

The "WSDL" menu has the following commands:

| Menu item | Command name | ID |
|-----------------------------------|--|-------|
| Insert Message | ID_WSDL_MESSAGES_ADDNEWMESSAGE | 33715 |
| Delete Message | ID_WSDL_MESSAGES_DELETESELECTEDMESSAGE | 33717 |
| Add Message Part (Parameter) | ID_WSDL_MESSAGES_ADDMESSAGEPART | 33714 |
| Delete Message Part (Parameter) | ID_WSDL_MESSAGES_DELETEMESSAGEPART | 33716 |
| request-response | IDC_WSDL_OPERATION_APPENDREQUESTRESPONSE | 33734 |
| solicit-response | IDC_WSDL_OPERATION_APPENDSOLICITRESPONSE | 33737 |
| one-way | IDC_WSDL_OPERATION_APPENDONEWAY | 33735 |
| notification | IDC_WSDL_OPERATION_APPENDNOTIFICATION | 33736 |
| Empty Operation | ID_WSDL_OPERATIONS_APPENDAOPERATIONTOHISPORTTYPE | 33722 |
| Delete Operation | ID_WSDL_OPERATIONS_DELETEOPERATION | 33724 |
| Add Input Element | ID_WSDL_OPERATIONS_ADDINPUTFUNCTION | 33719 |
| Add Output Element | ID_WSDL_OPERATIONS_ADDOUTPUTFUNCTION | 33721 |
| Add Fault Element | ID_WSDL_OPERATIONS_ADDFAULTFUNCTION | 33718 |
| Delete Input/Output/Fault Element | ID_WSDL_OPERATIONS_DELETEINPUTOUTPUTFUNCTION | 33723 |

| Menu item | Command name | ID |
|---|--|-------|
| Add New Message to Input/Output/Fault Element | ID_WSDL_OPERATIONS_ADDNEWMESSAG
ETOTHISELEMENT | 33720 |
| Insert Port Type | ID_WSDL_PORTTYPE_INSERTAPORTTYPE | 33727 |
| Delete Port Type | ID_WSDL_PORTTYPE_DELETETHISPORTTY
PE | 33726 |
| Insert Binding | ID_WSDL_BINDING_NEWBINDING | 33713 |
| Delete Binding | ID_WSDL_BINDING_DELETEBINDING | 33711 |
| soap:body | ID_WSDL_BINDING_APPENDEXTENSIBILITY_
SOAPBODY | 33706 |
| soap:header | ID_WSDL_BINDING_APPENDEXTENSIBILITY_
SOAPHEADER | 33708 |
| soap:headerfault | ID_WSDL_BINDING_APPENDEXTENSIBILITY_
SOAPHEADERFAULT | 33709 |
| soap:fault | ID_WSDL_BINDING_APPENDEXTENSIBILITY_
SOAPFAULT | 33707 |
| mime:content | ID_WSDL_BINDING_APPENDEXTENSIBILITY_
MIMECONTENT | 33702 |
| mime:multipartrelated | ID_WSDL_BINDING_APPENDEXTENSIBILITY_
MIMEMULTIPARTRELATED | 33704 |
| mime:part | ID_WSDL_BINDING_APPENDEXTENSIBILITY_
MIMEPART | 33705 |
| mime:mimeXml | ID_WSDL_BINDING_APPENDEXTENSIBILITY_
MIMEMIMEXML | 33703 |
| http:urlencoded | ID_WSDL_BINDING_APPENDEXTENSIBILITY_
HTTPURLENCODED | 33700 |
| http:urlreplacement | ID_WSDL_BINDING_APPENDEXTENSIBILITY_
HTTPURLREPLACEMENT | 33701 |
| Delete Extensibility Element | ID_WSDL_BINDING_DELETEEXTENSIBILITY | 33712 |
| Insert Service | ID_WSDL_SERVICE_INSERTSERVICE | 33731 |
| Delete Service | ID_WSDL_SERVICE_DELETETHISSERVICE | 33729 |
| Insert Port | ID_WSDL_SERVICE_INSERTNEWPORT | 33730 |
| Delete Port | ID_WSDL_SERVICE_DELETETHISPORT | 33728 |
| Add New Interface | IDC_WSDL20_ADDINTERFACE | 33794 |

| Menu item | Command name | ID |
|-------------------|--|-------|
| Delete Interface | IDC_WSDL20_DELETEINTERFACE | 33795 |
| Add New Fault | IDC_WSDL20_ADDINTERFACEFAULT | 33796 |
| Delete Fault | IDC_WSDL20_DELETEINTERFACEFAULT | 33808 |
| In-only | IDC_WSDL20_ADDINTERFACEOPERATION_I
ONLY | 33797 |
| Robust-in-only | IDC_WSDL20_ADDINTERFACEOPERATION_
ROBUSTINONLY | 33798 |
| In-out | IDC_WSDL20_ADDINTERFACEOPERATION_I
NOUT | 33801 |
| In-opt-out | IDC_WSDL20_ADDINTERFACEOPERATION_I
NOPTOUT | 33802 |
| Out-in | IDC_WSDL20_ADDINTERFACEOPERATION_
OUTIN | 33803 |
| Out-opt-in | IDC_WSDL20_ADDINTERFACEOPERATION_
OUTOPTIN | 33804 |
| Out-only | IDC_WSDL20_ADDINTERFACEOPERATION_
OUTONLY | 33800 |
| Robust-out-only | IDC_WSDL20_ADDINTERFACEOPERATION_
ROBUSTOUTONLY | 33799 |
| Empty Operation | IDC_WSDL20_ADDINTERFACEOPERATION_
EMPTY | 33805 |
| Delete Operation | IDC_WSDL20_DELETEINTERFACEOPERATIO
N | 33809 |
| Add New Binding | IDC_WSDL20_ADDBINDING | 33820 |
| Delete Binding | IDC_WSDL20_DELETEBINDING | 33821 |
| Add New Fault | IDC_WSDL20_ADDBINDINGFAULT | 33822 |
| Delete Fault | IDC_WSDL20_DELETEBINDINGFAULT | 33826 |
| Add New Operation | IDC_WSDL20_ADDBINDINGOPERATION | 33823 |
| Delete Operation | IDC_WSDL20_DELETEBINDINGOPERATION | 33827 |
| Add New Service | IDC_WSDL20_ADDSERVICE | 33839 |
| Delete Service | IDC_WSDL20_DELETESERVICE | 33840 |
| Add New Endpoint | IDC_WSDL20_ADDENDPOINT | 33841 |

| Menu item | Command name | ID |
|---|---------------------------------|-------|
| Delete Endpoint | IDC_WSDL20_DELETEENDPOINT | 33842 |
| New Schema | ID_WSDL_TYPES_NEWSHEMA | 33733 |
| Embed Schema | ID_WSDL_TYPES_EMBEDSCHEMA | 39456 |
| Extract Schema(s) | ID_WSDL_TYPES_EXTRACTSCHEMAS | 39459 |
| Edit Schema(s) in Schema View | ID_WSDL_TYPES_EDITTHISSHEMA | 33732 |
| Save Diagram... | IDC_WSDL_SAVE_DIAGRAM | 39451 |
| Generate Documentation... | ID_WSDL_GENERATEDOCUMENTATION | 39452 |
| Reparse WSDL Document | IDC_WSDL_REPARSE | 33774 |
| Convert to WSDL 2.0 | IDC_WSDL_CONVERT_TO_WSDL20 | 39453 |
| Generate WSDL Program Code with MapForce... | IDC_WSDL_GENERATE_CODE_MAPFORCE | 34122 |

26.4.6.14 "SOAP" Menu

The "SOAP" menu has the following commands:

| Menu item | Command name | ID |
|----------------------------|-------------------------------------|-------|
| Create New SOAP Request... | ID_SOAP_GENERATESOAPMESSAGE | 34224 |
| Send Request to Server... | ID_SOAP_SENDDREQUESTTOSERVER | 34225 |
| SOAP Request Settings... | ID_SOAP_SOAPREQUESTSETTINGS | 34227 |
| Soap Debugger Session | ID_SOAP_SOAPDEBUGGER | 34226 |
| Go | ID_SOAPDEBUGGER_BUTTONPLAY | 34221 |
| Single Step | ID_SOAPDEBUGGER_SINGLESTEP | 34222 |
| Break on Next Request | ID_SOAPDEBUGGER_BREAKONNEXTREQUEST | 34219 |
| Break on Next Response | ID_SOAPDEBUGGER_BREAKONNEXTRESPONSE | 34220 |
| Stop the Proxy Server | ID_SOAPDEBUGGER_STOPSERVER | 34223 |
| Soap Debugger Options | ID_SOAPDEBUGGEROPTIONS | 34218 |

26.4.6.15 "XBRL" Menu

The "XBRL" menu has the following commands:

| Menu item | Command name | ID |
|--|--|-------|
| Arcroles... | IDC_XMLSPYXBREEDITOR_ARCROLES | 34114 |
| Linkroles... | IDC_XMLSPYXBREEDITOR_LINKROLES | 34115 |
| Namespace Prefixes... | IDC_XMLSPYXBREEDITOR_NAMESPACES | 34116 |
| Set Target Namespace... | IDC_XMLSPYXBREEDITOR_SET_TARGETNAMESPACE | 34039 |
| Parameter Values... | IDC_ICXBREEDITOR_PARAMETER_VALUES | 38913 |
| Import/Reference... | IDC_XMLSPYXBREEDITOR_IMPORT_REFERENCE | 34137 |
| Find Component By Id... | IDC_ICXBREEDITOR_FIND_COMPONENT_BY_ID | 38893 |
| Generate Documentation... | IDC_XMLSPYXBREEDITOR_GENERATEDOCUMENTATION | 34125 |
| View Settings... | IDC_XMLSPYXBREEDITOR_VIEWSETTINGS | 34113 |
| Generate XBRL from DB, Excel, CSV with MapForce... | IDC_XBRL_GENERATE_WITH_MAPFORCE | 34045 |
| Present XBRL as HTML/PDF/Word with StyleVision... | IDC_XBRL_PRESENT_WITH_STYLEVISION | 34121 |
| Execute Formula... | IDC_XBRL_EXECUTE_FORMULA | 34305 |
| Execute Formula on Server (high-performance)... | IDC_XBRL_EXECUTE_FORMULA_RAPTOR | 34352 |
| Generate Table... | IDC_XBRL_GENERATE_TABLE | 34304 |
| Generate Table on Server (high-performance)... | IDC_XBRL_GENERATE_TABLE_RAPTOR | 34353 |
| Transform Inline XBRL | IDC_IXBRL_TRANSFORM | 34354 |

26.4.6.16 "Tools" Menu

The "Tools" menu has the following commands:

| Menu item | Command name | ID |
|---------------------------|--|-------|
| Spelling... | IDC_SPELL_CHECK | 34154 |
| Spelling Options... | IDC_SPELL_OPTIONS | 34155 |
| Scripting Editor... | ID_SCRIPTFORMEDITOR_EDIT_PROJECT | 39666 |
| none | ID_SCRIPTFORMEDITOR_EXECUTE_MACRO_MENU_UPPDATE | 39600 |
| Compare Open File With... | ID_XMLDIFF_CHOOSE_FILES | 34235 |
| Compare Directories... | ID_XMLDIFF_CHOOSE_DIRECTORIES | 34234 |
| Compare Options... | ID_XMLDIFF_SETTINGS | 34236 |
| | IDC_TOOLS_ENTRY | 34292 |
| Global Resources | IDC_GLOBALRESOURCES | 37401 |
| | IDC_GLOBALRESOURCES_SUBMENUENTR Y1 | 37408 |
| Manage Raptor Servers ... | IDC_VALIDATE_RAPTOR_MANAGER | 34311 |
| none | IDC_VALIDATE_RAPTOR_NOCFG | 34326 |
| Customize... | IDC_APP_TOOLS_CUSTOMIZE | 32959 |
| Options... | IDC_SETTINGS | 34133 |
| | ID_SCRIPTING_MACROITEMS | 34249 |

26.4.6.17 "Window" Menu

The "Window" menu has the following commands:

| Menu item | Command name | ID |
|-------------------|-----------------------|-------|
| Cascade | ID_WINDOW_CASCADE | 57650 |
| Tile horizontally | ID_WINDOW_TILE_HORZ | 57651 |
| Tile vertically | ID_WINDOW_TILE_VERT | 57652 |
| Project window | IDC_PROJECT_WINDOW | 34128 |
| Info window | IDC_INFO_WINDOW | 34085 |
| Entry Helpers | IDC_ENTRY_HELPERS | 34062 |
| Output windows | IDC_OUTPUT_DIALOGBARS | 34004 |

| Menu item | Command name | ID |
|---------------------------|--------------------------|-------|
| Project and Entry Helpers | IDC_PROJECT_ENTRYHELPERS | 34006 |
| All on/off | IDC_ALL_BARS | 34031 |

26.4.6.18 "Help" Menu

The "Help" menu has the following commands:

| Menu item | Command name | ID |
|---------------------------------------|--------------------------|-------|
| Table of Contents... | IDC_HELP_CONTENTS | 32966 |
| Index... | IDC_HELP_INDEX | 32967 |
| Search... | IDC_HELP_SEARCH | 32969 |
| Keyboard Map... | IDC_HELP_KEYMAPDLG | 32968 |
| Software Activation... | IDC_ACTIVATION | 32970 |
| Order Form... | IDC_OPEN_ORDER_PAGE | 32971 |
| Registration... | IDC_REGISTRATION | 32972 |
| Check for Updates... | IDC_CHECK_FOR_UPDATES | 32973 |
| XMLSpy Product Comparison... | IDC_PRODUCT_COMPARISON | 32955 |
| Support Center... | IDC_OPEN_SUPPORT_PAGE | 32961 |
| FAQ on the Web... | IDC_OPEN_FAQ_PAGE | 32962 |
| Download Components and Free Tools... | IDC_OPEN_COMPONENTS_PAGE | 32963 |
| Authentic on the Internet.. | IDC_OPEN_HOME_PAGE | 32964 |
| Authentic Training... | IDC_OPEN_TRAINING_PAGE | 32965 |
| About XMLSpy... | ID_APP_ABOUT | 57664 |

26.4.7 Object Reference

Objects:

[XMLSpyCommand](#) ¹⁵²¹

[XMLSpyCommands](#) ¹⁵²³

[XMLSpyControl](#) ¹⁵²⁴

[XMLSpyControlDocument](#) ¹⁵³²

[XMLSpyControlPlaceHolder](#)¹⁵³⁹

To give access to standard XMLSpy functionality, objects of the **XMLSpy automation interface** can be accessed as well. See [XMLSpyControl.Application](#)¹⁵²⁵, [XMLSpyControlDocument.Document](#)¹⁵³³ and [XMLSpyControlPlaceHolder.Project](#)¹⁵⁴⁰ for more information.

26.4.7.1 XMLSpyCommand

Properties:

- [ID](#)¹⁵²²
- [Label](#)¹⁵²²
- [Name](#)¹⁵²²
- [IsSeparator](#)¹⁵²²
- [ToolTip](#)¹⁵²³
- [StatusText](#)¹⁵²²
- [Accelerator](#)¹⁵²¹
- [SubCommands](#)¹⁵²³

Description:

A command object can be one of the following: an executable command, a command container (for example, a menu, submenu, or toolbar), or a menu separator. To determine what kind of information is stored in the current Command object, query its ID, IsSeparator, and SubCommands properties, as follows.

| The Command object is... | When... |
|--------------------------|---|
| An executable command | <ul style="list-style-type: none"> • ID is greater than zero • IsSeparator is false • SubCommands is empty |
| A command container | <ul style="list-style-type: none"> • ID is zero • IsSeparator is false • SubCommands contains a collection of Command objects. |
| Separator | <ul style="list-style-type: none"> • ID is zero • IsSeparator is true |

26.4.7.1.1 Accelerator

Property: Accelerator as `string`

Description:

Returns the accelerator key defined for the command. If the command has no accelerator key assigned, this property returns the empty string. The string representation of the accelerator key has the following format:

[ALT+] [CTRL+] [SHIFT+] key

Where `key` is converted using the Windows Platform SDK function `GetKeyNameText`.

26.4.7.1.2 ID

Property: ID as `long`

Description:

This property gets the unique identifier of the command. A command's ID is required to execute the command (using [Exec](#)¹⁵²⁸) or query its status (using [QueryStatus](#)¹⁵²⁹). If the command is a container for other commands (for example, a top-level menu), or a separator, the ID is 0.

26.4.7.1.3 IsSeparator

Property: IsSeparator as `boolean`

Description:

The property returns `true` if the command object is a menu separator; `false` otherwise. See also [Command](#)¹⁵²¹.

26.4.7.1.4 Label

Property: Label as `string`

Description:

This property gets the text of the command as it is displayed in the graphical user interface of XMLSpy. If the command is a separator, "Label" is an empty string. This property may also return an empty string for some toolbar commands that do not have any GUI text associated with them.

26.4.7.1.5 Name

Property: Name as `string`

Description:

This property gets the unique name of the command. This value can be used to get the icon file of the command, where it is available. The available icon files can be found in the folder `<ApplicationFolder>\ExamplesActiveX\Images` of your XMLSpy installation.

26.4.7.1.6 StatusText

Property: Label as `string`

Description:

The status text is the text shown in the status bar of XMLSpy when the command is selected. It applies only to command objects that are not separators or containers of other commands; otherwise, the property is an empty string.

26.4.7.1.7 SubCommands

Property: SubCommands as [Commands](#)¹⁵²³

Description:

The SubCommands property gets the collection of [Command](#)¹⁵²¹ objects that are sub-commands of the current command. The property is applicable only to commands that are containers for other commands (menus, submenus, or toolbars). Such container commands have the ID set to 0, and the IsSeparator property set to false.

26.4.7.1.8 ToolTip

Property: ToolTip as `string`

Description:

This property gets the text that is shown as a tool-tip for each command. If the command does not have a tooltip text, the property returns an empty string.

26.4.7.2 XMLSpyCommands

Properties:

[Count](#)¹⁵²³
[Item](#)¹⁵²⁴

Description:

Collection of [Command](#)¹⁵²¹ objects to get access to command labels and IDs of the XMLSpyControl. Those commands can be executed with the [Exec](#)¹⁵²⁶ method and their status can be queried with [QueryStatus](#)¹⁵²⁹.

26.4.7.2.1 Count

Property: Count as `long`

Description:

Number of [Command](#)¹⁵²¹ objects on this level of the collection.

26.4.7.2.2 Item

Property: Item (n as long) as [Command](#) ¹⁵²¹

Description:

Gets the command with the index n in this collection. Index is 1-based.

26.4.7.3 XMLSpyControl

Properties:

[IntegrationLevel](#) ¹⁵²⁶
[Appearance](#) ¹⁵²⁵
[Application](#) ¹⁵²⁵
[BorderStyle](#) ¹⁵²⁵
[CommandsList](#) ¹⁵²⁵
[EnableUserPrompts](#) ¹⁵²⁶
[MainMenu](#) ¹⁵²⁶
[Toolbars](#) ¹⁵²⁷

Methods:

[Open](#) ¹⁵²⁸
[Exec](#) ¹⁵²⁸
[QueryStatus](#) ¹⁵²⁹

Events:

[OnUpdateCmdUI](#) ¹⁵³¹
[OnOpenedOrFocused](#) ¹⁵³¹
[OnCloseEditingWindow](#) ¹⁵²⁹
[OnFileChangedAlert](#) ¹⁵³⁰
[OnContextChanged](#) ¹⁵³⁰
[OnDocumentOpened](#) ¹⁵³⁰
[OnValidationWindowUpdated](#) ¹⁵³²

This object is a complete ActiveX control and should only be visible if the XMLSpy library is used in the Application Level mode.

CLSID: a258bba2-3835-4c16-8590-72b44f52c471

ProgID: Altova.XMLSpyControl

26.4.7.3.1 Properties

The following properties are defined:

[IntegrationLevel](#) ¹⁵²⁶
[EnableUserPrompts](#) ¹⁵²⁶
[Appearance](#) ¹⁵²⁵
[BorderStyle](#) ¹⁵²⁵

Command related properties:

[CommandsList](#)¹⁵²⁵

[MainMenu](#)¹⁵²⁶

[Toolbars](#)¹⁵²⁷

Access to XMLSpyAPI:

[Application](#)¹⁵²⁵

26.4.7.3.1.1 *Appearance*

Property: Appearance as `short`

Dispatch Id: -520

Description:

A value not equal to 0 displays a client edge around the control. Default value is 0.

26.4.7.3.1.2 *Application*

Property: Application as `Application`

Dispatch Id: 1

Description:

The `Application` property gives access to the `Application` object of the complete XMLSpy automation server API. The property is read-only.

26.4.7.3.1.3 *BorderStyle*

Property: BorderStyle as `short`

Dispatch Id: -504

Description:

A value of 1 displays the control with a thin border. Default value is 0.

26.4.7.3.1.4 *CommandsList*

Property: CommandList as [Commands](#)¹⁵²³ (read-only)

Dispatch Id: 1004

Description:

This property returns a flat list of all commands defined available with XMLSpyControl. To get commands organized according to their menu structure, use [MainMenu](#)¹⁵²⁶. To get toolbar commands, use [Toolbars](#)¹⁵²⁷.

```
public void GetAllXmlSpyCommands()
{
    // Get all commands from the XMLSpy ActiveX control assigned to the current form
    XMLSpyControlLib.XMLSpyCommands commands = this.axXMLSpyControl1.CommandList;
    // Iterate through all commands
    for (int i = 0; i < commands.Count; i++)
    {
        // Get each command by index and output it to the console
        XMLSpyControlLib.XMLSpyCommand cmd = axXMLSpyControl1.CommandList[i];
        Console.WriteLine("{0} {1} {2}", cmd.ID, cmd.Name, cmd.Label.Replace("&", ""));
    }
}
```

C# example

26.4.7.3.1.5 EnableUserPrompts

Property: EnableUserPrompts as `boolean`

Dispatch Id: 1006

Description:

Setting this property to *false*, disables user prompts in the control. The default value is *true*.

26.4.7.3.1.6 IntegrationLevel

Property: IntegrationLevel as [IActiveXIntegrationLevel](#)¹⁵⁴¹

Dispatch Id: 1000

Description:

The `IntegrationLevel` property determines the operation mode of the control. See also [Integration at Application Level](#)¹⁴⁸³ and [Integration at Document Level](#)¹⁴⁸⁵ for more information.

Note: It is important to set this property immediately after the creation of the `XMLSpyControl` object.

26.4.7.3.1.7 MainMenu

Property: MainMenu as [Command](#)¹⁵²¹ (read-only)

Dispatch Id: 1003

Description:

This property provides information about the structure and commands available in the XMLSpyControl main menu, as a `Command` object. The `Command` object contains all available submenus of XMLSpy (for example "File", "Edit", "View" etc.). To access the submenu objects, use the `SubCommands` property of the `MainMenu` property. Each submenu is also a `Command` object. For each submenu, you can then further iterate through their `SubCommands` property in order to get their corresponding child commands and separators (this technique may be used, for example, to create the application menu programmatically). Note that some menu commands act as containers ("parents") for other menu commands, in which case they also have a `SubCommands` property. To get the structure of all menu commands programmatically, you will need a recursive function.

```
public void GetXmlSpyMenus()
{
    // Get the main menu from the XMLSpy ActiveX control assigned to the current form
    XMLSpyControlLib.XMLSpyCommand mainMenu = this.axXMLSpyControl1.MainMenu;

    // Loop through entries of the main menu (e.g. File, Edit, etc.)
    for (int i = 0; i < mainMenu.SubCommands.Count; i++)
    {
        XMLSpyControlLib.XMLSpyCommand menu = mainMenu.SubCommands[i];
        Console.WriteLine("{0} menu has {1} children items (including separators)",
            menu.Label.Replace("&", ""), menu.SubCommands.Count);
    }
}
```

C# example

26.4.7.3.1.8 Toolbars

Property: Toolbars as [Commands](#)¹⁵²³ (read-only)

Dispatch Id: 1005

Description:

This property provides information about the structure of XMLSpyControl toolbars, as a `Command` object. The `Command` object contains all available toolbars of XMLSpy. To access the toolbars, use the `SubCommands` property of the `Toolbars` property. Each toolbar is also a `Command` object. For each toolbar, you can then further iterate through their `SubCommands` property in order to get their commands (this technique may be used, for example, to create the application's toolbars programmatically).

```
public void GetXmlSpyToolbars()
{
    // Get the application toolbars from the StyleVision ActiveX control assigned to the
    // current form
    XMLSpyControlLib.XMLSpyCommands toolbars = this.axXMLSpyControl1.Toolbars;

    // Iterate through all toolbars
    for (int i = 0; i < toolbars.Count; i++)
    {
```

```

XMLSpyControlLib.XMLSpyCommand toolbar = toolbars[i];
Console.WriteLine();
Console.WriteLine("The toolbar \"{0}\" has the following commands:",
toolbar.Label);

// Iterate through all commands of this toolbar
for (int j = 0; j < toolbar.SubCommands.Count; j++)
{
    XMLSpyControlLib.XMLSpyCommand cmd = toolbar.SubCommands[j];
    // Output only command objects that are not separators
    if (!cmd.IsSeparator)
    {
        Console.WriteLine("{0}, {1}, {2}", cmd.ID, cmd.Name, cmd.Label.Replace("&",
""));
    }
}
}
}
}

```

C# example

26.4.7.3.2 Methods

The following methods are defined:

[Open](#)¹⁵²⁸
[Exec](#)¹⁵²⁸
[QueryStatus](#)¹⁵²⁹

26.4.7.3.2.1 Exec

Method: `Exec (nCmdID as long) as boolean`

Dispatch Id: 6

Description:

This method calls the XMLSpy command with the ID `nCmdID`. If the command can be executed, the method returns `true`. To get a list of all available commands, use [CommandsList](#)¹⁵²⁵. To retrieve the status of any command, use [QueryStatus](#)¹⁵²⁹.

26.4.7.3.2.2 Open

Method: `Open (strFilePath as string) as boolean`

Dispatch Id: 5

Description:

The result of the method depends on the extension passed in the argument `strFilePath`. If the file extension is `.sps`, a new document is opened. If the file extension is `.svp`, the corresponding project is opened. If a different file extension is passed into the method, the control tries to load the file as a new component into the active document.

Do not use this method to load documents or projects when using the control in document-level integration mode. Instead, use [XMLSpyControlDocument.Open](#)¹⁵³⁵ and [XMLSpyControlPlaceholder.OpenProject](#)¹⁵⁴⁰.

26.4.7.3.2.3 QueryStatus

Method: `QueryStatus (nCmdID as long) as long`

Dispatch Id: 7

Description:

`QueryStatus` returns the enabled/disabled and checked/unchecked status of the command specified by `nCmdID`. The status is returned as a bit mask.

| Bit | Value | Name | Meaning |
|-----|-------|-----------|--|
| 0 | 1 | Supported | Set if the command is supported. |
| 1 | 2 | Enabled | Set if the command is enabled (can be executed). |
| 2 | 4 | Checked | Set if the command is checked. |

This means that if `QueryStatus` returns 0 the command ID is not recognized as a valid XMLSpy command. If `QueryStatus` returns a value of 1 or 5, the command is disabled.

26.4.7.3.3 Events

The XMLSpyControl ActiveX control provides the following connection point events:

- [OnUpdateCmdUI](#)¹⁵³¹
- [OnOpenedOrFocused](#)¹⁵³¹
- [OnCloseEditingWindow](#)¹⁵²⁹
- [OnFileChangedAlert](#)¹⁵³⁰
- [OnContextChanged](#)¹⁵³⁰
- [OnDocumentOpened](#)¹⁵³⁰
- [OnValidationWindowUpdated](#)¹⁵³²

26.4.7.3.3.1 OnCloseEditingWindow

Event: `OnCloseEditingWindow (i_strFilePath as String) as boolean`

Dispatch Id: 1002

Description:

This event is triggered when XMLSpy needs to close an already open document. As an answer to this event, clients should close the editor window associated with *i_strFilePath*. Returning *true* from this event indicates that the client has closed the document. Clients can return *false* if no specific handling is required and XMLSpyControl should try to close the editor and destroy the associated document control.

26.4.7.3.3.2 OnContextChanged

Event: OnContextChanged (*i_strContextName* as *String*, *i_bActive* as *bool*) as *bool*

Dispatch Id: 1004

Description:

This event is triggered when XMLSpy activates or de-activates one of the following operational contexts:

- XSLT Profiling - "XSLTProfiling" is passed as the context name
- XSLT / XQuery debugging - "DebuggingXSLT" is passed as the context name

26.4.7.3.3.3 OnDocumentOpened

Event: OnDocumentOpened (*objDocument* as *Document*)

Dispatch Id: 1

Description:

This event is triggered whenever a document is opened. The argument *objDocument* is a *Document* object from the XMLSpy automation interface and can be used to query for more details about the document, or perform additional operations. When integrating on document-level, it is often better to use the event [XMLSpyControlDocument.OnDocumentOpened](#)¹⁵³⁷ instead.

26.4.7.3.3.4 OnFileChangedAlert

Event: OnFileChangedAlert (*i_strFilePath* as *String*) as *bool*

Dispatch Id: 1001

Description:

This event is triggered when a file loaded with XMLSpyControl is changed on the hard disk by another application. Clients should return *true*, if they handled the event, or *false*, if XMLSpy should handle it in its customary way, i.e. prompting the user for reload.

26.4.7.3.3.5 *OnLicenseProblem*

Event: OnLicenseProblem (*i_strLicenseProblemText* as *String*)

Dispatch Id: 1005

Description:

This event is triggered when XMLSpyControl detects that no valid license is available for this control. In case of restricted user licenses this can happen some time after the control has been initialized. Integrators should use this event to disable access to this control's functionality. After returning from this event, the control will block access to its functionality (e.g. show empty windows in its controls and return errors on requests).

26.4.7.3.3.6 *OnOpenedOrFocused*

Event: OnOpenedOrFocused (*i_strFilePath* as *String*, *i_bOpenWithThisControl* as *bool*)

Dispatch Id: 1000

Description:

When integrating at application level, this event informs clients that a document has been opened, or made active by XMLSpy.

When integrating at document level, this event instructs the client to open the file *i_strFilePath* in a document window. If the file is already open, the corresponding document window should be made the active window.

If *i_bOpenWithThisControl* is true, the document must be opened with XMLSpyControl, since internal access is required. Otherwise, the file can be opened with different editors.

26.4.7.3.3.7 *OnToolWindowUpdated*

Event: OnToolWindowUpdated (*pToolWnd* as *long*)

Dispatch Id: 1006

Description:

This event is triggered when the tool window is updated.

26.4.7.3.3.8 *OnUpdateCmdUI*

Event: OnUpdateCmdUI ()

Dispatch Id: 1003

Description:

Called frequently to give integrators a good opportunity to check status of XMLSpy commands using [XMLSpyControl.QueryStatus](#)¹⁵²⁹. Do not perform long operations in this callback.

26.4.7.3.3.9 OnValidationWindowUpdated

Event: OnValidationWindowUpdated()

Dispatch Id: 3

Description:

This event is triggered whenever the validation output window is updated with new information.

26.4.7.4 XMLSpyControlDocument

Properties:

[Appearance](#)¹⁵³³
[BorderStyle](#)¹⁵³³
[Document](#)¹⁵³³
[IsModified](#)¹⁵³⁴
[Path](#)¹⁵³⁴
[ReadOnly](#)¹⁵³⁴

Methods:

[Exec](#)¹⁵³⁵
[New](#)¹⁵³⁵
[Open](#)¹⁵³⁵
[QueryStatus](#)¹⁵³⁵
[Reload](#)¹⁵³⁶
[Save](#)¹⁵³⁶
[SaveAs](#)¹⁵³⁶

Events:

[OnDocumentOpened](#)¹⁵³⁷
[OnDocumentClosed](#)¹⁵³⁷
[OnModifiedFlagChanged](#)¹⁵³⁸
[OnContextChanged](#)¹⁵³⁷
[OnFileChangedAlert](#)¹⁵³⁸
[OnActivate](#)¹⁵³⁷

If the XMLSpyControl is integrated in the Document Level mode each document is displayed in an own object of type XMLSpyControlDocument. The XMLSpyControlDocument contains only one document at the time but can be reused to display different files one after another.

This object is a complete ActiveX control.

CLSID: 52A552E6-2AB8-4e3e-B545-BE998233DDA0
ProgID: Altova.XMLSpyControlDocument

26.4.7.4.1 Properties

The following properties are defined:

[ReadOnly](#)¹⁵³⁴
[IsModified](#)¹⁵³⁴
[Path](#)¹⁵³⁴
[Appearance](#)¹⁵³³
[BorderStyle](#)¹⁵³³

Access to XMLSpyAPI:

[Document](#)¹⁵³³

26.4.7.4.1.1 Appearance

Property: Appearance as `short`

Dispatch Id: -520

Description:

A value not equal to 0 displays a client edge around the document control. Default value is 0.

26.4.7.4.1.2 BorderStyle

Property: BorderStyle as `short`

Dispatch Id: -504

Description:

A value of 1 displays the control with a thin border. Default value is 0.

26.4.7.4.1.3 Document

Property: Document as `Document`

Dispatch Id: 1

Description:

The `Document` property gives access to the `Document` object of the XMLSpy automation server API. This interface provides additional functionality which can be used with the document loaded in the control. The property is read-only.

26.4.7.4.1.4 *IsModified*

Property: `IsModified` as `boolean` (read-only)

Dispatch Id: 1006

Description:

`IsModified` is `true` if the document content has changed since the last open, reload or save operation. It is `false`, otherwise.

26.4.7.4.1.5 *Path*

Property: `Path` as `string`

Dispatch Id: 1005

Description:

Sets or gets the full path name of the document loaded into the control.

26.4.7.4.1.6 *ReadOnly*

Property: `ReadOnly` as `boolean`

Dispatch Id: 1007

Description:

Using this property you can turn on and off the read-only mode of the document. If `ReadOnly` is `true` it is not possible to do any modifications.

26.4.7.4.2 *Methods*

The following methods are defined:

Document handling:

[New](#) ¹⁵³⁵

[Open](#) ¹⁵³⁵

[Reload](#) ¹⁵³⁶

[Save](#) ¹⁵³⁶

[SaveAs](#) ¹⁵³⁶

Command Handling:

[Exec](#) ¹⁵³⁵

[QueryStatus](#) ¹⁵³⁵

26.4.7.4.2.1 Exec

Method: Exec (nCmdID as long) as boolean

Dispatch Id: 8

Description:

Exec calls the XMLSpy command with the ID nCmdID. If the command can be executed, the method returns true. This method should be called only if there is currently an active document available in the application.

To get commands organized according to their menu structure, use the [MainMenu](#)¹⁵²⁶ property of XMLSpyControl. To get toolbar commands, use the [Toolbars](#)¹⁵²⁷ property of the XMLSpyControl.

26.4.7.4.2.2 New

Method: New () as boolean

Dispatch Id: 1000

Description:

This method initializes a new document inside the control.

26.4.7.4.2.3 Open

Method: Open (strFileName as string) as boolean

Dispatch Id: 1001

Description:

Open loads the file strFileName as the new document into the control.

26.4.7.4.2.4 QueryStatus

Method: QueryStatus (nCmdID as long) as long

Dispatch Id: 9

Description:

QueryStatus returns the enabled/disabled and checked/unchecked status of the command specified by nCmdID. The status is returned as a bit mask.

| Bit | Value | Name | Meaning |
|-----|-------|-----------|--|
| 0 | 1 | Supported | Set if the command is supported. |
| 1 | 2 | Enabled | Set if the command is enabled (can be executed). |

2 4 Checked Set if the command is checked.

This means that if `QueryStatus` returns 0 the command ID is not recognized as a valid XMLSpy command. If `QueryStatus` returns a value of 1 or 5 the command is disabled. The client should call the `QueryStatus` method of the document control if there is currently an active document available in the application.

26.4.7.4.2.5 Reload

Method: `Reload()` as `boolean`

Dispatch Id: 1002

Description:

`Reload` updates the document content from the file system.

26.4.7.4.2.6 Save

Method: `Save()` as `boolean`

Dispatch Id: 1003

Description:

`Save` saves the current document at the location [Path](#)¹⁵³⁴.

26.4.7.4.2.7 SaveAs

Method: `SaveAs(strFileName as string)` as `boolean`

Dispatch Id: 1004

Description:

`SaveAs` sets [Path](#)¹⁵³⁴ to `strFileName` and then saves the document to this location.

26.4.7.4.3 Events

The XMLSpyControlDocument ActiveX control provides following connection point events:

[OnDocumentOpened](#)¹⁵³⁷
[OnDocumentClosed](#)¹⁵³⁷
[OnModifiedFlagChanged](#)¹⁵³⁸
[OnContextChanged](#)¹⁵³⁷
[OnFileChangedAlert](#)¹⁵³⁸
[OnActivate](#)¹⁵³⁷
[OnSetEditorTitle](#)¹⁵³⁸

26.4.7.4.3.1 *OnActivate*

Event: `OnActivate ()`

Dispatch Id: 1005

Description:

This event is triggered when the document control is activated, has the focus, and is ready for user input.

26.4.7.4.3.2 *OnContextChanged*

Event: `OnContextChanged (i_strContextName as String, i_bActive as bool) as bool`

Dispatch Id: 1004

Description:

This event is triggered when this document is shown in a different XMLSpy view. The following values are passed:

- Grid view - "View_0" is passed as the context name
- Text view - "View_1" is passed as the context name
- Browser view - "View_2" is passed as the context name
- Schema view - "View_3" is passed as the context name
- Authentic view - "View_4" is passed as the context name
- WSDL view - "View_5" is passed as the context name

26.4.7.4.3.3 *OnDocumentClosed*

Event: `OnDocumentClosed (objDocument as Document)`

Dispatch Id: 1001

Description:

This event is triggered whenever the document loaded into this control is closed. The argument `objDocument` is a `Document` object from the XMLSpy automation interface and should be used with care.

26.4.7.4.3.4 *OnDocumentOpened*

Event: `OnDocumentOpened (objDocument as Document)`

Dispatch Id: 1000

Description:

This event is triggered whenever a document is opened in this control. The argument `objDocument` is a `Document` object from the XMLSpy automation interface, and can be used to query for more details about the document, or perform additional operations.

26.4.7.4.3.5 *OnDocumentSaveAs*

Event: `OnContextDocumentSaveAs (i_strFileName as String)`

Dispatch Id: 1007

Description:

This event is triggered when this document gets internally saved under a new name.

26.4.7.4.3.6 *OnFileChangedAlert*

Event: `OnFileChangedAlert () as bool`

Dispatch Id: 1003

Description:

This event is triggered when the file loaded into this document control is changed on the hard disk by another application. Clients should return `true`, if they handled the event, or `false`, if XMLSpy should handle it in its customary way, i.e. prompting the user for reload.

26.4.7.4.3.7 *OnModifiedFlagChanged*

Event: `OnModifiedFlagChanged (i_bIsModified as boolean)`

Dispatch Id: 1002

Description:

This event gets triggered whenever the document changes between modified and unmodified state. The parameter `i_bIsModified` is `true` if the document contents differs from the original content, and `false`, otherwise.

26.4.7.4.3.8 *OnSetEditorTitle*

Event: `OnSetEditorTitle ()`

Dispatch Id: 1006

Description:

This event is being raised when the contained document is being internally renamed.

26.4.7.5 XMLSpyControlPlaceholder

Properties available for all kinds of placeholder windows:

[PlaceholderWindowID](#)¹⁵³⁹

Properties for project placeholder window:

[Project](#)¹⁵⁴⁰

Methods for project placeholder window:

[OpenProject](#)¹⁵⁴⁰

[CloseProject](#)¹⁵⁴⁰

The `XMLSpyControlPlaceholder` control is used to show the additional XMLSpy windows like Overview, Library or Project window. It is used like any other ActiveX control and can be placed anywhere in the client application.

CLSID: 135DEEF4-6DF0-47c2-8F8C-F145F5F3F672

ProgID: Altova.XMLSpyControlPlaceholder

26.4.7.5.1 Properties

The following properties are defined:

[PlaceholderWindowID](#)¹⁵³⁹

Access to XMLSpyAPI:

[Project](#)¹⁵⁴⁰

26.4.7.5.1.1 Label

Property: Label as `String` (read-only)

Dispatch Id: 1001

Description:

This property gives access to the title of the placeholder. The property is read-only.

26.4.7.5.1.2 PlaceholderWindowID

Property: PlaceholderWindowID as [XMLSpyControlPlaceholderWindow](#)¹⁵⁴²

Dispatch Id: 1

Description:

This property specifies which XMLSpy window should be displayed in the client area of the control. The `PlaceholderWindowID` can be set at any time to any valid value of the [XMLSpyControlPlaceholderWindow](#)¹⁵⁴² enumeration. The control changes its state immediately and shows the new XMLSpy window.

26.4.7.5.1.3 Project

Property: `Project` as `Project` (read-only)

Dispatch Id: 2

Description:

The `Project` property gives access to the `Project` object of the XMLSpy automation server API. This interface provides additional functionality which can be used with the project loaded into the control. The property will return a valid project interface only if the placeholder window has [PlaceholderWindowID](#)¹⁵³⁹ with a value of `XMLSpyXProjectWindow (=3)`. The property is read-only.

26.4.7.5.2 Methods

The following method is defined:

[OpenProject](#)¹⁵⁴⁰

[CloseProject](#)¹⁵⁴⁰

26.4.7.5.2.1 OpenProject

Method: `OpenProject (strFileName as string) as boolean`

Dispatch Id: 3

Description:

`OpenProject` loads the file `strFileName` as the new project into the control. The method will fail if the placeholder window has a [PlaceholderWindowID](#)¹⁵³⁹ different to `XMLSpyXProjectWindow (=3)`.

26.4.7.5.2.2 CloseProject

Method: `CloseProject ()`

Dispatch Id: 4

Description:

`CloseProject` closes the project loaded by the control. The method will fail if the placeholder window has a [PlaceholderWindowID](#)¹⁵³⁹ different to `XMLSpyXProjectWindow (=3)`.

26.4.7.5.3 Events

The XMLSpyControlPlaceholder ActiveX control provides following connection point events:

[OnModifiedFlagChanged](#)¹⁵⁴¹

26.4.7.5.3.1 OnModifiedFlagChanged

Event: OnModifiedFlagChanged (i_bIsModified as boolean)

Dispatch Id: 1

Description:

This event gets triggered only for placeholder controls with a [PlaceholderWindowID](#)¹⁵³⁹ of XMLSpyXProjectWindow (=3). The event is fired whenever the project content changes between modified and unmodified state. The parameter *i_bIsModified* is *true* if the project contents differs from the original content, and *false*, otherwise.

26.4.7.5.3.2 OnSetLabel

Event: OnSetLabel (i_strNewLabel as string)

Dispatch Id: 1000

Description:

Raised when the title of the placeholder window is changed.

26.4.7.6 Enumerations

The following enumerations are defined:

[ICActiveXIntegrationLevel](#)¹⁵⁴¹

[XMLSpyControlPlaceholderWindow](#)¹⁵⁴²

26.4.7.6.1 ICActiveXIntegrationLevel

Possible values for the [IntegrationLevel](#)¹⁵²⁶ property of the XMLSpyControl.

ICActiveXIntegrationOnApplicationLevel = 0

ICActiveXIntegrationOnDocumentLevel = 1

26.4.7.6.2 XMLSpyControlPlaceholderWindow

This enumeration contains the list of the supported additional XMLSpy windows.

```
XMLSpyControlNoToolWnd = -1
XMLSpyControlEntryHelperTopToolWnd = 0
XMLSpyControlEntryHelperMiddleToolWnd = 1
XMLSpyControlEntryHelperBottomToolWnd = 2
XMLSpyControlValidatorOutputToolWnd = 3
XMLSpyControlProjectWindowToolWnd = 4
XMLSpyControlXSLTDebuggerContextToolWnd = 5
XMLSpyControlXSLTDebuggerCallstackToolWnd = 6
XMLSpyControlXSLTDebuggerVariableToolWnd = 7
XMLSpyControlXSLTDebuggerWatchToolWnd = 8
XMLSpyControlXSLTDebuggerTemplateToolWnd = 9
XMLSpyControlXSLTDebuggerInfoToolWnd = 10
XMLSpyControlXSLTDebuggerMessageToolWnd = 11
XMLSpyControlXSLTDebuggerTraceToolWnd = 12
XMLSpyControlSOAPDebuggerToolWnd = 13
XMLSpyControlXPathProfilerListToolWnd = 14
XMLSpyControlXPathProfilerTreeToolWnd = 15
XMLSpyControlXPathDialogToolWnd = 16
XMLSpyControlDBQueryManagerToolWnd = 17
XMLSpyControlInfoToolWnd = 18
XMLSpyControlXSLOutlineToolWnd = 19
XMLSpyControlSchemaFindToolWnd = 20
XMLSpyControlXBRLFindToolWnd = 21
XMLSpyControlChartsToolWnd = 22
```

27 Appendices

These appendices contain technical information about XMLSpy and important licensing information. Each appendix contains sub-sections as given below:

[Engine Information](#)¹⁵⁴⁴

- [XSLT and XQuery Engine Information](#)¹⁵⁴⁴
- [XSLT and XQuery Extension Functions](#)¹⁵⁵²

[Datatype Conversions between DBs and XML Schemas](#)¹⁶⁴⁷

- [DBs to XML Schemas](#)¹⁶⁴⁷
- [XML Schemas to DBs](#)¹⁶⁵³

[Technical Data](#)¹⁶⁶¹

- [OS and memory requirements](#)¹⁶⁶¹
- [Altova XSLT and XQuery Engines](#)¹⁶⁶¹
- [Unicode support](#)¹⁶⁶²
- [Internet usage](#)¹⁶⁶²

[License Information](#)¹⁶⁶³

- [Electronic software distribution](#)¹⁶⁶³
- [Software activation and license metering](#)¹⁶⁶⁴
- [End User License Agreement](#)¹⁶⁶⁵

27.1 XSLT and XQuery Engine Information

The XSLT and XQuery engines of XMLSpy follow the W3C specifications closely and are therefore stricter than previous Altova engines—such as those in previous versions of XMLSpy. As a result, minor errors that were ignored by previous engines are now flagged as errors by XMLSpy.

For example:

- It is a type error (`err:XPTY0018`) if the result of a path operator contains both nodes and non-nodes.
- It is a type error (`err:XPTY0019`) if `E1` in a path expression `E1/E2` does not evaluate to a sequence of nodes.

If you encounter this kind of error, modify either the XSLT/XQuery document or the instance document as appropriate.

This section describes implementation-specific features of the engines, organized by specification:

- [XSLT 1.0](#)¹⁵⁴⁴
- [XSLT 2.0](#)¹⁵⁴⁴
- [XSLT 3.0](#)¹⁵⁴⁶
- [XQuery 1.0](#)¹⁵⁴⁷
- [XQuery 3.1](#)¹⁵⁵⁰

27.1.1 XSLT 1.0

The XSLT 1.0 Engine of XMLSpy conforms to the World Wide Web Consortium's (W3C's) [XSLT 1.0 Recommendation of 16 November 1999](#) and [XPath 1.0 Recommendation of 16 November 1999](#). Note the following information about the implementation.

Notes about the implementation

When the `method` attribute of `xsl:output` is set to HTML, or if HTML output is selected by default, then special characters in the XML or XSLT file are inserted in the HTML document as HTML character references in the output. For instance, the character U+00A0 (the hexadecimal character reference for a non-breaking space) is inserted in the HTML code either as a character reference (` ` or ` `) or as an entity reference, ` `.

27.1.2 XSLT 2.0

This section:

- [Engine conformance](#)¹⁵⁴⁵
- [Backward compatibility](#)¹⁵⁴⁵
- [Namespaces](#)¹⁵⁴⁵
- [Schema awareness](#)¹⁵⁴⁵
- [Implementation-specific behavior](#)¹⁵⁴⁶

Conformance

The XSLT 2.0 engine of XMLSpy conforms to the World Wide Web Consortium's (W3C's) [XSLT 2.0 Recommendation of 23 January 2007](#) and [XPath 2.0 Recommendation of 14 December 2010](#).

Backwards Compatibility

The XSLT 2.0 engine is backwards compatible. Typically, the backwards compatibility of the XSLT 2.0 engine comes into play when using the XSLT 2.0 engine to process an XSLT 1.0 stylesheet or instruction. Note that there could be differences in the outputs produced by the XSLT 1.0 Engine and the backwards-compatible XSLT 2.0 engine.

Namespaces

Your XSLT 2.0 stylesheet should declare the following namespaces in order for you to be able to use the type constructors and functions available in XSLT 2.0. The prefixes given below are conventionally used; you could use alternative prefixes if you wish.

| Namespace Name | Prefix | Namespace URI |
|---------------------|--------|---|
| XML Schema types | xs: | http://www.w3.org/2001/XMLSchema |
| XPath 2.0 functions | fn: | http://www.w3.org/2005/xpath-functions |

Typically, these namespaces will be declared on the `xsl:stylesheet` or `xsl:transform` element, as shown in the following listing:

```
<xsl:stylesheet version="2.0"
  xmlns:xsl="http://www.w3.org/1999/XSL/Transform"
  xmlns:xs="http://www.w3.org/2001/XMLSchema"
  xmlns:fn="http://www.w3.org/2005/xpath-functions"
  ...
/>
```

The following points should be noted:

- The XSLT 2.0 engine uses the XPath 2.0 and XQuery 1.0 Functions namespace (listed in the table above) as its **default functions namespace**. So you can use XPath 2.0 and XSLT 2.0 functions in your stylesheet without any prefix. If you declare the XPath 2.0 Functions namespace in your stylesheet with a prefix, then you can additionally use the prefix assigned in the declaration.
- When using type constructors and types from the XML Schema namespace, the prefix used in the namespace declaration must be used when calling the type constructor (for example, `xs:date`).
- Some XPath 2.0 functions have the same name as XML Schema datatypes. For example, for the XPath functions `fn:string` and `fn:boolean` there exist XML Schema datatypes with the same local names: `xs:string` and `xs:boolean`. So if you were to use the XPath expression `string('Hello')`, the expression evaluates as `fn:string('Hello')`—not as `xs:string('Hello')`.

Schema-awareness

The XSLT 2.0 engine is schema-aware. So you can use user-defined schema types and the `xsl:validate` instruction.

Implementation-specific behavior

Given below is a description of how the XSLT 2.0 engine handles implementation-specific aspects of certain XSLT 2.0 functions.

xsl:result-document

Additionally supported encodings are (the Altova-specific): `x-base16tobinary` and `x-base64tobinary`.

function-available

The function tests for the availability of in-scope functions (XSLT, XPath, and extension functions).

unparsed-text

The `href` argument accepts (i) relative paths for files in the base-uri folder, and (ii) absolute paths with or without the `file://` protocol. Additionally supported encodings are (the Altova-specific): `x-binarytobase16` and `x-binarytobase64`. Example: `xs:base64Binary(unparsed-text('chart.png', 'x-binarytobase64'))`.

unparsed-text-available

The `href` argument accepts (i) relative paths for files in the base-uri folder, and (ii) absolute paths with or without the `file://` protocol. Additionally supported encodings are (the Altova-specific): `x-binarytobase16` and `x-binarytobase64`.

Note: The following encoding values, which were implemented in earlier versions of RaptorXML's predecessor product, AltovaXML, are now deprecated: `base16tobinary`, `base64tobinary`, `binarytobase16` and `binarytobase64`.

27.1.3 XSLT 3.0

The XSLT 3.0 Engine of XMLSpy conforms to the World Wide Web Consortium's (W3C's) [XSLT 3.0 Recommendation of 8 June 2017](#) and [XPath 3.1 Recommendation of 21 March 2017](#).

The XSLT 3.0 engine has the [same implementation-specific characteristics as the XSLT 2.0 engine](#)¹⁵⁴⁴. Additionally, it includes support for a number of new XSLT 3.0 features: XPath/XQuery 3.1 functions and operators, and the [XPath 3.1 specification](#).

Note: The optional [streaming feature](#) is not supported currently. The entire document will be loaded into memory regardless of the value of the `streamable` attribute. If enough memory is available, then: (i) the entire document will be processed—without streaming, (ii) [guaranteed-streamable constructs](#) will be processed correctly, as if the execution used streaming, and (iii) streaming errors will not be detected. In 64-bit apps, non-streaming execution should not be a problem. If memory does turn out to be an issue, a solution would be to add more memory to the system.

Namespaces

Your XSLT 3.0 stylesheet should declare the following namespaces in order for you to be able to use all the type constructors and functions available in XSLT 3.0. The prefixes given below are conventionally used; you could use alternative prefixes if you wish.

| Namespace Name | Prefix | Namespace URI |
|----------------|--------|---------------|
|----------------|--------|---------------|

| | | |
|-------------------------------------|--------|---|
| XML Schema types | xs: | http://www.w3.org/2001/XMLSchema |
| XPath/XQuery 3.1 functions | fn: | http://www.w3.org/2005/xpath-functions |
| Math functions | math: | http://www.w3.org/2005/xpath-functions/math |
| Map functions | map: | http://www.w3.org/2005/xpath-functions/map |
| Array functions | array: | http://www.w3.org/2005/xpath-functions/array |
| XQuery, XSLT, and XPath Error Codes | err: | http://www.w3.org/2005/xpath-functions/xqt-errors |
| Serialization functions | output | http://www.w3.org/2010/xslt-xquery-serialization |

Typically, these namespaces will be declared on the `xsl:stylesheet` or `xsl:transform` element, as shown in the following listing:

```
<xsl:stylesheet version="3.0"
  xmlns:xsl="http://www.w3.org/1999/XSL/Transform"
  xmlns:xs="http://www.w3.org/2001/XMLSchema"
  xmlns:fn="http://www.w3.org/2005/xpath-functions"
  ...
</xsl:stylesheet>
```

The following points should be noted:

- The XSLT 3.0 engine uses the XPath and XQuery Functions and Operators 3.1 namespace (listed in the table above) as its **default functions namespace**. So you can use the functions of this namespace in your stylesheet without any prefix. If you declare the Functions namespace in your stylesheet with a prefix, then you can additionally use the prefix assigned in the declaration.
- When using type constructors and types from the XML Schema namespace, the prefix used in the namespace declaration must be used when calling the type constructor (for example, `xs:date`).
- Some XPath/XQuery functions have the same name as XML Schema datatypes. For example, for the XPath functions `fn:string` and `fn:boolean` there exist XML Schema datatypes with the same local names: `xs:string` and `xs:boolean`. So if you were to use the XPath expression `string('Hello')`, the expression evaluates as `fn:string('Hello')`—not as `xs:string('Hello')`.

27.1.4 XQuery 1.0

This section:

- [Engine conformance](#) ¹⁵⁴⁸
- [Schema awareness](#) ¹⁵⁴⁸
- [Encoding](#) ¹⁵⁴⁸
- [Namespaces](#) ¹⁵⁴⁵
- [XML source and validation](#) ¹⁵⁴⁹
- [Static and dynamic type checking](#) ¹⁵⁴⁹
- [Library modules](#) ¹⁵⁴⁹
- [External functions](#) ¹⁵⁴⁹

- [Collations](#) ¹⁵⁴⁹
- [Precision of numeric data](#) ¹⁵⁵⁰
- [XQuery instructions support](#) ¹⁵⁵⁰
- [Implementation-specific behavior](#) ¹⁵⁵⁰

Conformance

The XQuery 1.0 Engine of XMLSpy conforms to the World Wide Web Consortium's (W3C's) [XQuery 1.0 Recommendation of 14 December 2010](#). The XQuery standard gives implementations discretion about how to implement many features. Given below is a list explaining how the XQuery 1.0 Engine implements these features.

Schema awareness

The XQuery 1.0 Engine is **schema-aware**.

Encoding

The UTF-8 and UTF-16 character encodings are supported.

Namespaces

The following namespace URIs and their associated bindings are pre-defined.

| Namespace Name | Prefix | Namespace URI |
|--------------------|--------|---|
| XML Schema types | xs: | http://www.w3.org/2001/XMLSchema |
| Schema instance | xsi: | http://www.w3.org/2001/XMLSchema-instance |
| Built-in functions | fn: | http://www.w3.org/2005/xpath-functions |
| Local functions | local: | http://www.w3.org/2005/xquery-local-functions |

The following points should be noted:

- The XQuery 1.0 Engine recognizes the prefixes listed above as being bound to the corresponding namespaces.
- Since the built-in functions namespace listed above (see `fn:`) is the default functions namespace in XQuery, the `fn:` prefix does not need to be used when built-in functions are invoked (for example, `string("Hello")` will call the `fn:string` function). However, the prefix `fn:` can be used to call a built-in function without having to declare the namespace in the query prolog (for example: `fn:string("Hello")`).
- You can change the default functions namespace by declaring the `default function namespace` expression in the query prolog.
- When using types from the XML Schema namespace, the prefix `xs:` may be used without having to explicitly declare the namespaces and bind these prefixes to them in the query prolog. (Example: `xs:date` and `xs:yearMonthDuration`.) If you wish to use some other prefix for the XML Schema namespace, this must be explicitly declared in the query prolog. (Example: `declare namespace alt = "http://www.w3.org/2001/XMLSchema"; alt:date("2004-10-04")`.)
- Note that the `untypedAtomic`, `dayTimeDuration`, and `yearMonthDuration` datatypes have been moved, with the CRs of 23 January 2007, from the XPath Datatypes namespace to the XML Schema namespace, so: `xs:yearMonthDuration`.

If namespaces for functions, type constructors, node tests, etc are wrongly assigned, an error is reported. Note, however, that some functions have the same name as schema datatypes, e.g. `fn:string` and `fn:boolean`. (Both `xs:string` and `xs:boolean` are defined.) The namespace prefix determines whether the function or type constructor is used.

XML source document and validation

XML documents used in executing an XQuery document with the XQuery 1.0 Engine must be well-formed. However, they do not need to be valid according to an XML Schema. If the file is not valid, the invalid file is loaded without schema information. If the XML file is associated with an external schema and is valid according to it, then post-schema validation information is generated for the XML data and will be used for query evaluation.

Static and dynamic type checking

The static analysis phase checks aspects of the query such as syntax, whether external references (e.g. for modules) exist, whether invoked functions and variables are defined, and so on. If an error is detected in the static analysis phase, it is reported and the execution is stopped.

Dynamic type checking is carried out at run-time, when the query is actually executed. If a type is incompatible with the requirement of an operation, an error is reported. For example, the expression `xs:string("1") + 1` returns an error because the addition operation cannot be carried out on an operand of type `xs:string`.

Library Modules

Library modules store functions and variables so they can be reused. The XQuery 1.0 Engine supports modules that are stored in **a single external XQuery file**. Such a module file must contain a `module` declaration in its prolog, which associates a target namespace. Here is an example module:

```
module namespace libns="urn:module-library";
declare variable $libns:company := "Altova";
declare function libns:webaddress() { "http://www.altova.com" };
```

All functions and variables declared in the module belong to the namespace associated with the module. The module is used by importing it into an XQuery file with the `import module` statement in the query prolog. The `import module` statement only imports functions and variables declared directly in the library module file. As follows:

```
import module namespace modlib = "urn:module-library" at "modulefilename.xq";
if      ($modlib:company = "Altova")
then    modlib:webaddress()
else    error("No match found.")
```

External functions

External functions are not supported, i.e. in those expressions using the `external` keyword, as in:

```
declare function hoo($param as xs:integer) as xs:string external;
```

Collations

The default collation is the Unicode-codepoint collation, which compares strings on the basis of their Unicode codepoint. Other supported collations are the [ICU collations](#) listed [here](#)⁴⁵⁵². To use a specific collation, supply

its URI as given in the [list of supported collations](#)¹⁵⁵². Any string comparisons, including for the `fn:max` and `fn:min` functions, will be made according to the specified collation. If the collation option is not specified, the default Unicode-codepoint collation is used.

Precision of numeric types

- The `xs:integer` datatype is arbitrary-precision, i.e. it can represent any number of digits.
- The `xs:decimal` datatype has a limit of 20 digits after the decimal point.
- The `xs:float` and `xs:double` datatypes have limited-precision of 15 digits.

XQuery Instructions Support

The `Pragma` instruction is not supported. If encountered, it is ignored and the fallback expression is evaluated.

Implementation-specific behavior

Given below is a description of how the XQuery and XQuery Update 1.0 engines handle implementation-specific aspects of certain functions.

unparsed-text

The `href` argument accepts (i) relative paths for files in the base-uri folder, and (ii) absolute paths with or without the `file://` protocol. Additionally supported encodings are (the Altova-specific): `x-binarytobase16` and `x-binarytobase64`. Example: `xs:base64Binary(unparsed-text('chart.png', 'x-binarytobase64'))`.

unparsed-text-available

The `href` argument accepts (i) relative paths for files in the base-uri folder, and (ii) absolute paths with or without the `file://` protocol. Additionally supported encodings are (the Altova-specific): `x-binarytobase16` and `x-binarytobase64`.

Note: The following encoding values, which were implemented in earlier versions of RaptorXML's predecessor product, AltovaXML, are now deprecated: `base16tobinary`, `base64tobinary`, `binarytobase16` and `binarytobase64`.

27.1.5 XQuery 3.1

The XQuery 3.1 Engine of XMLSpy conforms to the World Wide Web Consortium's (W3C's) [XQuery 3.1 Recommendation of 21 March 2017](#) and includes support for XPath and XQuery Functions 3.1. The XQuery 3.1 specification is a superset of the 3.0 specification. The XQuery 3.1 engine therefore supports XQuery 3.0 features.

Namespaces

Your XQuery 3.1 document should declare the following namespaces in order for you to be able to use all the type constructors and functions available in XQuery 3.1. The prefixes given below are conventionally used; you could use alternative prefixes if you wish.

| Namespace Name | Prefix | Namespace URI |
|----------------|--------|---------------|
|----------------|--------|---------------|

| | | |
|-------------------------------------|---------------------|--|
| XML Schema types | <code>xs:</code> | <code>http://www.w3.org/2001/XMLSchema</code> |
| XPath/XQuery 3.1 functions | <code>fn:</code> | <code>http://www.w3.org/2005/xpath-functions</code> |
| Math functions | <code>math:</code> | <code>http://www.w3.org/2005/xpath-functions/math</code> |
| Map functions | <code>map:</code> | <code>http://www.w3.org/2005/xpath-functions/map</code> |
| Array functions | <code>array:</code> | <code>http://www.w3.org/2005/xpath-functions/array</code> |
| XQuery, XSLT, and XPath Error Codes | <code>err:</code> | <code>http://www.w3.org/2005/xpath-functions/xqt-errors</code> |
| Serialization functions | <code>output</code> | <code>http://www.w3.org/2010/xslt-xquery-serialization</code> |

The following points should be noted:

- The XQuery 3.1 Engine recognizes the prefixes listed above as being bound to the corresponding namespaces.
- Since the built-in functions namespace listed above (see `fn:`) is the default functions namespace in XQuery, the `fn:` prefix does not need to be used when built-in functions are invoked (for example, `string("Hello")` will call the `fn:string` function). However, the prefix `fn:` can be used to call a built-in function without having to declare the namespace in the query prolog (for example: `fn:string("Hello")`).
- You can change the default functions namespace by declaring the `default function namespace` expression in the query prolog.
- When using types from the XML Schema namespace, the prefix `xs:` may be used without having to explicitly declare the namespaces and bind these prefixes to them in the query prolog. (Example: `xs:date` and `xs:yearMonthDuration`.) If you wish to use some other prefix for the XML Schema namespace, this must be explicitly declared in the query prolog. (Example: `declare namespace alt = "http://www.w3.org/2001/XMLSchema"; alt:date("2004-10-04")`.)

If namespaces for functions, type constructors, node tests, etc are wrongly assigned, an error is reported. Note, however, that some functions have the same name as schema datatypes, e.g. `fn:string` and `fn:boolean`. (Both `xs:string` and `xs:boolean` are defined.) The namespace prefix determines whether the function or type constructor is used.

Implementation-specific behavior

Implementation-specific characteristics are the same as for [XQuery 1.0](#)⁽¹⁵⁴⁷⁾.

Additionally, the Altova-specific encoding `x-base64tobinary` can be used to create a binary result document, such as an image.

27.2 XSLT and XPath/XQuery Functions

This section lists Altova extension functions and other extension functions that can be used in XPath and/or XQuery expressions. Altova extension functions can be used with Altova's XSLT and XQuery engines, and provide functionality additional to that available in the function libraries defined in the W3C standards.

This section mainly describes XPath/XQuery extension functions that have been created by Altova to provide additional operations. [These functions](#)¹⁵⁵³ can be computed by Altova's XSLT and XQuery engines according to the rules described in this section. For information about the regular XPath/XQuery functions, see [Altova's XPath/XQuery Function Reference](#).

General points

The following general points should be noted:

- Functions from the core function libraries defined in the W3C specifications can be called without a prefix. That's because the Altova XSLT and XQuery engines read non-prefixed functions as belonging to the namespace <http://www.w3.org/2005/xpath-functions>, which is the default functions namespace specified in the XPath/XQuery functions specifications. If this namespace is explicitly declared in an XSLT or XQuery document, the prefix used in the namespace declaration can also optionally be used on function names.
- In general, if a function expects a sequence of one item as an argument, and a sequence of more than one item is submitted, then an error is returned.
- All string comparisons are done using the Unicode codepoint collation.
- Results that are QNames are serialized in the form `[prefix:]localname`.

Precision of xs:decimal

The precision refers to the number of digits in the number, and a minimum of 18 digits is required by the specification. For division operations that produce a result of type `xs:decimal`, the precision is 19 digits after the decimal point with no rounding.

Implicit timezone

When two `date`, `time`, or `dateTime` values need to be compared, the timezones of the values being compared need to be known. When the timezone is not explicitly given in such a value, the implicit timezone is used. The implicit timezone is taken from the system clock, and its value can be checked with the `implicit-timezone()` function.

Collations

The default collation is the Unicode codepoint collation, which compares strings on the basis of their Unicode codepoint. The engine uses the Unicode Collation Algorithm. Other supported collations are the [ICU collations](#) listed below; to use one of these, supply its URI as given in the table below. Any string comparisons, including for the `max` and `min` functions, will be made according to the specified collation. If the collation option is not specified, the default Unicode-codepoint collation is used.

| Language | URIs |
|------------|-------|
| da: Danish | da_DK |

| | |
|----------------------|---|
| de: German | de_AT, de_BE, de_CH, de_DE, de_LI, de_LU |
| en: English | en_AS, en_AU, en_BB, en_BE, en_BM, en_BW, en_BZ, en_CA, en_GB, en_GU, en_HK, en_IE, en_IN, en_JM, en_MH, en_MP, en_MT, en_MU, en_NA, en_NZ, en_PH, en_PK, en_SG, en_TT, en_UM, en_US, en_VI, en_ZA, en_ZW |
| es: Spanish | es_419, es_AR, es_BO, es_CL, es_CO, es_CR, es_DO, es_EC, es_ES, es_GQ, es_GT, es_HN, es_MX, es_NI, es_PA, es_PE, es_PR, es_PY, es_SV, es_US, es_UY, es_VE |
| fr: French | fr_BE, fr_BF, fr_BI, fr_BJ, fr_BL, fr_CA, fr_CD, fr_CF, fr_CG, fr_CH, fr_CI, fr_CM, fr_DJ, fr_FR, fr_GA, fr_GN, fr_GP, fr_GQ, fr_KM, fr_LU, fr_MC, fr_MF, fr_MG, fr_ML, fr_MQ, fr_NE, fr_RE, fr_RW, fr_SN, fr_TD, fr_TG |
| it: Italian | it_CH, it_IT |
| ja: Japanese | ja_JP |
| nb: Norwegian Bokmal | nb_NO |
| nl: Dutch | nl_AW, nl_BE, nl_NL |
| nn: Nynorsk | nn_NO |
| pt: Portuguese | pt_AO, pt_BR, pt_GW, pt_MZ, pt_PT, pt_ST |
| ru: Russian | ru_MD, ru_RU, ru_UA |
| sv: Swedish | sv_FI, sv_SE |

Namespace axis

The namespace axis is deprecated in XPath 2.0. Use of the namespace axis is, however, supported. To access namespace information with XPath 2.0 mechanisms, use the `in-scope-prefixes()`, `namespace-uri()` and `namespace-uri-for-prefix()` functions.

27.2.1 Altova Extension Functions

Altova extension functions can be used in XPath/XQuery expressions. They provide additional functionality to the functionality that is available in the standard library of XPath, XQuery, and XSLT functions. Altova extension functions are in the **Altova extension functions namespace**, <http://www.altova.com/xslt-extensions>, and are indicated in this section with the prefix `altova:`, which is assumed to be bound to this namespace. Note that, in future versions of your product, support for a function might be discontinued or the behavior of individual functions might change. Consult the documentation of future releases for information about support for Altova extension functions in that release.

Functions defined in the W3C's XPath/XQuery Functions specifications can be used in: (i) XPath expressions in an XSLT context, and (ii) in XQuery expressions in an XQuery document. In this documentation we indicate the functions that can be used in the former context (XPath in XSLT) with an **XP** symbol and call them XPath functions; those functions that can be used in the latter (XQuery) context are indicated with an **XQ** symbol; they work as XQuery functions. The W3C's XSLT specifications—not XPath/XQuery Functions specifications—also

define functions that can be used in XPath expressions in XSLT documents. These functions are marked with an **XSLT** symbol and are called XSLT functions. The XPath/XQuery and XSLT versions in which a function can be used are indicated in the description of the function (see *symbols below*). Functions from the XPath/XQuery and XSLT function libraries are listed without a prefix. Extension functions from other libraries, such as Altova extension functions, are listed with a prefix.

| | |
|---|--|
| <i>XPath functions (used in XPath expressions in XSLT):</i> | XP1 XP2 XP3.1 |
| <i>XSLT functions (used in XPath expressions in XSLT):</i> | XSLT1 XSLT2 XSLT3 |
| <i>XQuery functions (used in XQuery expressions in XQuery):</i> | XQ1 XQ3.1 |

Usage of Altova extension functions

In order to use Altova extension functions, you must declare the Altova extension functions namespace (*first highlight in code listing below*) and then use the extension functions so that they are resolved as belonging to this namespace (see *second highlight*). The example below uses the Altova extension function named **age**.

```
<xsl:stylesheet version="2.0"
  xmlns:xsl="http://www.w3.org/1999/XSL/Transform"
  xmlns:xs="http://www.w3.org/2001/XMLSchema"
  xmlns:fn="http://www.w3.org/2005/xpath-functions"
  xmlns:altova="http://www.altova.com/xslt-extensions">
  <xsl:output method="text" encoding="ISO-8859-1"/>
  <xsl:template match="Persons">
    <xsl:for-each select="Person">
      <xsl:value-of select="concat(Name, ': ')" />
      <xsl:value-of select="altova:age(xs:date(BirthDate))" />
      <xsl:value-of select="' years&#x0A;'" />
    </xsl:for-each>
  </xsl:template>
</xsl:stylesheet>
```

XSLT functions ¹⁵⁵⁵

XSLT functions can only be used in XPath expressions in an XSLT context (similarly to XSLT 2.0's `current-group()` or `key()` functions). These functions are not intended for, and will not work in, a non-XSLT context (for instance, in an XQuery context). Note that XSLT functions for XBRL can be used only with editions of Altova products that have XBRL support.

XPath/XQuery functions

XPath/XQuery functions can be used both in XPath expressions in XSLT contexts as well as in XQuery expressions:

- [Date/Time](#) ¹⁵⁵⁷
- [Geolocation](#) ¹⁵⁷⁴
- [Image-related](#) ¹⁵⁸⁶
- [Numeric](#) ¹⁵⁹⁰
- [Sequence](#) ¹⁶¹²
- [String](#) ¹⁶²⁰

- [Miscellaneous](#) ¹⁶²⁶

27.2.1.1 XSLT Functions

XSLT extension functions can be used in XPath expressions in an XSLT context. They will not work in a non-XSLT context (for instance, in an XQuery context).

Note about naming of functions and language applicability

Altova extension functions can be used in XPath/XQuery expressions. They provide additional functionality to the functionality that is available in the standard library of XPath, XQuery, and XSLT functions. Altova extension functions are in the **Altova extension functions namespace**, <http://www.altova.com/xslt-extensions>, and are indicated in this section with the prefix **altova:**, which is assumed to be bound to this namespace. Note that, in future versions of your product, support for a function might be discontinued or the behavior of individual functions might change. Consult the documentation of future releases for information about support for Altova extension functions in that release.

| | |
|---|--|
| <i>XPath functions (used in XPath expressions in XSLT):</i> | XP1 XP2 XP3.1 |
| <i>XSLT functions (used in XPath expressions in XSLT):</i> | XSLT1 XSLT2 XSLT3 |
| <i>XQuery functions (used in XQuery expressions in XQuery):</i> | XQ1 XQ3.1 |

General functions

▼ distinct-nodes [altova:]

altova:distinct-nodes(*node()* *) **as node()** * **XSLT1** **XSLT2** **XSLT3**

Takes a set of one or more nodes as its input and returns the same set minus nodes with duplicate values. The comparison is done using the XPath/XQuery function `fn:deep-equal`.

☐ Examples

- **altova:distinct-nodes**(`country`) returns all child `country` nodes less those having duplicate values.

▼ evaluate [altova:]

altova:evaluate(*XPathExpression as xs:string*[, *ValueOf\$p1*, ... *ValueOf\$pN*]) **XSLT1** **XSLT2** **XSLT3**

Takes an XPath expression, passed as a string, as its mandatory argument. It returns the output of the evaluated expression. For example: **altova:evaluate**('//Name[1]') returns the contents of the first `Name` element in the document. Note that the expression `//Name[1]` is passed as a string by enclosing it in single quotes.

The `altova:evaluate` function can optionally take additional arguments. These arguments are the values of in-scope variables that have the names `p1`, `p2`, `p3`... `pN`. Note the following points about usage: (i) The variables must be defined with names of the form `pX`, where `X` is an integer; (ii) the `altova:evaluate` function's arguments (see *signature above*), from the second argument onwards, provide the values of the variables, with the sequence of the arguments corresponding to the numerically ordered sequence of variables: `p1` to `pN`: The second argument will be the value of the variable `p1`, the third argument that of the variable `p2`, and so on; (iii) The variable values must be of type `item*`.

▣ Example

```
<xsl:variable name="xpath" select="'$p3, $p2, $p1'" />
<xsl:value-of select="altova:evaluate($xpath, 10, 20, 'hi')" />
outputs "hi 20 10"
```

In the listing above, notice the following:

- The second argument of the `altova:evaluate` expression is the value assigned to the variable `$p1`, the third argument that assigned to the variable `$p2`, and so on.
- Notice that the fourth argument of the function is a string value, indicated by its being enclosed in quotes.
- The `select` attribute of the `xs:variable` element supplies the XPath expression. Since this expression must be of type `xs:string`, it is enclosed in single quotes.

▣ Examples to further illustrate the use of variables

```
• <xsl:variable name="xpath" select="'$p1'" />
  <xsl:value-of select="altova:evaluate($xpath, //Name[1])" />
  Outputs value of the first Name element.

• <xsl:variable name="xpath" select="'$p1'" />
  <xsl:value-of select="altova:evaluate($xpath, '//Name[1]')" />
  Outputs "//Name[1]"
```

The `altova:evaluate()` extension function is useful in situations where an XPath expression in the XSLT stylesheet contains one or more parts that must be evaluated dynamically. For example, consider a situation in which a user enters his request for the sorting criterion and this criterion is stored in the attribute `UserReq/@sortkey`. In the stylesheet, you could then have the expression: `<xsl:sort select="altova:evaluate(../UserReq/@sortkey)" order="ascending"/>`. The `altova:evaluate()` function reads the `sortkey` attribute of the `UserReq` child element of the parent of the context node. Say the value of the `sortkey` attribute is `Price`, then `Price` is returned by the `altova:evaluate()` function and becomes the value of the `select` attribute: `<xsl:sort select="Price" order="ascending"/>`. If this `sort` instruction occurs within the context of an element called `Order`, then the `Order` elements will be sorted according to the values of their `Price` children. Alternatively, if the value of `@sortkey` were, say, `Date`, then the `Order` elements would be sorted according to the values of their `Date` children. So the sort criterion for `Order` is selected from the `sortkey` attribute at runtime. This could not have been achieved with an expression like: `<xsl:sort select="../UserReq/@sortkey" order="ascending"/>`. In the case shown above, the sort criterion would be the `sortkey` attribute itself, not `Price` or `Date` (or any other current content of `sortkey`).

Note: The static context includes namespaces, types, and functions—but not variables—from the calling environment. The base URI and default namespace are inherited.

▣ More examples

- Static variables: `<xsl:value-of select="$i3, $i2, $i1" />`
Outputs the values of three variables.
- Dynamic XPath expression with dynamic variables:
`<xsl:variable name="xpath" select="'$p3, $p2, $p1'" />`

```
<xsl:value-of select="altova:evaluate($xpath, 10, 20, 30)" />  
Outputs "30 20 10"
```

- Dynamic XPath expression with no dynamic variable:

```
<xsl:variable name="xpath" select="'$p3, $p2, $p1'" />  
<xsl:value-of select="altova:evaluate($xpath)" />  
Outputs error: No variable defined for $p3.
```

▼ encode-for-rtf [altova:]

```
altova:encode-for-rtf(input as xs:string, preserveallwhitespace as xs:boolean,  
preservenewlines as xs:boolean) as xs:string XSLT2 XSLT3
```

Converts the input string into code for RTF. Whitespace and new lines will be preserved according to the boolean value specified for their respective arguments.

[[Top](#)¹⁵⁵⁵]

XBRL functions

Altova XBRL functions can be used only with editions of Altova products that have XBRL support.

▼ xbrl-footnotes [altova:]

```
altova:xbrl-footnotes(node()) as node()* XSLT2 XSLT3
```

Takes a node as its input argument and returns the set of XBRL footnote nodes referenced by the input node.

▼ xbrl-labels [altova:]

```
altova:xbrl-labels(xs:QName, xs:string) as node()* XSLT2 XSLT3
```

Takes two input arguments: a node name and the taxonomy file location containing the node. The function returns the XBRL label nodes associated with the input node.

[[Top](#)¹⁵⁵⁵]

27.2.1.2 XPath/XQuery Functions: Date and Time

Altova's date/time extension functions can be used in XPath and XQuery expressions and provide additional functionality for the processing of data held as XML Schema's various date and time datatypes. The functions in this section can be used with Altova's **XPath 3.0** and **XQuery 3.0** engines. They are available in XPath/XQuery contexts.

Note about naming of functions and language applicability

Altova extension functions can be used in XPath/XQuery expressions. They provide additional functionality to

the functionality that is available in the standard library of XPath, XQuery, and XSLT functions. Altova extension functions are in the **Altova extension functions namespace**, <http://www.altova.com/xslt-extensions>, and are indicated in this section with the prefix **altova:**, which is assumed to be bound to this namespace. Note that, in future versions of your product, support for a function might be discontinued or the behavior of individual functions might change. Consult the documentation of future releases for information about support for Altova extension functions in that release.

| | |
|---|--------------------------|
| <i>XPath functions (used in XPath expressions in XSLT):</i> | XP1 XP2 XP3.1 |
| <i>XSLT functions (used in XPath expressions in XSLT):</i> | XSLT1 XSLT2 XSLT3 |
| <i>XQuery functions (used in XQuery expressions in XQuery):</i> | XQ1 XQ3.1 |

▼ Grouped by functionality

- [Add a duration to xs:dateTime and return xs:dateTime](#) ¹⁵⁵⁹
- [Add a duration to xs:date and return xs:date](#) ¹⁵⁶¹
- [Add a duration to xs:time and return xs:time](#) ¹⁵⁶²
- [Format and retrieve durations](#) ¹⁵⁶¹
- [Remove timezone from functions that generate current date/time](#) ¹⁵⁶³
- [Return days, hours, minutes, and seconds from durations](#) ¹⁵⁶⁴
- [Return weekday as integer from date](#) ¹⁵⁶⁶
- [Return week number as integer from date](#) ¹⁵⁶⁶
- [Build date, time, or duration type from lexical components of each type](#) ¹⁵⁶⁸
- [Construct date, dateTime, or time type from string input](#) ¹⁵⁷⁰
- [Age-related functions](#) ¹⁵⁷¹
- [Epoch time \(Unix time\) functions](#) ¹⁵⁷³

▼ Listed alphabetically

- [altova:add-days-to-date](#) ¹⁵⁶¹
- [altova:add-days-to-dateTime](#) ¹⁵⁵⁹
- [altova:add-hours-to-dateTime](#) ¹⁵⁵⁹
- [altova:add-hours-to-time](#) ¹⁵⁶²
- [altova:add-minutes-to-dateTime](#) ¹⁵⁵⁹
- [altova:add-minutes-to-time](#) ¹⁵⁶²
- [altova:add-months-to-date](#) ¹⁵⁶¹
- [altova:add-months-to-dateTime](#) ¹⁵⁵⁹
- [altova:add-seconds-to-dateTime](#) ¹⁵⁵⁹
- [altova:add-seconds-to-time](#) ¹⁵⁶²
- [altova:add-years-to-date](#) ¹⁵⁶¹
- [altova:add-years-to-dateTime](#) ¹⁵⁵⁹
- [altova:age](#) ¹⁵⁷¹
- [altova:age-details](#) ¹⁵⁷¹
- [altova:build-date](#) ¹⁵⁶⁸
- [altova:build-duration](#) ¹⁵⁶⁸
- [altova:build-time](#) ¹⁵⁶⁸
- [altova:current-dateTime-no-TZ](#) ¹⁵⁶³
- [altova:current-date-no-TZ](#) ¹⁵⁶³
- [altova:current-time-no-TZ](#) ¹⁵⁶³
- [altova:date-no-TZ](#) ¹⁵⁶³
- [altova:dateTime-from-epoch](#) ¹⁵⁷³
- [altova:dateTime-from-epoch-no-TZ](#) ¹⁵⁷³
- [altova:dateTime-no-TZ](#) ¹⁵⁶³

[altova:days-in-month](#)¹⁵⁶⁴
[altova:epoch-from-dateTime](#)¹⁵⁷³
[altova:hours-from-dateTimeDuration-accumulated](#)¹⁵⁶⁴
[altova:minutes-from-dateTimeDuration-accumulated](#)¹⁵⁶⁴
[altova:seconds-from-dateTimeDuration-accumulated](#)¹⁵⁶⁴
[altova:format-duration](#)¹⁵⁶¹
[altova:parse-date](#)¹⁵⁷⁰
[altova:parse-dateTime](#)¹⁵⁷⁰
[altova:parse-duration](#)¹⁵⁶¹
[altova:parse-time](#)¹⁵⁷⁰
[altova:time-no-TZ](#)¹⁵⁶³
[altova:weekday-from-date](#)¹⁵⁶⁶
[altova:weekday-from-dateTime](#)¹⁵⁶⁶
[altova:weeknumber-from-date](#)¹⁵⁶⁷
[altova:weeknumber-from-dateTime](#)¹⁵⁶⁷

[[Top](#)¹⁵⁵⁷]

Add a duration to xs:dateTime **XP3.1 XQ3.1**

These functions add a duration to `xs:dateTime` and return `xs:dateTime`. The `xs:dateTime` type has a format of `CCYY-MM-DDThh:mm:ss.sss`. This is a concatenation of the `xs:date` and `xs:time` formats separated by the letter `T`. A timezone suffix (`+01:00`, for example) is optional.

▼ `add-years-to-dateTime` [`altova:`]

`altova:add-years-to-dateTime` (`DateTime` as `xs:dateTime`, `Years` as `xs:integer`) as `xs:dateTime` **XP3.1 XQ3.1**

Adds a duration in years to an `xs:dateTime` (see examples below). The second argument is the number of years to be added to the `xs:dateTime` supplied as the first argument. The result is of type `xs:dateTime`.

▣ Examples

- **`altova:add-years-to-dateTime`** (`xs:dateTime`("2014-01-15T14:00:00"), 10) returns 2024-01-15T14:00:00
- **`altova:add-years-to-dateTime`** (`xs:dateTime`("2014-01-15T14:00:00"), -4) returns 2010-01-15T14:00:00

▼ `add-months-to-dateTime` [`altova:`]

`altova:add-months-to-dateTime` (`DateTime` as `xs:dateTime`, `Months` as `xs:integer`) as `xs:dateTime` **XP3.1 XQ3.1**

Adds a duration in months to an `xs:dateTime` (see examples below). The second argument is the number of months to be added to the `xs:dateTime` supplied as the first argument. The result is of type `xs:dateTime`.

▣ Examples

- **`altova:add-months-to-dateTime`** (`xs:dateTime`("2014-01-15T14:00:00"), 10) returns 2014-11-15T14:00:00
- **`altova:add-months-to-dateTime`** (`xs:dateTime`("2014-01-15T14:00:00"), -2) returns 2013-11-15T14:00:00

▼ `add-days-to-dateTime` [altova:]

`altova:add-days-to-dateTime` (`DateTime` as `xs:dateTime`, `Days` as `xs:integer`) as `xs:dateTime`
XP3.1 XQ3.1

Adds a duration in days to an `xs:dateTime` (see examples below). The second argument is the number of days to be added to the `xs:dateTime` supplied as the first argument. The result is of type `xs:dateTime`.

☐ Examples

- `altova:add-days-to-dateTime` (`xs:dateTime`("2014-01-15T14:00:00"), 10) returns 2014-01-25T14:00:00
- `altova:add-days-to-dateTime` (`xs:dateTime`("2014-01-15T14:00:00"), -8) returns 2014-01-07T14:00:00

▼ `add-hours-to-dateTime` [altova:]

`altova:add-hours-to-dateTime` (`DateTime` as `xs:dateTime`, `Hours` as `xs:integer`) as `xs:dateTime`
XP3.1 XQ3.1

Adds a duration in hours to an `xs:dateTime` (see examples below). The second argument is the number of hours to be added to the `xs:dateTime` supplied as the first argument. The result is of type `xs:dateTime`.

☐ Examples

- `altova:add-hours-to-dateTime` (`xs:dateTime`("2014-01-15T13:00:00"), 10) returns 2014-01-15T23:00:00
- `altova:add-hours-to-dateTime` (`xs:dateTime`("2014-01-15T13:00:00"), -8) returns 2014-01-15T05:00:00

▼ `add-minutes-to-dateTime` [altova:]

`altova:add-minutes-to-dateTime` (`DateTime` as `xs:dateTime`, `Minutes` as `xs:integer`) as `xs:dateTime`
XP3.1 XQ3.1

Adds a duration in minutes to an `xs:dateTime` (see examples below). The second argument is the number of minutes to be added to the `xs:dateTime` supplied as the first argument. The result is of type `xs:dateTime`.

☐ Examples

- `altova:add-minutes-to-dateTime` (`xs:dateTime`("2014-01-15T14:10:00"), 45) returns 2014-01-15T14:55:00
- `altova:add-minutes-to-dateTime` (`xs:dateTime`("2014-01-15T14:10:00"), -5) returns 2014-01-15T14:05:00

▼ `add-seconds-to-dateTime` [altova:]

`altova:add-seconds-to-dateTime` (`DateTime` as `xs:dateTime`, `Seconds` as `xs:integer`) as `xs:dateTime`
XP3.1 XQ3.1

Adds a duration in seconds to an `xs:dateTime` (see examples below). The second argument is the number of seconds to be added to the `xs:dateTime` supplied as the first argument. The result is of type `xs:dateTime`.

☐ Examples

- `altova:add-seconds-to-dateTime` (`xs:dateTime`("2014-01-15T14:00:10"), 20) returns 2014-01-15T14:00:30

- **altova:add-seconds-to-dateTime** (`xs:dateTime("2014-01-15T14:00:10")`, -5) returns `2014-01-15T14:00:05`

[[Top](#)¹⁵⁵⁷]

Add a duration to `xs:date` [XP3.1](#) [XQ3.1](#)

These functions add a duration to `xs:date` and return `xs:date`. The `xs:date` type has a format of CCYY-MM-DD.

▼ add-years-to-date [altova:]

altova:add-years-to-date (*Date as xs:date, Years as xs:integer*) as `xs:date` [XP3.1](#) [XQ3.1](#)

Adds a duration in years to a date. The second argument is the number of years to be added to the `xs:date` supplied as the first argument. The result is of type `xs:date`.

▣ Examples

- **altova:add-years-to-date** (`xs:date("2014-01-15")`, 10) returns `2024-01-15`
- **altova:add-years-to-date** (`xs:date("2014-01-15")`, -4) returns `2010-01-15`

▼ add-months-to-date [altova:]

altova:add-months-to-date (*Date as xs:date, Months as xs:integer*) as `xs:date` [XP3.1](#) [XQ3.1](#)

Adds a duration in months to a date. The second argument is the number of months to be added to the `xs:date` supplied as the first argument. The result is of type `xs:date`.

▣ Examples

- **altova:add-months-to-date** (`xs:date("2014-01-15")`, 10) returns `2014-11-15`
- **altova:add-months-to-date** (`xs:date("2014-01-15")`, -2) returns `2013-11-15`

▼ add-days-to-date [altova:]

altova:add-days-to-date (*Date as xs:date, Days as xs:integer*) as `xs:date` [XP3.1](#) [XQ3.1](#)

Adds a duration in days to a date. The second argument is the number of days to be added to the `xs:date` supplied as the first argument. The result is of type `xs:date`.

▣ Examples

- **altova:add-days-to-date** (`xs:date("2014-01-15")`, 10) returns `2014-01-25`
- **altova:add-days-to-date** (`xs:date("2014-01-15")`, -8) returns `2014-01-07`

[[Top](#)¹⁵⁵⁷]

Format and retrieve durations [XP3.1](#) [XQ3.1](#)

These functions parse an input `xs:duration` or `xs:string` and return, respectively, an `xs:string` or `xs:duration`.

▼ `format-duration` [altova:]

`altova:format-duration`(Duration as *xs:duration*, Picture as *xs:string*) as *xs:string* **XP3.1**
XQ3.1

Formats a duration, which is submitted as the first argument, according to a picture string submitted as the second argument. The output is a text string formatted according to the picture string.

☐ Examples

- `altova:format-duration`(`xs:duration("P2DT2H53M11.7S")`, `"Days:[D01] Hours:[H01] Minutes:[m01] Seconds:[s01] Fractions:[f0]"`) returns `"Days:02 Hours:02 Minutes:53 Seconds:11 Fractions:7"`
- `altova:format-duration`(`xs:duration("P3M2DT2H53M11.7S")`, `"Months:[M01] Days:[D01] Hours:[H01] Minutes:[m01]"`) returns `"Months:03 Days:02 Hours:02 Minutes:53"`

▼ `parse-duration` [altova:]

`altova:parse-duration`(InputString as *xs:string*, Picture as *xs:string*) as *xs:duration* **XP3.1** **XQ3.1**

Takes a patterned string as the first argument, and a picture string as the second argument. The input string is parsed on the basis of the picture string, and an *xs:duration* is returned.

☐ Examples

- `altova:parse-duration`(`"Days:02 Hours:02 Minutes:53 Seconds:11 Fractions:7"`, `"Days:[D01] Hours:[H01] Minutes:[m01] Seconds:[s01] Fractions:[f0]"`) returns `"P2DT2H53M11.7S"`
- `altova:parse-duration`(`"Months:03 Days:02 Hours:02 Minutes:53 Seconds:11 Fractions:7"`, `"Months:[M01] Days:[D01] Hours:[H01] Minutes:[m01]"`) returns `"P3M2DT2H53M"`

[[Top](#)¹⁵⁵⁷]

Add a duration to *xs:time* **XP3.1** **XQ3.1**

These functions add a duration to *xs:time* and return *xs:time*. The *xs:time* type has a lexical form of `hh:mm:ss.sss`. An optional time zone may be suffixed. The letter `Z` indicates Coordinated Universal Time (UTC). All other time zones are represented by their difference from UTC in the format `+hh:mm`, or `-hh:mm`. If no time zone value is present, it is considered unknown; it is not assumed to be UTC.

▼ `add-hours-to-time` [altova:]

`altova:add-hours-to-time`(Time as *xs:time*, Hours as *xs:integer*) as *xs:time* **XP3.1** **XQ3.1**

Adds a duration in hours to a time. The second argument is the number of hours to be added to the *xs:time* supplied as the first argument. The result is of type *xs:time*.

☐ Examples

- `altova:add-hours-to-time`(`xs:time("11:00:00")`, `10`) returns `21:00:00`
- `altova:add-hours-to-time`(`xs:time("11:00:00")`, `-7`) returns `04:00:00`

▼ `add-minutes-to-time` [altova:]

`altova:add-minutes-to-time`(Time as *xs:time*, Minutes as *xs:integer*) as *xs:time* **XP3.1** **XQ3.1**

Adds a duration in minutes to a time. The second argument is the number of minutes to be added to the `xs:time` supplied as the first argument. The result is of type `xs:time`.

▣ Examples

- `altova:add-minutes-to-time(xs:time("14:10:00"), 45)` returns `14:55:00`
- `altova:add-minutes-to-time(xs:time("14:10:00"), -5)` returns `14:05:00`

▼ `add-seconds-to-time` [altova:]

`altova:add-seconds-to-time` (Time as `xs:time`, Minutes as `xs:integer`) as `xs:time` **XP3.1** **XQ3.1**

Adds a duration in seconds to a time. The second argument is the number of seconds to be added to the `xs:time` supplied as the first argument. The result is of type `xs:time`. The Seconds component can be in the range of 0 to 59.999.

▣ Examples

- `altova:add-seconds-to-time(xs:time("14:00:00"), 20)` returns `14:00:20`
- `altova:add-seconds-to-time(xs:time("14:00:00"), 20.895)` returns `14:00:20.895`

[[Top](#) ¹⁵⁵⁷]

Remove the timezone part from date/time datatypes **XP3.1** **XQ3.1**

These functions remove the timezone from the current `xs:dateTime`, `xs:date`, or `xs:time` values, respectively. Note that the difference between `xs:dateTime` and `xs:dateTimeStamp` is that in the case of the latter the timezone part is required (while it is optional in the case of the former). So the format of an `xs:dateTimeStamp` value is: `CCYY-MM-DDThh:mm:ss.sss±hh:mm`. or `CCYY-MM-DDThh:mm:ss.sssZ`. If the date and time is read from the system clock as `xs:dateTimeStamp`, the `current-dateTime-no-TZ()` function can be used to remove the timezone if so required.

▼ `current-date-no-TZ` [altova:]

`altova:current-date-no-TZ()` as `xs:date` **XP3.1** **XQ3.1**

This function takes no argument. It removes the timezone part of `current-date()` (which is the current date according to the system clock) and returns an `xs:date` value.

▣ Examples

If the current date is `2014-01-15+01:00`:

- `altova:current-date-no-TZ()` returns `2014-01-15`

▼ `current-dateTime-no-TZ` [altova:]

`altova:current-dateTime-no-TZ()` as `xs:dateTime` **XP3.1** **XQ3.1**

This function takes no argument. It removes the timezone part of `current-dateTime()` (which is the current date-and-time according to the system clock) and returns an `xs:dateTime` value.

▣ Examples

If the current `dateTime` is `2014-01-15T14:00:00+01:00`:

- `altova:current-dateTime-no-TZ()` returns `2014-01-15T14:00:00`

▼ `current-time-no-TZ` [altova:]

`altova:current-time-no-TZ()` as `xs:time` **XP3.1** **XQ3.1**

This function takes no argument. It removes the timezone part of `current-time()` (which is the current time according to the system clock) and returns an `xs:time` value.

☐ Examples

If the current time is `14:00:00+01:00`:

- `altova:current-time-no-TZ()` returns `14:00:00`

▼ `date-no-TZ` [altova:]

`altova:date-no-TZ(InputDate as xs:date) as xs:date` **XP3.1** **XQ3.1**

This function takes an `xs:date` argument, removes the timezone part from it, and returns an `xs:date` value. Note that the date is not modified.

☐ Examples

- `altova:date-no-TZ(xs:date("2014-01-15+01:00"))` returns `2014-01-15`

▼ `dateTime-no-TZ` [altova:]

`altova:dateTime-no-TZ(InputDateTime as xs:dateTime) as xs:dateTime` **XP3.1** **XQ3.1**

This function takes an `xs:dateTime` argument, removes the timezone part from it, and returns an `xs:dateTime` value. Note that neither the date nor the time is modified.

☐ Examples

- `altova:dateTime-no-TZ(xs:date("2014-01-15T14:00:00+01:00"))` returns `2014-01-15T14:00:00`

▼ `time-no-TZ` [altova:]

`altova:time-no-TZ(InputTime as xs:time) as xs:time` **XP3.1** **XQ3.1**

This function takes an `xs:time` argument, removes the timezone part from it, and returns an `xs:time` value. Note that the time is not modified.

☐ Examples

- `altova:time-no-TZ(xs:time("14:00:00+01:00"))` returns `14:00:00`

[[Top](#)¹⁵⁵⁷]

Return the number of days, hours, minutes, seconds from durations **XP3.1** **XQ3.1**

These functions return the number of days in a month, and the number of hours, minutes, and seconds, respectively, from durations.

▼ days-in-month [altova:]

altova:days-in-month(Year as xs:integer, Month as xs:integer) as xs:integer **XP3.1 XQ3.1**

Returns the number of days in the specified month. The month is specified by means of the Year and Month arguments.

☐ Examples

- **altova:days-in-month**(2018, 10) returns 31
- **altova:days-in-month**(2018, 2) returns 28
- **altova:days-in-month**(2020, 2) returns 29

▼ hours-from-dayTimeDuration-accumulated

altova:hours-from-dayTimeDuration-accumulated(DayAndTime as xs:duration) as xs:integer **XP3.1 XQ3.1**

Returns the total number of hours in the duration submitted by the DayAndTime argument (which is of type xs:duration). The hours in the Day and Time components are added together to give a result that is an integer. A new hour is counted only for a full 60 minutes. Negative durations result in a negative hour value.

☐ Examples

- **altova:hours-from-dayTimeDuration-accumulated**(xs:duration("P5D")) returns 120, which is the total number of hours in 5 days.
- **altova:hours-from-dayTimeDuration-accumulated**(xs:duration("P5DT2H")) returns 122, which is the total number of hours in 5 days plus 2 hours.
- **altova:hours-from-dayTimeDuration-accumulated**(xs:duration("P5DT2H60M")) returns 123, which is the total number of hours in 5 days plus 2 hours and 60 mins.
- **altova:hours-from-dayTimeDuration-accumulated**(xs:duration("P5DT2H119M")) returns 123, which is the total number of hours in 5 days plus 2 hours and 119 mins.
- **altova:hours-from-dayTimeDuration-accumulated**(xs:duration("P5DT2H120M")) returns 124, which is the total number of hours in 5 days plus 2 hours and 120 mins.
- **altova:hours-from-dayTimeDuration-accumulated**(xs:duration("-P5DT2H")) returns -122

▼ minutes-from-dayTimeDuration-accumulated

altova:minutes-from-dayTimeDuration-accumulated(DayAndTime as xs:duration) as xs:integer **XP3.1 XQ3.1**

Returns the total number of minutes in the duration submitted by the DayAndTime argument (which is of type xs:duration). The minutes in the Day and Time components are added together to give a result that is an integer. Negative durations result in a negative minute value.

☐ Examples

- **altova:minutes-from-dayTimeDuration-accumulated**(xs:duration("PT60M")) returns 60
- **altova:minutes-from-dayTimeDuration-accumulated**(xs:duration("PT1H")) returns 60, which is the total number of minutes in 1 hour.
- **altova:minutes-from-dayTimeDuration-accumulated**(xs:duration("PT1H40M")) returns 100
- **altova:minutes-from-dayTimeDuration-accumulated**(xs:duration("P1D")) returns 1440, which is the total number of minutes in 1 day.
- **altova:minutes-from-dayTimeDuration-accumulated**(xs:duration("-P1DT60M")) returns -1500

▼ seconds-from-dayTimeDuration-accumulated

altova:seconds-from-dayTimeDuration-accumulated(DayAndTime as xs:duration) as xs:integer **XP3.1 XQ3.1**

Returns the total number of seconds in the duration submitted by the DayAndTime argument (which is of type xs:duration). The seconds in the Day and Time components are added together to give a result that is an integer. Negative durations result in a negative seconds value.

☐ Examples

- **altova:seconds-from-dayTimeDuration-accumulated**(xs:duration("PT1M")) returns 60, which is the total number of seconds in 1 minute.
- **altova:seconds-from-dayTimeDuration-accumulated**(xs:duration("PT1H")) returns 3600, which is the total number of seconds in 1 hour.
- **altova:seconds-from-dayTimeDuration-accumulated**(xs:duration("PT1H2M")) returns 3720
- **altova:seconds-from-dayTimeDuration-accumulated**(xs:duration("P1D")) returns 86400, which is the total number of seconds in 1 day.
- **altova:seconds-from-dayTimeDuration-accumulated**(xs:duration("-P1DT1M")) returns -86460

Return the weekday from xs:dateTime or xs:date **XP3.1 XQ3.1**

These functions return the weekday (as an integer) from xs:dateTime or xs:date. The days of the week are numbered (using the American format) from 1 to 7, with Sunday=1. In the European format, the week starts with Monday (=1). The American format, where Sunday=1, can be set by using the integer 0 where an integer is accepted to indicate the format.

▼ weekday-from-dateTime [altova:]

altova:weekday-from-dateTime(DateTime as xs:dateTime) as xs:integer **XP3.1 XQ3.1**

Takes a date-with-time as its single argument and returns the day of the week of this date as an integer. The weekdays are numbered starting with Sunday=1. If the European format is required (where Monday=1), use the other signature of this function (see next signature below).

☐ Examples

- **altova:weekday-from-dateTime**(xs:dateTime("2014-02-03T09:00:00")) returns 2, which would indicate a Monday.

altova:weekday-from-dateTime(DateTime as xs:dateTime, Format as xs:integer) as xs:integer **XP3.1 XQ3.1**

Takes a date-with-time as its first argument and returns the day of the week of this date as an integer. If the second (integer) argument is 0, then the weekdays are numbered 1 to 7 starting with Sunday=1. If the second argument is an integer other than 0, then Monday=1. If there is no second argument, the function is read as having the other signature of this function (see previous signature).

☐ Examples

- **altova:weekday-from-dateTime**(xs:dateTime("2014-02-03T09:00:00"), 1) returns 1, which would indicate a Monday
- **altova:weekday-from-dateTime**(xs:dateTime("2014-02-03T09:00:00"), 4) returns 1, which would indicate a Monday
- **altova:weekday-from-dateTime**(xs:dateTime("2014-02-03T09:00:00"), 0) returns 2, which would indicate a Monday.

▼ weekday-from-date [altova:]

altova:weekday-from-date(Date as xs:date) as xs:integer **XP3.1 XQ3.1**

Takes a date as its single argument and returns the day of the week of this date as an integer. The weekdays are numbered starting with Sunday=1. If the European format is required (where Monday=1), use the other signature of this function (see next signature below).

☐ Examples

- **altova:weekday-from-date**(xs:date("2014-02-03+01:00")) returns 2, which would indicate a Monday.

altova:weekday-from-date(Date as xs:date, Format as xs:integer) as xs:integer **XP3.1 XQ3.1**

Takes a date as its first argument and returns the day of the week of this date as an integer. If the second (Format) argument is 0, then the weekdays are numbered 1 to 7 starting with Sunday=1. If the second argument is an integer other than 0, then Monday=1. If there is no second argument, the function is read as having the other signature of this function (see previous signature).

☐ Examples

- **altova:weekday-from-date**(xs:date("2014-02-03"), 1) returns 1, which would indicate a Monday
- **altova:weekday-from-date**(xs:date("2014-02-03"), 4) returns 1, which would indicate a Monday
- **altova:weekday-from-date**(xs:date("2014-02-03"), 0) returns 2, which would indicate a Monday.

[[Top](#)¹⁵⁵⁷]

Return the week number from xs:dateTime or xs:date **XP2 XQ1 XP3.1 XQ3.1**

These functions return the week number (as an integer) from xs:dateTime or xs:date. Week-numbering is available in the US, ISO/European, and Islamic calendar formats. Week-numbering is different in these calendar formats because the week is considered to start on different days (on Sunday in the US format, Monday in the ISO/European format, and Saturday in the Islamic format).

▼ weeknumber-from-date [altova:]

altova:weeknumber-from-date(Date as xs:date, Calendar as xs:integer) as xs:integer **XP2 XQ1 XP3.1 XQ3.1**

Returns the week number of the submitted Date argument as an integer. The second argument (Calendar) specifies the calendar system to follow.

Supported Calendar values are:

- 0 = US calendar (week starts Sunday)
- 1 = ISO standard, European calendar (week starts Monday)
- 2 = Islamic calendar (week starts Saturday)

Default is 0.

Examples

- `altova:weeknumber-from-date(xs:date("2014-03-23"), 0)` returns 13
- `altova:weeknumber-from-date(xs:date("2014-03-23"), 1)` returns 12
- `altova:weeknumber-from-date(xs:date("2014-03-23"), 2)` returns 13
- `altova:weeknumber-from-date(xs:date("2014-03-23"))` returns 13

The day of the date in the examples above (2014-03-23) is Sunday. So the US and Islamic calendars are one week ahead of the European calendar on this day.

weeknumber-from-dateTime [altova:]

`altova:weeknumber-from-dateTime(DateTime as xs:dateTime, Calendar as xs:integer) as xs:integer` [XP2](#) [XQ1](#) [XP3.1](#) [XQ3.1](#)

Returns the week number of the submitted `DateTime` argument as an integer. The second argument (`Calendar`) specifies the calendar system to follow.

Supported `calendar` values are:

- 0 = US calendar (*week starts Sunday*)
- 1 = ISO standard, European calendar (*week starts Monday*)
- 2 = Islamic calendar (*week starts Saturday*)

Default is 0.

Examples

- `altova:weeknumber-from-dateTime(xs:dateTime("2014-03-23T00:00:00"), 0)` returns 13
- `altova:weeknumber-from-dateTime(xs:dateTime("2014-03-23T00:00:00"), 1)` returns 12
- `altova:weeknumber-from-dateTime(xs:dateTime("2014-03-23T00:00:00"), 2)` returns 13
- `altova:weeknumber-from-dateTime(xs:dateTime("2014-03-23T00:00:00"))` returns 13

The day of the `dateTime` in the examples above (2014-03-23T00:00:00) is Sunday. So the US and Islamic calendars are one week ahead of the European calendar on this day.

[[Top](#)¹⁵⁵⁷]

Build date, time, and duration datatypes from their lexical components [XP3.1](#) [XQ3.1](#)

The functions take the lexical components of the `xs:date`, `xs:time`, or `xs:duration` datatype as input arguments and combine them to build the respective datatype.

build-date [altova:]

`altova:build-date(Year as xs:integer, Month as xs:integer, Date as xs:integer) as xs:date` [XP3.1](#) [XQ3.1](#)

The first, second, and third arguments are, respectively, the year, month, and date. They are combined to build a value of `xs:date` type. The values of the integers must be within the correct range of that particular date part. For example, the second argument (for the month part) should not be greater than 12.

Examples

- `altova:build-date(2014, 2, 03)` returns 2014-02-03

▼ build-time [altova:]

altova:build-time(Hours as xs:integer, Minutes as xs:integer, Seconds as xs:integer) as xs:time XP3.1 XQ3.1

The first, second, and third arguments are, respectively, the hour (0 to 23), minutes (0 to 59), and seconds (0 to 59) values. They are combined to build a value of xs:time type. The values of the integers must be within the correct range of that particular time part. For example, the second (Minutes) argument should not be greater than 59. To add a timezone part to the value, use the other signature of this function (see next signature).

☐ Examples

- **altova:build-time**(23, 4, 57) returns 23:04:57

altova:build-time(Hours as xs:integer, Minutes as xs:integer, Seconds as xs:integer, TimeZone as xs:string) as xs:time XP3.1 XQ3.1

The first, second, and third arguments are, respectively, the hour (0 to 23), minutes (0 to 59), and seconds (0 to 59) values. The fourth argument is a string that provides the timezone part of the value. The four arguments are combined to build a value of xs:time type. The values of the integers must be within the correct range of that particular time part. For example, the second (Minutes) argument should not be greater than 59.

☐ Examples

- **altova:build-time**(23, 4, 57, '+1') returns 23:04:57+01:00

▼ build-duration [altova:]

altova:build-duration(Years as xs:integer, Months as xs:integer) as xs:yearMonthDuration XP3.1 XQ3.1

Takes two arguments to build a value of type xs:yearMonthDuration. The first argument provides the Years part of the duration value, while the second argument provides the Months part. If the second (Months) argument is greater than or equal to 12, then the integer is divided by 12; the quotient is added to the first argument to provide the Years part of the duration value while the remainder (of the division) provides the Months part. To build a duration of type xs:dayTimeDuration., see the next signature.

☐ Examples

- **altova:build-duration**(2, 10) returns P2Y10M
- **altova:build-duration**(14, 27) returns P16Y3M
- **altova:build-duration**(2, 24) returns P4Y

altova:build-duration(Days as xs:integer, Hours as xs:integer, Minutes as xs:integer, Seconds as xs:integer) as xs:dayTimeDuration XP3.1 XQ3.1

Takes four arguments and combines them to build a value of type xs:dayTimeDuration. The first argument provides the Days part of the duration value, the second, third, and fourth arguments provide, respectively, the Hours, Minutes, and Seconds parts of the duration value. Each of the three Time arguments is converted to an equivalent value in terms of the next higher unit and the result is used for calculation of the total duration value. For example, 72 seconds is converted to 1M+12S (1 minute and 12 seconds), and this value is used for calculation of the total duration value. To build a duration of type xs:yearMonthDuration., see the previous signature.

☐ Examples

- `altova:build-duration(2, 10, 3, 56)` returns `P2DT10H3M56S`
- `altova:build-duration(1, 0, 100, 0)` returns `P1DT1H40M`
- `altova:build-duration(1, 0, 0, 3600)` returns `P1DT1H`

[[Top](#) ¹⁵⁵⁷]

Construct date, dateTime, and time datatypes from string input [XP2](#) [XQ1](#) [XP3.1](#) [XQ3.1](#)

These functions take strings as arguments and construct `xs:date`, `xs:dateTime`, or `xs:time` datatypes. The string is analyzed for components of the datatype based on a submitted pattern argument.

▼ parse-date [altova:]

`altova:parse-date(Date as xs:string, DatePattern as xs:string) as xs:date` [XP2](#) [XQ1](#) [XP3.1](#) [XQ3.1](#)

Returns the input string `Date` as an `xs:date` value. The second argument `DatePattern` specifies the pattern (sequence of components) of the input string. `DatePattern` is described with the component specifiers listed below and with component separators that can be any character. See the examples below.

| | |
|---|-------|
| D | Date |
| M | Month |
| Y | Year |

The pattern in `DatePattern` must match the pattern in `Date`. Since the output is of type `xs:date`, the output will always have the lexical format `YYYY-MM-DD`.

☐ Examples

- `altova:parse-date(xs:string("09-12-2014"), "[D]-[M]-[Y]")` returns `2014-12-09`
- `altova:parse-date(xs:string("09-12-2014"), "[M]-[D]-[Y]")` returns `2014-09-12`
- `altova:parse-date("06/03/2014", "[M]/[D]/[Y]")` returns `2014-06-03`
- `altova:parse-date("06 03 2014", "[M] [D] [Y]")` returns `2014-06-03`
- `altova:parse-date("6 3 2014", "[M] [D] [Y]")` returns `2014-06-03`

▼ parse-dateTime [altova:]

`altova:parse-dateTime(DateTime as xs:string, DateTimePattern as xs:string) as xs:dateTime` [XP2](#) [XQ1](#) [XP3.1](#) [XQ3.1](#)

Returns the input string `DateTime` as an `xs:dateTime` value. The second argument `DateTimePattern` specifies the pattern (sequence of components) of the input string. `DateTimePattern` is described with the component specifiers listed below and with component separators that can be any character. See the examples below.

| | |
|---|---------|
| D | Date |
| M | Month |
| Y | Year |
| H | Hour |
| m | minutes |

s seconds

The pattern in `DateTimePattern` must match the pattern in `DateTime`. Since the output is of type `xs:dateTime`, the output will always have the lexical format `YYYY-MM-DDTHH:mm:ss`.

Examples

- `altova:parse-dateTime(xs:string("09-12-2014 13:56:24"), "[M]-[D]-[Y] [H]:[m]:[s]")` returns `2014-09-12T13:56:24`
- `altova:parse-dateTime("time=13:56:24; date=09-12-2014", "time=[H]:[m]:[s]; date=[D]-[M]-[Y]")` returns `2014-12-09T13:56:24`

▼ parse-time [altova:]

`altova:parse-time(Time as xs:string, TimePattern as xs:string) as xs:time` [XP2](#) [XQ1](#) [XP3.1](#) [XQ3.1](#)

Returns the input string `Time` as an `xs:time` value. The second argument `TimePattern` specifies the pattern (sequence of components) of the input string. `TimePattern` is described with the component specifiers listed below and with component separators that can be any character. See the examples below.

| | |
|---|---------|
| H | Hour |
| m | minutes |
| s | seconds |

The pattern in `TimePattern` must match the pattern in `Time`. Since the output is of type `xs:time`, the output will always have the lexical format `HH:mm:ss`.

Examples

- `altova:parse-time(xs:string("13:56:24"), "[H]:[m]:[s]")` returns `13:56:24`
- `altova:parse-time("13-56-24", "[H]-[m]")` returns `13:56:00`
- `altova:parse-time("time=13h56m24s", "time=[H]h[m]m[s]s")` returns `13:56:24`
- `altova:parse-time("time=24s56m13h", "time=[s]s[m]m[H]h")` returns `13:56:24`

[[Top](#)¹⁵⁵⁷]

Age-related functions [XP3.1](#) [XQ3.1](#)

These functions return the age as calculated (i) between one input argument date and the current date, or (ii) between two input argument dates. The `altova:age` function returns the age in terms of years, the `altova:age-details` function returns the age as a sequence of three integers giving the years, months, and days of the age.

▼ age [altova:]

`altova:age(StartDate as xs:date) as xs:integer` [XP3.1](#) [XQ3.1](#)

Returns an integer that is the age *in years* of some object, counting from a start-date submitted as the argument and ending with the current date (taken from the system clock). If the input argument is a date anything greater than or equal to one year in the future, the return value will be negative.

Examples

If the current date is 2014-01-15:

- `altova:age(xs:date("2013-01-15"))` returns 1
- `altova:age(xs:date("2013-01-16"))` returns 0
- `altova:age(xs:date("2015-01-15"))` returns -1
- `altova:age(xs:date("2015-01-14"))` returns 0

`altova:age(StartDate as xs:date, EndDate as xs:date) as xs:integer XP3.1 XQ3.1`

Returns an integer that is the age *in years* of some object, counting from a start-date that is submitted as the first argument up to an end-date that is the second argument. The return value will be negative if the first argument is one year or more later than the second argument.

▣ Examples

If the current date is 2014-01-15:

- `altova:age(xs:date("2000-01-15"), xs:date("2010-01-15"))` returns 10
- `altova:age(xs:date("2000-01-15"), current-date())` returns 14 if the current date is 2014-01-15
- `altova:age(xs:date("2014-01-15"), xs:date("2010-01-15"))` returns -4

▼ age-details [altova:]

`altova:age-details(InputDate as xs:date) as (xs:integer)* XP3.1 XQ3.1`

Returns three integers that are, respectively, the years, months, and days between the date that is submitted as the argument and the current date (taken from the system clock). The sum of the returned `years+months+days` together gives the total time difference between the two dates (the input date and the current date). The input date may have a value earlier or later than the current date, but whether the input date is earlier or later is not indicated by the sign of the return values; the return values are always positive.

▣ Examples

If the current date is 2014-01-15:

- `altova:age-details(xs:date("2014-01-16"))` returns (0 0 1)
- `altova:age-details(xs:date("2014-01-14"))` returns (0 0 1)
- `altova:age-details(xs:date("2013-01-16"))` returns (1 0 1)
- `altova:age-details(current-date())` returns (0 0 0)

`altova:age-details(Date-1 as xs:date, Date-2 as xs:date) as (xs:integer)* XP3.1 XQ3.1`

Returns three integers that are, respectively, the years, months, and days between the two argument dates. The sum of the returned `years+months+days` together gives the total time difference between the two input dates; it does not matter whether the earlier or later of the two dates is submitted as the first argument. The return values do not indicate whether the input date occurs earlier or later than the current date. Return values are always positive.

▣ Examples

- `altova:age-details(xs:date("2014-01-16"), xs:date("2014-01-15"))` returns (0 0 1)
- `altova:age-details(xs:date("2014-01-15"), xs:date("2014-01-16"))` returns (0 0 1)

Epoch time (Unix time) functions [XP3.1](#) [XQ3.1](#)

Epoch time is a time system used on Unix systems. It defines any given point in time as being the number of seconds that have elapsed since 00:00:00 UTC on 1 January 1970. Altova's Epoch time extension functions convert `xs:dateTime` values to Epoch time values and vice versa.

▼ `dateTime-from-epoch` [altova:]

`altova:dateTime-from-epoch` (Epoch as `xs:decimal` as `xs:dateTime` [XP3.1](#) [XQ3.1](#))

Epoch time is a time system used on Unix systems. It defines any given point in time as being the number of seconds that have elapsed since 00:00:00 UTC on 1 January 1970. The `dateTime-from-epoch` function returns the `xs:dateTime` equivalent of an Epoch time, adjusts it for the local timezone, and includes the timezone information in the result.

The function takes an `xs:decimal` argument and returns an `xs:dateTime` value that includes a `tz` (timezone) part. The result is obtained by calculating the UTC `dateTime` equivalent of the Epoch time, and adding to it the local timezone (taken from the system clock). For example, if the function is executed on a machine that has been set to be in a timezone of +01:00 (relative to UTC), then after the UTC `dateTime` equivalent has been calculated, one hour will be added to the result. The timezone information, which is an optional lexical part of the `xs:dateTime` result, is also reported in the `dateTime` result. Compare this result with that of `dateTime-from-epoch-no-TZ`, and also see the function `epoch-from-dateTime`.

▣ Examples

The examples below assume a local timezone of UTC +01:00. Consequently, the UTC `dateTime` equivalent of the submitted Epoch time will be incremented by one hour. The timezone is reported in the result.

- `altova:dateTime-from-epoch` (34) returns `1970-01-01T01:00:34+01:00`
- `altova:dateTime-from-epoch` (62) returns `1970-01-01T01:01:02+01:00`

▼ `dateTime-from-epoch-no-TZ` [altova:]

`altova:dateTime-from-epoch-no-TZ` (Epoch as `xs:decimal` as `xs:dateTime` [XP3.1](#) [XQ3.1](#))

Epoch time is a time system used on Unix systems. It defines any given point in time as being the number of seconds that have elapsed since 00:00:00 UTC on 1 January 1970. The `dateTime-from-epoch-no-TZ` function returns the `xs:dateTime` equivalent of an Epoch time, adjusts it for the local timezone, but does not include the timezone information in the result.

The function takes an `xs:decimal` argument and returns an `xs:dateTime` value that does not include a `tz` (timezone) part. The result is obtained by calculating the UTC `dateTime` equivalent of the Epoch time, and adding to it the local timezone (taken from the system clock). For example, if the function is executed on a machine that has been set to be in a timezone of +01:00 (relative to UTC), then after the UTC `dateTime` equivalent has been calculated, one hour will be added to the result. The timezone information, which is an optional lexical part of the `xs:dateTime` result, is not reported in the `dateTime` result. Compare this result with that of `dateTime-from-epoch`, and also see the function `epoch-from-dateTime`.

▣ Examples

The examples below assume a local timezone of UTC +01:00. Consequently, the UTC `dateTime`

equivalent of the submitted Epoch time will be incremented by one hour. The timezone is not reported in the result.

- `altova:dateTime-from-epoch` (34) returns `1970-01-01T01:00:34`
- `altova:dateTime-from-epoch` (62) returns `1970-01-01T01:01:02`

▼ epoch-from-dateTime [altova:]

`altova:epoch-from-dateTime` (`dateTimeValue` as `xs:dateTime`) as `xs:decimal` **XP3.1 XQ3.1**

Epoch time is a time system used on Unix systems. It defines any given point in time as being the number of seconds that have elapsed since 00:00:00 UTC on 1 January 1970. The `epoch-from-dateTime` function returns the Epoch time equivalent of the `xs:dateTime` that is submitted as the argument of the function. Note that you might have to explicitly construct the `xs:dateTime` value. The submitted `xs:dateTime` value may or may not contain the optional `Tz` (timezone) part.

Whether the timezone part is submitted as part of the argument or not, the local timezone offset (taken from the system clock) is subtracted from the submitted `dateTimeValue` argument. This produces the equivalent UTC time, from which the equivalent Epoch time is calculated. For example, if the function is executed on a machine that has been set to be in a timezone of +01:00 (relative to UTC), then one hour is subtracted from the submitted `dateTimeValue` before the Epoch value is calculated. Also see the function `dateTime-from-epoch`.

▣ Examples

The examples below assume a local timezone of UTC +01:00. Consequently, one hour will be subtracted from the submitted `dateTime` before the Epoch time is calculated.

- `altova:epoch-from-dateTime` (`xs:dateTime("1970-01-01T01:00:34+01:00")`) returns `34`
- `altova:epoch-from-dateTime` (`xs:dateTime("1970-01-01T01:00:34")`) returns `34`
- `altova:epoch-from-dateTime` (`xs:dateTime("2021-04-01T11:22:33")`) returns `1617272553`

[[Top](#) ¹⁵⁵⁷]

27.2.1.3 XPath/XQuery Functions: Geolocation

The following geolocation XPath/XQuery extension functions are supported in the current version of XMLSpy and can be used in (i) XPath expressions in an XSLT context, or (ii) XQuery expressions in an XQuery document.

Note about naming of functions and language applicability

Altova extension functions can be used in XPath/XQuery expressions. They provide additional functionality to the functionality that is available in the standard library of XPath, XQuery, and XSLT functions. Altova extension functions are in the **Altova extension functions namespace**, <http://www.altova.com/xslt-extensions>, and are indicated in this section with the prefix `altova:`, which is assumed to be bound to this namespace. Note that, in future versions of your product, support for a function might be discontinued or the behavior of individual functions might change. Consult the documentation of future releases for information about support for Altova extension functions in that release.

| | |
|---|--------------------------|
| <i>XPath functions (used in XPath expressions in XSLT):</i> | XP1 XP2 XP3.1 |
| <i>XSLT functions (used in XPath expressions in XSLT):</i> | XSLT1 XSLT2 XSLT3 |
| <i>XQuery functions (used in XQuery expressions in XQuery):</i> | XQ1 XQ3.1 |

▼ format-geolocation [altova:]

altova:format-geolocation(Latitude as xs:decimal, Longitude as xs:decimal, GeolocationOutputStringFormat as xs:integer) as xs:string **XP3.1 XQ3.1**

Takes the latitude and longitude as the first two arguments, and outputs the geolocation as a string. The third argument, **GeolocationOutputStringFormat**, is the format of the geolocation output string; it uses integer values from 1 to 4 to identify the output string format (see 'Geolocation output string formats' below). Latitude values range from +90 to -90 (N to S). Longitude values range from +180 to -180 (E to W).

Note: The [image-exif-data](#)¹⁵⁸⁶ function and the Exif metadata's attributes can be used to supply the input strings.

☐ Examples

- **altova:format-geolocation**(33.33, -22.22, 4) returns the xs:string "33.33 -22.22"
- **altova:format-geolocation**(33.33, -22.22, 2) returns the xs:string "33.33N 22.22W"
- **altova:format-geolocation**(-33.33, 22.22, 2) returns the xs:string "33.33S 22.22E"
- **altova:format-geolocation**(33.33, -22.22, 1) returns the xs:string "33°19'48.00"S 22°13'12.00"E"

☐ Geolocation output string formats:

The supplied latitude and longitude is formatted in one of the output formats given below. The desired format is identified by its integer ID (1 to 4). Latitude values range from +90 to -90 (N to S). Longitude values range from +180 to -180 (E to W).

| |
|---|
| 1 |
| Degrees, minutes, decimal seconds, with suffixed orientation (N/S, E/W)
D°M'S.SS"N/S D°M'S.SS"E/W
<u>Example:</u> 33°55'11.11"N 22°44'66.66"W |

| |
|---|
| 2 |
| Decimal degrees, with suffixed orientation (N/S, E/W)
D.DDN/S D.DDE/W
<u>Example:</u> 33.33N 22.22W |

| |
|---|
| 3 |
| Degrees, minutes, decimal seconds, with prefixed sign (+/-); plus sign for (N/E) is optional
+/-D°M'S.SS" +/-D°M'S.SS"
<u>Example:</u> 33°55'11.11" -22°44'66.66" |

| |
|--|
| 4 |
| <p>Decimal degrees, with prefixed sign (+/-); plus sign for (N/E) is optional</p> <p>+/-D.DD +/-D.DD</p> <p><i>Example:</i> 33.33 -22.22</p> |

Altova Exif Attribute: Geolocation

The Altova XPath/XQuery Engine generates the custom attribute `Geolocation` from standard Exif metadata tags. `Geolocation` is a concatenation of four Exif tags: `GPSLatitude`, `GPSLatitudeRef`, `GPSLongitude`, `GPSLongitudeRef`, with units added (see table below).

| GPSLatitude | GPSLatitudeRef | GPSLongitude | GPSLongitudeRef | Geolocation |
|-------------|----------------|--------------|-----------------|------------------------------|
| 33 51 21.91 | S | 151 13 11.73 | E | 33°51'21.91"S 151°13'11.73"E |

▼ parse-geolocation [altova:]

`altova:parse-geolocation(GeolocationInputString as xs:string) as xs:decimal+ XP3.1 XQ3.1`
 Parses the supplied `GeolocationInputString` argument and returns the geolocation's latitude and longitude (in that order) as a sequence two `xs:decimal` items. The formats in which the geolocation input string can be supplied are listed below.

Note: The [image-exif-data](#)¹⁵⁸⁶ function and the Exif metadata's `@Geolocation`¹⁵⁸⁶ attribute can be used to supply the geolocation input string (see example below).

Examples

- `altova:parse-geolocation("33.33 -22.22")` returns the sequence of two `xs:decimals` (33.33, 22.22)
- `altova:parse-geolocation("48°51'29.6"N 24°17'40.2"W")` returns the sequence of two `xs:decimals` (48.858222222222, 24.2945)
- `altova:parse-geolocation("48°51'29.6"N 24°17'40.2"W")` returns the sequence of two `xs:decimals` (48.858222222222, 24.2945)
- `altova:parse-geolocation(image-exif-data(//MyImages/Image20141130.01)/@Geolocation)` returns a sequence of two `xs:decimals`

Geolocation input string formats:

The geolocation input string must contain latitude and longitude (in that order) separated by whitespace. Each can be in any of the following formats. Combinations are allowed. So latitude can be in one format and longitude can be in another. Latitude values range from +90 to -90 (N to S). Longitude values range from +180 to -180 (E to W).

Note: If single quotes or double quotes are used to delimit the input string argument, this will create

a mismatch with the single quotes or double quotes that are used, respectively, to indicate minute-values and second-values. In such cases, the quotes that are used for indicating minute-values and second-values must be escaped by doubling them. In the examples in this section, quotes used to delimit the input string are highlighted in yellow (") while unit indicators that are escaped are highlighted in blue (").

- Degrees, minutes, decimal seconds, with suffixed orientation (N/S, E/W)
`D°M'S.SS"N/S D°M'S.SS"W/E`
Example: 33°55'11.11"N 22°44'55.25"W
- Degrees, minutes, decimal seconds, with prefixed sign (+/-); the plus sign for (N/E) is optional
`+/-D°M'S.SS" +/-D°M'S.SS"`
Example: 33°55'11.11" -22°44'55.25"
- Degrees, decimal minutes, with suffixed orientation (N/S, E/W)
`D°M.MM'N/S D°M.MM'W/E`
Example: 33°55.55'N 22°44.44'W
- Degrees, decimal minutes, with prefixed sign (+/-); the plus sign for (N/E) is optional
`+/-D°M.MM' +/-D°M.MM'`
Example: +33°55.55' -22°44.44'
- Decimal degrees, with suffixed orientation (N/S, E/W)
`D.DDN/S D.DDW/E`
Example: 33.33N 22.22W
- Decimal degrees, with prefixed sign (+/-); the plus sign for (N/S E/W) is optional
`+/-D.DD +/-D.DD`
Example: 33.33 -22.22

Examples of format-combinations:

33.33N -22°44'55.25"
 33.33 22°44'55.25"W
 33.33 22.45

☐ Altova Exif Attribute: Geolocation

The Altova XPath/XQuery Engine generates the custom attribute `Geolocation` from standard Exif metadata tags. `Geolocation` is a concatenation of four Exif tags: `GPSLatitude`, `GPSLatitudeRef`, `GPSLongitude`, `GPSLongitudeRef`, with units added (see table below).

| GPSLatitude | GPSLatitudeRef | GPSLongitude | GPSLongitudeRef | Geolocation |
|-------------|----------------|--------------|-----------------|------------------------------|
| 33 51 21.91 | S | 151 13 11.73 | E | 33°51'21.91"S 151°13'11.73"E |

▼ geolocation-distance-km [altova:]

`altova:geolocation-distance-km`(`GeolocationInputString-1` as `xs:string`,
`GeolocationInputString-2` as `xs:string`) as `xs:decimal` **XP3.1 XQ3.1**

Calculates the distance between two geolocations in kilometers. The formats in which the geolocation input string can be supplied are listed below. Latitude values range from +90 to -90 (N to S). Longitude values range from +180 to -180 (E to W).

Note: The [image-exif-data](#)¹⁵⁸⁶ function and the Exif metadata's [@Geolocation](#)¹⁵⁸⁶ attribute can be used to supply geolocation input strings.

Examples

- `altova:geolocation-distance-km`("33.33 -22.22", "48°51'29.6"N 24°17'40.2"W") returns the `xs:decimal` 4183.08132372392

Geolocation input string formats:

The geolocation input string must contain latitude and longitude (in that order) separated by whitespace. Each can be in any of the following formats. Combinations are allowed. So latitude can be in one format and longitude can be in another. Latitude values range from +90 to -90 (N to S). Longitude values range from +180 to -180 (E to W).

Note: If single quotes or double quotes are used to delimit the input string argument, this will create a mismatch with the single quotes or double quotes that are used, respectively, to indicate minute-values and second-values. In such cases, the quotes that are used for indicating minute-values and second-values must be escaped by doubling them. In the examples in this section, quotes used to delimit the input string are highlighted in yellow (") while unit indicators that are escaped are highlighted in blue ("").

- Degrees, minutes, decimal seconds, with suffixed orientation (N/S, E/W)
`D°M'S.SS"N/S` `D°M'S.SS"W/E`
Example: 33°55'11.11"N 22°44'55.25"W
- Degrees, minutes, decimal seconds, with prefixed sign (+/-); the plus sign for (N/E) is optional
`+/-D°M'S.SS"` `+/-D°M'S.SS"`
Example: 33°55'11.11" -22°44'55.25"
- Degrees, decimal minutes, with suffixed orientation (N/S, E/W)
`D°M.MM'N/S` `D°M.MM'W/E`
Example: 33°55.55'N 22°44.44'W
- Degrees, decimal minutes, with prefixed sign (+/-); the plus sign for (N/E) is optional
`+/-D°M.MM'` `+/-D°M.MM'`
Example: +33°55.55' -22°44.44'
- Decimal degrees, with suffixed orientation (N/S, E/W)
`D.DDN/S` `D.DDW/E`
Example: 33.33N 22.22W
- Decimal degrees, with prefixed sign (+/-); the plus sign for (N/S E/W) is optional
`+/-D.DD` `+/-D.DD`
Example: 33.33 -22.22

Examples of format-combinations:

33.33N -22°44'55.25"
 33.33 22°44'55.25"W
 33.33 22.45

☐ Altova Exif Attribute: Geolocation

The Altova XPath/XQuery Engine generates the custom attribute `Geolocation` from standard Exif metadata tags. `Geolocation` is a concatenation of four Exif tags: `GPSLatitude`, `GPSLatitudeRef`, `GPSLongitude`, `GPSLongitudeRef`, with units added (see table below).

| GPSLatitude | GPSLatitudeRef | GPSLongitude | GPSLongitudeRef | Geolocation |
|-------------|----------------|--------------|-----------------|------------------------------|
| 33 51 21.91 | S | 151 13 11.73 | E | 33°51'21.91"S 151°13'11.73"E |

▼ geolocation-distance-mi [altova:]

`altova:geolocation-distance-mi (GeolocationInputString-1 as xs:string, GeolocationInputString-2 as xs:string) as xs:decimal XP3.1 XQ3.1`

Calculates the distance between two geolocations in miles. The formats in which a geolocation input string can be supplied are listed below. Latitude values range from +90 to -90 (N to S). Longitude values range from +180 to -180 (E to W).

Note: The [image-exif-data](#)¹⁵⁸⁶ function and the Exif metadata's `@Geolocation`¹⁵⁸⁶ attribute can be used to supply geolocation input strings.

☐ Examples

- `altova:geolocation-distance-mi ("33.33 -22.22", "48°51'29.6"N 24°17'40.2"W")` returns the `xs:decimal 2599.40652340653`

☐ Geolocation input string formats:

The geolocation input string must contain latitude and longitude (in that order) separated by whitespace. Each can be in any of the following formats. Combinations are allowed. So latitude can be in one format and longitude can be in another. Latitude values range from +90 to -90 (N to S). Longitude values range from +180 to -180 (E to W).

Note: If single quotes or double quotes are used to delimit the input string argument, this will create a mismatch with the single quotes or double quotes that are used, respectively, to indicate minute-values and second-values. In such cases, the quotes that are used for indicating minute-values and second-values must be escaped by doubling them. In the examples in this section, quotes used to delimit the input string are highlighted in yellow (") while unit indicators that are escaped are highlighted in blue (").

- Degrees, minutes, decimal seconds, with suffixed orientation (N/S, E/W)
`D°M'S.SS"N/S D°M'S.SS"W/E`

Example: 33°55'11.11"N 22°44'55.25"W

- Degrees, minutes, decimal seconds, with prefixed sign (+/-); the plus sign for (N/E) is optional

`+/-D°M'S.SS" +/-D°M'S.SS"`

Example: 33°55'11.11" -22°44'55.25"

- Degrees, decimal minutes, with suffixed orientation (N/S, E/W)

`D°M.MM'N/S D°M.MM'W/E`

Example: 33°55.55'N 22°44.44'W

- Degrees, decimal minutes, with prefixed sign (+/-); the plus sign for (N/E) is optional

`+/-D°M.MM' +/-D°M.MM'`

Example: +33°55.55' -22°44.44'

- Decimal degrees, with suffixed orientation (N/S, E/W)

`D.DDN/S D.DDW/E`

Example: 33.33N 22.22W

- Decimal degrees, with prefixed sign (+/-); the plus sign for (N/S E/W) is optional

`+/-D.DD +/-D.DD`

Example: 33.33 -22.22

Examples of format-combinations:

33.33N -22°44'55.25"

33.33 22°44'55.25"W

33.33 22.45

☐ Altova Exif Attribute: Geolocation

The Altova XPath/XQuery Engine generates the custom attribute **Geolocation** from standard Exif metadata tags. **Geolocation** is a concatenation of four Exif tags: **GPSLatitude**, **GPSLatitudeRef**, **GPSLongitude**, **GPSLongitudeRef**, with units added (see *table below*).

| GPSLatitude | GPSLatitudeRef | GPSLongitude | GPSLongitudeRef | Geolocation |
|-------------|----------------|--------------|-----------------|------------------------------|
| 33 51 21.91 | S | 151 13 11.73 | E | 33°51'21.91"S 151°13'11.73"E |

▼ geolocations-bounding-rectangle [altova:]

altova:geolocations-bounding-rectangle (**Geolocations** as *xs:sequence*, **GeolocationOutputStringFormat** as *xs:integer*) as *xs:string* **XP3.1 XQ3.1**

Takes a sequence of strings as its first argument; each string in the sequence is a geolocation. The function returns a sequence of two strings which are, respectively, the top-left and bottom-right geolocation coordinates of a bounding rectangle that is optimally sized to enclose all the geolocations submitted in the first argument. The formats in which a geolocation input string can be supplied are listed below (see '*Geolocation input string formats*'). Latitude values range from +90 to -90 (N to S). Longitude values range

from +180 to -180 (E to W).

The function's second argument specifies the format of the two geolocation strings in the output sequence. The argument takes an integer value from 1 to 4, where each value identifies a different geolocation string format (see 'Geolocation output string formats' below).

Note: The [image-exif-data](#)¹⁵⁸⁶ function and the Exif metadata's attributes can be used to supply the input strings.

Examples

- `altova:geolocations-bounding-rectangle`("48.2143531 16.3707266", "51.50939 - 0.11832"), 1) returns the sequence ("51°30'33.804"N 0°7'5.952"W", "48°12'51.67116"N 16°22'14.61576"E")
- `altova:geolocations-bounding-rectangle`("48.2143531 16.3707266", "51.50939 - 0.11832", "42.5584577 -70.8893334"), 4) returns the sequence ("51.50939 -70.8893334", "42.5584577 16.3707266")

Geolocation input string formats:

The geolocation input string must contain latitude and longitude (in that order) separated by whitespace. Each can be in any of the following formats. Combinations are allowed. So latitude can be in one format and longitude can be in another. Latitude values range from +90 to -90 (N to S). Longitude values range from +180 to -180 (E to W).

Note: If single quotes or double quotes are used to delimit the input string argument, this will create a mismatch with the single quotes or double quotes that are used, respectively, to indicate minute-values and second-values. In such cases, the quotes that are used for indicating minute-values and second-values must be escaped by doubling them. In the examples in this section, quotes used to delimit the input string are highlighted in yellow (") while unit indicators that are escaped are highlighted in blue (").

- Degrees, minutes, decimal seconds, with suffixed orientation (N/S, E/W)
D°M'S.SS"N/S D°M'S.SS"W/E
Example: 33°55'11.11"N 22°44'55.25"W
- Degrees, minutes, decimal seconds, with prefixed sign (+/-); the plus sign for (N/E) is optional
+/-D°M'S.SS" +/-D°M'S.SS"
Example: 33°55'11.11" -22°44'55.25"
- Degrees, decimal minutes, with suffixed orientation (N/S, E/W)
D°M.MM'N/S D°M.MM'W/E
Example: 33°55.55'N 22°44.44'W
- Degrees, decimal minutes, with prefixed sign (+/-); the plus sign for (N/E) is optional
+/-D°M.MM' +/-D°M.MM'
Example: +33°55.55' -22°44.44'
- Decimal degrees, with suffixed orientation (N/S, E/W)
D.DDN/S D.DDW/E
Example: 33.33N 22.22W

- Decimal degrees, with prefixed sign (+/-); the plus sign for (N/S E/W) is optional
`+/-D.DD +/-D.DD`
Example: 33.33 -22.22

Examples of format-combinations:

33.33N -22°44'55.25"
 33.33 22°44'55.25"W
 33.33 22.45

☐ Geolocation output string formats:

The supplied latitude and longitude is formatted in one of the output formats given below. The desired format is identified by its integer ID (1 to 4). Latitude values range from +90 to -90 (N to S). Longitude values range from +180 to -180 (E to W).

| |
|--|
| 1 |
| Degrees, minutes, decimal seconds, with suffixed orientation (N/S, E/W)
<code>D°M'S.SS"N/S D°M'S.SS"E/W</code>
<i>Example:</i> 33°55'11.11"N 22°44'66.66"W |

| |
|--|
| 2 |
| Decimal degrees, with suffixed orientation (N/S, E/W)
<code>D.DDN/S D.DDE/W</code>
<i>Example:</i> 33.33N 22.22W |

| |
|--|
| 3 |
| Degrees, minutes, decimal seconds, with prefixed sign (+/-); plus sign for (N/E) is optional
<code>+/-D°M'S.SS" +/-D°M'S.SS"</code>
<i>Example:</i> 33°55'11.11" -22°44'66.66" |

| |
|--|
| 4 |
| Decimal degrees, with prefixed sign (+/-); plus sign for (N/E) is optional
<code>+/-D.DD +/-D.DD</code>
<i>Example:</i> 33.33 -22.22 |

☐ Altova Exif Attribute: Geolocation

The Altova XPath/XQuery Engine generates the custom attribute `Geolocation` from standard Exif metadata tags. `Geolocation` is a concatenation of four Exif tags: `GPSLatitude`, `GPSLatitudeRef`, `GPSLongitude`, `GPSLongitudeRef`, with units added (see table below).

| GPSLatitude | GPSLatitudeRef | GPSLongitude | GPSLongitudeRef | Geolocation |
|-------------|----------------|--------------|-----------------|------------------------------|
| 33 51 21.91 | S | 151 13 11.73 | E | 33°51'21.91"S 151°13'11.73"E |

▼ geolocation-within-polygon [altova:]

`altova:geolocation-within-polygon(Geolocation as xs:string, ((PolygonPoint as xs:string)+)) as xs:boolean XP3.1 XQ3.1`

Determines whether `Geolocation` (the first argument) is within the polygonal area described by the `PolygonPoint` arguments. If the `PolygonPoint` arguments do not form a closed figure (formed when the first point and the last point are the same), then the first point is implicitly added as the last point in order to close the figure. All the arguments (`Geolocation` and `PolygonPoint+`) are given by geolocation input strings (*formats listed below*). If the `Geolocation` argument is within the polygonal area, then the function returns `true()`; otherwise it returns `false()`. Latitude values range from +90 to -90 (N to S). Longitude values range from +180 to -180 (E to W).

Note: The [image-exif-data](#)¹⁵⁸⁶ function and the Exif metadata's [@Geolocation](#)¹⁵⁸⁶ attribute can be used to supply geolocation input strings.

▣ Examples

- `altova:geolocation-within-polygon("33 -22", ("58 -32", "-78 -55", "48 24", "58 -32"))` returns `true()`
- `altova:geolocation-within-polygon("33 -22", ("58 -32", "-78 -55", "48 24"))` returns `true()`
- `altova:geolocation-within-polygon("33 -22", ("58 -32", "-78 -55", "48°51'29.6"N 24°17'40.2"W"))` returns `true()`

▣ Geolocation input string formats:

The geolocation input string must contain latitude and longitude (in that order) separated by whitespace. Each can be in any of the following formats. Combinations are allowed. So latitude can be in one format and longitude can be in another. Latitude values range from +90 to -90 (N to S). Longitude values range from +180 to -180 (E to W).

Note: If single quotes or double quotes are used to delimit the input string argument, this will create a mismatch with the single quotes or double quotes that are used, respectively, to indicate minute-values and second-values. In such cases, the quotes that are used for indicating minute-values and second-values must be escaped by doubling them. In the examples in this section, quotes used to delimit the input string are highlighted in yellow (") while unit indicators that are escaped are highlighted in blue (").

- Degrees, minutes, decimal seconds, with suffixed orientation (N/S, E/W)
`D°M'S.SS"N/S D°M'S.SS"W/E`
Example: `33°55'11.11"N 22°44'55.25"W`
- Degrees, minutes, decimal seconds, with prefixed sign (+/-); the plus sign for (N/E) is optional
`+/-D°M'S.SS" +/-D°M'S.SS"`
Example: `33°55'11.11" -22°44'55.25"`

- Degrees, decimal minutes, with suffixed orientation (N/S, E/W)
 $D^{\circ}M.MM'N/S$ $D^{\circ}M.MM'W/E$
Example: 33°55.55'N 22°44.44'W
- Degrees, decimal minutes, with prefixed sign (+/-); the plus sign for (N/E) is optional
 $+/-D^{\circ}M.MM'$ $+/-D^{\circ}M.MM'$
Example: +33°55.55' -22°44.44'
- Decimal degrees, with suffixed orientation (N/S, E/W)
 $D.DDN/S$ $D.DDW/E$
Example: 33.33N 22.22W
- Decimal degrees, with prefixed sign (+/-); the plus sign for (N/S E/W) is optional
 $+/-D.DD$ $+/-D.DD$
Example: 33.33 -22.22

Examples of format-combinations:

33.33N -22°44'55.25"
 33.33 22°44'55.25"W
 33.33 22.45

▣ *Altova Exif Attribute: Geolocation*

The Altova XPath/XQuery Engine generates the custom attribute `Geolocation` from standard Exif metadata tags. `Geolocation` is a concatenation of four Exif tags: `GPSLatitude`, `GPSLatitudeRef`, `GPSLongitude`, `GPSLongitudeRef`, with units added (see table below).

| GPSLatitude | GPSLatitudeRef | GPSLongitude | GPSLongitudeRef | Geolocation |
|-------------|----------------|--------------|-----------------|------------------------------|
| 33 51 21.91 | S | 151 13 11.73 | E | 33°51'21.91"S 151°13'11.73"E |

▼ `geolocation-within-rectangle` [altova:]

`altova:geolocation-within-rectangle(Geolocation as xs:string, RectCorner-1 as xs:string, RectCorner-2 as xs:string) as xs:boolean XP3.1 XQ3.1`

Determines whether `Geolocation` (the first argument) is within the rectangle defined by the second and third arguments, `RectCorner-1` and `RectCorner-2`, which specify opposite corners of the rectangle. All the arguments (`Geolocation`, `RectCorner-1` and `RectCorner-2`) are given by geolocation input strings (formats listed below). If the `Geolocation` argument is within the rectangle, then the function returns `true()`; otherwise it returns `false()`. Latitude values range from +90 to -90 (N to S). Longitude values range from +180 to -180 (E to W).

Note: The [image-exif-data](#)¹⁵⁸⁶ function and the Exif metadata's [@Geolocation](#)¹⁵⁸⁶ attribute can be used to supply geolocation input strings.

▣ *Examples*

- `altova:geolocation-within-rectangle("33 -22", "58 -32", "-48 24")` returns `true()`

- `altova:geolocation-within-rectangle("33 -22", "58 -32", "48 24")` returns `false()`
- `altova:geolocation-within-rectangle("33 -22", "58 -32", "48°51'29.6"S 24°17'40.2"W")` returns `true()`

☐ Geolocation input string formats:

The geolocation input string must contain latitude and longitude (in that order) separated by whitespace. Each can be in any of the following formats. Combinations are allowed. So latitude can be in one format and longitude can be in another. Latitude values range from +90 to -90 (N to S). Longitude values range from +180 to -180 (E to W).

Note: If single quotes or double quotes are used to delimit the input string argument, this will create a mismatch with the single quotes or double quotes that are used, respectively, to indicate minute-values and second-values. In such cases, the quotes that are used for indicating minute-values and second-values must be escaped by doubling them. In the examples in this section, quotes used to delimit the input string are highlighted in yellow (") while unit indicators that are escaped are highlighted in blue (").

- Degrees, minutes, decimal seconds, with suffixed orientation (N/S, E/W)
`D°M'S.SS"N/S` `D°M'S.SS"W/E`
Example: `33°55'11.11"N` `22°44'55.25"W`
- Degrees, minutes, decimal seconds, with prefixed sign (+/-); the plus sign for (N/E) is optional
`+/-D°M'S.SS"` `+/-D°M'S.SS"`
Example: `33°55'11.11"` `-22°44'55.25"`
- Degrees, decimal minutes, with suffixed orientation (N/S, E/W)
`D°M.MM'N/S` `D°M.MM'W/E`
Example: `33°55.55'N` `22°44.44'W`
- Degrees, decimal minutes, with prefixed sign (+/-); the plus sign for (N/E) is optional
`+/-D°M.MM'` `+/-D°M.MM'`
Example: `+33°55.55'` `-22°44.44'`
- Decimal degrees, with suffixed orientation (N/S, E/W)
`D.DDN/S` `D.DDW/E`
Example: `33.33N` `22.22W`
- Decimal degrees, with prefixed sign (+/-); the plus sign for (N/S E/W) is optional
`+/-D.DD` `+/-D.DD`
Example: `33.33` `-22.22`

Examples of format-combinations:

```
33.33N -22°44'55.25"
33.33 22°44'55.25"W
33.33 22.45
```

☐ Altova Exif Attribute: Geolocation

The Altova XPath/XQuery Engine generates the custom attribute `geolocation` from standard Exif metadata tags. `geolocation` is a concatenation of four Exif tags: `GPSLatitude`, `GPSLatitudeRef`,

GPSLongitude, GPSLongitudeRef, with units added (see table below).

| GPSLatitude | GPSLatitudeRef | GPSLongitude | GPSLongitudeRef | Geolocation |
|-------------|----------------|--------------|-----------------|------------------------------|
| 33 51 21.91 | S | 151 13 11.73 | E | 33°51'21.91"S 151°13'11.73"E |

[[Top](#)¹⁵⁷⁴]

27.2.1.4 XPath/XQuery Functions: Image-Related

The following image-related XPath/XQuery extension functions are supported in the current version of XMLSpy and can be used in (i) XPath expressions in an XSLT context, or (ii) XQuery expressions in an XQuery document.

Note about naming of functions and language applicability

Altova extension functions can be used in XPath/XQuery expressions. They provide additional functionality to the functionality that is available in the standard library of XPath, XQuery, and XSLT functions. Altova extension functions are in the **Altova extension functions namespace**, <http://www.altova.com/xslt-extensions>, and are indicated in this section with the prefix **altova:**, which is assumed to be bound to this namespace. Note that, in future versions of your product, support for a function might be discontinued or the behavior of individual functions might change. Consult the documentation of future releases for information about support for Altova extension functions in that release.

| | |
|---|--------------------------|
| <i>XPath functions (used in XPath expressions in XSLT):</i> | XP1 XP2 XP3.1 |
| <i>XSLT functions (used in XPath expressions in XSLT):</i> | XSLT1 XSLT2 XSLT3 |
| <i>XQuery functions (used in XQuery expressions in XQuery):</i> | XQ1 XQ3.1 |

▼ suggested-image-file-extension [altova:]

altova:suggested-image-file-extension(Base64String as string) as string? **XP3.1 XQ3.1**

Takes the Base64 encoding of an image file as its argument and returns the file extension of the image as recorded in the Base64-encoding of the image. The returned value is a suggestion based on the image type information available in the encoding. If this information is not available, then an empty string is returned. This function is useful if you wish to save a Base64 image as a file and wish to dynamically retrieve an appropriate file extension.

☐ Examples

- **altova:suggested-image-file-extension**(/MyImages/MobilePhone/Image20141130.01) returns 'jpg'
- **altova:suggested-image-file-extension**(\$XML1/Staff/Person/@photo) returns ''

In the examples above, the nodes supplied as the argument of the function are assumed to contain a Base64-encoded image. The first example retrieves `jpg` as the file's type and extension. In the second example, the submitted Base64 encoding does not provide usable file extension information.

▼ `image-exif-data` [altova:]

`altova:image-exif-data` (Base64BinaryString as string) as element? **XP3.1 XQ3.1**

Takes a Base64-encoded JPEG image as its argument and returns an element called `Exif` that contains the Exif metadata of the image. The Exif metadata is created as attribute-value pairs of the `Exif` element. The attribute names are the Exif data tags found in the Base64 encoding. The list of Exif-specification tags is given below. If a vendor-specific tag is present in the Exif data, this tag and its value will also be returned as an attribute-value pair. Additional to the standard Exif metadata tags (see *list below*), Altova-specific attribute-value pairs are also generated. These Altova Exif attributes are listed below.

▣ Examples

- To access any one attribute, use the function like this:
`image-exif-data` (//MyImages/Image20141130.01)/@GPSLatitude
`image-exif-data` (//MyImages/Image20141130.01)/@Geolocation
- To access all the attributes, use the function like this:
`image-exif-data` (//MyImages/Image20141130.01)/@*
- To access the names of all the attributes, use the following expression:
`for $i in image-exif-data` (//MyImages/Image20141130.01)/@* `return name` (\$i)
 This is useful to find out the names of the attributes returned by the function.

▣ Altova Exif Attribute: Geolocation

The Altova XPath/XQuery Engine generates the custom attribute `Geolocation` from standard Exif metadata tags. `Geolocation` is a concatenation of four Exif tags: `GPSLatitude`, `GPSLatitudeRef`, `GPSLongitude`, `GPSLongitudeRef`, with units added (see *table below*).

| GPSLatitude | GPSLatitudeRef | GPSLongitude | GPSLongitudeRef | Geolocation |
|-------------|----------------|--------------|-----------------|------------------------------|
| 33 51 21.91 | S | 151 13 11.73 | E | 33°51'21.91"S 151°13'11.73"E |

▣ Altova Exif Attribute: OrientationDegree

The Altova XPath/XQuery Engine generates the custom attribute `orientationDegree` from the Exif metadata tag `Orientation`.

`orientationDegree` translates the standard Exif tag `Orientation` from an integer value (1, 8, 3, or 6) to the respective degree values of each (0, 90, 180, 270), as shown in the figure below. Note that there are no translations of the `Orientation` values of 2, 4, 5, 7. (These orientations are obtained by flipping image 1 across its vertical center axis to get the image with a value of 2, and then rotating this image in 90-degree jumps clockwise to get the values of 7, 4, and 5, respectively).

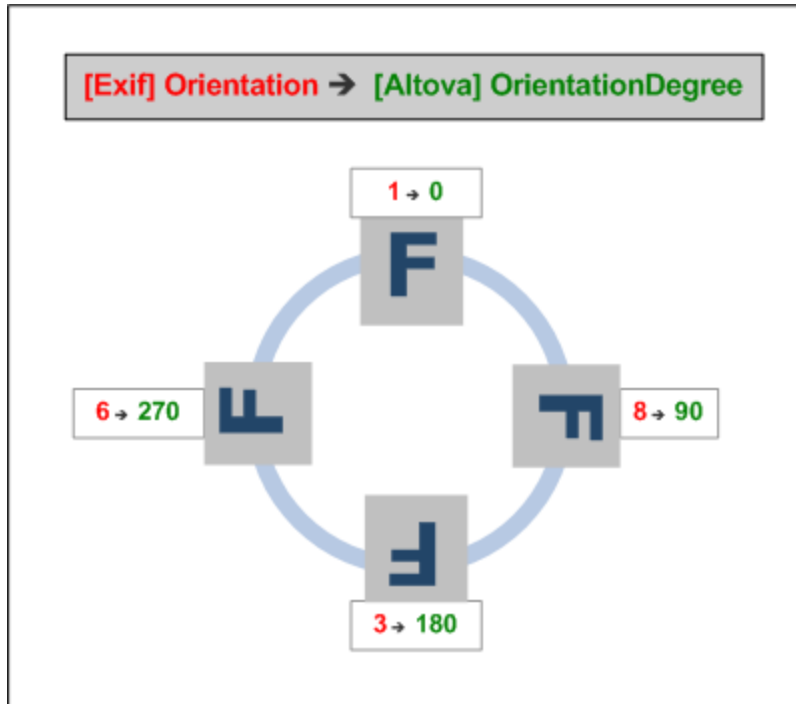

Listing of standard Exif meta tags

- ImageWidth
- ImageLength
- BitsPerSample
- Compression
- PhotometricInterpretation
- Orientation
- SamplesPerPixel
- PlanarConfiguration
- YCbCrSubSampling
- YCbCrPositioning
- XResolution
- YResolution
- ResolutionUnit
- StripOffsets
- RowsPerStrip
- StripByteCounts
- JPEGInterchangeFormat
- JPEGInterchangeFormatLength
- TransferFunction
- WhitePoint
- PrimaryChromaticities
- YCbCrCoefficients
- ReferenceBlackWhite
- DateTime
- ImageDescription
- Make

- Model
- Software
- Artist
- Copyright

-
- ExifVersion
 - FlashpixVersion
 - ColorSpace
 - ComponentsConfiguration
 - CompressedBitsPerPixel
 - PixelXDimension
 - PixelYDimension
 - MakerNote
 - UserComment
 - RelatedSoundFile
 - DateTimeOriginal
 - DateTimeDigitized
 - SubSecTime
 - SubSecTimeOriginal
 - SubSecTimeDigitized
 - ExposureTime
 - FNumber
 - ExposureProgram
 - SpectralSensitivity
 - ISOSpeedRatings
 - OECF
 - ShutterSpeedValue
 - ApertureValue
 - BrightnessValue
 - ExposureBiasValue
 - MaxApertureValue
 - SubjectDistance
 - MeteringMode
 - LightSource
 - Flash
 - FocalLength
 - SubjectArea
 - FlashEnergy
 - SpatialFrequencyResponse
 - FocalPlaneXResolution
 - FocalPlaneYResolution
 - FocalPlaneResolutionUnit
 - SubjectLocation
 - ExposureIndex
 - SensingMethod
 - FileSource
 - SceneType
 - CFAPattern
 - CustomRendered
 - ExposureMode
 - WhiteBalance
 - DigitalZoomRatio
 - FocalLengthIn35mmFilm
 - SceneCaptureType

- GainControl
 - Contrast
 - Saturation
 - Sharpness
 - DeviceSettingDescription
 - SubjectDistanceRange
 - ImageUniqueID
-

- GPSVersionID
- GPSLatitudeRef
- GPSLatitude
- GPSLongitudeRef
- GPSLongitude
- GPSAltitudeRef
- GPSAltitude
- GPSTimeStamp
- GPSSatellites
- GPSStatus
- GPSMeasureMode
- GPSDOP
- GPSSpeedRef
- GPSSpeed
- GPSTrackRef
- GPSTrack
- GPSImgDirectionRef
- GPSImgDirection
- GPSMapDatum
- GPSDestLatitudeRef
- GPSDestLatitude
- GPSDestLongitudeRef
- GPSDestLongitude
- GPSDestBearingRef
- GPSDestBearing
- GPSDestDistanceRef
- GPSDestDistance
- GPSProcessingMethod
- GPSAreaInformation
- GPSDateStamp
- GPSDifferential

[[Top](#)¹⁵⁸⁶]

27.2.1.5 XPath/XQuery Functions: Numeric

Altova's numeric extension functions can be used in XPath and XQuery expressions and provide additional functionality for the processing of data. The functions in this section can be used with Altova's **XPath 3.0** and **XQuery 3.0** engines. They are available in XPath/XQuery contexts.

Note about naming of functions and language applicability

Altova extension functions can be used in XPath/XQuery expressions. They provide additional functionality to the functionality that is available in the standard library of XPath, XQuery, and XSLT functions. Altova extension functions are in the **Altova extension functions namespace**, <http://www.altova.com/xslt-extensions>, and are indicated in this section with the prefix **altova:**, which is assumed to be bound to this namespace. Note that, in future versions of your product, support for a function might be discontinued or the behavior of individual functions might change. Consult the documentation of future releases for information about support for Altova extension functions in that release.

| | |
|---|--------------------------|
| <i>XPath functions (used in XPath expressions in XSLT):</i> | XP1 XP2 XP3.1 |
| <i>XSLT functions (used in XPath expressions in XSLT):</i> | XSLT1 XSLT2 XSLT3 |
| <i>XQuery functions (used in XQuery expressions in XQuery):</i> | XQ1 XQ3.1 |

Auto-numbering functions

▼ generate-auto-number [altova:]

altova:generate-auto-number(ID as xs:string, StartsWith as xs:double, Increment as xs:double, ResetOnChange as xs:string) **as xs:integer XP1 XP2 XQ1 XP3.1 XQ3.1**

Generates a number each time the function is called. The first number, which is generated the first time the function is called, is specified by the `StartsWith` argument. Each subsequent call to the function generates a new number, this number being incremented over the previously generated number by the value specified in the `Increment` argument. In effect, the `altova:generate-auto-number` function creates a counter having a name specified by the `ID` argument, with this counter being incremented each time the function is called. If the value of the `ResetOnChange` argument changes from that of the previous function call, then the value of the number to be generated is reset to the `StartsWith` value. Auto-numbering can also be reset by using the `altova:reset-auto-number` function.

☐ Examples

- **altova:generate-auto-number**("ChapterNumber", 1, 1, "SomeString") will return one number each time the function is called, starting with 1, and incrementing by 1 with each call to the function. As long as the fourth argument remains "SomeString" in each subsequent call, the incrementing will continue. When the value of the fourth argument changes, the counter (called `ChapterNumber`) will reset to 1. The value of `ChapterNumber` can also be reset by a call to the `altova:reset-auto-number` function, like this: `altova:reset-auto-number("ChapterNumber")`.

▼ reset-auto-number [altova:]

altova:reset-auto-number(ID as xs:string) **XP1 XP2 XQ1 XP3.1 XQ3.1**

This function resets the number of the auto-numbering counter named in the `ID` argument. The number is reset to the number specified by the `StartsWith` argument of the `altova:generate-auto-number` function that created the counter named in the `ID` argument.

☐ Examples

- **altova:reset-auto-number**("ChapterNumber") resets the number of the auto-numbering counter named `ChapterNumber` that was created by the `altova:generate-auto-number` function. The number is reset to the value of the `StartsWith` argument of the `altova:generate-auto-number` function that created `ChapterNumber`.

Numeric functions

▼ hex-string-to-integer [altova:]

`altova:hex-string-to-integer`(HexString as xs:string) as xs:integer **XP3.1 XQ3.1**

Takes a string argument that is the Base-16 equivalent of an integer in the decimal system (Base-10), and returns the decimal integer.

▣ Examples

- `altova:hex-string-to-integer('1')` returns 1
- `altova:hex-string-to-integer('9')` returns 9
- `altova:hex-string-to-integer('A')` returns 10
- `altova:hex-string-to-integer('B')` returns 11
- `altova:hex-string-to-integer('F')` returns 15
- `altova:hex-string-to-integer('G')` returns an error
- `altova:hex-string-to-integer('10')` returns 16
- `altova:hex-string-to-integer('01')` returns 1
- `altova:hex-string-to-integer('20')` returns 32
- `altova:hex-string-to-integer('21')` returns 33
- `altova:hex-string-to-integer('5A')` returns 90
- `altova:hex-string-to-integer('USA')` returns an error

▼ integer-to-hex-string [altova:]

`altova:integer-to-hex-string`(Integer as xs:integer) as xs:string **XP3.1 XQ3.1**

Takes an integer argument and returns its Base-16 equivalent as a string.

▣ Examples

- `altova:integer-to-hex-string(1)` returns '1'
- `altova:integer-to-hex-string(9)` returns '9'
- `altova:integer-to-hex-string(10)` returns 'A'
- `altova:integer-to-hex-string(11)` returns 'B'
- `altova:integer-to-hex-string(15)` returns 'F'
- `altova:integer-to-hex-string(16)` returns '10'
- `altova:integer-to-hex-string(32)` returns '20'
- `altova:integer-to-hex-string(33)` returns '21'
- `altova:integer-to-hex-string(90)` returns '5A'

Number-formatting functions

27.2.1.6 XPath/XQuery Functions: Schema

The Altova extension functions listed below return schema information. Given below are descriptions of the functions, together with (i) examples and (ii) a listing of schema components and their respective properties. They can be used with Altova's **XPath 3.0** and **XQuery 3.0** engines and are available in XPath/XQuery contexts.

Schema information from schema documents

The function `altova:schema` has two arguments: one with zero arguments and the other with two arguments. The zero-argument function returns the whole schema. You can then, from this starting point, navigate into the schema to locate the schema components you want. The two-argument function returns a specific component kind that is identified by its QName. In both cases, the return value is a function. To navigate into the returned component, you must select a property of that specific component. If the property is a non-atomic item (that is, if it is a component), then you can navigate further by selecting a property of this component. If the selected property is an atomic item, then the value of the item is returned and you cannot navigate any further.

Note: In XPath expressions, the schema must be imported into the processing environment (for example, into XSLT) with the `xslt:import-schema` instruction. In XQuery expressions, the schema must be explicitly imported using a `schema import`.

Schema information from XML nodes

The function `altova:type` submits the node of an XML document and returns the node's type information from the PSVI.

Note about naming of functions and language applicability

Altova extension functions can be used in XPath/XQuery expressions. They provide additional functionality to the functionality that is available in the standard library of XPath, XQuery, and XSLT functions. Altova extension functions are in the **Altova extension functions namespace**, `http://www.altova.com/xslt-extensions`, and are indicated in this section with the prefix `altova:`, which is assumed to be bound to this namespace. Note that, in future versions of your product, support for a function might be discontinued or the behavior of individual functions might change. Consult the documentation of future releases for information about support for Altova extension functions in that release.

| | |
|---|--------------------------------|
| <i>XPath functions (used in XPath expressions in XSLT):</i> | <code>XP1 XP2 XP3.1</code> |
| <i>XSLT functions (used in XPath expressions in XSLT):</i> | <code>XSLT1 XSLT2 XSLT3</code> |
| <i>XQuery functions (used in XQuery expressions in XQuery):</i> | <code>XQ1 XQ3.1</code> |

▼ Schema (zero arguments)

`altova:schema()` as `(function(xs:string) as item(*)?)` `XP3.1 XQ3.1`

Returns the `schema` component as a whole. You can navigate further into the `schema` component by selecting one of the `schema` component's properties.

- If this property is a component, you can navigate another step deeper by selecting one of this component's properties. This step can be repeated to navigate further into the schema.
- If the component is an atomic value, the atomic value is returned and you cannot navigate any deeper.

The properties of the `schema` component are:

```
"type definitions"
"attribute declarations"
"element declarations"
"attribute group definitions"
"model group definitions"
"notation declarations"
"identity-constraint definitions"
```

The properties of all other component kinds (besides `schema`) are listed below.

Note: In XQuery expressions, the schema must be explicitly imported. In XPath expressions, the schema must have been imported into the processing environment, for example, into XSLT with the `xslt:import` instruction.

Examples

- `import schema "" at "C:\Test\ExpReport.xsd"; for $typedef in altova:schema() ("type definitions") return $typedef ("name")` returns the names of all simple types or complex types in the schema
- `import schema "" at "C:\Test\ExpReport.xsd"; altova:schema() ("type definitions")[1] ("name")` returns the name of the first of all simple types or complex types in the schema

Components and their properties

Assertion

| Property name | Property type | Property value |
|---------------|-----------------------|----------------|
| kind | string | "Assertion" |
| test | XPath Property Record | |

Attribute Declaration

| Property name | Property type | Property value |
|------------------|---|--------------------------------|
| kind | string | "Attribute Declaration" |
| name | string | Local name of the attribute |
| target namespace | string | Namespace URI of the attribute |
| type definition | Simple Type or Complex Type | |
| scope | A function with properties ("class": "Scope", "variety": "global" or "local", "parent": the containing Complex Type or Attribute Group) | |

| | | |
|------------------|--|--|
| value constraint | If present, a function with properties ("class": "Value Constraint", "variety": "fixed" or "default", "value": atomic value, "lexical form": string. Note that the "value" property is not available for namespace-sensitive types | |
| inheritable | boolean | |

Attribute Group Declaration

| Property name | Property type | Property value |
|--------------------|-----------------------------|--------------------------------------|
| kind | string | "Attribute Group Definition" |
| name | string | Local name of the attribute group |
| target namespace | string | Namespace URI of the attribute group |
| attribute uses | Sequence of (Attribute Use) | |
| attribute wildcard | Optional Attribute Wildcard | |

Attribute Use

| Property name | Property type | Property value |
|------------------|---------------------------|--|
| kind | string | "Attribute Use" |
| required | boolean | true if the attribute is required, false if optional |
| value constraint | See Attribute Declaration | |
| inheritable | boolean | |

Attribute Wildcard

| Property name | Property type | Property value |
|----------------------|---|----------------|
| kind | string | "Wildcard" |
| namespace constraint | function with properties ("class": "Namespace Constraint", "variety": "any" "enumeration" "not", "namespaces": sequence of xs:anyURI, "disallowed names": list containing QNames and/or the strings "defined" and "definedSiblings" | |
| process contents | string ("strict" "lax" "skip") | |

Complex Type

| Property name | Property type | Property value |
|---------------|---------------|----------------|
| kind | string | "Complex Type" |

| | | |
|--------------------------|--|--|
| name | string | Local name of the type (empty if anonymous) |
| target namespace | string | Namespace URI of the type (empty if anonymous) |
| base type definition | Complex Type Definition | |
| final | Sequence of strings ("restriction" "extension") | |
| context | Empty sequence (not implemented) | |
| derivation method | string ("restriction" "extension") | |
| abstract | boolean | |
| attribute uses | Sequence of Attribute Use | |
| attribute wildcard | Optional Attribute Wildcard | |
| content type | function with properties: ("class": "Content Type", "variety": string ("element-only" "empty" "mixed" "simple"), particle: optional Particle, "open content": function with properties ("class": "Open Content", "mode": string ("interleave" "suffix"), "wildcard": Wildcard), "simple type definition": Simple Type) | |
| prohibited substitutions | Sequence of strings ("restriction" "extension") | |
| assertions | Sequence of Assertion | |

Element Declaration

| Property name | Property type | Property value |
|------------------|--|--|
| kind | string | "Complex Type" |
| name | string | Local name of the type (empty if anonymous) |
| target namespace | string | Namespace URI of the type (empty if anonymous) |
| type definition | Simple Type or Complex Type | |
| type table | function with properties ("class": "Type Table", "alternatives": sequence of Type Alternative, "default type definition": Simple Type or Complex Type) | |
| scope | function with properties ("class": "Scope", "variety": ("global" "local"), "parent": optional Complex Type) | |
| value constraint | see Attribute Declaration | |

| | | |
|---------------------------------|--|--|
| nillable | boolean | |
| identity-constraint definitions | Sequence of Identity Constraint | |
| substitution group affiliations | Sequence of Element Declaration | |
| substitution group exclusions | Sequence of strings ("restriction" "extension") | |
| disallowed substitutions | Sequence of strings ("restriction" "extension" "substitution") | |
| abstract | boolean | |

[-] Element Wildcard

| Property name | Property type | Property value |
|----------------------|---|----------------|
| kind | string | "Wildcard" |
| namespace constraint | function with properties ("class": "Namespace Constraint", "variety": "any" "enumeration" "not", "namespaces": sequence of xs:anyURI, "disallowed names": list containing QName and/or the strings "defined" and "definedSiblings") | |
| process contents | string ("strict" "lax" "skip") | |

[-] Facet

| Property name | Property type | Property value |
|---------------|--|--|
| kind | string | The name of the facet, for example "minLength" or "enumeration" |
| value | depends on facet | The value of the facet |
| fixed | boolean | |
| typed-value | For the enumeration facet only, array(xs:anyAtomicType*) | An array containing the enumeration values, each of which may in general be a sequence of atomic values. (Note: for the enumeration facet, the "value" property is a sequence of strings, regardless of the actual type) |

[-] Identity Constraint

| Property name | Property type | Property value |
|---------------|---------------|----------------------------------|
| kind | string | "Identity-Constraint Definition" |

| | | |
|------------------------------|--|----------------------------------|
| name | string | Local name of the constraint |
| target namespace | string | Namespace URI of the constraint |
| identity-constraint category | string ("key" "unique" "keyRef") | |
| selector | XPath Property Record | |
| fields | Sequence of XPath Property Record | |
| referenced key | (For keyRef only): Identity Constraint | The corresponding key constraint |

[-] Model Group

| Property name | Property type | Property value |
|---------------|------------------------------------|----------------|
| kind | string | "Model Group" |
| compositor | string ("sequence" "choice" "all") | |
| particles | Sequence of Particle | |

[-] Model Group Definition

| Property name | Property type | Property value |
|------------------|---------------|----------------------------------|
| kind | string | "Model Group Definition" |
| name | string | Local name of the model group |
| target namespace | string | Namespace URI of the model group |
| model group | Model Group | |

[-] Notation

| Property name | Property type | Property value |
|-------------------|---------------|-------------------------------|
| kind | string | "Notation Declaration" |
| name | string | Local name of the notation |
| target namespace | string | Namespace URI of the notation |
| system identifier | anyURI | |
| public identifier | string | |

[-] Particle

| Property name | Property type | Property value |
|---------------|--|----------------|
| kind | string | "Particle" |
| min occurs | integer | |
| max occurs | integer, or string("unbounded") | |
| term | Element Declaration, Element Wildcard, or ModelGroup | |

Simple Type

| Property name | Property type | Property value |
|---------------------------|--|--|
| kind | string | "Simple Type Definition" |
| name | string | Local name of the type (empty if anonymous) |
| target namespace | string | Namespace URI of the type (empty if anonymous) |
| final | Sequence of string("restriction" "extension" "list" "union") | |
| context | containing component | |
| base type definition | Simple Type | |
| facets | Sequence of Facet | |
| fundamental facets | Empty sequence (not implemented) | |
| variety | string ("atomic" "list" "union") | |
| primitive type definition | Simple Type | |
| item type definition | (for list types only) Simple Type | |
| member type definitions | (for union types only) Sequence of Simple Type | |

Type Alternative

| Property name | Property type | Property value |
|-----------------|-----------------------------|--------------------|
| kind | string | "Type Alternative" |
| test | XPath Property Record | |
| type definition | Simple Type or Complex Type | |

XPath Property Record

| Property name | Property type | Property value |
|--------------------|---|---|
| namespace bindings | Sequence of functions with properties ("prefix": string, "namespace": anyURI) | |
| default namespace | anyURI | |
| base URI | anyURI | The static base URI of the XPath expression |
| expression | string | The XPath expression as a string |

Schema (two arguments)

```
altova:schema(ComponentKind as xs:string, Name as xs:QName) as (function(xs:string) as item(*)?) XP3.1 XQ3.1
```

Returns the component kind that is specified in the first argument which has a name that is the same as the name supplied in the second argument. You can navigate further by selecting one of the component's properties.

- If this property is a component, you can navigate another step deeper by selecting one of this component's properties. This step can be repeated to navigate further into the schema.
- If the component is an atomic value, the atomic value is returned and you cannot navigate any deeper.

Note: In XQuery expressions, the schema must be explicitly imported. In XPath expressions, the schema must have been imported into the processing environment, for example, into XSLT with the `xslt:import` instruction.

Examples

- ```
import schema "" at "C:\Test\ExpReport.xsd";
altova:schema("element declaration", xs:QName("OrgChart"))("type definition")
("content type")("particles")[3]!.("term")("kind")
```

returns the `kind` property of the term of the third `particles` component. This `particles` component is a descendant of the element declaration having a `QName` of `OrgChart`
- ```
import schema "" at "C:\Test\ExpReport.xsd";
let $typedef := altova:schema("type definition", xs:QName("emailType"))
for $facet in $typedef ("facets")
return [$facet ("kind"), $facet("value")]
```

returns, for each `facet` of each `emailType` component, an array containing that facet's kind and value

Components and their properties

Assertion

| Property name | Property type | Property value |
|---------------|-----------------------|----------------|
| kind | string | "Assertion" |
| test | XPath Property Record | |

Attribute Declaration

| Property name | Property type | Property value |
|------------------|--|--------------------------------|
| kind | string | "Attribute Declaration" |
| name | string | Local name of the attribute |
| target namespace | string | Namespace URI of the attribute |
| type definition | Simple Type or Complex Type | |
| scope | A function with properties ("class": "Scope", "variety": "global" or "local", "parent": the containing | |

| | | |
|------------------|--|--|
| | Complex Type or Attribute Group) | |
| value constraint | If present, a function with properties ("class": "Value Constraint", "variety": "fixed" or "default", "value": atomic value, "lexical form": string. Note that the "value" property is not available for namespace-sensitive types | |
| inheritable | boolean | |

Attribute Group Declaration

| Property name | Property type | Property value |
|--------------------|-----------------------------|--------------------------------------|
| kind | string | "Attribute Group Definition" |
| name | string | Local name of the attribute group |
| target namespace | string | Namespace URI of the attribute group |
| attribute uses | Sequence of (Attribute Use) | |
| attribute wildcard | Optional Attribute Wildcard | |

Attribute Use

| Property name | Property type | Property value |
|------------------|---------------------------|--|
| kind | string | "Attribute Use" |
| required | boolean | true if the attribute is required, false if optional |
| value constraint | See Attribute Declaration | |
| inheritable | boolean | |

Attribute Wildcard

| Property name | Property type | Property value |
|----------------------|---|----------------|
| kind | string | "Wildcard" |
| namespace constraint | function with properties ("class": "Namespace Constraint", "variety": "any" "enumeration" "not", "namespaces": sequence of xs:anyURI, "disallowed names": list containing QNames and/or the strings "defined" and "definedSiblings" | |
| process contents | string ("strict" "lax" "skip") | |

Complex Type

| Property name | Property type | Property value |
|---------------|---------------|----------------|
|---------------|---------------|----------------|

| | | |
|--------------------------|--|--|
| kind | string | "Complex Type" |
| name | string | Local name of the type (empty if anonymous) |
| target namespace | string | Namespace URI of the type (empty if anonymous) |
| base type definition | Complex Type Definition | |
| final | Sequence of strings ("restriction" "extension") | |
| context | Empty sequence (not implemented) | |
| derivation method | string ("restriction" "extension") | |
| abstract | boolean | |
| attribute uses | Sequence of Attribute Use | |
| attribute wildcard | Optional Attribute Wildcard | |
| content type | function with properties: ("class": "Content Type", "variety": string ("element-only" "empty" "mixed" "simple"), particle: optional Particle, "open content": function with properties ("class": "Open Content", "mode": string ("interleave" "suffix"), "wildcard": Wildcard), "simple type definition": Simple Type) | |
| prohibited substitutions | Sequence of strings ("restriction" "extension") | |
| assertions | Sequence of Assertion | |

Element Declaration

| Property name | Property type | Property value |
|------------------|--|--|
| kind | string | "Complex Type" |
| name | string | Local name of the type (empty if anonymous) |
| target namespace | string | Namespace URI of the type (empty if anonymous) |
| type definition | Simple Type or Complex Type | |
| type table | function with properties ("class": "Type Table", "alternatives": sequence of Type Alternative, "default type definition": Simple Type or Complex Type) | |
| scope | function with properties ("class": "Scope", "variety": ("global" "local"), "parent": optional Complex Type) | |

| | | |
|---------------------------------|--|--|
| value constraint | see Attribute Declaration | |
| nillable | boolean | |
| identity-constraint definitions | Sequence of Identity Constraint | |
| substitution group affiliations | Sequence of Element Declaration | |
| substitution group exclusions | Sequence of strings ("restriction" "extension") | |
| disallowed substitutions | Sequence of strings ("restriction" "extension" "substitution") | |
| abstract | boolean | |

[-] Element Wildcard

| Property name | Property type | Property value |
|----------------------|---|----------------|
| kind | string | "Wildcard" |
| namespace constraint | function with properties ("class": "Namespace Constraint", "variety": "any" "enumeration" "not", "namespaces": sequence of xs:anyURI, "disallowed names": list containing QNames and/or the strings "defined" and "definedSiblings" | |
| process contents | string ("strict" "lax" "skip") | |

[-] Facet

| Property name | Property type | Property value |
|---------------|--|--|
| kind | string | The name of the facet, for example "minLength" or "enumeration" |
| value | depends on facet | The value of the facet |
| fixed | boolean | |
| typed-value | For the enumeration facet only, array(xs:anyAtomicType*) | An array containing the enumeration values, each of which may in general be a sequence of atomic values. (Note: for the enumeration facet, the "value" property is a sequence of strings, regardless of the actual type) |

[-] Identity Constraint

| Property name | Property type | Property value |
|---------------|---------------|----------------|
|---------------|---------------|----------------|

| | | |
|------------------------------|--|----------------------------------|
| kind | string | "Identity-Constraint Definition" |
| name | string | Local name of the constraint |
| target namespace | string | Namespace URI of the constraint |
| identity-constraint category | string ("key" "unique" "keyRef") | |
| selector | XPath Property Record | |
| fields | Sequence of XPath Property Record | |
| referenced key | (For keyRef only): Identity Constraint | The corresponding key constraint |

[-] Model Group

| Property name | Property type | Property value |
|---------------|------------------------------------|----------------|
| kind | string | "Model Group" |
| compositor | string ("sequence" "choice" "all") | |
| particles | Sequence of Particle | |

[-] Model Group Definition

| Property name | Property type | Property value |
|------------------|---------------|----------------------------------|
| kind | string | "Model Group Definition" |
| name | string | Local name of the model group |
| target namespace | string | Namespace URI of the model group |
| model group | Model Group | |

[-] Notation

| Property name | Property type | Property value |
|-------------------|---------------|-------------------------------|
| kind | string | "Notation Declaration" |
| name | string | Local name of the notation |
| target namespace | string | Namespace URI of the notation |
| system identifier | anyURI | |
| public identifier | string | |

[-] Particle

| Property name | Property type | Property value |
|---------------|---------------------------------|----------------|
| kind | string | "Particle" |
| min occurs | integer | |
| max occurs | integer, or string("unbounded") | |

| | | |
|------|--|--|
| term | Element Declaration, Element Wildcard, or ModelGroup | |
|------|--|--|

Simple Type

| Property name | Property type | Property value |
|---------------------------|--|--|
| kind | string | "Simple Type Definition" |
| name | string | Local name of the type (empty if anonymous) |
| target namespace | string | Namespace URI of the type (empty if anonymous) |
| final | Sequence of string("restriction" "extension" "list" "union") | |
| context | containing component | |
| base type definition | Simple Type | |
| facets | Sequence of Facet | |
| fundamental facets | Empty sequence (not implemented) | |
| variety | string ("atomic" "list" "union") | |
| primitive type definition | Simple Type | |
| item type definition | (for list types only) Simple Type | |
| member type definitions | (for union types only) Sequence of Simple Type | |

Type Alternative

| Property name | Property type | Property value |
|-----------------|-----------------------------|--------------------|
| kind | string | "Type Alternative" |
| test | XPath Property Record | |
| type definition | Simple Type or Complex Type | |

XPath Property Record

| Property name | Property type | Property value |
|--------------------|---|---|
| namespace bindings | Sequence of functions with properties ("prefix": string, "namespace": anyURI) | |
| default namespace | anyURI | |
| base URI | anyURI | The static base URI of the XPath expression |
| expression | string | The XPath expression as a string |

▼ Type

`altova:type(Node as item?) as (function(xs:string) as item()*)? XP3.1 XQ3.1`

The function `altova:type` submits an element or attribute node of an XML document and returns the node's type information from the PSVI.

Note: The XML document must have a schema declaration so that the schema can be referenced.

☐ *Examples*

- `for $element in //Email`
`let $type := altova:type($element)`
`return $type`
 returns a function that contains the `Email` node's type information
- `for $element in //Email`
`let $type := altova:type($element)`
`return $type ("kind")`
 takes the `Email` node's type component (Simple Type or Complex Type) and returns the value of the component's `kind` property

The "`_props`" parameter returns the properties of the selected component. For example:

- `for $element in //Email`
`let $type := altova:type($element)`
`return ($type ("kind"), $type ("_props"))`
 takes the `Email` node's type component (Simple Type or Complex Type) and returns (i) the value of the component's `kind` property, and then (ii) the properties of that component.

Components and their properties

☐ Assertion

| Property name | Property type | Property value |
|---------------|-----------------------|----------------|
| kind | string | "Assertion" |
| test | XPath Property Record | |

☐ Attribute Declaration

| Property name | Property type | Property value |
|------------------|---|--------------------------------|
| kind | string | "Attribute Declaration" |
| name | string | Local name of the attribute |
| target namespace | string | Namespace URI of the attribute |
| type definition | Simple Type or Complex Type | |
| scope | A function with properties
("class": "Scope", "variety": "global" or "local", "parent": the containing | |

| | | |
|------------------|--|--|
| | Complex Type or Attribute Group) | |
| value constraint | If present, a function with properties ("class": "Value Constraint", "variety": "fixed" or "default", "value": atomic value, "lexical form": string. Note that the "value" property is not available for namespace-sensitive types | |
| inheritable | boolean | |

Attribute Group Declaration

| Property name | Property type | Property value |
|--------------------|-----------------------------|--------------------------------------|
| kind | string | "Attribute Group Definition" |
| name | string | Local name of the attribute group |
| target namespace | string | Namespace URI of the attribute group |
| attribute uses | Sequence of (Attribute Use) | |
| attribute wildcard | Optional Attribute Wildcard | |

Attribute Use

| Property name | Property type | Property value |
|------------------|---------------------------|--|
| kind | string | "Attribute Use" |
| required | boolean | true if the attribute is required, false if optional |
| value constraint | See Attribute Declaration | |
| inheritable | boolean | |

Attribute Wildcard

| Property name | Property type | Property value |
|----------------------|---|----------------|
| kind | string | "Wildcard" |
| namespace constraint | function with properties ("class": "Namespace Constraint", "variety": "any" "enumeration" "not", "namespaces": sequence of xs:anyURI, "disallowed names": list containing QNames and/or the strings "defined" and "definedSiblings" | |
| process contents | string ("strict" "lax" "skip") | |

Complex Type

| Property name | Property type | Property value |
|---------------|---------------|----------------|
|---------------|---------------|----------------|

| | | |
|--------------------------|--|--|
| kind | string | "Complex Type" |
| name | string | Local name of the type (empty if anonymous) |
| target namespace | string | Namespace URI of the type (empty if anonymous) |
| base type definition | Complex Type Definition | |
| final | Sequence of strings ("restriction" "extension") | |
| context | Empty sequence (not implemented) | |
| derivation method | string ("restriction" "extension") | |
| abstract | boolean | |
| attribute uses | Sequence of Attribute Use | |
| attribute wildcard | Optional Attribute Wildcard | |
| content type | function with properties: ("class": "Content Type", "variety": string ("element-only" "empty" "mixed" "simple"), particle: optional Particle, "open content": function with properties ("class": "Open Content", "mode": string ("interleave" "suffix"), "wildcard": Wildcard), "simple type definition": Simple Type) | |
| prohibited substitutions | Sequence of strings ("restriction" "extension") | |
| assertions | Sequence of Assertion | |

Element Declaration

| Property name | Property type | Property value |
|------------------|--|--|
| kind | string | "Complex Type" |
| name | string | Local name of the type (empty if anonymous) |
| target namespace | string | Namespace URI of the type (empty if anonymous) |
| type definition | Simple Type or Complex Type | |
| type table | function with properties ("class": "Type Table", "alternatives": sequence of Type Alternative, "default type definition": Simple Type or Complex Type) | |
| scope | function with properties ("class": "Scope", "variety": ("global" "local"), "parent": optional Complex Type) | |

| | | |
|---------------------------------|--|--|
| value constraint | see Attribute Declaration | |
| nillable | boolean | |
| identity-constraint definitions | Sequence of Identity Constraint | |
| substitution group affiliations | Sequence of Element Declaration | |
| substitution group exclusions | Sequence of strings ("restriction" "extension") | |
| disallowed substitutions | Sequence of strings ("restriction" "extension" "substitution") | |
| abstract | boolean | |

[-] Element Wildcard

| Property name | Property type | Property value |
|----------------------|---|----------------|
| kind | string | "Wildcard" |
| namespace constraint | function with properties ("class": "Namespace Constraint", "variety": "any" "enumeration" "not", "namespaces": sequence of xs:anyURI, "disallowed names": list containing QNames and/or the strings "defined" and "definedSiblings" | |
| process contents | string ("strict" "lax" "skip") | |

[-] Facet

| Property name | Property type | Property value |
|---------------|--|--|
| kind | string | The name of the facet, for example "minLength" or "enumeration" |
| value | depends on facet | The value of the facet |
| fixed | boolean | |
| typed-value | For the enumeration facet only, array(xs:anyAtomicType*) | An array containing the enumeration values, each of which may in general be a sequence of atomic values. (Note: for the enumeration facet, the "value" property is a sequence of strings, regardless of the actual type) |

[-] Identity Constraint

| Property name | Property type | Property value |
|---------------|---------------|----------------|
|---------------|---------------|----------------|

| | | |
|------------------------------|--|----------------------------------|
| kind | string | "Identity-Constraint Definition" |
| name | string | Local name of the constraint |
| target namespace | string | Namespace URI of the constraint |
| identity-constraint category | string ("key" "unique" "keyRef") | |
| selector | XPath Property Record | |
| fields | Sequence of XPath Property Record | |
| referenced key | (For keyRef only): Identity Constraint | The corresponding key constraint |

[-] Model Group

| Property name | Property type | Property value |
|---------------|------------------------------------|----------------|
| kind | string | "Model Group" |
| compositor | string ("sequence" "choice" "all") | |
| particles | Sequence of Particle | |

[-] Model Group Definition

| Property name | Property type | Property value |
|------------------|---------------|----------------------------------|
| kind | string | "Model Group Definition" |
| name | string | Local name of the model group |
| target namespace | string | Namespace URI of the model group |
| model group | Model Group | |

[-] Notation

| Property name | Property type | Property value |
|-------------------|---------------|-------------------------------|
| kind | string | "Notation Declaration" |
| name | string | Local name of the notation |
| target namespace | string | Namespace URI of the notation |
| system identifier | anyURI | |
| public identifier | string | |

[-] Particle

| Property name | Property type | Property value |
|---------------|---------------------------------|----------------|
| kind | string | "Particle" |
| min occurs | integer | |
| max occurs | integer, or string("unbounded") | |

| | | |
|------|--|--|
| term | Element Declaration, Element Wildcard, or ModelGroup | |
|------|--|--|

Simple Type

| Property name | Property type | Property value |
|---------------------------|--|--|
| kind | string | "Simple Type Definition" |
| name | string | Local name of the type (empty if anonymous) |
| target namespace | string | Namespace URI of the type (empty if anonymous) |
| final | Sequence of string("restriction" "extension" "list" "union") | |
| context | containing component | |
| base type definition | Simple Type | |
| facets | Sequence of Facet | |
| fundamental facets | Empty sequence (not implemented) | |
| variety | string ("atomic" "list" "union") | |
| primitive type definition | Simple Type | |
| item type definition | (for list types only) Simple Type | |
| member type definitions | (for union types only) Sequence of Simple Type | |

Type Alternative

| Property name | Property type | Property value |
|-----------------|-----------------------------|--------------------|
| kind | string | "Type Alternative" |
| test | XPath Property Record | |
| type definition | Simple Type or Complex Type | |

XPath Property Record

| Property name | Property type | Property value |
|--------------------|---|---|
| namespace bindings | Sequence of functions with properties ("prefix": string, "namespace": anyURI) | |
| default namespace | anyURI | |
| base URI | anyURI | The static base URI of the XPath expression |
| expression | string | The XPath expression as a string |

27.2.1.7 XPath/XQuery Functions: Sequence

Altova's sequence extension functions can be used in XPath and XQuery expressions and provide additional functionality for the processing of data. The functions in this section can be used with Altova's **XPath 3.0** and **XQuery 3.0** engines. They are available in XPath/XQuery contexts.

Note about naming of functions and language applicability

Altova extension functions can be used in XPath/XQuery expressions. They provide additional functionality to the functionality that is available in the standard library of XPath, XQuery, and XSLT functions. Altova extension functions are in the **Altova extension functions namespace**, <http://www.altova.com/xslt-extensions>, and are indicated in this section with the prefix **altova:**, which is assumed to be bound to this namespace. Note that, in future versions of your product, support for a function might be discontinued or the behavior of individual functions might change. Consult the documentation of future releases for information about support for Altova extension functions in that release.

| | |
|---|--------------------------|
| <i>XPath functions (used in XPath expressions in XSLT):</i> | XP1 XP2 XP3.1 |
| <i>XSLT functions (used in XPath expressions in XSLT):</i> | XSLT1 XSLT2 XSLT3 |
| <i>XQuery functions (used in XQuery expressions in XQuery):</i> | XQ1 XQ3.1 |

▼ attributes [altova:]

altova:attributes(AttributeName as xs:string) as attribute()* **XP3.1 XQ3.1**

Returns all attributes that have a local name which is the same as the name supplied in the input argument, *AttributeName*. The search is case-sensitive and conducted along the `attribute::` axis. This means that the context node must be the parent element node.

☐ Examples

- **altova:attributes("MyAttribute")** returns `MyAttribute()*`

altova:attributes(AttributeName as xs:string, SearchOptions as xs:string) as attribute()* **XP3.1 XQ3.1**

Returns all attributes that have a local name which is the same as the name supplied in the input argument, *AttributeName*. The search is case-sensitive and conducted along the `attribute::` axis. The context node must be the parent element node. The second argument is a string containing option flags. Available flags are:

r = switches to a regular-expression search; *AttributeName* must then be a regular-expression search string;

f = If this option is specified, then *AttributeName* provides a full match; otherwise *AttributeName* need only partially match an attribute name to return that attribute. For example: if **f** is not specified, then `MyAtt` will return `MyAttribute`;

i = switches to a case-insensitive search;

p = includes the namespace prefix in the search; *AttributeName* should then contain the namespace prefix, for example: `altova:MyAttribute`.

The flags can be written in any order. Invalid flags will generate errors. One or more flags can be omitted. The empty string is allowed, and will produce the same effect as the function having only one argument

(*previous signature*). However, an empty sequence is not allowed as the second argument.

☐ Examples

- `altova:attributes("MyAttribute", "rfip")` returns `MyAttribute()*`
- `altova:attributes("MyAttribute", "pri")` returns `MyAttribute()*`
- `altova:attributes("MyAtt", "rip")` returns `MyAttribute()*`
- `altova:attributes("MyAttributes", "rfip")` returns no match
- `altova:attributes("MyAttribute", "")` returns `MyAttribute()*`
- `altova:attributes("MyAttribute", "Rip")` returns an unrecognized-flag error.
- `altova:attributes("MyAttribute",)` returns a missing-second-argument error.

▼ elements [altova:]

`altova:elements(ElementName as xs:string) as element()*` **XP3.1 XQ3.1**

Returns all elements that have a local name which is the same as the name supplied in the input argument, `ElementName`. The search is case-sensitive and conducted along the `child::` axis. The context node must be the parent node of the element/s being searched for.

☐ Examples

- `altova:elements("MyElement")` returns `MyElement()*`

`altova:elements(ElementName as xs:string, SearchOptions as xs:string) as element()*`
XP3.1 XQ3.1

Returns all elements that have a local name which is the same as the name supplied in the input argument, `ElementName`. The search is case-sensitive and conducted along the `child::` axis. The context node must be the parent node of the element/s being searched for. The second argument is a string containing option flags. Available flags are:

r = switches to a regular-expression search; `ElementName` must then be a regular-expression search string;

f = If this option is specified, then `ElementName` provides a full match; otherwise `ElementName` need only partially match an element name to return that element. For example: if **f** is not specified, then `MyElem` will return `MyElement`;

i = switches to a case-insensitive search;

p = includes the namespace prefix in the search; `ElementName` should then contain the namespace prefix, for example: `altova:MyElement`.

The flags can be written in any order. Invalid flags will generate errors. One or more flags can be omitted.

The empty string is allowed, and will produce the same effect as the function having only one argument (*previous signature*). However, an empty sequence is not allowed.

☐ Examples

- `altova:elements("MyElement", "rip")` returns `MyElement()*`
- `altova:elements("MyElement", "pri")` returns `MyElement()*`
- `altova:elements("MyElement", "")` returns `MyElement()*`
- `altova:elements("MyElem", "rip")` returns `MyElement()*`
- `altova:elements("MyElements", "rfip")` returns no match
- `altova:elements("MyElement", "Rip")` returns an unrecognized-flag error.
- `altova:elements("MyElement",)` returns a missing-second-argument error.

▼ find-first [altova:]

`altova:find-first((Sequence as item()*), (Condition(Sequence-Item as xs:boolean)) as item())? XP3.1 XQ3.1`

This function takes two arguments. The first argument is a sequence of one or more items of any datatype. The second argument, `Condition`, is a reference to an XPath function that takes one argument (has an arity of 1) and returns a boolean. Each item of `sequence` is submitted, in turn, to the function referenced in `Condition`. (*Remember:* This function takes a single argument.) The first `sequence` item that causes the function in `Condition` to evaluate to `true()` is returned as the result of `altova:find-first`, and the iteration stops.

Examples

- `altova:find-first(5 to 10, function($a) {$a mod 2 = 0})` returns `xs:integer 6`
The `Condition` argument references the XPath 3.0 inline function, `function()`, which declares an inline function named `$a` and then defines it. Each item in the `sequence` argument of `altova:find-first` is passed, in turn, to `$a` as its input value. The input value is tested on the condition in the function definition (`$a mod 2 = 0`). The first input value to satisfy this condition is returned as the result of `altova:find-first` (in this case 6).
- `altova:find-first((1 to 10), (function($a) {$a+3=7}))` returns `xs:integer 4`

Further examples

If the file `C:\Temp\Customers.xml` exists:

- `altova:find-first("C:\Temp\Customers.xml", "http://www.altova.com/index.html"), (doc-available#1))` returns `xs:string C:\Temp\Customers.xml`

If the file `C:\Temp\Customers.xml` does not exist, and `http://www.altova.com/index.html` exists:

- `altova:find-first("C:\Temp\Customers.xml", "http://www.altova.com/index.html"), (doc-available#1))` returns `xs:string http://www.altova.com/index.html`

If the file `C:\Temp\Customers.xml` does not exist, and `http://www.altova.com/index.html` also does not exist:

- `altova:find-first("C:\Temp\Customers.xml", "http://www.altova.com/index.html"), (doc-available#1))` returns no result

Notes about the examples given above

- The XPath 3.0 function, `doc-available`, takes a single string argument, which is used as a URI, and returns `true` if a document node is found at the submitted URI. (The document at the submitted URI must therefore be an XML document.)
- The `doc-available` function can be used for `Condition`, the second argument of `altova:find-first`, because it takes only one argument (arity=1), because it takes an `item()` as input (a string which is used as a URI), and returns a boolean value.
- Notice that the `doc-available` function is only referenced, not called. The `#1` suffix that is attached to it indicates a function with an arity of 1. In its entirety `doc-available#1` simply means: *Use the doc-available() function that has arity=1, passing to it as its single argument, in turn, each of the items in the first sequence.* As a result, each of the two strings will be passed

to `doc-available()`, which uses the string as a URI and tests whether a document node exists at the URI. If one does, the `doc-available()` evaluates to `true()` and that string is returned as the result of the `altova:find-first` function. *Note about the `doc-available()` function: Relative paths are resolved relative to the the current base URI, which is by default the URI of the XML document from which the function is loaded.*

▼ find-first-combination [altova:]

```
altova:find-first-combination((Seq-01 as item()*), (Seq-02 as item()*),
(Condition( Seq-01-Item, Seq-02-Item as xs:boolean)) as item()* XP3.1 XQ3.1
```

This function takes three arguments:

- The first two arguments, `seq-01` and `seq-02`, are sequences of one or more items of any datatype.
- The third argument, `condition`, is a reference to an XPath function that takes two arguments (has an arity of 2) and returns a boolean.

The items of `seq-01` and `seq-02` are passed in ordered pairs (one item from each sequence making up a pair) as the arguments of the function in `condition`. The pairs are ordered as follows.

```
If   Seq-01 = X1, X2, X3 ... Xn
And  Seq-02 = Y1, Y2, Y3 ... Yn
Then (X1 Y1), (X1 Y2), (X1 Y3) ... (X1 Yn), (X2 Y1), (X2 Y2) ... (Xn Yn)
```

The first ordered pair that causes the `condition` function to evaluate to `true()` is returned as the result of `altova:find-first-combination`. Note that: (i) If the `condition` function iterates through the submitted argument pairs and does not once evaluate to `true()`, then `altova:find-first-combination` returns *No results*; (ii) The result of `altova:find-first-combination` will always be a pair of items (of any datatype) or no item at all.

▢ Examples

- `altova:find-first-combination(11 to 20, 21 to 30, function($a, $b) {$a+$b = 32})` returns the sequence of `xs:integers (11, 21)`
- `altova:find-first-combination(11 to 20, 21 to 30, function($a, $b) {$a+$b = 33})` returns the sequence of `xs:integers (11, 22)`
- `altova:find-first-combination(11 to 20, 21 to 30, function($a, $b) {$a+$b = 34})` returns the sequence of `xs:integers (11, 23)`

▼ find-first-pair [altova:]

```
altova:find-first-pair((Seq-01 as item()*), (Seq-02 as item()*), (Condition( Seq-01-
Item, Seq-02-Item as xs:boolean)) as item()* XP3.1 XQ3.1
```

This function takes three arguments:

- The first two arguments, `seq-01` and `seq-02`, are sequences of one or more items of any datatype.
- The third argument, `condition`, is a reference to an XPath function that takes two arguments (has an arity of 2) and returns a boolean.

The items of `seq-01` and `seq-02` are passed in ordered pairs as the arguments of the function in `Condition`. The pairs are ordered as follows.

```
If   Seq-01 = X1, X2, X3 ... Xn
And  Seq-02 = Y1, Y2, Y3 ... Yn
Then (X1 Y1), (X2 Y2), (X3 Y3) ... (Xn Yn)
```

The first ordered pair that causes the `Condition` function to evaluate to `true()` is returned as the result of `altova:find-first-pair`. Note that: (i) If the `Condition` function iterates through the submitted argument pairs and does not once evaluate to `true()`, then `altova:find-first-pair` returns *No results*; (ii) The result of `altova:find-first-pair` will always be a pair of items (of any datatype) or no item at all.

Examples

- `altova:find-first-pair(11 to 20, 21 to 30, function($a, $b) {$a+$b = 32})` returns the sequence of `xs:integers` (11, 21)
- `altova:find-first-pair(11 to 20, 21 to 30, function($a, $b) {$a+$b = 33})` returns *No results*

Notice from the two examples above that the ordering of the pairs is: (11, 21) (12, 22) (13, 23) ... (20, 30). This is why the second example returns *No results* (because no ordered pair gives a sum of 33).

▼ find-first-pair-pos [altova:]

```
altova:find-first-pair-pos((Seq-01 as item()*), (Seq-02 as item()*), (Condition( Seq-01-Item, Seq-02-Item as xs:boolean)) as xs:integer XP3.1 XQ3.1)
```

This function takes three arguments:

- The first two arguments, `seq-01` and `seq-02`, are sequences of one or more items of any datatype.
- The third argument, `Condition`, is a reference to an XPath function that takes two arguments (has an arity of 2) and returns a boolean.

The items of `seq-01` and `seq-02` are passed in ordered pairs as the arguments of the function in `Condition`. The pairs are ordered as follows.

```
If   Seq-01 = X1, X2, X3 ... Xn
And  Seq-02 = Y1, Y2, Y3 ... Yn
Then (X1 Y1), (X2 Y2), (X3 Y3) ... (Xn Yn)
```

The index position of the first ordered pair that causes the `Condition` function to evaluate to `true()` is returned as the result of `altova:find-first-pair-pos`. Note that if the `Condition` function iterates through the submitted argument pairs and does not once evaluate to `true()`, then `altova:find-first-pair-pos` returns *No results*.

Examples

- `altova:find-first-pair-pos(11 to 20, 21 to 30, function($a, $b) {$a+$b = 32})` returns 1
- `altova:find-first-pair-pos(11 to 20, 21 to 30, function($a, $b) {$a+$b = 33})`

returns *No results*

Notice from the two examples above that the ordering of the pairs is: (11, 21) (12, 22) (13, 23) ... (20, 30). In the first example, the first pair causes the `Condition` function to evaluate to `true()`, and so its index position in the sequence, 1, is returned. The second example returns *No results* because no pair gives a sum of 33.

▼ find-first-pos [altova:]

```
altova:find-first-pos((Sequence as item()*), (Condition( Sequence-Item as xs:boolean)
as xs:integer XP3.1 XQ3.1
```

This function takes two arguments. The first argument is a sequence of one or more items of any datatype. The second argument, `Condition`, is a reference to an XPath function that takes one argument (has an arity of 1) and returns a boolean. Each item of `Sequence` is submitted, in turn, to the function referenced in `Condition`. (*Remember:* This function takes a single argument.) The first `Sequence` item that causes the function in `Condition` to evaluate to `true()` has its index position in `Sequence` returned as the result of `altova:find-first-pos`, and the iteration stops.

▣ Examples

- `altova:find-first-pos(5 to 10, function($a) {$a mod 2 = 0})` returns `xs:integer 2`
The `Condition` argument references the XPath 3.0 inline function, `function()`, which declares an inline function named `$a` and then defines it. Each item in the `Sequence` argument of `altova:find-first-pos` is passed, in turn, to `$a` as its input value. The input value is tested on the condition in the function definition (`$a mod 2 = 0`). The index position in the sequence of the first input value to satisfy this condition is returned as the result of `altova:find-first-pos` (in this case 2, since 6, the first value (in the sequence) to satisfy the condition, is at index position 2 in the sequence).
- `altova:find-first-pos((2 to 10), (function($a) {$a+3=7}))` returns `xs:integer 3`

Further examples

If the file `C:\Temp\Customers.xml` exists:

- `altova:find-first-pos("C:\Temp\Customers.xml", "http://www.altova.com/index.html", (doc-available#1))` returns `1`

If the file `C:\Temp\Customers.xml` does not exist, and `http://www.altova.com/index.html` exists:

- `altova:find-first-pos("C:\Temp\Customers.xml", "http://www.altova.com/index.html", (doc-available#1))` returns `2`

If the file `C:\Temp\Customers.xml` does not exist, and `http://www.altova.com/index.html` also does not exist:

- `altova:find-first-pos("C:\Temp\Customers.xml", "http://www.altova.com/index.html", (doc-available#1))` returns `no result`

Notes about the examples given above

- The XPath 3.0 function, `doc-available`, takes a single string argument, which is used as a URI, and returns `true` if a document node is found at the submitted URI. (The document at the submitted URI must therefore be an XML document.)
- The `doc-available` function can be used for `Condition`, the second argument of `altova:find-first-pos`, because it takes only one argument (arity=1), because it takes an `item()` as input (a string which is used as a URI), and returns a boolean value.
- Notice that the `doc-available` function is only referenced, not called. The `#1` suffix that is attached to it indicates a function with an arity of 1. In its entirety `doc-available#1` simply means: *Use the `doc-available()` function that has arity=1, passing to it as its single argument, in turn, each of the items in the first sequence.* As a result, each of the two strings will be passed to `doc-available()`, which uses the string as a URI and tests whether a document node exists at the URI. If one does, the `doc-available()` function evaluates to `true()` and the index position of that string in the sequence is returned as the result of the `altova:find-first-pos` function. *Note about the `doc-available()` function: Relative paths are resolved relative to the current base URI, which is by default the URI of the XML document from which the function is loaded.*

▼ for-each-attribute-pair [altova:]

`altova:for-each-attribute-pair(Seq1 as element()?, Seq2 as element()?, Function as function()) as item()* XP3.1 XQ3.1`

The first two arguments identify two elements, the attributes of which are used to build attribute pairs, where one attribute of a pair is obtained from the first element and the other attribute is obtained from the second element. Attribute pairs are selected on the basis of having the same name, and the pairs are ordered alphabetically (on their names) into a set. If, for one attribute no corresponding attribute on the other element exists, then the pair is "disjoint", meaning that it consists of one member only. The function `item` (third argument `Function`) is applied separately to each pair in the sequence of pairs (joint and disjoint), resulting in an output that is a sequence of items.

▣ Examples

- `altova:for-each-attribute-pair(/Example/Test-A, /Example/Test-B, function($a, $b) {$a+b})` returns ...

```
(2, 4, 6) if
<Test-A att1="1" att2="2" att3="3" />
<Test-B att1="1" att2="2" att3="3" />
```

```
(2, 4, 6) if
<Test-A att2="2" att1="1" att3="3" />
<Test-B att3="3" att2="2" att1="1" />
```

```
(2, 6) if
<Test-A att4="4" att1="1" att3="3" />
<Test-B att3="3" att2="2" att1="1" />
```

Note: The result (2, 6) is obtained by way of the following action: (1+1, ()+2, 3+3, 4+()). If one of the operands is the empty sequence, as in the case of items 2 and 4, then the result of the addition is an empty sequence.

- `altova:for-each-attribute-pair(/Example/Test-A, /Example/Test-B, concat#2)` returns

...

```
(11, 22, 33) if
<Test-A att1="1" att2="2" att3="3" />
<Test-B att1="1" att2="2" att3="3" />

(11, 2, 33, 4) if
<Test-A att4="4" att1="1" att3="3" />
<Test-B att3="3" att2="2" att1="1" />
```

▼ for-each-combination [altova:]

altova:for-each-combination(FirstSequence as item()*, SecondSequence as item()*, Function(\$i,\$j){\$i || \$j}) as item()* **XP3.1 XQ3.1**

The items of the two sequences in the first two arguments are combined so that each item of the first sequence is combined, in order, once with each item of the second sequence. The function given as the third argument is applied to each combination in the resulting sequence, resulting in an output that is a sequence of items (see *example*).

▣ Examples

- **altova:for-each-combination**(('a', 'b', 'c'), ('1', '2', '3'), function(\$i, \$j) {\$i || \$j}) returns ('a1', 'a2', 'a3', 'b1', 'b2', 'b3', 'c1', 'c2', 'c3')

▼ for-each-matching-attribute-pair [altova:]

altova:for-each-matching-attribute-pair(Seq1 as element()?, Seq2 as element()?, Function as function()) as item()* **XP3.1 XQ3.1**

The first two arguments identify two elements, the attributes of which are used to build attribute pairs, where one attribute of a pair is obtained from the first element and the other attribute is obtained from the second element. Attribute pairs are selected on the basis of having the same name, and the pairs are ordered alphabetically (on their names) into a set. If, for one attribute no corresponding attribute on the other element exists, then no pair is built. The function item (third argument *Function*) is applied separately to each pair in the sequence of pairs, resulting in an output that is a sequence of items.

▣ Examples

- **altova:for-each-matching-attribute-pair**(/Example/Test-A, /Example/Test-B, function(\$a, \$b){\$a+b}) returns ...

```
(2, 4, 6) if
<Test-A att1="1" att2="2" att3="3" />
<Test-B att1="1" att2="2" att3="3" />

(2, 4, 6) if
<Test-A att2="2" att1="1" att3="3" />
<Test-B att3="3" att2="2" att1="1" />

(2, 6) if
<Test-A att4="4" att1="1" att3="3" />
<Test-B att3="3" att2="2" att3="1" />
```

- `altova:for-each-matching-attribute-pair` (/Example/Test-A, /Example/Test-B, concat#2) returns ...

```
(11, 22, 33) if
<Test-A att1="1" att2="2" att3="3" />
<Test-B att1="1" att2="2" att3="3" />

(11, 33) if
<Test-A att4="4" att1="1" att3="3" />
<Test-B att3="3" att2="2" att1="1" />
```

▼ substitute-empty [altova:]

`altova:substitute-empty`(FirstSequence as item()*, SecondSequence as item()) as item()*
XP3.1 XQ3.1

If FirstSequence is empty, returns SecondSequence. If FirstSequence is not empty, returns FirstSequence.

▣ Examples

- `altova:substitute-empty`((1,2,3), (4,5,6)) returns (1,2,3)
- `altova:substitute-empty`((), (4,5,6)) returns (4,5,6)

27.2.1.8 XPath/XQuery Functions: String

Altova's string extension functions can be used in XPath and XQuery expressions and provide additional functionality for the processing of data. The functions in this section can be used with Altova's **XPath 3.0** and **XQuery 3.0** engines. They are available in XPath/XQuery contexts.

Note about naming of functions and language applicability

Altova extension functions can be used in XPath/XQuery expressions. They provide additional functionality to the functionality that is available in the standard library of XPath, XQuery, and XSLT functions. Altova extension functions are in the **Altova extension functions namespace**, <http://www.altova.com/xslt-extensions>, and are indicated in this section with the prefix `altova:`, which is assumed to be bound to this namespace. Note that, in future versions of your product, support for a function might be discontinued or the behavior of individual functions might change. Consult the documentation of future releases for information about support for Altova extension functions in that release.

| | |
|---|--------------------------|
| <i>XPath functions (used in XPath expressions in XSLT):</i> | XP1 XP2 XP3.1 |
| <i>XSLT functions (used in XPath expressions in XSLT):</i> | XSLT1 XSLT2 XSLT3 |
| <i>XQuery functions (used in XQuery expressions in XQuery):</i> | XQ1 XQ3.1 |

▼ camel-case [altova:]

`altova:camel-case`(InputString as xs:string) as xs:string **XP3.1 XQ3.1**

Returns the input string `InputString` in CamelCase. The string is analyzed using the regular expression `'\s'` (which is a shortcut for the whitespace character). The first non-whitespace character after a whitespace or sequence of consecutive whitespaces is capitalized. The first character in the output string is capitalized.

▣ Examples

- `altova:camel-case("max")` returns `Max`
- `altova:camel-case("max max")` returns `Max Max`
- `altova:camel-case("file01.xml")` returns `File01.xml`
- `altova:camel-case("file01.xml file02.xml")` returns `File01.xml File02.xml`
- `altova:camel-case("file01.xml file02.xml")` returns `File01.xml File02.xml`
- `altova:camel-case("file01.xml -file02.xml")` returns `File01.xml -file02.xml`

`altova:camel-case(InputString as xs:string, SplitChars as xs:string, IsRegex as xs:boolean) as xs:string XP3.1 XQ3.1`

Converts the input string `InputString` to camel case by using `SplitChars` to determine the character/s that trigger the next capitalization. `SplitChars` is used as a regular expression when `IsRegex = true()`, or as plain characters when `IsRegex = false()`. The first character in the output string is capitalized.

▣ Examples

- `altova:camel-case("setname getname", "set|get", true())` returns `setName getName`
- `altova:camel-case("altova\documents\testcases", "\", false())` returns `Altova\Documents\Testcases`

▼ char [altova:]

`altova:char(Position as xs:integer) as xs:string XP3.1 XQ3.1`

Returns a string containing the character at the position specified by the `Position` argument, in the string obtained by converting the value of the context item to `xs:string`. The result string will be empty if no character exists at the index submitted by the `Position` argument.

▣ Examples

If the context item is `1234ABCD`:

- `altova:char(2)` returns `2`
- `altova:char(5)` returns `A`
- `altova:char(9)` returns the empty string.
- `altova:char(-2)` returns the empty string.

`altova:char(InputString as xs:string, Position as xs:integer) as xs:string XP3.1 XQ3.1`

Returns a string containing the character at the position specified by the `Position` argument, in the string submitted as the `InputString` argument. The result string will be empty if no character exists at the index submitted by the `Position` argument.

▣ Examples

- `altova:char("2014-01-15", 5)` returns `-`
- `altova:char("USA", 1)` returns `U`
- `altova:char("USA", 10)` returns the empty string.
- `altova:char("USA", -2)` returns the empty string.

▼ create-hash-from-string[altova:]

altova:create-hash-from-string(*InputString* as *xs:string*) as *xs:string* **XP2 XQ1 XP3.1 XQ3.1**

altova:create-hash-from-string(*InputString* as *xs:string*, *HashAlgo* as *xs:string*) as *xs:string* **XP2 XQ1 XP3.1 XQ3.1**

Generates a hash string from *InputString* by using the hashing algorithm specified by the *HashAlgo* argument. The following hashing algorithms may be specified (in upper or lower case): MD5, SHA-1, SHA-224, SHA-256, SHA-384, SHA-512. If the second argument is not specified (see the first signature above), then the SHA-256 hashing algorithm is used.

☐ Examples

- **altova:create-hash-from-string**('abc') returns a hash string generated by using the SHA-256 hashing algorithm.
- **altova:create-hash-from-string**('abc', 'md5') returns a hash string generated by using the MD5 hashing algorithm.
- **altova:create-hash-from-string**('abc', 'MD5') returns a hash string generated by using the MD5 hashing algorithm.

▼ first-chars [altova:]

altova:first-chars(*X-Number* as *xs:integer*) as *xs:string* **XP3.1 XQ3.1**

Returns a string containing the first *X-Number* of characters of the string obtained by converting the value of the context item to *xs:string*.

☐ Examples

If the context item is 1234ABCD:

- **altova:first-chars**(2) returns 12
- **altova:first-chars**(5) returns 1234A
- **altova:first-chars**(9) returns 1234ABCD

altova:first-chars(*InputString* as *xs:string*, *X-Number* as *xs:integer*) as *xs:string* **XP3.1 XQ3.1**

Returns a string containing the first *X-Number* of characters of the string submitted as the *InputString* argument.

☐ Examples

- **altova:first-chars**("2014-01-15", 5) returns 2014-
- **altova:first-chars**("USA", 1) returns U

▼ format-string [altova:]

altova:format-string(*InputString* as *xs:string*, *FormatSequence* as *item()**) as *xs:string* **XP3.1 XQ3.1**

The input string (first argument) contains positional parameters (%1, %2, etc). Each parameter is replaced by the string item that is located at the corresponding position in the format sequence (submitted as the second argument). So the first item in the format sequence replaces the positional parameter %1, the second item replaces %2, and so on. The function returns this formatted string that contains the replacements. If no string exists for a positional parameter, then the positional parameter itself is returned. This happens when the index of a positional parameter is greater than the number of items in the format sequence.

Examples

- `altova:format-string('Hello %1, %2, %3', ('Jane','John','Joe'))` returns "Hello Jane, John, Joe"
- `altova:format-string('Hello %1, %2, %3', ('Jane','John','Joe', 'Tom'))` returns "Hello Jane, John, Joe"
- `altova:format-string('Hello %1, %2, %4', ('Jane','John','Joe', 'Tom'))` returns "Hello Jane, John, Tom"
- `altova:format-string('Hello %1, %2, %4', ('Jane','John','Joe'))` returns "Hello Jane, John, %4"

last-chars [altova:]

`altova:last-chars(X-Number as xs:integer) as xs:string` **XP3.1 XQ3.1**

Returns a string containing the last X-Number of characters of the string obtained by converting the value of the context item to `xs:string`.

Examples

If the context item is 1234ABCD:

- `altova:last-chars(2)` returns CD
- `altova:last-chars(5)` returns 4ABCD
- `altova:last-chars(9)` returns 1234ABCD

`altova:last-chars(InputChange as xs:string, X-Number as xs:integer) as xs:string` **XP3.1 XQ3.1**

Returns a string containing the last X-Number of characters of the string submitted as the `InputChange` argument.

Examples

- `altova:last-chars("2014-01-15", 5)` returns 01-15
- `altova:last-chars("USA", 10)` returns USA

pad-string-left [altova:]

`altova:pad-string-left(StringToPad as xs:string, StringLength as xs:integer, PadCharacter as xs:string) as xs:string` **XP3.1 XQ3.1**

The `PadCharacter` argument is a single character. It is padded to the left of the string to increase the number of characters in `StringToPad` so that this number equals the integer value of the `StringLength` argument. The `StringLength` argument can have any integer value (positive or negative), but padding will occur only if the value of `StringLength` is greater than the number of characters in `StringToPad`. If `StringToPad` has more characters than the value of `StringLength`, then `StringToPad` is left unchanged.

Examples

- `altova:pad-string-left('AP', 1, 'Z')` returns 'AP'
- `altova:pad-string-left('AP', 2, 'Z')` returns 'AP'
- `altova:pad-string-left('AP', 3, 'Z')` returns 'ZAP'
- `altova:pad-string-left('AP', 4, 'Z')` returns 'ZZAP'
- `altova:pad-string-left('AP', -3, 'Z')` returns 'AP'
- `altova:pad-string-left('AP', 3, 'YZ')` returns a pad-character-too-long error

▼ pad-string-right [altova:]

`altova:pad-string-right(StringToPad as xs:string, StringLength as xs:integer, PadCharacter as xs:string) as xs:string` **XP3.1 XQ3.1**

The `PadCharacter` argument is a single character. It is padded to the right of the string to increase the number of characters in `StringToPad` so that this number equals the integer value of the `StringLength` argument. The `StringLength` argument can have any integer value (positive or negative), but padding will occur only if the value of `StringLength` is greater than the number of characters in `StringToPad`. If `StringToPad` has more characters than the value of `StringLength`, then `StringToPad` is left unchanged.

☐ Examples

- `altova:pad-string-right('AP', 1, 'Z')` returns 'AP'
- `altova:pad-string-right('AP', 2, 'Z')` returns 'AP'
- `altova:pad-string-right('AP', 3, 'Z')` returns 'APZ'
- `altova:pad-string-right('AP', 4, 'Z')` returns 'APZZ'
- `altova:pad-string-right('AP', -3, 'Z')` returns 'AP'
- `altova:pad-string-right('AP', 3, 'YZ')` returns a pad-character-too-long error

▼ repeat-string [altova:]

`altova:repeat-string(InputString as xs:string, Repeats as xs:integer) as xs:string` **XP2 XQ1 XP3.1 XQ3.1**

Generates a string that is composed of the first `InputString` argument repeated `Repeats` number of times.

☐ Examples

- `altova:repeat-string("Altova #", 3)` returns "Altova #Altova #Altova #"

▼ substring-after-last [altova:]

`altova:substring-after-last(MainString as xs:string, CheckString as xs:string) as xs:string` **XP3.1 XQ3.1**

If `CheckString` is found in `MainString`, then the substring that occurs after `CheckString` in `MainString` is returned. If `CheckString` is not found in `MainString`, then the empty string is returned. If `CheckString` is an empty string, then `MainString` is returned in its entirety. If there is more than one occurrence of `CheckString` in `MainString`, then the substring after the last occurrence of `CheckString` is returned.

☐ Examples

- `altova:substring-after-last('ABCDEFGH', 'B')` returns 'CDEFGH'
- `altova:substring-after-last('ABCDEFGH', 'BC')` returns 'DEFGH'
- `altova:substring-after-last('ABCDEFGH', 'BD')` returns ''
- `altova:substring-after-last('ABCDEFGH', 'Z')` returns ''
- `altova:substring-after-last('ABCDEFGH', '')` returns 'ABCDEFGH'
- `altova:substring-after-last('ABCD-ABCD', 'B')` returns 'CD'
- `altova:substring-after-last('ABCD-ABCD-ABCD', 'BCD')` returns ''

▼ substring-before-last [altova:]

`altova:substring-before-last(MainString as xs:string, CheckString as xs:string) as`

xs:string **XP3.1** **XQ3.1**

If `CheckString` is found in `MainString`, then the substring that occurs before `CheckString` in `MainString` is returned. If `CheckString` is not found in `MainString`, or if `CheckString` is an empty string, then the empty string is returned. If there is more than one occurrence of `CheckString` in `MainString`, then the substring before the last occurrence of `CheckString` is returned.

▣ Examples

- `altova:substring-before-last('ABCDEFGH', 'B')` returns 'A'
- `altova:substring-before-last('ABCDEFGH', 'BC')` returns 'A'
- `altova:substring-before-last('ABCDEFGH', 'BD')` returns ''
- `altova:substring-before-last('ABCDEFGH', 'Z')` returns ''
- `altova:substring-before-last('ABCDEFGH', '')` returns ''
- `altova:substring-before-last('ABCD-ABCD', 'B')` returns 'ABCD-A'
- `altova:substring-before-last('ABCD-ABCD-ABCD', 'ABCD')` returns 'ABCD-ABCD-'

▼ `substring-pos` [`altova:`]

`altova:substring-pos(StringToCheck as xs:string, StringToFind as xs:string) as xs:integer` **XP3.1** **XQ3.1**

Returns the character position of the first occurrence of `StringToFind` in the string `StringToCheck`. The character position is returned as an integer. The first character of `StringToCheck` has the position 1. If `StringToFind` does not occur within `StringToCheck`, the integer 0 is returned. To check for the second or a later occurrence of `StringToCheck`, use the next signature of this function.

▣ Examples

- `altova:substring-pos('Altova', 'to')` returns 3
- `altova:substring-pos('Altova', 'tov')` returns 3
- `altova:substring-pos('Altova', 'tv')` returns 0
- `altova:substring-pos('AltovaAltova', 'to')` returns 3

`altova:substring-pos(StringToCheck as xs:string, StringToFind as xs:string, Integer as xs:integer) as xs:integer` **XP3.1** **XQ3.1**

Returns the character position of `StringToFind` in the string, `StringToCheck`. The search for `StringToFind` starts from the character position given by the `Integer` argument; the character substring before this position is not searched. The returned integer, however, is the position of the found string within the *entire* string, `StringToCheck`. This signature is useful for finding the second or a later position of a string that occurs multiple times with the `StringToCheck`. If `StringToFind` does not occur within `StringToCheck`, the integer 0 is returned.

▣ Examples

- `altova:substring-pos('Altova', 'to', 1)` returns 3
- `altova:substring-pos('Altova', 'to', 3)` returns 3
- `altova:substring-pos('Altova', 'to', 4)` returns 0
- `altova:substring-pos('Altova-Altova', 'to', 0)` returns 3
- `altova:substring-pos('Altova-Altova', 'to', 4)` returns 10

▼ `trim-string` [`altova:`]

`altova:trim-string(InputString as xs:string) as xs:string` **XP3.1** **XQ3.1**

This function takes an `xs:string` argument, removes any leading and trailing whitespace, and returns a

"trimmed" `xs:string`.

▣ Examples

- `altova:trim-string(" Hello World ")` returns "Hello World"
- `altova:trim-string("Hello World ")` returns "Hello World"
- `altova:trim-string(" Hello World")` returns "Hello World"
- `altova:trim-string("Hello World")` returns "Hello World"
- `altova:trim-string("Hello World")` returns "Hello World"

▼ trim-string-left [altova:]

`altova:trim-string-left(InputString as xs:string) as xs:string` **XP3.1 XQ3.1**

This function takes an `xs:string` argument, removes any leading whitespace, and returns a left-trimmed `xs:string`.

▣ Examples

- `altova:trim-string-left(" Hello World ")` returns "Hello World "
- `altova:trim-string-left("Hello World ")` returns "Hello World "
- `altova:trim-string-left(" Hello World")` returns "Hello World"
- `altova:trim-string-left("Hello World")` returns "Hello World"
- `altova:trim-string-left("Hello World")` returns "Hello World"

▼ trim-string-right [altova:]

`altova:trim-string-right(InputString as xs:string) as xs:string` **XP3.1 XQ3.1**

This function takes an `xs:string` argument, removes any trailing whitespace, and returns a right-trimmed `xs:string`.

▣ Examples

- `altova:trim-string-right(" Hello World ")` returns " Hello World"
- `altova:trim-string-right("Hello World ")` returns "Hello World"
- `altova:trim-string-right(" Hello World")` returns " Hello World"
- `altova:trim-string-right("Hello World")` returns "Hello World"
- `altova:trim-string-right("Hello World")` returns "Hello World"

27.2.1.9 XPath/XQuery Functions: Miscellaneous

The following general purpose XPath/XQuery extension functions are supported in the current version of XMLSpy and can be used in (i) XPath expressions in an XSLT context, or (ii) XQuery expressions in an XQuery document.

Note about naming of functions and language applicability

Altova extension functions can be used in XPath/XQuery expressions. They provide additional functionality to the functionality that is available in the standard library of XPath, XQuery, and XSLT functions. Altova extension functions are in the **Altova extension functions namespace**, <http://www.altova.com/xslt->

extensions, and are indicated in this section with the prefix **altova:**, which is assumed to be bound to this namespace. Note that, in future versions of your product, support for a function might be discontinued or the behavior of individual functions might change. Consult the documentation of future releases for information about support for Altova extension functions in that release.

| | |
|---|--|
| <i>XPath functions (used in XPath expressions in XSLT):</i> | XP1 XP2 XP3.1 |
| <i>XSLT functions (used in XPath expressions in XSLT):</i> | XSLT1 XSLT2 XSLT3 |
| <i>XQuery functions (used in XQuery expressions in XQuery):</i> | XQ1 XQ3.1 |

▼ decode-string [altova:]

altova:decode-string(Input as *xs:base64Binary*) as *xs:string* **XP3.1** **XQ3.1**

altova:decode-string(Input as *xs:base64Binary*, Encoding as *xs:string*) as *xs:string* **XP3.1** **XQ3.1**

Decodes the submitted base64Binary input to a string using the specified encoding. If no encoding is specified, then the UTF-8 encoding is used. The following encodings are supported: US-ASCII, ISO-8859-1, UTF-16, UTF-16LE, UTF-16BE, ISO-10646-UCS2, UTF-32, UTF-32LE, UTF-32BE, ISO-10646-UCS4

▣ Examples

- **altova:decode-string**(\$XML1/MailData/Meta/b64B) returns the base64Binary input as a UTF-8 encoded string
- **altova:decode-string**(\$XML1/MailData/Meta/b64B, "UTF-8") returns the base64Binary input as a UTF-8-encoded string
- **altova:decode-string**(\$XML1/MailData/Meta/b64B, "ISO-8859-1") returns the base64Binary input as an ISO-8859-1-encoded string

▼ encode-string [altova:]

altova:encode-string(InputString as *xs:string*) as *xs:base64Binaryinteger* **XP3.1** **XQ3.1**

altova:encode-string(InputString as *xs:string*, Encoding as *xs:string*) as *xs:base64Binaryinteger* **XP3.1** **XQ3.1**

Encodes the submitted string using, if one is given, the specified encoding. If no encoding is given, then the UTF-8 encoding is used. The encoded string is converted to base64Binary characters, and the converted base64Binary value is returned. Initially, UTF-8 encoding is supported, and support will be extended to the following encodings: US-ASCII, ISO-8859-1, UTF-16, UTF-16LE, UTF-16BE, ISO-10646-UCS2, UTF-32, UTF-32LE, UTF-32BE, ISO-10646-UCS4

▣ Examples

- **altova:encode-string**("Altova") returns the base64Binary equivalent of the UTF-8 encoded string "Altova"
- **altova:encode-string**("Altova", "UTF-8") returns the base64Binary equivalent of the UTF-8 encoded string "Altova"

▼ get-temp-folder [altova:]

altova:get-temp-folder() as *xs:string* **XP2** **XQ1** **XP3.1** **XQ3.1**

This function takes no argument. It returns the path to the temporary folder of the current user.

▢ Examples

- `altova:get-temp-folder()` would return, on a Windows machine, something like `C:\Users\\AppData\Local\Temp\` as an `xs:string`.

▼ generate-guid [altova:]

`altova:generate-guid()` as `xs:string` **XP2 XQ1 XP3.1 XQ3.1**

Generates a unique string GUID string.

▢ Examples

- `altova:generate-guid()` returns (for example) `85F971DA-17F3-4E4E-994E-99137873ACCD`

▼ high-res-timer [altova:]

`altova:high-res-timer()` as `xs:double` **XP3.1 XQ3.1**

Returns a system high-resolution timer value in seconds. A high-resolution timer, when present on a system, enables high precision time measurements when these are required (for example, in animations and for determining precise code-execution time). This function provides the resolution of the system's high-res timer.

▢ Examples

- `altova:high-res-timer()` returns something like `'1.16766146154566E6'`

▼ parse-html [altova:]

`altova:parse-html(HTMLText as xs:string)` as `node()` **XP3.1 XQ3.1**

The `HTMLText` argument is a string that contains the text of an HTML document. The function creates an HTML tree from the string. The submitted string may or may not contain the HTML element. In either case, the root element of the tree is an element named `HTML`. It is best to make sure that the HTML code in the submitted string is valid HTML.

▢ Examples

- `altova:parse-html("<html><head></body><h1>Header</h1></body></html>")` creates an HTML tree from the submitted string

▼ sleep[altova:]

`altova:sleep(Millisecs as xs:integer)` as `empty-sequence()` **XP2 XQ1 XP3.1 XQ3.1**

Suspends execution of the current operation for the number of milliseconds given by the `Millisecs` argument.

▢ Examples

- `altova:sleep(1000)` suspends execution of the current operation for 1000 milliseconds.

27.2.2 Miscellaneous Extension Functions

There are several ready-made functions in programming languages such as Java and C# that are not available as XQuery/XPath functions or as XSLT functions. A good example would be the math functions available in Java, such as `sin()` and `cos()`. If these functions were available to the designers of XSLT stylesheets and XQuery queries, it would increase the application area of stylesheets and queries and greatly simplify the tasks of stylesheet creators. The XSLT and XQuery engines used in a number of Altova products support the use of extension functions in [Java](#)¹⁶²⁹ and [.NET](#)¹⁶³⁸, as well as [MSXSL scripts for XSLT](#)¹⁶⁴⁴. This section describes how to use extension functions and MSXSL scripts in your XSLT stylesheets and XQuery documents. The available extension functions are organized into the following sections:

- [Java Extension Functions](#)¹⁶²⁹
- [.NET Extension Functions](#)¹⁶³⁸
- [MSXSL Scripts for XSLT](#)¹⁶⁴⁴

The two main issues considered in the descriptions are: (i) how functions in the respective libraries are called; and (ii) what rules are followed for converting arguments in a function call to the required input format of the function, and what rules are followed for the return conversion (function result to XSLT/XQuery data object).

Requirements

For extension functions support, a Java Runtime Environment (for access to Java functions) and .NET Framework 2.0 (minimum, for access to .NET functions) must be installed on the machine running the XSLT transformation or XQuery execution, or must be accessible for the transformations.

27.2.2.1 Java Extension Functions

A Java extension function can be used within an XPath or XQuery expression to invoke a Java constructor or call a Java method (static or instance).

A field in a Java class is considered to be a method without any argument. A field can be static or instance. How to access fields is described in the respective sub-sections, static and instance.

This section is organized into the following sub-sections:

- [Java: Constructors](#)¹⁶³⁴
- [Java: Static Methods and Static Fields](#)¹⁶³⁵
- [Java: Instance Methods and Instance Fields](#)¹⁶³⁶
- [Datatypes: XPath/XQuery to Java](#)¹⁶³⁶
- [Datatypes: Java to XPath/XQuery](#)¹⁶³⁷

Note the following

- If you are using an Altova desktop product, the Altova application attempts to detect the path to the Java virtual machine automatically, by reading (in this order): (i) the Windows registry, and (ii) the `JAVA_HOME` environment variable. You can also add a custom path in the Options dialog of the application; this entry will take priority over any other Java VM path detected automatically.
- If you are running an Altova server product on a Windows machine, the path to the Java virtual machine will be read first from the Windows registry; if this is not successful the `JAVA_HOME` environment variable will be used.

- If you are running an Altova server product on a Linux or macOS machine, then make sure that the `JAVA_HOME` environment variable is properly set and that the Java Virtual Machines library (on Windows, the `jvm.dll` file) can be located in either the `\bin\server` or `\bin\client` directory.

Form of the extension function

The extension function in the XPath/XQuery expression must have the form `prefix:fname()`.

- The `prefix:` part identifies the extension function as a Java function. It does so by associating the extension function with an in-scope namespace declaration, the URI of which must begin with `java:` (see below for examples). The namespace declaration should identify a Java class, for example: `xmlns:myns="java:java.lang.Math"`. However, it could also simply be: `xmlns:myns="java"` (without a colon), with the identification of the Java class being left to the `fname()` part of the extension function.
- The `fname()` part identifies the Java method being called, and supplies the arguments for the method (see below for examples). However, if the namespace URI identified by the `prefix:` part does not identify a Java class (see preceding point), then the Java class should be identified in the `fname()` part, before the class and separated from the class by a period (see the second XSLT example below).

Note: The class being called must be on the classpath of the machine.

XSLT example

Here are two examples of how a static method can be called. In the first example, the class name (`java.lang.Math`) is included in the namespace URI and, therefore, must not be in the `fname()` part. In the second example, the `prefix:` part supplies the prefix `java:` while the `fname()` part identifies the class as well as the method.

```
<xsl:value-of xmlns:jMath="java:java.lang.Math"
  select="jMath:cos(3.14)" />

<xsl:value-of xmlns:jmath="java"
  select="jmath:java.lang.Math.cos(3.14)" />
```

The method named in the extension function (`cos()` in the example above) must match the name of a public static method in the named Java class (`java.lang.Math` in the example above).

XQuery example

Here is an XQuery example similar to the XSLT example above:

```
<cosine xmlns:jMath="java:java.lang.Math">
  {jMath:cos(3.14)}
</cosine>
```

User-defined Java classes

If you have created your own Java classes, methods in these classes are called differently according to: (i) whether the classes are accessed via a JAR file or a class file, and (ii) whether these files (JAR or class) are located in the current directory (the same directory as the XSLT or XQuery document) or not. How to locate these files is described in the sections [User-Defined Class Files](#)¹⁶³¹ and [User-Defined Jar Files](#)¹⁶³³. Note that paths to class files not in the current directory and to all JAR files must be specified.

27.2.2.1.1 User-Defined Class Files

If access is via a class file, then there are four possibilities:

- The class file is in a package. The XSLT or XQuery file is in the same folder as the Java package. ([See example below](#)¹⁶³¹.)
- The class file is not packaged. The XSLT or XQuery file is in the same folder as the class file. ([See example below](#)¹⁶³².)
- The class file is in a package. The XSLT or XQuery file is at some random location. ([See example below](#)¹⁶³².)
- The class file is not packaged. The XSLT or XQuery file is at some random location. ([See example below](#)¹⁶³³.)

Consider the case where the class file is not packaged and is in the same folder as the XSLT or XQuery document. In this case, since all classes in the folder are found, the file location does not need to be specified. The syntax to identify a class is:

```
java:classname
```

where

`java:` indicates that a user-defined Java function is being called; (Java classes in the current directory will be loaded by default)

`classname` is the name of the required method's class

The class is identified in a namespace URI, and the namespace is used to prefix a method call.

Class file packaged, XSLT/XQuery file in same folder as Java package

The example below calls the `getVehicleType()` method of the `Car` class of the `com.altova.extfunc` package. The `com.altova.extfunc` package is in the folder `JavaProject`. The XSLT file is also in the folder `JavaProject`.

```
<xsl:stylesheet version="2.0"
  xmlns:xsl="http://www.w3.org/1999/XSL/Transform"
  xmlns:xs="http://www.w3.org/2001/XMLSchema"
  xmlns:fn="http://www.w3.org/2005/xpath-functions"
  xmlns:car="java:com.altova.extfunc.Car" >
<xsl:output exclude-result-prefixes="fn car xsl fo xs"/>

<xsl:template match="/">
  <a>
    <xsl:value-of select="car:getVehicleType()" />
  </a>
</xsl:template>

</xsl:stylesheet>
```

Class file referenced, XSLT/XQuery file in same folder as class file

The example below calls the `getVehicleType()` method of the `Car` class. Let us say that: (i) the `Car` class file is in the following folder: `JavaProject/com/altova/extfunc`, and (ii) that this folder is the current folder in the example below. The XSLT file is also in the folder `JavaProject/com/altova/extfunc`.

```
<xsl:stylesheet version="2.0"
  xmlns:xsl="http://www.w3.org/1999/XSL/Transform"
  xmlns:xs="http://www.w3.org/2001/XMLSchema"
  xmlns:fn="http://www.w3.org/2005/xpath-functions"
  xmlns:car="java:Car" >
<xsl:output exclude-result-prefixes="fn car xsl fo xs"/>

<xsl:template match="/">
  <a>
    <xsl:value-of select="car:getVehicleType()" />
  </a>
</xsl:template>

</xsl:stylesheet>
```

Class file packaged, XSLT/XQuery file at any location

The example below calls the `getCarColor()` method of the `Car` class of the `com.altova.extfunc` package. The `com.altova.extfunc` package is in the folder `JavaProject`. The XSLT file is at any location. In this case, the location of the package must be specified within the URI as a query string. The syntax is:

```
java:classname[?path=uri-of-package]
```

where

`java:` indicates that a user-defined Java function is being called
`uri-of-package` is the URI of the Java package
`classname` is the name of the required method's class

The class is identified in a namespace URI, and the namespace is used to prefix a method call. The example below shows how to access a class file that is located in another directory than the current directory.

```
<xsl:stylesheet version="2.0"
  xmlns:xsl="http://www.w3.org/1999/XSL/Transform"
  xmlns:xs="http://www.w3.org/2001/XMLSchema"
  xmlns:fn="http://www.w3.org/2005/xpath-functions"
  xmlns:car="java:com.altova.extfunc.Car?path=file:///C:/JavaProject/" >

<xsl:output exclude-result-prefixes="fn car xsl xs"/>

<xsl:template match="/">
  <xsl:variable name="myCar" select="car:new('red') " />
  <a><xsl:value-of select="car:getCarColor($myCar)" /></a>
</xsl:template>
```

```
</xsl:stylesheet>
```

Class file referenced, XSLT/XQuery file at any location

The example below calls the `getCarColor()` method of the `Car` class. Let us say that the `Car` class file is in the folder `C:/JavaProject/com/altova/extfunc`, and the XSLT file is at any location. The location of the class file must then be specified within the namespace URI as a query string. The syntax is:

```
java:classname[?path=<uri-of-classfile>]
```

where

`java:` indicates that a user-defined Java function is being called
`uri-of-classfile` is the URI of the folder containing the class file
`classname` is the name of the required method's class

The class is identified in a namespace URI, and the namespace is used to prefix a method call. The example below shows how to access a class file that is located in another directory than the current directory.

```
<xsl:stylesheet version="2.0"
  xmlns:xsl="http://www.w3.org/1999/XSL/Transform"
  xmlns:xs="http://www.w3.org/2001/XMLSchema"
  xmlns:fn="http://www.w3.org/2005/xpath-functions"
  xmlns:car="java:Car?path=file:///C:/JavaProject/com/altova/extfunc/" >

  <xsl:output exclude-result-prefixes="fn car xsl xs"/>

  <xsl:template match="/">
    <xsl:variable name="myCar" select="car:new('red') " />
    <a><xsl:value-of select="car:getCarColor($myCar)"/></a>
  </xsl:template>

</xsl:stylesheet>
```

Note: When a path is supplied via the extension function, the path is added to the `ClassLoader`.

27.2.2.1.2 User-Defined Jar Files

If access is via a JAR file, the URI of the JAR file must be specified using the following syntax:

```
xmlns:classNS="java:classname?path=jar:uri-of-jarfile!/"
```

The method is then called by using the prefix of the namespace URI that identifies the class:
`classNS:method()`

In the above:

`java:` indicates that a Java function is being called
`classname` is the name of the user-defined class

? is the separator between the classname and the path
 path=jar: indicates that a path to a JAR file is being given
 uri-of-jarfile is the URI of the jar file
 !/ is the end delimiter of the path
 classNS:method() is the call to the method

Alternatively, the classname can be given with the method call. Here are two examples of the syntax:

```
xmlns:ns1="java:docx.layout.pages?path=jar:file:///c:/projects/docs/docx.jar!/"
ns1:main()
```

```
xmlns:ns2="java?path=jar:file:///c:/projects/docs/docx.jar!/"
ns2:docx.layout.pages.main()
```

Here is a complete XSLT example that uses a JAR file to call a Java extension function:

```
<xsl:stylesheet version="2.0"
  xmlns:xsl="http://www.w3.org/1999/XSL/Transform"
  xmlns:xs="http://www.w3.org/2001/XMLSchema"
  xmlns:fn="http://www.w3.org/2005/xpath-functions"
  xmlns:car="java?path=jar:file:///C:/test/Car1.jar!/" >
<xsl:output exclude-result-prefixes="fn car xsl xs"/>

<xsl:template match="/">
  <xsl:variable name="myCar" select="car:Car1.new('red') " />
  <a><xsl:value-of select="car:Car1.getCarColor($myCar)"/></a>
</xsl:template>

<xsl:template match="car"/>

</xsl:stylesheet>
```

Note: When a path is supplied via the extension function, the path is added to the ClassLoader.

27.2.2.1.3 Java: Constructors

An extension function can be used to call a Java constructor. All constructors are called with the pseudo-function `new()`.

If the result of a Java constructor call can be [implicitly converted to XPath/XQuery datatypes](#)¹⁶³⁷, then the Java extension function will return a sequence that is an XPath/XQuery datatype. If the result of a Java constructor call cannot be converted to a suitable XPath/XQuery datatype, then the constructor creates a wrapped Java object with a type that is the name of the class returning that Java object. For example, if a constructor for the class `java.util.Date` is called (`java.util.Date.new()`), then an object having a type `java.util.Date` is returned. The lexical format of the returned object may not match the lexical format of an XPath datatype and the value would therefore need to be converted to the lexical format of the required XPath datatype and then to the required XPath datatype.

There are two things that can be done with a Java object created by a constructor:

- It can be assigned to a variable:

```
<xsl:variable name="currentdate" select="date:new()"
xmlns:date="java:java.util.Date" />
```
- It can be passed to an extension function (see [Instance Method and Instance Fields](#)¹⁶³⁶):

```
<xsl:value-of select="date:toString(date:new())" xmlns:date="java:java.util.Date" />
```

27.2.2.1.4 Java: Static Methods and Static Fields

A static method is called directly by its Java name and by supplying the arguments for the method. Static fields (methods that take no arguments), such as the constant-value fields `E` and `PI`, are accessed without specifying any argument.

XSLT examples

Here are some examples of how static methods and fields can be called:

```
<xsl:value-of xmlns:jMath="java:java.lang.Math"
select="jMath:cos(3.14)" />

<xsl:value-of xmlns:jMath="java:java.lang.Math"
select="jMath:cos(jMath:PI())" />

<xsl:value-of xmlns:jMath="java:java.lang.Math"
select="jMath:E() * jMath:cos(3.14)" />
```

Notice that the extension functions above have the form `prefix:fname()`. The prefix in all three cases is `jMath:`, which is associated with the namespace URI `java:java.lang.Math`. (The namespace URI must begin with `java:.` In the examples above it is extended to contain the class name (`java.lang.Math`.) The `fname()` part of the extension functions must match the name of a public class (e.g. `java.lang.Math`) followed by the name of a public static method with its argument/s (such as `cos(3.14)`) or a public static field (such as `PI()`).

In the examples above, the class name has been included in the namespace URI. If it were not contained in the namespace URI, then it would have to be included in the `fname()` part of the extension function. For example:

```
<xsl:value-of xmlns:java="java:"
select="java:java.lang.Math.cos(3.14)" />
```

XQuery example

A similar example in XQuery would be:

```
<cosine xmlns:jMath="java:java.lang.Math">
  {jMath:cos(3.14)}
</cosine>
```

27.2.2.1.5 Java: Instance Methods and Instance Fields

An instance method has a Java object passed to it as the first argument of the method call. Such a Java object typically would be created by using an extension function (for example a constructor call) or a stylesheet parameter/variable. An XSLT example of this kind would be:

```
<xsl:stylesheet version="1.0" exclude-result-prefixes="date"
  xmlns:xsl="http://www.w3.org/1999/XSL/Transform"
  xmlns:date="java:java.util.Date"
  xmlns:jlang="java:java.lang">
  <xsl:param name="CurrentDate" select="date:new()"/>
  <xsl:template match="/">
    <enrollment institution-id="Altova School"
      date="{date:toString($CurrentDate)}"
      type="{jlang:Object.toString(jlang:Object.getClass( date:new() ))}"
    </enrollment>
  </xsl:template>
</xsl:stylesheet>
```

In the example above, the value of the node `enrollment/@type` is created as follows:

1. An object is created with a constructor for the class `java.util.Date` (with the `date:new()` constructor).
2. This Java object is passed as the argument of the `jlang.Object.getClass` method.
3. The object obtained by the `getClass` method is passed as the argument to the `jlang.Object.toString` method.

The result (the value of `@type`) will be a string having the value: `java.util.Date`.

An instance field is theoretically different from an instance method in that it is not a Java object per se that is passed as an argument to the instance field. Instead, a parameter or variable is passed as the argument. However, the parameter/variable may itself contain the value returned by a Java object. For example, the parameter `CurrentDate` takes the value returned by a constructor for the class `java.util.Date`. This value is then passed as an argument to the instance method `date:toString` in order to supply the value of `/enrollment/@date`.

27.2.2.1.6 Datatypes: XPath/XQuery to Java

When a Java function is called from within an XPath/XQuery expression, the datatype of the function's arguments is important in determining which of multiple Java classes having the same name is called.

In Java, the following rules are followed:

- If there is more than one Java method with the same name, but each has a different number of arguments than the other/s, then the Java method that best matches the number of arguments in the function call is selected.
- The XPath/XQuery string, number, and boolean datatypes (see *list below*) are implicitly converted to a corresponding Java datatype. If the supplied XPath/XQuery type can be converted to more than one Java type (for example, `xs:integer`), then that Java type is selected which is declared for the selected

method. For example, if the Java method being called is `fx(decimal)` and the supplied XPath/XQuery datatype is `xs:integer`, then `xs:integer` will be converted to Java's `decimal` datatype.

The table below lists the implicit conversions of XPath/XQuery string, number, and boolean types to Java datatypes.

| | |
|-------------------------|---|
| <code>xs:string</code> | <code>java.lang.String</code> |
| <code>xs:boolean</code> | <code>boolean (primitive)</code> , <code>java.lang.Boolean</code> |
| <code>xs:integer</code> | <code>int</code> , <code>long</code> , <code>short</code> , <code>byte</code> , <code>float</code> , <code>double</code> , and the wrapper classes of these, such as <code>java.lang.Integer</code> |
| <code>xs:float</code> | <code>float (primitive)</code> , <code>java.lang.Float</code> , <code>double (primitive)</code> |
| <code>xs:double</code> | <code>double (primitive)</code> , <code>java.lang.Double</code> |
| <code>xs:decimal</code> | <code>float (primitive)</code> , <code>java.lang.Float</code> , <code>double(primitive)</code> , <code>java.lang.Double</code> |

Subtypes of the XML Schema datatypes listed above (and which are used in XPath and XQuery) will also be converted to the Java type/s corresponding to that subtype's ancestor type.

In some cases, it might not be possible to select the correct Java method based on the supplied information. For example, consider the following case.

- The supplied argument is an `xs:untypedAtomic` value of 10 and it is intended for the method `mymethod(float)`.
- However, there is another method in the class which takes an argument of another datatype: `mymethod(double)`.
- Since the method names are the same and the supplied type (`xs:untypedAtomic`) could be converted correctly to either `float` or `double`, it is possible that `xs:untypedAtomic` is converted to `double` instead of `float`.
- Consequently the method selected will not be the required method and might not produce the expected result. To work around this, you can create a user-defined method with a different name and use this method.

Types that are not covered in the list above (for example `xs:date`) will not be converted and will generate an error. However, note that in some cases, it might be possible to create the required Java type by using a Java constructor.

27.2.2.1.7 Datatypes: Java to XPath/XQuery

When a Java method returns a value, the datatype of the value is a string, numeric or boolean type, then it is converted to the corresponding XPath/XQuery type. For example, Java's `java.lang.Boolean` and `boolean` datatypes are converted to `xsd:boolean`.

One-dimensional arrays returned by functions are expanded to a sequence. Multi-dimensional arrays will not be converted, and should therefore be wrapped.

When a wrapped Java object or a datatype other than string, numeric or boolean is returned, you can ensure conversion to the required XPath/XQuery type by first using a Java method (e.g. `toString`) to convert the Java object to a string. In XPath/XQuery, the string can be modified to fit the lexical representation of the required type and then converted to the required type (for example, by using the `cast as` expression).

27.2.2.2 .NET Extension Functions

If you are working on the .NET platform on a Windows machine, you can use extension functions written in any of the .NET languages (for example, C#). A .NET extension function can be used within an XPath or XQuery expression to invoke a constructor, property, or method (static or instance) within a .NET class.

A property of a .NET class is called using the syntax `get_PropertyName()`.

This section is organized into the following sub-sections:

- [.NET: Constructors](#) ¹⁶⁴⁰
- [.NET: Static Methods and Static Fields](#) ¹⁶⁴¹
- [.NET: Instance Methods and Instance Fields](#) ¹⁶⁴¹
- [Datatypes: XPath/XQuery to .NET](#) ¹⁶⁴²
- [Datatypes: .NET to XPath/XQuery](#) ¹⁶⁴³

Form of the extension function

The extension function in the XPath/XQuery expression must have the form `prefix:fname()`.

- The `prefix:` part is associated with a URI that identifies the .NET class being addressed.
- The `fname()` part identifies the constructor, property, or method (static or instance) within the .NET class, and supplies any argument/s, if required.
- The URI must begin with `clitype:` (which identifies the function as being a .NET extension function).
- The `prefix:fname()` form of the extension function can be used with system classes and with classes in a loaded assembly. However, if a class needs to be loaded, additional parameters containing the required information will have to be supplied.

Parameters

To load an assembly, the following parameters are used:

| | |
|--------------------------|---|
| <code>asm</code> | The name of the assembly to be loaded. |
| <code>ver</code> | The version number (maximum of four integers separated by periods). |
| <code>sn</code> | The key token of the assembly's strong name (16 hex digits). |
| <code>from</code> | A URI that gives the location of the assembly (DLL) to be loaded. If the URI is relative, it is relative to the XSLT or XQuery document. If this parameter is present, any other parameter is ignored. |
| <code>partialname</code> | The partial name of the assembly. It is supplied to <code>Assembly.LoadWith.PartialName()</code> , which will attempt to load the assembly. If <code>partialname</code> is present, any other parameter is ignored. |

`loc` The locale, for example, `en-US`. The default is `neutral`.

If the assembly is to be loaded from a DLL, use the `from` parameter and omit the `sn` parameter. If the assembly is to be loaded from the Global Assembly Cache (GAC), use the `sn` parameter and omit the `from` parameter.

A question mark must be inserted before the first parameter, and parameters must be separated by a semi-colon. The parameter name gives its value with an equals sign (*see example below*).

Examples of namespace declarations

An example of a namespace declaration in XSLT that identifies the system class `System.Environment`:

```
xmlns:myns="clitype:System.Environment"
```

An example of a namespace declaration in XSLT that identifies the class to be loaded as `Trade.Forward.Scrip`:

```
xmlns:myns="clitype:Trade.Forward.Scrip?asm=forward;version=10.6.2.1"
```

An example of a namespace declaration in XQuery that identifies the system class `MyManagedDLL.testClass`. Two cases are distinguished:

1. When the assembly is loaded from the GAC:

```
declare namespace cs="clitype:MyManagedDLL.testClass?asm=MyManagedDLL;
ver=1.2.3.4;loc=neutral;sn=b9f091b72dccfba8";
```

2. When the assembly is loaded from the DLL (complete and partial references below):

```
declare namespace cs="clitype:MyManagedDLL.testClass?from=file:///C:/Altova
Projects/extFunctions/MyManagedDLL.dll;
```

```
declare namespace cs="clitype:MyManagedDLL.testClass?from=MyManagedDLL.dll;
```

XSLT example

Here is a complete XSLT example that calls functions in system class `System.Math`:

```
<xsl:stylesheet version="2.0"
  xmlns:xsl="http://www.w3.org/1999/XSL/Transform"
  xmlns:xs="http://www.w3.org/2001/XMLSchema"
  xmlns:fn="http://www.w3.org/2005/xpath-functions">
  <xsl:output method="xml" omit-xml-declaration="yes" />
  <xsl:template match="/">
    <math xmlns:math="clitype:System.Math">
      <sqrt><xsl:value-of select="math:Sqrt(9)"/></sqrt>
      <pi><xsl:value-of select="math:PI()"/></pi>
      <e><xsl:value-of select="math:E()"/></e>
      <pow><xsl:value-of select="math:Pow(math:PI(), math:E())"/></pow>
    </math>
  </xsl:template>
</xsl:stylesheet>
```

The namespace declaration on the element `math` associates the prefix `math:` with the URI `clitype:System.Math`. The `clitype:` beginning of the URI indicates that what follows identifies either a system class or a loaded class. The `math:` prefix in the XPath expressions associates the extension functions with the URI (and, by extension, the class) `System.Math`. The extension functions identify methods in the class `System.Math` and supply arguments where required.

XQuery example

Here is an XQuery example fragment similar to the XSLT example above:

```
<math xmlns:math="clitype:System.Math">
  {math:Sqrt(9)}
</math>
```

As with the XSLT example above, the namespace declaration identifies the .NET class, in this case a system class. The XQuery expression identifies the method to be called and supplies the argument.

27.2.2.2.1 .NET: Constructors

An extension function can be used to call a .NET constructor. All constructors are called with the pseudo-function `new()`. If there is more than one constructor for a class, then the constructor that most closely matches the number of arguments supplied is selected. If no constructor is deemed to match the supplied argument/s, then a 'No constructor found' error is returned.

Constructors that return XPath/XQuery datatypes

If the result of a .NET constructor call can be [implicitly converted to XPath/XQuery datatypes](#) ¹⁶³⁷, then the .NET extension function will return a sequence that is an XPath/XQuery datatype.

Constructors that return .NET objects

If the result of a .NET constructor call cannot be converted to a suitable XPath/XQuery datatype, then the constructor creates a wrapped .NET object with a type that is the name of the class returning that object. For example, if a constructor for the class `System.DateTime` is called (with `System.DateTime.new()`), then an object having a type `System.DateTime` is returned.

The lexical format of the returned object may not match the lexical format of a required XPath datatype. In such cases, the returned value would need to be: (i) converted to the lexical format of the required XPath datatype; and (ii) cast to the required XPath datatype.

There are three things that can be done with a .NET object created by a constructor:

- It can be used within a variable:

```
<xsl:variable name="currentdate" select="date:new(2008, 4, 29)"
  xmlns:date="clitype:System.DateTime" />
```
- It can be passed to an extension function (see [Instance Method and Instance Fields](#) ¹⁶³⁸):

```
<xsl:value-of select="date:ToString(date:new(2008, 4, 29))"
  xmlns:date="clitype:System.DateTime" />
```
- It can be converted to a string, number, or boolean:

- `<xsl:value-of select="xs:integer(date:get_Month(date:new(2008, 4, 29)))" xmlns:date="clitype:System.DateTime" />`

27.2.2.2.2 .NET: Static Methods and Static Fields

A static method is called directly by its name and by supplying the arguments for the method. The name used in the call must exactly match a public static method in the class specified. If the method name and the number of arguments that were given in the function call matches more than one method in a class, then the types of the supplied arguments are evaluated for the best match. If a match cannot be found unambiguously, an error is reported.

Note: A field in a .NET class is considered to be a method without any argument. A property is called using the syntax `get_PropertyName()`.

Examples

An XSLT example showing a call to a method with one argument (`System.Math.Sin(arg)`):

```
<xsl:value-of select="math:Sin(30)" xmlns:math="clitype:System.Math"/>
```

An XSLT example showing a call to a field (considered a method with no argument)

```
(System.Double.MaxValue());
```

```
<xsl:value-of select="double:MaxValue()" xmlns:double="clitype:System.Double"/>
```

An XSLT example showing a call to a property (syntax is `get_PropertyName()`) (`System.String()`):

```
<xsl:value-of select="string:get_Length('my string')"
xmlns:string="clitype:System.String"/>
```

An XQuery example showing a call to a method with one argument (`System.Math.Sin(arg)`):

```
<sin xmlns:math="clitype:System.Math">
  { math:Sin(30) }
</sin>
```

27.2.2.2.3 .NET: Instance Methods and Instance Fields

An instance method has a .NET object passed to it as the first argument of the method call. This .NET object typically would be created by using an extension function (for example a constructor call) or a stylesheet parameter/variable. An XSLT example of this kind would be:

```
<xsl:stylesheet version="2.0"
  xmlns:xsl="http://www.w3.org/1999/XSL/Transform"
  xmlns:xs="http://www.w3.org/2001/XMLSchema"
  xmlns:fn="http://www.w3.org/2005/xpath-functions">
  <xsl:output method="xml" omit-xml-declaration="yes"/>
  <xsl:template match="/">
    <xsl:variable name="releasedate"
      select="date:new(2008, 4, 29)"
```

```

    xmlns:date="clitype:System.DateTime"/>
<doc>
  <date>
    <xsl:value-of select="date:ToString(date:new(2008, 4, 29))"
      xmlns:date="clitype:System.DateTime"/>
  </date>
  <date>
    <xsl:value-of select="date:ToString($releasedate)"
      xmlns:date="clitype:System.DateTime"/>
  </date>
</doc>
</xsl:template>
</xsl:stylesheet>

```

In the example above, a `System.DateTime` constructor (`new(2008, 4, 29)`) is used to create a .NET object of type `System.DateTime`. This object is created twice, once as the value of the variable `releasedate`, a second time as the first and only argument of the `System.DateTime.ToString()` method. The instance method `System.DateTime.ToString()` is called twice, both times with the `System.DateTime` constructor (`new(2008, 4, 29)`) as its first and only argument. In one of these instances, the variable `releasedate` is used to get the .NET object.

Instance methods and instance fields

The difference between an instance method and an instance field is theoretical. In an instance method, a .NET object is directly passed as an argument; in an instance field, a parameter or variable is passed instead—though the parameter or variable may itself contain a .NET object. For example, in the example above, the variable `releasedate` contains a .NET object, and it is this variable that is passed as the argument of `ToString()` in the second `date` element constructor. Therefore, the `ToString()` instance in the first `date` element is an instance method while the second is considered to be an instance field. The result produced in both instances, however, is the same.

27.2.2.2.4 Datatypes: XPath/XQuery to .NET

When a .NET extension function is used within an XPath/XQuery expression, the datatypes of the function's arguments are important for determining which one of multiple .NET methods having the same name is called.

In .NET, the following rules are followed:

- If there is more than one method with the same name in a class, then the methods available for selection are reduced to those that have the same number of arguments as the function call.
- The XPath/XQuery string, number, and boolean datatypes (see *list below*) are implicitly converted to a corresponding .NET datatype. If the supplied XPath/XQuery type can be converted to more than one .NET type (for example, `xs:integer`), then that .NET type is selected which is declared for the selected method. For example, if the .NET method being called is `fx(double)` and the supplied XPath/XQuery datatype is `xs:integer`, then `xs:integer` will be converted to .NET's `double` datatype.

The table below lists the implicit conversions of XPath/XQuery string, number, and boolean types to .NET datatypes.

| | |
|-------------------------|---|
| <code>xs:string</code> | <code>StringValue, string</code> |
| <code>xs:boolean</code> | <code>BooleanValue, bool</code> |
| <code>xs:integer</code> | <code>IntegerValue, decimal, long, integer, short, byte, double, float</code> |
| <code>xs:float</code> | <code>FloatValue, float, double</code> |
| <code>xs:double</code> | <code>DoubleValue, double</code> |
| <code>xs:decimal</code> | <code>DecimalValue, decimal, double, float</code> |

Subtypes of the XML Schema datatypes listed above (and which are used in XPath and XQuery) will also be converted to the .NET type/s corresponding to that subtype's ancestor type.

In some cases, it might not be possible to select the correct .NET method based on the supplied information. For example, consider the following case.

- The supplied argument is an `xs:untypedAtomic` value of 10 and it is intended for the method `mymethod(float)`.
- However, there is another method in the class which takes an argument of another datatype: `mymethod(double)`.
- Since the method names are the same and the supplied type (`xs:untypedAtomic`) could be converted correctly to either `float` or `double`, it is possible that `xs:untypedAtomic` is converted to `double` instead of `float`.
- Consequently the method selected will not be the required method and might not produce the expected result. To work around this, you can create a user-defined method with a different name and use this method.

Types that are not covered in the list above (for example `xs:date`) will not be converted and will generate an error.

27.2.2.2.5 Datatypes: .NET to XPath/XQuery

When a .NET method returns a value and the datatype of the value is a string, numeric or boolean type, then it is converted to the corresponding XPath/XQuery type. For example, .NET's `decimal` datatype is converted to `xsd:decimal`.

When a .NET object or a datatype other than string, numeric or boolean is returned, you can ensure conversion to the required XPath/XQuery type by first using a .NET method (for example `System.DateTime.ToString()`) to convert the .NET object to a string. In XPath/XQuery, the string can be modified to fit the lexical representation of the required type and then converted to the required type (for example, by using the `cast as` expression).

27.2.2.3 MSXSL Scripts for XSLT

The `<msxsl:script>` element contains user-defined functions and variables that can be called from within XPath expressions in the XSLT stylesheet. The `<msxsl:script>` is a top-level element, that is, it must be a child element of `<xsl:stylesheet>` or `<xsl:transform>`.

The `<msxsl:script>` element must be in the namespace `urn:schemas-microsoft-com:xslt` (see example below).

Scripting language and namespace

The scripting language used within the block is specified in the `<msxsl:script>` element's `language` attribute and the namespace to be used for function calls from XPath expressions is identified with the `implements-prefix` attribute (see below).

```
<msxsl:script language="scripting-language" implements-prefix="user-namespace-prefix">
    function-1 or variable-1
    ...
    function-n or variable-n
</msxsl:script>
```

The `<msxsl:script>` element interacts with the Windows Scripting Runtime, so only languages that are installed on your machine may be used within the `<msxsl:script>` element. **The .NET Framework 2.0 platform or higher must be installed for MSXSL scripts to be used.** Consequently, the .NET scripting languages can be used within the `<msxsl:script>` element.

The `language` attribute accepts the same values as the `language` attribute on the HTML `<script>` element. If the `language` attribute is not specified, then Microsoft JScript is assumed as the default.

The `implements-prefix` attribute takes a value that is a prefix of a declared in-scope namespace. This namespace typically will be a user namespace that has been reserved for a function library. All functions and variables defined within the `<msxsl:script>` element will be in the namespace identified by the prefix specified in the `implements-prefix` attribute. When a function is called from within an XPath expression, the fully qualified function name must be in the same namespace as the function definition.

Example

Here is an example of a complete XSLT stylesheet that uses a function defined within a `<msxsl:script>` element.

```
<?xml version="1.0" encoding="UTF-8"?>
<xsl:stylesheet version="2.0" xmlns:xsl="http://www.w3.org/1999/XSL/Transform"
  xmlns:xs="http://www.w3.org/2001/XMLSchema"
  xmlns:fn="http://www.w3.org/2005/xpath-functions"
  xmlns:msxsl="urn:schemas-microsoft-com:xslt"
  xmlns:user="http://mycompany.com/mynamespace">

  <msxsl:script language="VBScript" implements-prefix="user">
    <![CDATA[
      ' Input: A currency value: the wholesale price
```



```

' Returns: The retail price: the input value plus 20% margin,
' rounded to the nearest cent
dim a as integer = 13
Function AddMargin(WholesalePrice) as integer
    AddMargin = WholesalePrice * 1.2 + a
End Function
]]>
</msxsl:script>

<xsl:template match="/">
  <html>
    <body>
      <p>
        <b>Total Retail Price =
          $<xsl:value-of select="user:AddMargin(50)"/>
        </b>
        <br/>
        <b>Total Wholesale Price =
          $<xsl:value-of select="50"/>
        </b>
      </p>
    </body>
  </html>
</xsl:template>
</xsl:stylesheet>

```

Datatypes

The values of parameters passed into and out of the script block are limited to XPath datatypes. This restriction does not apply to data passed among functions and variables within the script block.

Assemblies

An assembly can be imported into the script by using the `msxsl:assembly` element. The assembly is identified via a name or a URI. The assembly is imported when the stylesheet is compiled. Here is a simple representation of how the `msxsl:assembly` element is to be used.

```

<msxsl:script>
  <msxsl:assembly name="myAssembly.assemblyName" />
  <msxsl:assembly href="pathToAssembly" />
  ...
</msxsl:script>

```

The assembly name can be a full name, such as:

```
"system.Math, Version=3.1.4500.1 Culture=neutral PublicKeyToken=a46b3f648229c514"
```

or a short name, such as "myAssembly.Draw".

Namespaces

Namespaces can be declared with the `msxsl:using` element. This enables assembly classes to be written in the script without their namespaces, thus saving you some tedious typing. Here is how the `msxsl:using` element is used so as to declare namespaces.

```
<msxsl:script>
  <msxsl:using namespace="myAssemblyNS.NamespaceName" />

  ...

</msxsl:script>
```

The value of the `namespace` attribute is the name of the namespace.

27.3 Datatypes in DB-Generated XML Schemas

When an XML Schema is generated from a database (DB), the datatypes specific to that DB are converted to XML Schema datatypes. The mappings of DB datatypes to XML Schema datatypes for commonly used DBs are given in this Appendix. Select from the list below.

- [ADO](#)¹⁶⁴⁷
- [MS Access](#)¹⁶⁴⁸
- [MS SQL Server](#)¹⁶⁴⁹
- [MySQL](#)¹⁶⁴⁹
- [ODBC](#)¹⁶⁵⁰
- [Oracle](#)¹⁶⁵¹
- [Sybase](#)¹⁶⁵²

27.3.1 ADO

When an XML Schema is generated from an ADO database (DB), the ADO DB datatypes are converted to XML Schema datatypes as listed in the table below.

| ADO Datatype | XML Schema Datatype |
|----------------|---------------------|
| adGUID | xs:ID |
| adChar | xs:string |
| adWChar | xs:string |
| adVarChar | xs:string |
| adWVarChar | xs:string |
| adLongVarChar | xs:string |
| adWLongVarChar | xs:string |
| adVarWChar | xs:string |
| adBoolean | xs:boolean |
| adSingle | xs:float |
| adDouble | xs:double |
| adNumeric | xs:decimal |
| adCurrency | xs:decimal |
| adDBTimeStamp | xs:dateTime |
| adDate | xs:date |
| adBinary | xs:base64Binary |
| adVarBinary | xs:base64Binary |

| | |
|--------------------|------------------|
| adLongVarBinary | xs:base64Binary |
| adInteger | xs:Integer |
| adUnsignedInt | xs:unsignedInt |
| adSmallInt | xs:short |
| adUnsignedSmallInt | xs:unsignedShort |
| adBigInt | xs:long |
| adUnsignedBigInt | xs:unsignedLong |
| adTinyInt | xs:byte |
| adUnsignedTinyInt | xs:unsignedByte |

27.3.2 MS Access

When an XML Schema is generated from an MS Access database (DB), the MS Access DB datatypes are converted to XML Schema datatypes as listed in the table below.

| MS Access Datatype | XML Schema Datatype |
|----------------------|---------------------|
| GUID | xs:ID |
| char | xs:string |
| varchar | xs:string |
| memo | xs:string |
| bit | xs:boolean |
| Number(single) | xs:float |
| Number(double) | xs:double |
| Decimal | xs:decimal |
| Currency | xs:decimal |
| Date/Time | xs:dateTime |
| Number(Long Integer) | xs:integer |
| Number(Integer) | xs:short |
| Number(Byte) | xs:byte |
| OLE Object | xs:base64Binary |

27.3.3 MS SQL Server

When an XML Schema is generated from an MS SQL Server database (DB), the MS SQL Server DB datatypes are converted to XML Schema datatypes as listed in the table below.

| MS SQL Server Datatype | XML Schema Datatype |
|------------------------|---------------------|
| uniqueidentifier | xs:ID |
| char | xs:string |
| nchar | xs:string |
| varchar | xs:string |
| nvarchar | xs:string |
| text | xs:string |
| ntext | xs:string |
| sysname | xs:string |
| bit | xs:boolean |
| real | xs:float |
| float | xs:double |
| decimal | xs:decimal |
| money | xs:decimal |
| smallmoney | xs:decimal |
| datetime | xs:dateTime |
| smalldatetime | xs:dateTime |
| binary | xs:base64Binary |
| varbinary | xs:base64Binary |
| image | xs:base64Binary |
| integer | xs:integer |
| smallint | xs:short |
| bigint | xs:long |
| tinyint | xs:byte |

27.3.4 MySQL

When an XML Schema is generated from a MySQL database (DB), the MySQL DB datatypes are converted to XML Schema datatypes as listed in the table below.

| MySQL Datatype | XML Schema Datatype |
|----------------|---------------------|
| char | xs:string |
| varchar | xs:string |
| text | xs:string |
| tinytext | xs:string |
| mediumtext | xs:string |
| longtext | xs:string |
| tinyint(1) | xs:boolean |
| float | xs:float |
| double | xs:double |
| decimal | xs:decimal |
| datetime | xs:dateTime |
| blob | xs:base64Binary |
| tinyblob | xs:base64Binary |
| mediumblob | xs:base64Binary |
| longblob | xs:base64Binary |
| smallint | xs:short |
| bigint | xs:long |
| tinyint | xs:byte |

27.3.5 ODBC

When an XML Schema is generated from an ODBC database (DB), the ODBC DB datatypes are converted to XML Schema datatypes as listed in the table below.

| ODBC Datatype | XML Schema Datatype |
|-----------------|---------------------|
| SQL_GUID | xs:ID |
| SQL_CHAR | xs:string |
| SQL_VARCHAR | xs:string |
| SQL_LONGVARCHAR | xs:string |
| SQL_BIT | xs:boolean |
| SQL_REAL | xs:float |

| | |
|-------------------|-----------------|
| SQL_DOUBLE | xs:double |
| SQL_DECIMAL | xs:decimal |
| SQL_TIMESTAMP | xs:dateTime |
| SQL_DATE | xs:date |
| SQL_BINARY | xs:base64Binary |
| SQL_VARBINARY | xs:base64Binary |
| SQL_LONGVARBINARY | xs:base64Binary |
| SQL_INTEGER | xs:integer |
| SQL_SMALLINT | xs:short |
| SQL_BIGINT | xs:long |
| SQL_TINYINT | xs:byte |

27.3.6 Oracle

When an XML Schema is generated from an Oracle database (DB), the Oracle DB datatypes are converted to XML Schema datatypes as listed in the table below.

| Oracle Datatype | XML Schema Datatype |
|---|---------------------|
| ROWID | xs:ID |
| CHAR | xs:string |
| NCHAR | xs:string |
| VARCHAR2 | xs:string |
| NVARCHAR2 | xs:string |
| CLOB | xs:string |
| NCLOB | xs:string |
| NUMBER (with check constraint applied)* | xs:boolean |
| NUMBER | xs:decimal |
| FLOAT | xs:double |
| DATE | xs:dateTime |
| INTERVAL YEAR TO MONTH | xs:gYearMonth |
| BLOB | xs:base64Binary |

* If a check constraint is applied to a column of datatype NUMBER, and the check constraint checks for

the values 0 or 1, then the `NUMBER` datatype for this column will be converted to an XML Schema datatype of `xs:boolean`. This mechanism is useful for generating an `xs:boolean` datatype in the generated XML Schema.

27.3.7 Sybase

When an XML Schema is generated from a Sybase database (DB), the Sybase DB datatypes are converted to XML Schema datatypes as listed in the table below.

| Sybase Datatype | XML Schema Datatype |
|---------------------|---------------------|
| char | xs:string |
| nchar | xs:string |
| varchar | xs:string |
| nvarchar | xs:string |
| text | xs:string |
| sysname-varchar(30) | xs:string |
| bit | xs:boolean |
| real | xs:float |
| float | xs:float |
| double | xs:double |
| decimal | xs:decimal |
| money | xs:decimal |
| smallmoney | xs:decimal |
| datetime | xs:dateTime |
| smalldatetime | xs:dateTime |
| timestamp | xs:dateTime |
| binary<=255 | xs:base64Binary |
| varbinary<=255 | xs:base64Binary |
| image | xs:base64Binary |
| integer | xs:integer |
| smallint | xs:short |
| tinyint | xs:byte |

27.4 Datatypes in DBs Generated from XML Schemas

When a DB structure is created from an XML Schema, the datatypes specific to that DB are generated from XML Schema datatypes. The mappings of XML Schema datatypes to DB datatypes for commonly used DBs are given in this Appendix. Select from the list below.

- [MS Access](#)¹⁶⁵³
- [MS SQL Server](#)¹⁶⁵⁴
- [MySQL](#)¹⁶⁵⁶
- [Oracle](#)¹⁶⁵⁸

27.4.1 MS Access

When an MS Access database (DB) is created from an XML Schema, the XML Schema datatypes are converted to MS Access datatypes as listed in the table below.

| XML Schema Datatype | MS Access Datatype |
|---------------------|-----------------------------------|
| xs:ID | GUID |
| xs:string | If no facets varchar (255) |
| | Size = either length or maxLength |
| | If Size <= 255 varchar (n) |
| | else memo |
| xs:normalizedString | Same as xs:string |
| xs:token | Same as xs:string |
| xs:Name | Same as xs:string |
| xs:NCName | Same as xs:string |
| xs:anyURI | Same as xs:string |
| xs:QName | Same as xs:string |
| xs:NOTATION | Same as xs:string |
| xs:boolean | bit |
| xs:float | Number (single) |
| xs:double | Number (double) |
| xs:decimal | Decimal |
| xs:duration | Date/Time |
| xs:dateTime | Date/Time |

| | |
|-----------------------|---|
| xs:time | Date/Time |
| xs:date | Date/Time |
| xs:gYearMonth | Date/Time |
| xs:gYear | Date/Time |
| xs:gMonthDay | Date/Time |
| xs:gDay | Date/Time |
| xs:gMonth | Date/Time |
| xs:hexBinary | If no facets varbinary (255) |
| | Size = either length or maxLength |
| | If Size <= 8000 varbinary |
| | else image (OLE Object) |
| xs:base64Binary | Same as xs:hexBinary |
| xs:integer | Number (Long Integer) |
| xs:int | Number (Long Integer) |
| xs:negativeInteger | Number (Long Integer); value constraint |
| xs:positiveInteger | Number (Long Integer); value constraint |
| xs:nonNegativeInteger | Number (Long Integer); value constraint |
| xs:nonPositiveInteger | Number (Long Integer); value constraint |
| xs:unsignedInt | Number (Long Integer) |
| xs:short | -- no equivalent -- |
| xs:unsignedShort | -- no equivalent -- |
| xs:long | -- no equivalent -- |
| xs:unsignedLong | -- no equivalent -- |
| xs:byte | Number (Byte) |
| xs:unsignedByte | Number (Byte) |

27.4.2 MS SQL Server

When an XML Schema is generated from an MS SQL Server database (DB), the MS SQL Server DB datatypes are converted to XML Schema datatypes as listed in the table below.

| XML Schema Datatype | MS SQL Server Datatype |
|---------------------|------------------------|
| ID | uniqueidentifier |

| | |
|---------------------|-------------------------------------|
| xs:string | If no facets |
| | { if UNICODE nvarchar (255) |
| | else varchar (255) } |
| | else |
| | { if UNICODE |
| | (Size = either length or maxLength) |
| | If Size <= 4000 |
| | if FacetLengthIsSet then nChar |
| | else nVarChar |
| | if Size <= 1073741823 then nText } |
| | else |
| | { if NON-UNICODE |
| | (Size = either length or maxLength) |
| | If Size <= 8000 |
| | if FacetLengthIsSet then char |
| | else varchar |
| | if Size <= 2147483647 then text } |
| xs:normalizedString | Same as xs:string |
| xs:token | Same as xs:string |
| xs:Name | Same as xs:string |
| xs:NCName | Same as xs:string |
| xs:anyURI | Same as xs:string |
| xs:QName | Same as xs:string |
| xs:NOTATION | Same as xs:string |
| xs:boolean | bit |
| xs:float | real |
| xs:double | float |
| xs:decimal | decimal |
| xs:duration | datetime |
| xs:dateTime | datetime |
| xs:time | datetime |
| xs:date | datetime |

| | |
|-----------------------|------------------------------------|
| xs:gYearMonth | datetime |
| xs:gYear | datetime |
| xs:gMonthDay | datetime |
| xs:gDay | datetime |
| xs:gMonth | datetime |
| xs:hexBinary | If no facets varbinary (255) |
| | (Size = either length or maxLength |
| | If Size <= 8000 |
| | if FacetLengthIsSet then binary |
| | else varbinary |
| | if Size <= 2147483647 then image |
| xs:base64Binary | Same as xs:hexBinary |
| xs:integer | int |
| xs:int | int |
| xs:negativeInteger | Int (constrained to {...,-2,-1}) |
| xs:positiveInteger | Int (constrained to {1,2,...}) |
| xs:nonNegativeInteger | int (constrained to {0,1,2,...}) |
| xs:nonPositiveInteger | int (constrained to {...,-2,-1,0}) |
| xs:unsignedInt | int (additional constraints) |
| xs:short | smallint |
| xs:unsignedShort | smallint (additional constraints) |
| xs:long | bigint |
| xs:unsignedLong | bigint (additional constraints) |
| xs:byte | tinyint |
| xs:unsignedByte | tinyint (additional constraints) |

27.4.3 MySQL

When an XML Schema is generated from a MySQL database (DB), the MySQL DB datatypes are converted to XML Schema datatypes as listed in the table below.

| XML Schema Datatype | MySQL Datatype |
|---------------------|----------------|
| xs:ID | varchar(255) |

| | |
|---------------------|--|
| xs:string | If no facets then varchar (255) |
| | else if facet length is set and <= 255 then char |
| | else if facet maxLength set and <= 255 then varchar |
| | else if maxLength is set and <= 65545 then text |
| | else if maxlength is set and <= 16777215 then mediumtext |
| | else if maxlength is set and <= 429496295 then longtext |
| xs:normalizedString | Same as xs:string |
| xs:token | Same as xs:string |
| xs:Name | Same as xs:string |
| xs:NCName | Same as xs:string |
| xs:anyURI | Same as xs:string |
| xs:QName | Same as xs:string |
| xs:NOTATION | Same as xs:string |
| xs:boolean | tinyint(1) |
| xs:float | float |
| xs:double | double |
| xs:decimal | decimal |
| xs:duration | timestamp |
| xs:dateTime | datetime |
| xs:time | time |
| xs:date | date |
| xs:gYearMonth | timestamp(4) |
| xs:gYear | year(4) |
| xs:gMonthDay | timestamp(8); constraints to check month, day |
| xs:gDay | timestamp(8); constraints to check day |
| xs:gMonth | timestamp(8); constraints to check month |
| xs:hexBinary | If no facets then blob (255) |
| | else if facet length is set and <= 255 then blob |

| | |
|-----------------------|---|
| | else if facet maxLength is set and <= 255
then tinyblob |
| | else if maxLength is set and <= 65545
then blob |
| | else if maxLength is set and <= 16777215
then mediumblob |
| | else if maxLength is set and <= 429496295
then longblob |
| xs:base64Binary | Same as xs:hexBinary |
| xs:integer | Integer |
| xs:int | int |
| xs:negativeInteger | Integer (constrained to {...,-2,-1}) |
| xs:positiveInteger | Integer (constrained to {1,2,...}) |
| xs:nonNegativeInteger | Integer (constrained to {0,1,2,...}) |
| xs:nonPositiveInteger | Integer (constrained to {...,-2,-1,0}) |
| xs:unsignedInt | Int (additional constraints) |
| xs:short | Smallint |
| xs:unsignedShort | Smallint (additional constraints) |
| xs:long | Bigint |
| xs:unsignedLong | Bigint (additional constraints) |
| xs:byte | Tinyint |
| xs:unsignedByte | Tinyint (additional constraints) |

27.4.4 Oracle

When an XML Schema is generated from an Oracle database (DB), the Oracle DB datatypes are converted to XML Schema datatypes as listed in the table below.

| XML Schema Datatype | Oracle Datatype |
|---------------------|-------------------------------------|
| xs:ID | ROWID |
| xs:string | If no facets |
| | if UNICODE then NVARCHAR2 (255) |
| | else VARCHAR2 (255) |
| | else if UNICODE |
| | (Size = either length or maxLength) |

| | |
|---------------------|--|
| | If Size <= 2000 then NCHAR |
| | if Size <= 4000 then NVARHCAR2 |
| | if Size <= 4 Gigabytes then NCLOB |
| | else if NON-UNICODE |
| | (Size = either length or maxLength) |
| | If Size <= 2000 then CHAR |
| | if Size <= 4000 then VARCHAR2 |
| | if Size <= 4 Gigabytes then CLOB |
| xs:normalizedString | Same as xs:string |
| xs:token | Same as xs:string |
| xs:Name | Same as xs:string |
| xs:NCName | Same as xs:string |
| xs:anyURI | Same as xs:string |
| xs:QName | Same as xs:string |
| xs:NOTATION | Same as xs:string |
| xs:boolean | NUMBER with constraint Boolean |
| xs:float | FLOAT |
| xs:double | FLOAT |
| xs:decimal | NUMBER |
| xs:duration | TIMESTAMP |
| xs:dateTime | TIMESTAMP |
| xs:time | DATE |
| xs:date | DATE |
| xs:gYearMonth | INTERVAL YEAR TO MONTH |
| xs:gYear | DATE |
| xs:gMonthDay | DATE |
| xs:gDay | DATE |
| xs:gMonth | DATE |
| xs:hexBinary | if no facets then RAW (255) |
| | (Size = either length or maxLength) |
| | If Size <= 2000 then RAW (X) |
| | else Size <= 2 Gigabytes then LONG RAW (X) |

| | |
|-----------------------|---------------------------------------|
| | if Size <= 4 Gigabytes then BLOB (X) |
| xs:base64Binary | BLOB |
| xs:integer | NUMBER |
| xs:int | NUMBER |
| xs:negativeInteger | NUMBER (constrained to {...,-2,-1}) |
| xs:positiveInteger | NUMBER (constrained to {1,2,...}) |
| xs:nonNegativeInteger | NUMBER (constrained to {0,1,2,...}) |
| xs:nonPositiveInteger | NUMBER (constrained to {...,-2,-1,0}) |
| xs:unsignedInt | NUMBER (additional constraints) |
| xs:short | NUMBER |
| xs:unsignedShort | NUMBER (additional constraints) |
| xs:long | NUMBER |
| xs:unsignedLong | NUMBER (additional constraints) |
| xs:byte | BLOB |
| xs:unsignedByte | BLOB (additional constraints) |

27.5 Technical Data

This section contains information on some technical aspects of your software. This information is organized into the following sections:

- [OS and Memory Requirements](#)¹⁶⁶¹
- [Altova Engines](#)¹⁶⁶¹
- [Unicode Support](#)¹⁶⁶²
- [Internet Usage](#)¹⁶⁶²

27.5.1 OS and Memory Requirements

Operating System

Altova software applications are available for the following platforms:

- Windows 10, Windows 11
- Windows Server 2016 or newer

Memory

Since the software is written in C++ it does not require the overhead of a Java Runtime Environment and typically requires less memory than comparable Java-based applications. However, each document is loaded fully into memory so as to parse it completely and to improve viewing and editing speed. As a result, the memory requirement increases with the size of the document.

Memory requirements are also influenced by the unlimited Undo history. When repeatedly cutting and pasting large selections in large documents, available memory can rapidly be depleted.

27.5.2 Altova Engines

XML Validator

When opening an XML document, the application uses its built-in XML validator to check for well-formedness, to validate the document against a schema (if specified), and to build trees and infosets. The XML validator is also used to provide intelligent editing help while you edit documents and to dynamically display any validation error that may occur.

The built-in XML validator implements the Final Recommendation of the W3C's XML Schema 1.0 and 1.1 specifications. New developments recommended by the W3C's XML Schema Working Group are continuously being incorporated in the XML validator, so that Altova products give you a state-of-the-art development environment.

XSLT and XQuery Engines

Altova products use the Altova XSLT 1.0, 2.0, and 3.0 Engines and the Altova XQuery 1.0 and 3.1 Engines. If one of these engines is included in the product, then documentation about implementation-specific behavior for each engine is given in the appendices of the documentation.

Note: Altova MapForce generates code using the XSLT 1.0, 2.0 and XQuery 1.0 engines.

27.5.3 Unicode Support

Altova's XML products provide full Unicode support. To edit an XML document, you will also need a font that supports the Unicode characters being used by that document.

Please note that most fonts only contain a very specific subset of the entire Unicode range and are therefore typically targeted at the corresponding writing system. If some text appears garbled, the reason could be that the font you have selected does not contain the required glyphs. So it is useful to have a font that covers the entire Unicode range, especially when editing XML documents in different languages or writing systems. A typical Unicode font found on Windows PCs is Arial Unicode MS.

In the `/Examples` folder of your application folder you will find an XHTML file called `UnicodeUTF-8.html` that contains the following sentence in a number of different languages and writing systems:

- *When the world wants to talk, it speaks Unicode*
- *Wenn die Welt miteinander spricht, spricht sie Unicode*
- 世界的に話すなら、Unicode です。

Opening this XHTML file will give you a quick impression of Unicode's possibilities and also indicate what writing systems are supported by the fonts available on your PC.

27.5.4 Internet Usage

Altova applications will initiate Internet connections on your behalf in the following situations:

- If you click the "Request evaluation key-code" in the Registration dialog (**Help | Software Activation**), the three fields in the registration dialog box are transferred to our web server by means of a regular http (port 80) connection and the free evaluation key-code is sent back to the customer via regular SMTP e-mail.
- In some Altova products, you can open a file over the Internet (**File | Open | Switch to URL**). In this case, the document is retrieved using one of the following protocol methods and connections: HTTP (normally port 80), FTP (normally port 20/21), HTTPS (normally port 443). You could also run an HTTP server on port 8080. (In the URL dialog, specify the port after the server name and a colon.)
- If you open an XML document that refers to an XML Schema or DTD and the document is specified through a URL, the referenced schema document is also retrieved through a HTTP connection (port 80) or another protocol specified in the URL (see Point 2 above). A schema document will also be retrieved when an XML file is validated. Note that validation might happen automatically upon opening a document if you have instructed the application to do this (in the File tab of the Options dialog (**Tools | Options**)).
- In Altova applications using WSDL and SOAP, web service connections are defined by the WSDL documents.
- If you are using the **Send by Mail** command (**File | Send by Mail**) in XMLSpy, the current selection or file is sent by means of any MAPI-compliant mail program installed on the user's PC.
- As part of Software Activation and LiveUpdate as further described in the Altova Software License Agreement.

27.6 License Information

This section contains information about:

- the distribution of this software product
- software activation and license metering
- the license agreement governing the use of this product

Please read this information carefully. It is binding upon you since you agreed to these terms when you installed this software product.

To view the terms of any Altova license, go to the [Altova Legal Information page](#) at the [Altova website](#).

27.6.1 Electronic Software Distribution

This product is available through electronic software distribution, a distribution method that provides the following unique benefits:

- You can evaluate the software free-of-charge for 30 days before making a purchasing decision. (*Note: Altova MobileTogether Designer is licensed free of charge.*)
- Once you decide to buy the software, you can place your order online at the [Altova website](#) and get a fully licensed product within minutes.
- When you place an online order, you always get the latest version of our software.
- The product package includes an onscreen help system that can be accessed from within the application interface. The latest version of the user manual is available at www.altova.com in (i) HTML format for online browsing, and (ii) PDF format for download (and to print if you prefer to have the documentation on paper).

30-day evaluation period

After downloading this product, you can evaluate it for a period of up to 30 days free of charge. About 20 days into the evaluation period, the software will start to remind you that it has not yet been licensed. The reminder message will be displayed once each time you start the application. If you would like to continue using the program after the 30-day evaluation period, you must purchase a product license, which is delivered in the form of a license file containing a key code. Unlock the product by uploading the license file in the Software Activation dialog of your product.

You can purchase product licenses at <https://shop.altova.com/>.

Helping Others within Your Organization to Evaluate the Software

If you wish to distribute the evaluation version within your company network, or if you plan to use it on a PC that is not connected to the Internet, you may distribute only the installer file, provided that this file is not modified in any way. Any person who accesses the software installer that you have provided must request their own 30-day evaluation license key code and after expiration of their evaluation period, must also purchase a license in order to be able to continue using the product.

27.6.2 Software Activation and License Metering

As part of Altova's Software Activation, the software may use your internal network and Internet connection for the purpose of transmitting license-related data at the time of installation, registration, use, or update to an Altova-operated license server and validating the authenticity of the license-related data in order to protect Altova against unlicensed or illegal use of the software and to improve customer service. Activation is based on the exchange of license related data such as operating system, IP address, date/time, software version, and computer name, along with other information between your computer and an Altova license server.

Your Altova product has a built-in license metering module that further helps you avoid any unintentional violation of the End User License Agreement. Your product is licensed either as a single-user or multi-user installation, and the license-metering module makes sure that no more than the licensed number of users use the application concurrently.

This license-metering technology uses your local area network (LAN) to communicate between instances of the application running on different computers.

Single license

When the application starts up, as part of the license metering process, the software sends a short broadcast datagram to find any other instance of the product running on another computer in the same network segment. If it doesn't get any response, it will open a port for listening to other instances of the application.

Multi-user license

If more than one instance of the application is used within the same LAN, these instances will briefly communicate with each other on startup. These instances exchange key-codes in order to help you to better determine that the number of concurrent licenses purchased is not accidentally violated. This is the same kind of license metering technology that is common in the Unix world and with a number of database development tools. It allows Altova customers to purchase reasonably-priced concurrent-use multi-user licenses.

We have also designed the applications so that they send few and small network packets so as to not put a burden on your network. The TCP/IP ports (2799) used by your Altova product are officially registered with the IANA (see the [IANA Service Name Registry](#) for details) and our license-metering module is tested and proven technology.

If you are using a firewall, you may notice communications on port 2799 between the computers that are running Altova products. You are, of course, free to block such traffic between different groups in your organization, as long as you can ensure by other means, that your license agreement is not violated.

Note about certificates

Your Altova application contacts the Altova licensing server (link.altova.com) via HTTPS. For this communication, Altova uses a registered SSL certificate. If this certificate is replaced (for example, by your IT department or an external agency), then your Altova application will warn you about the connection being insecure. You could use the replacement certificate to start your Altova application, but you would be doing this at your own risk. If you see a *Non-secure connection* warning message, check the origin of the certificate and consult your IT team (who would be able to decide whether the interception and replacement of the Altova certificate should continue or not).

If your organization needs to use its own certificate (for example, to monitor communication to and from client machines), then we recommend that you install Altova's free license management software, [Altova LicenseServer](#), on your network. Under this setup, client machines can continue to use your organization's certificates, while Altova LicenseServer can be allowed to use the Altova certificate for communication with Altova.

27.6.3 Altova End-User License Agreement

- The Altova End-User License Agreement is available here: <https://www.altova.com/legal/eula>
- Altova's Privacy Policy is available here: <https://www.altova.com/privacy>

Index

\$

\$ref (JSON Schemas), 530

▪

.docx, 278, 595

.NET,

- and XMLSpy Debuggers, 771
- differences to XMLSpy standalone, 769
- integration of XMLSpy with, 767

.NET extension functions,

- constructors, 1640
- datatype conversions (.NET to XPath/XQuery), 1643
- datatype conversions (XPath/XQuery to .NET), 1642
- for XSLT and XQuery, 1638
- instance methods, instance fields, 1641
- overview, 1638
- static methods, static fields, 1641

.pptx, 278, 595

.xlsx, 278, 595

A

AAIDC pane, 237

Activating the software, 1084

Active configuration,

- for global resources, 1018

ActiveX,

- integration at application level, 1483
- integration at document level, 1485
- integration prerequisites, 1480

ActiveX controls,

- adding to the Visual Studio Toolbox, 1481
- support, 1120

Add Child command,

- in Grid View, 854

ADO,

- as data connection interface, 609

- setting up a connection, 615

ADO.NET,

- setting up a connection, 621

AI-Assistant,

- OpenAI API key for, 1079

Alias,

- see Global Resources, 696

Altova extensions,

- chart functions (see chart functions), 1553

Altova Global Resources,

- see under Global Resources, 696

Altova products, 124

Altova support, 124

Altova XML Parser,

- about, 1661

Annotations in Schema View, 208

API,

- documentation, 1134
- JAVA, 1436
- JAVA Classpath, 1436
- overview, 1135

Append,

- row (in Authentic View), 929

Append command,

- in Grid View, 854

Application,

- ActiveDocument, 1175
- AddMacroMenuItem, 1176
- AddXSLT_XQParameter, 1176
- Application, 1176
- ClearMacroMenu, 1177
- CurrentProject, 1177
- Dialogs, 1178
- Documents, 1178
- GetDatabaseImportElementList, 1179
- GetDatabaseSettings, 1179
- GetDatabaseTables, 1180
- GetExportSettings, 1181
- GetTextImportElementList, 1181
- GetTextImportExportSettings, 1182
- GetXSLT_XQParameterCount, 1182
- GetXSLT_XQParameterName, 1182
- GetXSLT_XQParameterXPath, 1183
- ImportFromDatabase, 1183
- ImportFromSchema, 1184
- ImportFromText, 1185
- ImportFromWord, 1185
- NewProject, 1187

Application,

- OnBeforeOpenDocument, 1173
- OnBeforeOpenProject, 1174
- OnDocumentOpened, 1174
- OnProjectOpened, 1175
- OpenProject, 1187
- Parent, 1188
- Quit, 1188
- ReloadSettings, 1188
- RemoveXSLT_XQParameter, 1189
- RunMacro, 1189
- ScriptingEnvironment, 1189
- ShowApplication, 1190
- ShowForm, 1190
- URLDelete, 1191
- URLMakeDirectory, 1191
- WarningNumber, 1192
- WarningText, 1192

Apply, 1040**Archive View, 278, 595**

- and EPUB files, 603
- and OOXML files, 597
- and ZIP files, 601

Assertion messages, 263**Assertions in Schema View, 237, 241****Assertions of simple types, 258****Assign,**

- shortcut to a command, 1027

Assigning StyleVision Power Stylesheet to XML file, 922**ATL,**

- plug-in sample files, 1123

Attribute, 67

- in schema definitions, 67
- toggle in Content model view, 67

Attribute groups in Schema View, 238**Attribute preview, 1055****Attribute value templates,**

- XPath intelligent editing in, 363

Attribute values,

- entering in Authentic View, 456

AttributeFormDefault,

- settings in Schema Design View, 884

Attributes, 208**Attributes entry helper,**

- in Authentic View, 465

Attributes in Schema View, 237, 238**Authentic menu, 920**

- dynamic table editing, 460

- markup display, 460

Authentic Scripting,

- security settings, 930
- trusted locations, 930

Authentic View, 478

- adding nodes, 451
- applying elements, 451
- CDATA sections in, 454
- clearing elements, 451
- context menu, 448
- context menus, 469
- data entry devices in, 454
- displaying markup tags, 448
- document display, 463
- editing data in an XML DB, 923
- editing DB data in, 922
- editing XML in, 291
- entering attribute values, 456
- entering data in, 454
- entities in, 454
- entry helpers, 448
- entry helpers in, 465
- formatting text in, 460
- generating output documents from PXF file, 930
- inserting entities in, 457
- inserting nodes, 451
- main window in, 463
- markup display in, 460, 463
- markup in, 928, 929
- opening an XML document in, 447
- opening new XML file in, 921
- overview of GUI, 459
- paste as XML/Text, 469
- printing an XML document from, 458
- removing nodes, 451
- special characters in, 454
- SPS Tables, 477
- switching to, 992
- tables (SPS and XML), 477
- tables in, 451
- toolbar icons, 460
- usage of important features, 472
- usage of XML tables, 478
- XML table icons, 482
- XML tables, 478

Authentic View template, 447**Authentic XML, 444****AuthenticDataTransfer,**

AuthenticDataTransfer,

dropEffect, 1195
 getData, 1195
 ownDrag, 1195
 type, 1196

AuthenticRange,

AppendRow, 1201
 Application, 1202
 CanPerformAction, 1202
 CanPerformActionWith, 1202
 Close, 1203
 CollapsToBegin, 1203
 CollapsToEnd, 1203
 Copy, 1204
 Cut, 1204
 Delete, 1204
 DeleteRow, 1205
 DuplicateRow, 1205
 ExpandTo, 1206
 FirstTextPosition, 1206
 FirstXMLData, 1207
 FirstXMLDataOffset, 1208
 GetElementAttributeNames, 1209
 GetElementAttributeValue, 1210
 GetElementHierarchy, 1210
 GetEntityNames, 1211
 Goto, 1212
 GotoNext, 1212
 GotoNextCursorPosition, 1213
 GotoPrevious, 1214
 GotoPreviousCursorPosition, 1214
 HasElementAttribute, 1215
 InsertEntity, 1215
 InsertRow, 1216
 IsCopyEnabled, 1216
 IsCutEnabled, 1217
 IsDeleteEnabled, 1217
 IsEmpty, 1217
 IsEqual, 1217
 IsFirstRow, 1218
 IsInDynamicTable, 1218
 IsLastRow, 1218
 IsPasteEnabled, 1218
 IsTextStateApplied, 1219
 LastTextPosition, 1219
 LastXMLData, 1220
 LastXMLDataOffset, 1221
 MoveBegin, 1222

MoveEnd, 1222

MoveRowDown, 1223

MoveRowUp, 1223

Parent, 1223

Paste, 1223

PerformAction, 1224

Select, 1225

SelectNext, 1225

SelectPrevious, 1226

SetElementAttributeValue, 1227

SetFromRange, 1228

Text, 1228

AuthenticView, 1247

Application, 1239

AsXMLString, 1239

DocumentBegin, 1241

DocumentEnd, 1241

Event, 1242

Goto, 1243

IsRedoEnabled, 1244

IsUndoEnabled, 1244

MarkupVisibility, 1245

OnBeforeCopy, 1230

OnBeforeCut, 1231

OnBeforeDelete, 1231

OnBeforeDrop, 1232

OnBeforePaste, 1233

OnDragOver, 1233

OnKeyboardEvent, 1235

OnMouseEvent, 1236

OnSelectionChanged, 1236

Parent, 1245

Print, 1245

Redo, 1246

Selection, 1246

Undo, 1247

WholeDocument, 1248

XMLDataRoot, 1248

Auto-complete,

text view enable/disable, 1047

Auto-completion in SQL scripts, 941**Auto-hiding windows, 107****Automatic Backup, 128****Automatic backup settings, 1041****Automatic validation, 1043****Avro Schema, 507****Azure SQL, 662**

B

Back,

in Schema View, 273

Background Information, 1661

Backups, 128

Base type,

modifying, 266

Base64-encoded images, 187

Big-endian, 1046

Bookmark margin, 995

Bookmarks,

inserting and removing, 821

navigating, 821

Bookmarks in SQL scripts, 941

Bookmarks in Text View, 133

Breakpoint,

dialog box, 918

Breakpoints,

using in XSLT/XQuery Debugger, 404

Breakpoints dialog, 402

Breakpoints in XPath/XQuery Debugger, 428

Browse,

Oracle XML Db, 959

Browser, 1055

View, 993

Browser pane,

in Database Query window, 937

Browser View,

font size, 998

moving back and forward, 998

refresh content of, 998

separate windows, 998

stop loading page, 998

BSON in MongoDB, 550

BSON schema editing, 550

Builder Mode, 436

Built-in templates,

in XSLT/XQuery Debugger, 414

integration of XMLSpy, 1488

Call stack (XPath/XQuery), 428

Call Stack Window,

in XSLT/XQuery Debugger, 414

Calling named templates, 368

Carriage return key,

see Enter key, 496

Catalog,

Oasis XML, 857

Catalog customization, 333

Catalog mechanism overview, 331

Catalogs, 331

Catalogs and environment variables, 335

Catalogs and intelligent editing, 333

Catalogs in XMLSpy, 332

CDATA sections,

inserting in Authentic View, 472

Changing view,

to Authentic View, 460

Character,

position, 995

Character-Set,

encoding, 1046

Check,

spelling checker, 1000

Class,

JAVA, 1436

ClassPath statement, 1436

Code page, 1063

CodeGeneratorDlg,

Application, 1249

CPPSettings_DOMType, 1250

CPPSettings_LibraryType, 1251

CPPSettings_UseMFC, 1251

CSharpSettings_ProjectType, 1252

OutputPath, 1252

OutputPathDialogAction, 1252

OutputResultDialogAction, 1253

Parent, 1253

ProgrammingLanguage, 1253

PropertySheetDialogAction, 1254

TemplateFileName, 1254

Collapse,

unselected, 994

Collapse markup (in Authentic View), 929

Color, 1063

COM API,

in Scripting Editor, 1101

C

C#,

- COM-API,**
 - documentation, 1134
- Command, 1031**
 - add to toolbar/menu, 1023
 - context menu, 1031
 - delete from menu, 1031
 - reset menu, 1031
- Command line actions, 1089**
- Command reference, 1501**
- Commands,**
 - listing in key map, 1083
- Commenting in and out,**
 - in XML documents in Text View., 287
- Commenting XML text in and out, 822**
- Comments, 205**
- Comments in Schema View, 208**
- Comments in SQL scripts, 941**
- Comparing directories, 1012**
- Comparing files, 1008**
 - options, 1015
- Comparisons,**
 - of directories, 740
 - of files, 739
 - of files and directories, 738
- Complex type, 57**
 - extending definition, 57
 - in schema definitions, 57
- Complex types,**
 - anonymous, 208
 - global, 208
 - named, 208
- Component definition,**
 - reusing, 57
- Components entry helper, 252, 258**
- Compositor,**
 - for sequences, 45
- Compositors in Schema View, 218**
- Conditional type alternatives, 230**
- Conditional type assignments, 230**
- Configurations,**
 - of a global resource, 697
- Configurations in global resources, 712**
- Configure,**
 - XMLSPY UI, 1120
- Configure view,**
 - dialog for Content Model View, 893
- Connecting to SchemaAgent Server, 338, 901**
- Content Model,**
 - creating a basic model, 45
 - save diagram, 887
 - toggle attributes, 67
- Content Model View, 42**
 - assigning conditional types, 230
 - compositors and components, 218
 - configuring, 893
 - diagram objects, 218
 - editing in, 224
 - general description, 216
 - interface description, 218
- Content models,**
 - of schema components, 216
- Context menu,**
 - commands, 1031
 - for customization, 1036
- Context menus,**
 - in Authentic View, 469
- Context Window,**
 - in XSLT/XQuery Debugger, 412
- Convert,**
 - database data to XML, 964
 - database schema to XML Schema, 969
 - MS Word data to XML, 969
 - Oracle XML Db, 956
 - schema to DB structure, 975
 - text file to XML, 961
- Convert menu, 961**
- Copy command, 804**
- Copy Grid View text, 805**
- Copy Grid View text as tab-structured text, 806**
- Copy image in Grid View, 806**
- Copy XPath, 807**
- Copy XPointer, 807**
- Copyright information, 1663**
- CoreCatalog.xml, 332**
- CR&LF, 1041**
- Create,**
 - DB based on schema, 975
- CSS, 499**
 - auto-completion, 502
 - document outline, 502
 - Info window, 502
 - properties, 502
 - syntax coloring, 502
- CSS Info window, 502**
- CSV file,**
 - import as XML, 961

Custom dictionary, 1000**CustomCatalog, 857****CustomCatalog.xml, 332****Customization, 121****Customize, 1031**

- context menu, 1031
- Customize context menu, 1036
- macros, 1033
- menu, 1031
- toolbar/menu commands, 1023

Cut command, 804

D

Database,

- create DB based on schema, 975
- editing records of, 945
- export of XML data to, 981
- import data as XML, 964
- import structure as XML Schema, 969
- Oracle XML Db, 956

Database connection,

- reusing from Global Resources, 639
- setting up, 609
- setup examples, 640
- starting the wizard, 610

Database drivers,

- overview, 612

Database Query,

- Browser pane in DB Query window, 937
- Connecting to DB for query, 934
- creating the query, 944
- Editing results, 945
- Messages pane, 945
- Results of, 945

Database Query window, 932**Database/Table View,**

- how to use, 93

DatabaseConnection,

- ADOConnection, 1255
- AsAttributes, 1256
- CreateMissingTables, 1256
- CreateNew, 1256
- DatabaseKind, 1257
- ExcludeKeys, 1257
- File, 1257

- IncludeEmptyElements, 1258
- NumberDateTimeFormat, 1259
- ODBCConnection, 1259
- SQLSelect, 1260
- TextFieldLen, 1260

Databases,

- and global resources, 711
- editing in Authentic View, 922
- see also DB, 484
- support in XMLSpy, 695

Databases in XMLSpy, 607**Date Picker,**

- using in Authentic View, 491

Dates,

- changing manually, 492

DB, 484, 485

- creating queries, 485
- editing in Authentic View, 484, 489
- filtering display in Authentic View, 485
- navigating tables in Authentic View, 485
- parameters in DB queries, 485
- queries in Authentic View, 484

DB XML,

- assigning XML Schemas to, for IBM DB2, 952
- managing XML Schemas, for IBM DB2, 949

db2-fn:sqlquery, 394**db2-fn:xmlcolumn, 394****Debug points in XPath/XQuery Debugger, 428****Debugger,**

- breakpoints/tracepoints dialog box, 918
- debug windows, 919
- enable/disable breakpoint, 917
- enable/disable tracepoint, 917
- end session, 915
- insert/remove breakpoint, 917
- insert/remove tracepoint, 917
- restart XSLT Debugger, 915
- settings, 919
- show curr. exec. nodes, 916
- start XSLT Debugger, 915
- step into, 916
- step out, 916
- step over, 916
- stop XSLT Debugger, 915

Debugging XPath/XQuery expressions, 428**Default,**

- encoding, 1046
- menu, 1031

Default editor, 1043**Default open content models, 234****Default view,**

setting in Main Window, 1043

defaultOpenContent, 208**Definitions Overview Grid, 523****Delete, 1023**

Application.URLDelete, 1191

command from context menu, 1031

command from toolbar, 1023

icon from toolbar, 1023

row (in Authentic View), 929

shortcut, 1027

toolbar, 1024

Delete command, 804**Delete row in Authentic View, 929****Derived types,**

modifying base type of, 266

Deriving a schema type, 267**Details entry helper, 45, 256****Dialogs,**

Application, 1261

CodeGeneratorDlg, 1261

DTDSchemaGeneratorDlg, 1263

FileSelectionDlg, 1262

GenerateSampleXMLDlg, 1263

Parent, 1262

SchemaDocumentationDlg, 1263

Dictionary, 1000

adding custom, 1000

modifying existing, 1000

spelling checker, 1000

directories,

comparing two, 1012

creating with Application.URLMakeDirectory, 1191

Directory comparisons, 738, 740**Disable,**

breakpoint - XSLT debugger, 917

tracepoint - XSLT debugger, 917

Disconnect XMLSpy from SchemaAgent, 902**Display all globals, 896****Display diagram, 896****Distribution,**

of Altova's software products, 1663

DocEditEvent (obsolete),

altKey (obsolete), 1386

altLeft (obsolete), 1387

button (obsolete), 1388

cancelBubble (obsolete), 1389

clientX (obsolete), 1389

clientY (obsolete), 1390

ctrlKey (obsolete), 1391

ctrlLeft (obsolete), 1392

dataTransfer (obsolete), 1392

fromElement (obsolete), 1393

keyCode (obsolete), 1393

propertyName (obsolete), 1394

repeat (obsolete), 1394

returnValue (obsolete), 1395

shiftKey (obsolete), 1395

shiftLeft (obsolete), 1396

srcElement (obsolete), 1396

type (obsolete), 1397

DocEditView (obsolete),

ApplyTextState (obsolete), 1401

CurrentSelection (obsolete), 1402

EditClear (obsolete), 1402

EditCopy (obsolete), 1403

EditCut (obsolete), 1403

EditPaste (obsolete), 1404

EditRedo (obsolete), 1404

EditSelectAll (obsolete), 1405

EditUndo (obsolete), 1405

event (obsolete), 1405

GetAllowedElements (obsolete), 1406

GetNextVisible (obsolete), 1408

GetPreviousVisible (obsolete), 1408

IsEditClearEnabled (obsolete), 1409

IsEditCopyEnabled (obsolete), 1410

IsEditCutEnabled (obsolete), 1410

IsEditPasteEnabled (obsolete), 1411

IsEditRedoEnabled (obsolete), 1411

IsEditUndoEnabled (obsolete), 1412

IsRowAppendEnabled (obsolete), 1412

IsRowDeleteEnabled (obsolete), 1413

IsRowDuplicateEnabled (obsolete), 1413

IsRowInsertEnabled (obsolete), 1414

IsRowMoveDownEnabled (obsolete), 1414

IsRowMoveUpEnabled (obsolete), 1414

IsTextStateApplied (obsolete), 1415

IsTextStateEnabled (obsolete), 1415

LoadXML (obsolete), 1416

RowAppend (obsolete), 1417

RowDelete (obsolete), 1417

RowDuplicate (obsolete), 1418

RowInsert (obsolete), 1418

DocEditView (obsolete),

RowMoveDown (obsolete), 1419
RowMoveUp (obsolete), 1419
SaveXML (obsolete), 1420
SelectionMoveTabOrder (obsolete), 1421
SelectionSet (obsolete), 1421
XMLRoot (obsolete), 1422

Docking windows, 107**Document, 1276**

Application, 1269
AssignDTD, 1269
AssignSchema, 1269
AssignXSL, 1269
AssignXSLFO, 1270
AuthenticView, 1270
browse Oracle XML Db, 959
Close, 1271
ConvertDTDOOrSchema, 1271
CreateChild, 1273
CreateSchemaDiagram, 1274
CurrentViewMode, 1275
DataRoot, 1275
DocEditView, 1275
Encoding, 1275
EndChanges, 1276
ExecuteXQuery, 1276
ExportToDatabase, 1277
ExportToText, 1278
FullName, 1279
GenerateDTDOOrSchema, 1280
GenerateProgramCode, 1281
GenerateSampleXML, 1281
GenerateSchemaDocumentation, 1282
GetExportElementList, 1283
GetPathName, 1283
GridView, 1284
IsModified, 1284
IsValid, 1284
IsWellFormed, 1286
Name, 1287
OnBeforeCloseDocument, 1267
OnBeforeSaveDocument, 1266
OnBeforeValidate, 1267
OnCloseDocument, 1268
OnViewActivation, 1268
Path, 1287
RootElement, 1288
Save, 1288

SaveAs, 1288
Saved, 1289
SaveInString, 1289
SaveToURL, 1289
SetActiveDocument, 1290
SetEncoding, 1290
SetExternalsValid, 1291
SetPathName, 1291
Spelling checker, 1000
StartChanges, 1291
SwitchViewMode, 1292
Title, 1293
TransformXSL, 1293
TransformXSLFO, 1293
UpdateViews, 1294
UpdateXMLData, 1294
XQuery, 1276

Documentation,

for schema, 72
of XML Schema files, 887

Document-level,

examples of integration of XMLSpy, 1488

Documents,

Count, 1296
Item, 1296
NewAuthenticFile, 1296
NewFile, 1297
NewFileFromText, 1297
OpenAuthenticFile, 1297
OpenFile, 1298
OpenURL, 1298
OpenURLDialog, 1299

Documents in Main Window, 108**Drag-and-drop in JSON Grid View, 174****Drag-and-drop in XML Grid View, 172****DTD,**

assigning to XML document, 868
converting to UML, 878
converting to XML Schema, 874
generate outline XML file from, 879
generating from XML document, 872
generating from XML Schema (Enterprise and Professional editions), 326
go to definition in from XML document, 871
go to from XML document, 871
including entities, 870
menu commands related to, 868

DTD/Schema menu, 868

DTDs, 306, 1041, 1043

- converting to XML Schemas (Enterprise and Professional editions), 323
- editing in Grid View (Enterprise and Professional editions), 323
- editing in Text View, 323
- generating XML document from, 323

DTDs and catalogs, 331**DTDSchemaGeneratorDlg,**

- Application, 1300
- AttributeTypeDefinition, 1300
- DTDSchemaFormat, 1300
- FrequentElements, 1301
- GlobalAttributes, 1301
- MaxEnumLength, 1301
- MergeAllEqualNamed, 1301
- OnlyStringEnums, 1302
- OutputPath, 1302
- OutputPathDialogAction, 1302
- Parent, 1303
- ResolveEntities, 1303
- TypeDetection, 1303
- ValueList, 1303

Duplicate,

- row (in Authentic View), 929

Dynamic (SPS) tables in Authentic View,

- usage of, 477

Dynamic tables,

- editing, 460

E**Eclipse platform,**

- and XMLSpy, 772
- and XMLSpy Integration Package, 773
- XMLSpy Debugger perspectives, 780
- XMLSpy entry points in, 778
- XMLSpy Perspective in, 775

Edit,

- macro button, 1036

Edit as Raw Text,

- in Grid View, 854

Edit menu, 803**Edited with XMLSPY, 1041****Editing database records, 945****Editing in Text View, 136****Editing views, 126****Element, 53**

- making optional, 53
- restricting content, 53

element type,

- specifying in XML document, 79

ElementFormDefault,

- settings in Schema Design View, 884

ElementList,

- Count, 1304
- Item, 1304
- RemoveElement, 1304

ElementListItem,

- ElementKind, 1305
- FieldCount, 1305
- Name, 1305
- RecordCount, 1305

Elements entry helper,

- in Authentic View, 465

E-mail,

- sending files with, 798

Empty elements, 1043**Empty lines,**

- in XML documents in Text View, 287

Enable breakpoint - XSLT debugger, 917**Enable tracepoint - XSLT debugger, 917****Encoding,**

- default, 1046
- of files, 792

End,

- debugger session, 915

End User License Agreement, 1663, 1665**End-of-line markers, 995****Enhanced Grid View, 992**

- see Grid View, 81

Enter key,

- effects of using, 496

Entities,

- defining in Authentic View, 472, 492
- in XML Schema-based XML, 285
- inserting in Authentic View, 457, 472

Entities entry helper,

- in Authentic View, 465

Entry Helper,

- Details, 45
- in Grid View, 91

Entry Helpers, 112

- display of, 1080

Entry Helpers, 112

- for XQuery, 378
- updating, 863

Entry helpers (Text View, Authentic View), 293**Entry Helpers in Grid View, 162****Entry helpers in Schema View, 252****Entry helpers in Text View, 142****Enumeration,**

- defining for attributes, 67

Enumerations,

- in XMLSpyControl, 1541
- SPYAttributeTypeDefinition, 1423
- SPYAuthenticActions, 1423
- SPYAuthenticDocumentPosition, 1423
- SpyAuthenticElementActions, 1423
- SPYAuthenticElementKind, 1424
- SPYAuthenticMarkupVisibility, 1424
- SPYDatabaseKind, 1425
- SPYDialogAction, 1425
- SPYDOMType, 1425
- SPYDTDSchemaFormat, 1426
- SPYEncodingByteOrder, 1426
- SPYExportNamespace, 1426
- SPYFrequentElements, 1426
- SPYKeyEvent, 1427
- SPYLibType, 1428
- SPYLoading, 1428
- SPYMouseEvent, 1428
- SPYNumberDateTimeFormat, 1429
- SPYProgrammingLanguage, 1429
- SPYProjectItemTypes, 1429
- SPYProjectType, 1430
- SPYSampleXMLGenerationOptimization, 1430
- SPYSampleXMLGenerationSchemaOrDTDAssignment, 1431
- SPYSchemaDefKind, 1431
- SPYSchemaDocumentationFormat, 1432
- SPYTextDelimiters, 1432
- SPYTextEnclosing, 1433
- SPYTypeDetection, 1433
- SPYURLTapes, 1433
- SPYViewModes, 1434
- SPYVirtualKeyMask, 1435
- SPYXMLDataKind, 1435

Enumerations of simple types, 258**Environment variables used in catalogs, 332****Environment variables, 335****EPUB files, 603****Evaluating XPath, 115****Evaluation key,**

- for your Altova software, 1084

Evaluation period,

- of Altova's software products, 1663

Event, 1173, 1174, 1175, 1230, 1231, 1232, 1233, 1235, 1236, 1266, 1267, 1268, 1328, 1329, 1330**Events, 1141****Excel 2007, 278, 595****Exit mode, 1041****Expand,**

- fully, 994

Expand markup (in Authentic View), 929**Explorer, 1043****Exporting XML data to database, 981****Exporting XML data to text files, 978****ExportSettings,**

- CreateKeys, 1306
- ElementList, 1306
- EntitiesToText, 1307
- ExportAllElements, 1307
- FromAttributes, 1307
- FromSingleSubElements, 1307
- FromTextValues, 1307
- IndependentPrimaryKey, 1308
- Namespace, 1308
- SubLevelLimit, 1308

Expression Builder, 436**Extended validation, 345**

- in SchemaAgent, 902

Extension functions for XSLT and XQuery, 1629**Extension Functions in .NET for XSLT and XQuery,**

- see under .NET extension functions, 1638

Extension Functions in Java for XSLT and XQuery,

- see under Java extension functions, 1629

Extension Functions in MSXSL scripts, 1644**External applications,**

- opening files in, 1026

External JSON content,

- copy to JSON Grid View, 174
- drag-and-drop to JSON Grid View, 174

External parsed entites, 1043**External XML content,**

- copy to XML Grid View, 172
- drag-and-drop to XML Grid View, 172

External XSL processor, 1068

F

Facets of simple types, 258

File, 1041

- closing, 793
- creating new, 782
- default encoding, 1046
- encoding, 792
- opening, 787
- opening options, 1041
- printing options, 799
- saving, 793
- sending by e-mail, 798
- tab, 1041

File comparisons, 738, 739

File DSN,

- setting up, 628

File extensions,

- customizing, 857
- for XQuery files, 377

File menu, 782

File paths,

- inserting in XML document, 287

File types, 1043

Files,

- adding to source control, 833
- comparing two, 1008
- comparison options, 1015
- most recently used, 801

FileSelectionDlg,

- Application, 1309
- DialogAction, 1309
- FullName, 1309
- Parent, 1310

Filters in Grid View, 184

- settings of, 192

Find,

- and replace text in document, 818
- text in document, 812
- using regular expressions, 812

Find in Files command, 819

Find in Files Window, 117

Find in Schemas, 348

- executing Find and Replace commands, 357
- global components, 360

- renaming global components, 360
- replace term, 350
- restricting search by property and property value, 353
- restricting search to components, 351
- results, 359
- search term, 350
- setting scope of, 356
- window, 359

Find in Schemas Window, 119

Firebird,

- Connecting through JDBC, 641
- Connecting through ODBC, 642

Floating windows, 107

Folding margin, 995

Font, 1065

- schema, 1065
- Schema Documentation, 1065

Fonts in Text View, 131

FOP,

- fonts, 302

Foreign keys,

- disable in SQLite, 638

Formatting in Text View, 131

Formulas in Grid View,

- settings of, 192

Formulas in XML Grid View, 177, 180

Forward,

- in Schema View, 273

G

Generate,

- DB structure based on schema, 975

Generate Sample XML, 1423, 1430, 1431

GenerateSampleXMLDlg,

- Application, 1323
- FillWithSampleData, 1324
- NonMandatoryAttributes, 1325
- NonMandatoryElements, 1325
- Parent, 1326
- RepeatCount, 1327
- TakeFirstChoice, 1327

Global,

- settings, 1040

Global attribute groups, 208

Global attributes, 208

Global comments,

line display of, 205

Global element,

using in XML Schema, 65

Global elements, 208**Global resources, 696**

active configuration for, 1018

changing configurations, 712

defining, 697, 1017

defining database-type, 706

defining file-type, 699

defining folder-type, 704

toolbar activation, 1024

using, 708, 711, 712

using file-type and folder-type, 708

Global Resources XML File, 697**Global schema components,**

finding and renaming, 360

Go to File, 995**Go to line/char, 995****Grammar, 1043****Graphics formats,**

in Authentic View, 495

Gray bar, 993**Grid fonts, 1063****Grid view, 91, 146, 992, 993**

adding, deleting nodes, 155

and Table View, 93

appending elements and attributes, 91

auto-completion, 156

context menu of, 189

data-entry in, 81

document display, 147

editing document content in, 156

editing document structure, 155

editing node types, 156

entry helpers, 155

features of, 147

filters in, 184

find and replace, 156

header bars in, 147

images in, 187

scroll headers in, 147

Split View in, 160

using Entry Helpers, 91

validation, 156

Grid View (JSON),

drag-and-drop in, 174

formulas in, 180

see JSON Grid View, 520

Table Display in, 167

Grid View (XML), 290

drag-and-drop in, 172

formulas in, 177

Table Display in, 163

Grid View entry helpers, 162**Grid View of JSON documents,**

see JSON Grid View, 520

Grid View settings, 192**Grid View tables,**

copying as TSV or XML, 192

GridView,

CurrentFocus, 1331

Deselect, 1331

IsVisible, 1331

OnBeforeDrag, 1328

OnBeforeDrop, 1329

OnBeforeStartEditing, 1329

OnEditingFinished, 1330

OnFocusChanged, 1330

Select, 1331

SetFocus, 1331

GUI description, 107

H

Header bars in Grid View, 147**Help,**

key map, 1083

Help menu, 1083**Hide markup, 460, 463****Hide markup (in Authentic View), 928****Hotkey, 1027****HTML, 499****HTML documents,**

editing, 500

Info window, 500

HTML Info window, 500**HTML output,**

generating in Authentic View from PXF file, 930

HTTP, 583**HTTP message window,**

and Accept header, 591

and HTTP status codes, 591

HTTP message window,

- and WADL, 589
- HTTP methods, 584
- importing a request into, 589
- logs, 591
- receiving a response, 591
- sending the request, 584

IBM DB2,

- assigning XML Schemas to XML file, 952
- connecting through JDBC, 645
- connecting through ODBC, 647
- managing XML Schemas, 949
- schema management and assignment, 948

IBM DB2 for i,

- connecting through JDBC, 653
- connecting through ODBC, 654

IBM Informix,

- connecting through JDBC, 656

Icon,

- add to toolbar/menu, 1023
- show large, 1036

Identity constraint,

- toggle in Content model view, 67

Identity constraints in Schema View, 237, 245**Image formats,**

- in Authentic View, 495

Images in Grid View, 187**Import,**

- database data as XML, 964
- database data based on XML Schema, 974
- database structure as XML Schema, 969
- MS Word document as XML, 969
- text file as XML, 961

Indentation,

- in Text View, 812

Indentation guides, 995**Indentation in Text View, 131****Info Window, 112**

- display of, 1080
- for CSS documents, 502
- for HTML documents, 500
- in XSLT/XQuery Debugger, 415

Info window, XSLT tab,

- and creating Zip folders, 371
- and Projects, 371
- and XSLT documents, 371
- description of, 371
- see also XSL Outline, 371

Insert,

- breakpoint - XSLT debugger, 917
- row (in Authentic View), 929
- tracepoint - XSLT debugger, 917

Insert After/Before command,

- in Grid View, 854

Integrating,

- XMLSpy in applications, 1480

Integration Package for Eclipse,

- installing, 773

Intelligent Editing, 1047**Internet, 1088****Internet usage,**

- in Altova products, 1662

J**Java, 1491**

- API, 1436
- ClassPath, 1436

Java extension functions,

- constructors, 1634
- datatype conversions, Java to XPath/XQuery, 1637
- datatype conversions, XPath/XQuery to Java, 1636
- for XSLT and XQuery, 1629
- instance methods, instance fields, 1636
- overview, 1629
- static methods, static fields, 1635
- user-defined class files, 1631
- user-defined JAR files, 1633

Java settings, 1072**Java virtual machine,**

- path setting, 1072

JDBC,

- as data connection interface, 609
- connect to Teradata, 688
- setting up a connection (Windows), 631

JRE,

- for XMLSpy Integration Package for Eclipse, 773

JScript,

- scripting with XMLSpy, 1092

JSON,

- and XPath, 565
- and XPath/XQuery Output Window, 565
- and XQuery, 565
- convert JSON instance to/from XML instance, 984
- convert JSON schema to/from XML schema, 987
- convert to/from YAML, 990
- XQuery expressions for, 567

JSON data,

- arrays, 509
- example, 509
- objects, 509
- types, 509

JSON document,

- generating from JSON schema, 572

JSON documents,

- converting to and from XML, 515, 573
- converting to and from YAML, 582
- creating new, 507
- editing in Grid View, 520
- editing in Text View, 515
- opening in XMLSpy, 507
- validating, 561
- XQuery expressions for, 439

JSON Grid View, 520

- add components as child, 865
- append components, 865
- flip rows and columns of table, 866
- insert components, 865
- re-evaluate all filters and formulas, 867
- see Grid View, 146
- sort column in table, 866
- Table Display command, 866
- Type command, 865
- wrap component in array, 865
- wrap component in object, 865

JSON Lines, 514**JSON menu, 864****JSON Schema, 507, 514**

- adding global definitions, 526
- allOf, 554
- any, 548
- anyOf, 554
- arrays, 544
- atomic types, 546
- conditionals, 556
- description, 512
- forbidden, 548

- generating from JSON instance, 569
- generating from YAML document, 578
- if-then-else, 556
- multiple, 548
- not, 554
- numeric definitions, 546
- object properties, 533
- objects, 533, 537
- objects and dependencies, 540
- oneOf, 554
- operators, 554
- primitive types, 546
- simple types, 546
- string definitions, 546
- terminology, 512
- type selectors (any, multiple), 548
- type selectors (unconstrained, forbidden), 548
- unconstrained, 548
- unspecified properties, 537

JSON Schema version, 524**JSON Schema View, 523**

- \$ref, 530
- adding external schemas, 527
- configuring, 557
- Constraints entry helper, 527
- Design View, 532
- Details entry helper, 527
- entry helpers, 527
- extended references to JSON Schemas, 530
- global and local definitions, 530

JSON text from external sources,

- adding quickly to document, 563

JSON transformations with XSLT/XQuery, 565**JSONSchemaDocumentationDlg,**

- AllDetails, 1333
- Application, 1333
- IncludeAll, 1335
- IncludeAttributeGroups, 1335
- IncludeComplexTypes, 1335
- IncludeGlobalElements, 1336
- IncludeGroups, 1336
- IncludeIndex, 1336
- IncludeLocalElements, 1337
- IncludeRedefines, 1337
- OptionsDialogAction, 1338
- OutputFile, 1338
- OutputFileDialogAction, 1339
- OutputFormat, 1339

JSONSchemaDocumentationDlg,

- Parent, 1339
- ShowAnnotations, 1339, 1342, 1343, 1344
- ShowConstraints, 1340
- ShowDiagram, 1340
- ShowEnumerations, 1340
- ShowNamespace, 1341
- ShowProgressBar, 1341
- ShowProperties, 1341
- ShowResult, 1342
- ShowSingleFacets, 1342
- ShowSourceCode, 1343
- ShowType, 1343
- ShowUsedBy, 1344

K**Key map, 1083****Keyboard shortcut, 1027****Key-codes,**

- for your Altova software, 1084

L**Large markup (in Authentic View), 928****Legal information, 1663****License, 1665**

- information about, 1663

License metering,

- in Altova products, 1664

Licenses,

- for your Altova software, 1084

Line,

- go to, 995

Line length,

- word wrap in text view, 994

Line margin, 995**Line numbering in Text View, 133****Line-breaks, 1041****Links,**

- following in Authentic View, 472

Little-endian, 1046**loading, 1298****M****Macro,**

- add to menu/toolbar, 1033
- edit button, 1036

Macros,

- developing, 1092, 1097
- enabling, 1104, 1116
- running, 1117
- running application macros, 1007

Main Window, 108**MainCatalog, 857****MapForce, 879****MariaDB,**

- connect through ODBC, 658
- connecting natively, 638

Markup,

- in Authentic View, 460, 463

Markup (in Authentic View),

- collapse/expand, 929
- hide, 928
- show small/large/mixed, 928

Maximum cell width, 1055**Memory,**

- storage of schema information, 883

Memory requirements, 1661**Menu, 1031**

- add macro to, 1033
- add/delete command, 1023
- Authentic, 920
- Convert, 961
- customize, 1031
- Default/XMLSPY, 1031
- delete commands from, 1031
- DTD/Schema, 868
- Edit, 803
- Help, 1083
- JSON, 864
- Project, 823
- Schema Design, 884
- Tools, 999
- View, 991
- XML, 853
- XSL/XQuery, 906

Menu Bar, 119

Messages Window, 113

- display of, 1080
- in XSLT/XQuery Debugger, 416

Metadata file for formulas, 177, 180**Microsoft Access,**

- connecting through ADO, 615, 660

Microsoft Azure SQL, 662**Microsoft Office 2007, 278, 595****Microsoft SQL Server,**

- connecting through ADO, 663
- connecting through ODBC, 665

Microsoft® SharePoint® Server, 844**MIME, 1043****Mixed markup (in Authentic View), 928****Model groups, 208****Modes of templates,**

- in XSLT/XQuery Debugger, 414

MongoDB and BSON, 550**Mostly recently used files,**

- list of, 801

Move commands,

- in Grid View, 855

Move row in Authentic View, 929**MS SQL Server,**

- schema extensions, 899
- schema settings, 900

MSXML, 1068**msxsl:script, 1644****Multi-user, 1041****MySQL,**

- connecting natively, 638
- connecting through ODBC, 671

N

Named schema relationships,

- MS SQL Server schema settings, 900

Named templates, 368**Namespaces,**

- in schemas, 44

Namespace Prefix,

- inserting in Grid View, 863

Namespaces,

- settings in Schema Design View, 884

Native connections, 638**Navigation,**

- shortcuts in schema design, 70

Navigation history, 273**Network proxy, 1077****Network settings, 1076****New features, 23****New file,**

- creating, 782

New XML document,

- creating, 77

Node,

- show curr. exec. node, 916

Non-XML files, 1043**Notations in Schema View, 208**

O

OASIS,

- XML catalog, 857

Object Locator,

- in Database Query window, 937

Occurrences,

- number of, 45

ODBC,

- as data connection interface, 609
- connect to MariaDB, 658
- connect to Teradata, 690
- setting up a connection, 628

ODBC Drivers,

- checking availability of, 628

Office Open XML, 278, 595**OLE DB,**

- as data connection interface, 609

Online Help, 1079, 1083**OOXML,**

- see under Office Open XML, 278, 595

Open,

- file, 787

Open content models, 234**Open Office XML,**

- creating in Archive View, 597
- editing in Archive View, 597
- example files, 599

OpenAI API key, 1079**openContent, 208****Opening options,**

- file, 1041

OpenJDK,

- as Java Virtual Machine, 631

Optimal Widths, 994, 1055**Optional element,**

- making, 53

Oracle,

- schema extensions, 897
- schema settings, 898

Oracle database,

- connecting through JDBC, 673
- connecting through ODBC, 675

Oracle XML Db, 956

- Browse database, 959
- manage XML Schemas, 956

Ordering Altova software, 1084**OS,**

- for Altova products, 1661

Output formatting, 1041**Output Windows,**

- display of, 1080

Overrides, 208**Overview,**

- of XMLSpy API, 1135

P

Parameters,

- in DB queries, 485
- passing to stylesheet via interface, 910

Parent, 1287**Parser,**

- built into Altova products, 1661
- XSLT, 1068

Paste,

- as Text, 472
- as XML, 472

Paste As,

- Text, 469
- XML, 469

Paste command, 804**Patterns of simple types, 258****PDF,**

- transforming to in XMLSpy, 365

PDF fonts, 302**PDF Help, 1079, 1083****PDF output,**

- generating in Authentic View from PXF file, 930

Pending Update List (PUL), 387**Platforms,**

- for Altova products, 1661

Plug-in,

- ATL sample files, 1123
- registration, 1119
- User interface configuration, 1120
- XMLSPY, 1119

Position, 995

- Character, 995
- Line, 995

PostgreSQL,

- connecting natively, 638
- connecting through ODBC, 679

PowerPoint 2007, 278, 595**Presentation, 1055****Pretty-print,**

- in Text View, 812

Print setup, 800**Printing,**

- from Authentic View, 458

Printing options, 799**Priority of templates,**

- in XSLT/XQuery Debugger, 414

Processing Instructions in Schema View, 208**Program settings, 1040****Programmers' Reference, 1090****Progress OpenEdge database,**

- connecting through JDBC, 682
- connecting through ODBC, 683

Project,

- properties, 849

Project management in XMLSpy, 102**Project menu, 823****Project Window, 110**

- display of, 1080

Projects, 841

- adding active files to, 841
- adding external folders to, 842
- adding external Web folders to, 844
- adding files to, 840
- adding folders to, 842
- adding global resources to, 841
- adding related files to, 841
- adding to source control, 833
- adding URL to, 841
- batch processing with, 719

Projects, 841

- benefits of using, 719
- closing, 826
- creating new, 825
- how to create and edit, 715
- most recently used, 852
- naming, 715
- opening, 826
- overview, 823
- overview of, 714
- properties of, 715
- reloading, 826
- saving, 715, 826
- using, 719

Projects in XMLSpy,

- benefits of, 102
- how to create, 102

Proxy settings, 1077**PUBLIC,**

- identifier - catalog, 857

PUL in XQuery Update, 387**PXF file,**

- generating output documents from Authentic View, 930

Q

Queries,

- for DB display in Authentic View, 485

Query,

- see under Database Query window, 932
- see under Query Database, 932
- see under XQuery, 932

Query Database command, 932**Query pane,**

- in Database Query window, 941

R

Redefines, 208**Redo command, 804****Referencing JSON Schemas, 530****Regions in SQL scripts, 941****Register,**

- plug-in, 1119

Registering your Altova software, 1084**Registry,**

- settings, 1040

Regular expressions, 819

- find and replace using, 812
- in search string, 812

Reload, 1041**Reloading,**

- changed files, 792

Remove,

- breakpoint - XSLT debugger, 917
- tracepoint - XSLT debugger, 917

Repeated elements, 1047**Replace, 117**

- text, 812
- text in document, 818
- text in multiple files, 819
- using regular expressions, 812

Reset,

- menu commands, 1031
- shortcut, 1027
- toolbar & menu commands, 1024

Restart,

- XSLT debugger, 915

Return key,

- see Enter key, 496

RichEdit, 928**RootCatalog.xml, 332****Row,**

- append (in Authentic View), 929
- delete, 929
- delete (in Authentic View), 929
- duplicate (in Authentic View), 929
- insert (in Authentic View), 929
- move up/down, 929

RTF output,

- generating in Authentic View from PXF file, 930

S

Sample values of simple types, 258**save, 1289****Save as image, 811****Saving files,**

- encoding of, 792

schema, 1184

schema, 1184

- also see XML Schema, 868
- assigning to DB XML, 952
- converting to UML, 878
- create DB based on schema, 975
- Design view, 992
- documentation, 72
- Documentation font, 1065
- management and assignment in IBM DB2 databases, 948
- see XML Schema, 42
- settings, 1041

Schema Design menu, 884**Schema Design View,**

- Display all globals, 896
- Display diagram, 896
- zoom feature, 896

Schema editing,

- content models, 216

Schema fonts, 1065**Schema Manager,**

- CLI Help command, 316
- CLI Info command, 317
- CLI Initialize command, 317
- CLI Install command, 318
- CLI List command, 318
- CLI overview, 316
- CLI Reset command, 319
- CLI Uninstall command, 320
- CLI Update command, 321
- CLI Upgrade command, 321
- how to run, 310
- installing a schema, 314
- listing schemas by status in, 312
- overview of, 307
- patching a schema, 314
- resetting, 315
- status of schemas in, 312
- uninstalling a schema, 315
- upgrading a schema, 314

Schema Overview, 42

- and Content Model View, 204, 205
- and global comments, 205
- and line display of global comments, 205
- editing in, 205
- icons in, 205
- sorting components in, 205

Schema Subsets, 327, 903, 904**Schema View, 198**

- Components entry helper, 252, 258
- configuring the view, 51
- Details entry helper, 256
- entry helpers, 252
- moving back and forward, 273

Schema View, searching in,

- see Find in Schemas, 348

SchemaAgent,

- connect to server from XMLSpy, 901
- disconnect from server, 902
- display schemas in, 902
- extended validation, 902
- opening schemas from XMLSpy, 345
- working with, 340, 341, 345

SchemaAgent in XMLSpy, 337**SchemaAgent Server,**

- connecting to, 338

SchemaDocumentationDlg,

- AllDetails, 1346
- Application, 1346
- IncludeAll, 1348
- IncludeAttributeGroups, 1348
- IncludeComplexTypes, 1349
- IncludeGlobalElements, 1349
- IncludeGroups, 1350
- IncludeIndex, 1350
- IncludeLocalElements, 1351
- IncludeRedefines, 1351
- IncludeSimpleTypes, 1351
- OptionsDialogAction, 1352
- OutputFile, 1352
- OutputFileDialogAction, 1353
- OutputFormat, 1353
- Parent, 1353
- ShowAnnotations, 1354
- ShowAttributes, 1354
- ShowChildren, 1354
- ShowConstraints, 1355
- ShowDiagram, 1355
- ShowEnumerations, 1355
- ShowNamespace, 1356
- ShowPatterns, 1356
- ShowProgressBar, 1356
- ShowProperties, 1356
- ShowResult, 1357
- ShowSingleFacets, 1357
- ShowSourceCode, 1357
- ShowType, 1358

- SchemaDocumentationDlg,**
 - ShowUsedBy, 1358
- Schemas,**
 - in memory, 883
 - looking up via catalogs, 333
 - managing for IBM DB2, 949
- Schemas and catalogs, 331**
- Schemas, finding in,**
 - see Find in Schemas, 348
- Script language, 1073**
- Scripting, 1073**
- Scripting Editor,**
 - overview, 1092, 1094
 - starting, 1007
- Scripts in XSLT/XQuery,**
 - see under Extension functions, 1629
- Scroll headers in Grid View, 147**
- Search,**
 - see Find, 818
- Searching in schemas,**
 - see Find in Schemas, 348
- Select All command, 812**
- Sequence compositor,**
 - using, 45
- Settings, 121, 1040**
 - overview of, 40
 - scripting, 1073
 - XSLT Debugger, 919
- Settings for file comparison, 1015**
- SharePoint® Server, 844**
- Shortcut, 1027**
 - assigning/deleting, 1027
 - show in tooltip, 1036
- Shortcuts, 280**
- Show curr. exec. nodes,**
 - XSLT debugger, 916
- Show large markup, 460, 463**
- Show mixed markup, 460, 463**
- Show small arkup, 463**
- Show small markup, 460**
- Sibling groups in Grid View, 192**
- Side-by-side, 1055**
- Simple type,**
 - assertions on, 258
 - defining facets of, 258
 - enumerations of, 258
 - in schema definitions, 57
 - patterns of, 258
 - sample values of, 258
- Simple type derivations, 256**
- Simple types,**
 - anonymous, 208
 - global, 208
 - named, 208
- Small markup (in Authentic View), 928**
- Smart Fix for XML Schemas, 262**
- Smart Restrictions, 267**
- SOAP Debugger,**
 - in Visual Studio .NET, 771
- Software product license, 1665**
- Sorting in Tables (XML Grid View), 855**
- Source control, 1074**
 - add to source control, 833
 - changing provider, 839
 - checking out, 830
 - enabling, disabling, 828
 - get latest version, 829
 - getting files, 829
 - installing a source-control plug-in, 742
 - open project, 827
 - properties, 838
 - refresh status, 839
 - removing from, 834
 - sharing from, 834
 - show differences, 837
 - show history, 836
 - supported providers, 827
 - undo check out, 832
- Source control manager, 839**
- Source folding in Text View, 133**
- Spelling checker, 1000**
 - custom dictionary, 1000
- Spelling options, 1003**
- Splash screen, 1055**
- Split View in Grid View, 160**
- Split View in Text View, 143**
- SPP file locations, 823**
- SPS,**
 - assigning to new XML file, 782
- SPS file,**
 - assigning to XML file, 922
- SPS tables,**
 - editing dynamic tables, 460
- SPS tables in Authentic View,**
 - usage of, 477
- SpyProject,**

SpyProject,

- CloseProject, 1359
- ProjectFile, 1360
- RootItems, 1360
- SaveProject, 1360
- SaveProjectAs, 1360

SpyProjectItem,

- ChildItems, 1361
- FileExtensions, 1361
- ItemType, 1361
- Name, 1361
- Open, 1361
- ParentItem, 1362
- Path, 1362
- ValidateWith, 1362
- XMLForXSLTransformation, 1362
- XSLForXMLTransformation, 1362
- XSLTransformationFileExtension, 1362
- XSLTransformationFolder, 1363

SpyProjectItems,

- AddFile, 1363
- AddFolder, 1363
- AddURL, 1364
- Count, 1364
- Item, 1364
- RemoveItem, 1364

SQL Azure, 662**SQL Editor,**

- creating query in, 944
- description of, 941
- in Database Query window, 941

SQL Server,

- connecting through ADO, 615
- connecting through ADO.NET, 621
- connecting via JDBC, 631
- manage XML Schemas, 954

SQLite,

- connecting natively, 638
- disable foreign keys, 638
- setting up a connection (Windows), 638

Start,

- XSLT debugger, 915

Start group,

- add (context menu), 1036

Static (SPS) tables in Authentic View,

- usage of, 477

Status Bar, 119**Step into,**

- XSLT debugger, 916

Step out,

- XSLT debugger, 916

Step over,

- XSLT debugger, 916

Stop,

- XSLT debugger, 915

Strip whitespace, 812**Structured text, 1047****Style, 1063****Stylesheet PI, 913, 914****StyleVision, 879**

- for editing StyleVision Power Stylesheet, 922

StyleVision Power Stylesheet,

- assigning to XML file, 922
- editing in StyleVision, 922

Support Center, 1088**Support options, 124****Sybase,**

- connecting through JDBC, 686

Syntax checking of JSON documents, 515, 520**Syntax coloring,**

- for XQuery, 378

Syntax-coloring, 1043, 1055**System DSN,**

- setting up, 628

T

Tab characters, 1041**Tab size,**

- and pretty-printing, 995
- setting, 995

Table,

- build automatically, 1043

Table Display commands (JSON Grid View), 866**Table Display commands (XML Grid View), 855****Table Display of JSON Grid View,**

- editing in, 167
- import/export to spreadsheets, 167

Table Display of XML Grid View,

- editing in, 163
- import/export to spreadsheets, 163

Table View, 1047

- how to use, 93

Tables,

Tables,

- editing dynamic (SPS) tables, 460
- in Authentic View, 451

Tables in Authentic View,

- icons for editing XML tables, 482
- usage of, 477
- using SPS (static and dynamic) tables, 477
- using XML tables, 478

Tables in Grid View,

- copying as TSV or XML, 192

Technical Information, 1661**Technical Support, 1088****Template files,**

- for new documents, 782

Template XML File,

- in Authentic View, 447

Templates,

- of XML documents in Authentic View, 921

Templates Window,

- in XSLT/XQuery Debugger, 414

Teradata,

- connect through JDBC, 688
- connect through ODBC, 690

terminate, 1188**Text,**

- editing in Authentic View, 472
- find and replace, 818
- finding in document, 812
- formatting in Authentic View, 472
- pretty-printing, 812

Text file,

- export of XML data to, 978
- import as XML, 961

Text view, 130, 991

- and commenting in XML documents, 287
- and empty lines in XML documents, 287
- auto-complete enable/disable, 1047
- bookmarks in, 133
- editing in, 82
- Entry helpers in, 142
- font properties, 131
- formatting of text, 131
- indentation, 131
- indentation in, 133
- intelligent editing features, 136
- keyboard shortcuts, 144
- line numbering in, 133
- schema fonts, 1065

- source folding in, 133

- special editing features for XML documents, 287
- Split View in, 143

- word-wrapping, 131

Text View Settings dialog, 995**TextImportExportSettings,**

- DestinationFolder, 1365
- EnclosingCharacter, 1365
- Encoding, 1366
- EncodingByteOrder, 1366
- FieldDelimiter, 1366
- FileExtension, 1366
- HeaderRow, 1366
- ImportFile, 1366

Theme selection for XMLSpy in Eclipse, 778**Toolbar, 119, 1024**

- activate/deactivate, 1024
- add command to, 1023
- add macro to, 1033
- create new, 1024
- reset toolbar & menu commands, 1024
- show large icons, 1036

Tools,

- see also External applications, 1026

Tools menu, 999**Tooltip, 1036**

- show, 1036
- show shortcuts in, 1036

Trace points in XPath/XQuery Debugger, 428**Trace Window, 406**

- in XSLT/XQuery Debugger, 416

Tracepoint,

- dialog box, 918

Tracepoints, 416

- using in XSLT/XQuery Debugger, 406

Transformation,

- see XSLT transformation, 908

Trusted locations for Authentic scripts, 930**TSV,**

- copying Grid View tables as, 192

Turn off automatic validation, 1043**type,**

- extension in XML document, 79

U

UCS-2, 1046

UML,

converting schemas to, 878

Undo command, 804

Unicode support,

in Altova products, 1662

Unnamed element relationships,

MS SQL Server schema settings, 900

Unsaved changes, 1041

Unselected, 994

Update Entry Helpers command, 863

URL, 1191, 1289, 1298, 1299

sending by e-mail, 798

User DSN,

setting up, 628

User interface,

configure using plug-in, 1120

User interface description, 107

User manual, 22, 1079, 1083

User Reference, 781

UTF-16, 1046

V

Validate on modification command, 863

Validating,

XML documents, 87

Validating XML documents, 285

Validation, 121, 857

assigning DTD to XML document, 868

assigning XML Schema to XML document, 869

of related schemas using SchemaAgent, 345

WSDL files, 862

Validation messages, 113

Validation of XML Schemas, 262

Validation settings, 1041

Validator,

in Altova products, 1661

Value templates (XSLT 3.0),

XPath intelligent editing in, 363

Variables in XPath/XQuery Debugger, 428

Variables Window,

in XSLT/XQuery Debugger, 413

VBScript,

scripting with XMLSpy, 1092

View,

Browser view, 993

Collapse, 993, 994

Enhance Grid view, 992

Expand, 993, 994

Go to File, 995

Go to line/char, 995

Optimal widths, 994

Schema Design view, 992

Text View, 991

View menu, 991

Visual Studio,

adding the XMLSpy ActiveX Controls to the toolbox, 1481

Visual Studio .Net,

and XMLSpy, 767

and XMLSpy Debuggers, 771

and XMLSpy differences, 769

VS .NET,

and XMLSpy Integration Package, 768

W

WADL,

using for HTTP requests, 589

Watch expressions in XPath/XQuery Debugger, 428

Watch for changes, 1041

Web Server, 1088

Well-formed test of JSON documents, 515, 520

Well-formedness check, 856

for XML document, 87

Well-formedness of XML documents, 285

Whitespace,

removing, 812

Whitespace handling, 296

Whitespace markers, 995

Window menu, 1080

Windows,

arranging, 1080

auto-hiding, 107

cascading, 1080

floating, docking, tabbing, 107

managing display of, 107

Windows,

- support for Altova products, 1661
- tiling, 1080
- turning display on/off, 1080

Word 2007, 278, 595**Word 2007+ output,**

- generating in Authentic View from PXF file, 930

Word document,

- import as XML, 969

Word wrap,

- enable/disable, 994

Word-wrapping in Text View, 131**Wrap,**

- word wrap enable/disable, 994

Wrap in Element command,

- in Grid View, 854

WSDL,

- using for HTTP requests, 589

WSDL files,

- extensibility elements, 862
- Validation, 862

X

XInclude,

- inserting in Grid View, 807
- inserting in Text View, 807
- inserting in XML document, 287

XML,

- convert XML instance to/from JSON/YAML instance, 984
- Oasis catalog, 857
- spelling checker, 1000

XML data,

- exporting to database, 981
- exporting to text file, 978

XML DB,

- loading new data row into Authentic View, 923
- loading new XML data row, 485

XML Diff,

- comparing directories, 1012
- comparing files, 1008, 1015

XML document,

- assigning to XSLT stylesheet, 914
- browse Oracle XML Db, 959
- creating new, 77
- editing in Text View, 82

- generating from DTD, 323

- generating from XML Schema (Enterprise and Professional editions), 326

- opening in Authentic View, 447

XML document creation,

- tutorial, 77

XML documents, 282

- and commenting in Text View, 287

- and empty lines in Text View, 287

- and XPath expression of a node, 287

- and XQuery, 300

- assigning schemas (incl. DTDs), 285

- automatic validation, 283

- automating XQuery executions of, 300

- automating XSLT transformations of, 300

- checking validity of, 87

- checking well-formedness, 285

- converting to and from YAML, 582

- default views of, 283

- editing in Authentic View, 291

- editing in Grid View, 290

- encoding of, 305

- evaluating XPath expressions on, 305

- generating schemas from, 305

- importing and exporting text, 305

- inserting file paths in, 287

- inserting XInclude, 287

- opening, 283

- saving, 283

- searching and replacing in, 305

- Text View editing features for, 287

- transforming with XSLT, 300

- validating, 285

XML file,

- generate from DTD or XML Schema, 879

XML Grid View,

- see Grid View, 146, 290

XML Import,

- based on schema, 974

XML menu, 853**XML Parser,**

- about, 1661

XML Schema, 42, 868, 884

- <alternative> element, 230

- adding components, 45

- adding elements with, 50

- also see Schema, 868

- assigning to DB XML, 952

XML Schema, 42, 868, 884

- assigning to XML document, 869
- configuring Content Model View, 893
- configuring the view, 51
- content model diagram, 887
- convert to/from JSON Schema, 987
- converting to DTD, 874
- creating a basic schema, 42
- creating a new file, 42
- defining namespaces in, 44
- editing content models, 216
- generate outline XML file from, 879
- generating documentation of, 887
- generating from DTD (Enterprise and Professional editions), 323
- generating from XML document, 872
- global components, 208
- go to definition in from XML document, 871
- go to from XML document, 871
- management and assignment in IBM DB2 databases, 948
- managing for IBM DB2, 949
- menu commands related to, 868
- modifying while editing XML document, 96
- MS SQL Server extensions, 899
- MS SQL Server schema settings, 900
- namespaces settings in Schema Design View, 884
- navigation in design view, 70
- Oracle extensions, 897
- Oracle schema settings, 898
- settings in Schema Design View, 884
- Smart Fix, 262
- tutorial, 42
- validation, 262

XML schema definitions,

- advanced, 57

XML Schemas, 306

- and global resources, 285
- converting to DTD (Enterprise and Professional editions), 326
- editing in Grid View (Enterprise and Professional editions), 326
- editing in Schema View (Enterprise and Professional editions), 326
- editing in Text View, 326
- generating XML document from, 326
- plus DTDs, 285

XML Signature, 924**XML signatures, 494****XML tables in Authentic View,**

- icons for editing, 482

- usage of, 478

XML text from external sources,

- adding quickly to document, 298

xml:base, 272**xml:id, 272****xml:lang, 272****xml:space, 272****XML-Conformance, 1043****XMLData,**

- AppendChild, 1374
- EraseAllChildren, 1375
- EraseCurrentChild, 1376
- GetChild, 1377
- GetChildKind, 1378
- GetCurrentChild, 1378
- GetFirstChild, 1379
- GetNextChild, 1380
- HasChildren, 1381
- HasChildrenKind, 1381
- InsertChild, 1382
- IsSameNode, 1383
- Kind, 1383
- MayHaveChildren, 1384
- Name, 1384
- Parent, 1384
- TextValue, 1385

XMLSchemas,

- flattening included schemas, 327, 904
- including other schemas in, 327
- splitting into subsets, 903

XMLSpy, 781

- features, 124
- help, 124
- integration, 1480
- plug-in registration, 1119

XMLSpy API,

- documentation, 1134
- overview, 1135

XMLSpy Debugger perspectives in Eclipse, 780**XMLSpy Enterprise Edition,**

- user manual, 22

XMLSpy in Eclipse, 772**XMLSpy Integration Package, 768****XMLSpy perspective in Eclipse, 775****XMLSPY plug-in, 1119****XMLSpy Plugin for Eclipse,**

- see Integration Package for Eclipse, 773

- XMLSpy Plugin for VS .NET,**
 - installing, 768
- XMLSpyCommand,**
 - in XMLSpyControl, 1521
- XMLSpyCommands,**
 - in XMLSpyControl, 1523
- XMLSpyControl, 1524**
 - documentation of, 1480
 - examples of integration at document level, 1488
 - integration using C#, 1488
 - object reference, 1520
- XMLSpyControlDocument, 1532**
- XMLSpyControlPlaceHolder, 1539**
- XMLSpyDocumentEditor,**
 - MarkUp View, 1416
- XMLSpyLib, 1134, 1135**
 - Application, 1172
 - AuthenticDataTransfer, 1194
 - AuthenticRange, 1199
 - AuthenticSelection (obsolete), 1398
 - AuthenticView, 1229
 - CodeGeneratorDlg, 1248
 - DatabaseConnection, 1254
 - Dialogs, 1261
 - DocEditEvent (obsolete), 1385
 - DocEditView (obsolete), 1400
 - Document, 1264
 - Documents, 1295
 - DTDSchemaGeneratorDlg, 1299
 - ElementList, 1304
 - ElementListItem, 1305
 - ExportSettings, 1306
 - FileSelectionDlg, 1308
 - GenerateSampleXMLDlg, 1322
 - GridView, 1328
 - ProjectItem, 1360
 - SchemaDocumentationDlg, 1345
 - SpyProject, 1359
 - SpyProjectItems, 1363
 - TextImportExportSettings, 1365
 - XMLData, 1373
- XML-Text, 1047**
- XPath,**
 - evaluating, 115
 - generating of a node in an XML document, 287
- XPath 1.0,**
 - in XPath Evaluator, 856
- XPath 2.0,**
 - in XPath Evaluator, 856
- XPath Evaluator,**
 - usage, 856
- XPath intelligent editing, 363**
- XPath of selected node in XML document,**
 - copying to the clipboard, 807
- XPath to selected node, 459**
- XPath Window, 115**
- XPath/XQuery expressions,**
 - building in XPath/XQuery Window, 436
 - debugging, 428
 - evaluating, 422
 - evaluating and debugging, 419
 - for JSON documents, 439
 - in XPath/XQuery Window, 442
- XPath/XQuery Window, 419, 420**
- XPaths,**
 - setting for tracepoints, 406
- XPath-Watch Window,**
 - in XSLT/XQuery Debugger, 413
- XPointer,**
 - generating of a node in an XML document, 287
- XPointer of selected node in XML document,**
 - copying to the clipboard, 807
- XQuery, 384**
 - DB support, 394
 - document validation, 384
 - editing in Text View, 374
 - entry helpers, 378
 - execution, 384
 - Extension functions, 1629
 - for querying XML databases, 394
 - functions for IBM DB2, 394
 - intelligent editing features, 380
 - opening file, 377
 - passing variables to the XQuery document, 910
 - syntax coloring, 378
- XQuery Debugger,**
 - see XSLT/XQuery Debugger, 399
- XQuery Execution, 385, 913**
- XQuery expressions for JSON, 567**
- XQuery files,**
 - setting file extensions in XMLSpy, 377
- XQuery options, 1071**
- XQuery Update, 385**
 - previewing, 387
 - PUL, 387
- XQuery Update Facility, 387**

XQuery Update in XMLSpy, 387

XQuery Update options, 1071

XSD 1.0 and 1.1,

editing modes, 200

XSD mode, 200

XSD validation, 262

xsi:type,

usage, 79

XSL,

see XSLT, 914

XSL Outline, 367

XSL Outline window, 116, 368

XSL transformation,

see XSLT, 98

XSL/XQuery menu, 906

xsl:call-template, 368

XSL:FO,

and XSLT transformations, 365

xsl:param, 368

xsl:with-param, 368

XSLT, 995

and batch transformations, 365

auto-completion in Text View, 363

documents, 363

entry helpers for, 363

Extension functions, 1629

functionality in XMLSpy, 362

modifying in XMLSpy, 100

processor, 1068

transformations in XMLSpy, 365

validating, 363

XSLT Debugger,

breakpoints/tracepoints dialog box, 918

debug windows, 919

enable/disable breakpoint, 917

enable/disable tracepoint, 917

end debugger session, 915

in Visual Studio .NET, 771

insert/remove breakpoint, 917

insert/remove tracepoint, 917

restart debugger, 915

settings, 919

show curr. exec. nodes, 916

start debugger, 915

step into, 916

step out, 916

step over, 916

stop debugger, 915

XSLT document structure, 116

XSLT documents,

and Info window, 371

editing and managing with XSL Outline, 367

XSLT functions,

in XSL Outline window, 368

XSLT parameters,

passing to stylesheet via interface, 910

XSLT stylesheet,

assigning to XML document, 913

assigning XML document to, 914

opening, 914

XSLT stylesheet for FO,

assigning to XML document, 914

XSLT templates,

in XSL Outline window, 368

XSLT transformation, 907, 908

assigning XSLT file, 98

in XMLSpy, 99

to FO, 908

to PDF, 908

tutorial, 98

XSLT/XQuery Debugger, 400

breakpoints usage, 404

built-in templates, 414

Call Stack Window, 414

Context window, 412

description of interface, 400

description of mechanism, 400

features and usage, 399

Info Window, 415

information windows, 410

matched templates, 414

Messages Window, 416

named templates, 414

settings, 417

template modes, 414

template priority, 414

Templates Window, 414

toolbar icons, 402

Trace Window, 416

tracepoints usage, 406

Variables Window, 413

XPath-Watch Window, 413

XSLT/XQuery debugging,

files used, 399

Y

YAML, 574

- convert to/from JSON, 990
- convert YAML instance to/from XML instance, 984

YAML document,

- generating from JSON schema, 581

YAML documents,

- converting to and from JSON, 582
- converting to and from XML, 582
- creating, 575
- font colors of, 577
- in Text View, 577
- indentation in, 577
- locator expressions for nodes in, 577
- pretty printing, 577
- text folding in, 577
- validating, 575

Z

ZIP files, 278, 595

- creating in Archive View, 601
- editing in Archive View, 601

Zoom feature,

- in Schema Design View, 896

Zooming in Text View, 133